

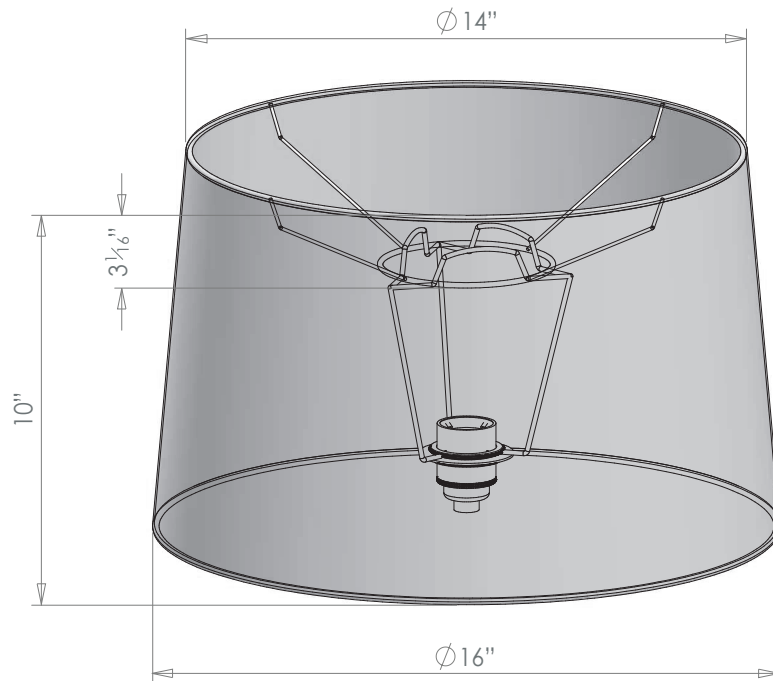

HECTOR FINCH

SHADE 15



PRODUCT CODE SHD15

CATEGORY: LAMPSHADES

FITTING TYPE

Edison Screw Duplex with Shade Carrier

SUITABLE FOR

Vellum Table Lamp (TL158), Shagreen Table Lamp (TL83), Cactus Table Lamp Small (TL172S), Ellipse Incalmo Table Lamp (TL182), Mala Table Lamp Medium Clear Honeycomb (TL143M), Mala Table Lamp Medium Ice Blue Honeycomb (TL193M) and Mala Table Lamp Medium Smoke Grey Honeycomb (TL138M)

CARD OPTIONS

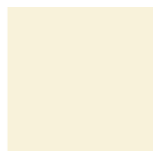

China White

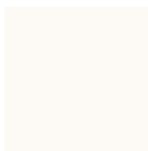

Snow White

SILK OPTIONS

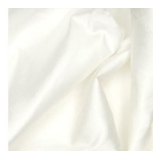

Porcelain

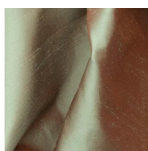

Thyme

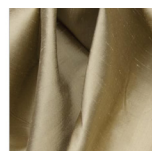

Almond

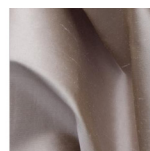

Zinc



Slate

LINEN OPTIONS



Oyster



Naturale