

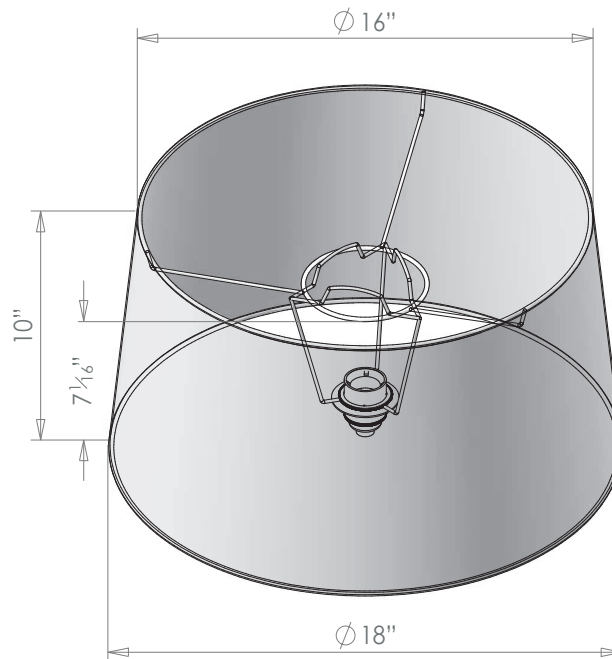

HECTOR FINCH

SHADE 29



PRODUCT CODE SHD29

CATEGORY: LAMPSHADES

FITTING TYPE

Edison Screw Duplex with Shade Carrier

SUITABLE FOR

Cactus Table Lamp, Large (TL172L)
Mala Table Lamp Medium Smoke Grey Honeycomb (TL138M)
Mala Table Lamp Medium Ice Blue Honeycomb (TL139M)
Mala Table Lamp Medium Clear Honeycomb (TL143M)

CARD OPTIONS

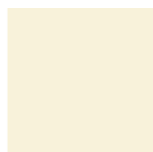

China White

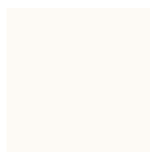

Snow White

SILK OPTIONS

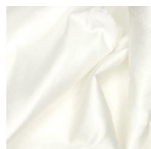

Porcelain

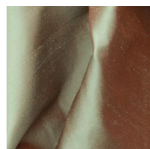

Thyme

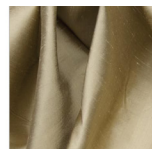

Almond

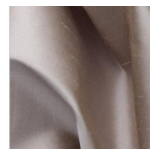

Zinc



Slate

LINEN OPTIONS



Oyster

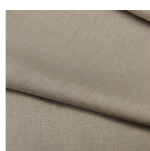

Naturale