

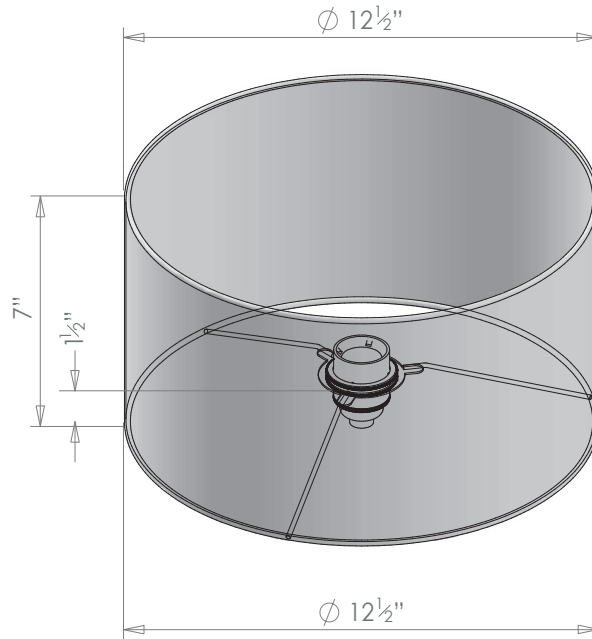

HECTOR FINCH

SHADE 30



PRODUCT CODE SHD30

CATEGORY: LAMPSHADES

FITTING TYPE

Edison Screw Gimble

SUITABLE FOR

Hector Table Lamp (TL3)

CARD OPTIONS

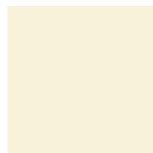

China White

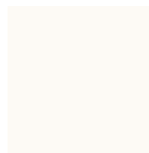

Snow White

SILK OPTIONS

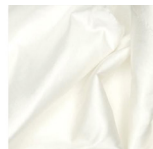

Porcelain

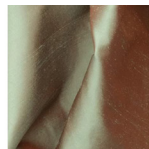

Thyme

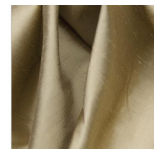

Almond

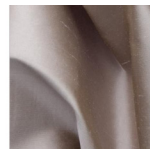

Zinc



Slate

LINEN OPTIONS



Oyster

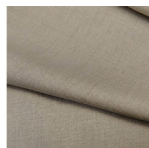

Naturale