



SPA DIVISION OF



Please read this owner's manual carefully as it is designed to provide you with instructions for the safe use of your new spa.

OWNER'S MANUAL



Save these instructions

US MANUAL

2022-06-28



TABLE OF CONTENTS

IMPORTANT SAFETY INSTRUCTIONS	3
INSTALLATION & QUICK START UP GUIDE	5
SPA OPERATION	7
OZONE GENERATOR INSTALLATION	8
PERSISTENT MEMORY RESET	10
ROUTINE MAINTENANCE	11
COVER MAINTENANCE & WINTERIZING YOUR SPA	12
UNDERSTANDING SPA CHEMICALS	14
SPECIALTY CHEMICALS	15
DISINFECTING AND SANITIZING CHEMICALS	16
TROUBLESHOOTING	17
DIAGNOSTIC MESSAGES	19
WARRANTY	20

IMPORTANT SAFETY INSTRUCTIONS

THIS OWNER'S MANUAL CONTAINS IMPORTANT SAFETY INSTRUCTIONS. READ AND FOLLOW ALL INSTRUCTIONS CAREFULLY AND KEEP THEM HANDY.

Most cities, counties, states/provinces and countries require permits for exterior construction and electrical circuits. In addition, some communities have safety codes requiring the property to be equipped with residential barriers such as fencing and/or self-closing gates to prevent unsupervised access by children to pools or hot tubs. Be sure to check with your local agencies for specific requirements.



WARNING

REDUCE THE RISK OF ELECTROCUTION

1. Never place an electric appliance within 5 feet or 1,54 metres of your spa.

REDUCE THE RISK OF CHILD DROWNING

1. Supervise children at all time.
2. Attach spa cover after each use.

REDUCE THE RISK OF OVERHEATING

1. Consult your physician before use if you are pregnant, diabetic, in poor health, or under medical care.
2. Exit immediately if uncomfortable, dizzy, or sleepy. Spa heat can cause hyperthermia and loss of consciousness.
3. Spa heat in conjunction with alcohol, drugs, or medication can cause loss of consciousness.

WHEN PREGNANT

1. Soaking in hot water during pregnancy may cause damage to the foetus. Consult your physician before use.
2. Do not enter spa if water is hotter than 100 °F (38°C).
3. Do not stay in spa for longer than 10 minutes.

WARNING: PEOPLE WITH INFECTIOUS DISEASES SHOULD NOT USE A SPA OR HOT TUB.

This warning must be posted before the spa is used.
If you need an additional or replacement sign,
contact Lumi-O | Innovaplas inc at 1-450-565-5544 extension 226 or by email at spaservice@innovaspa.com.

THIS SPA IS FOR RESIDENTIAL USE ONLY!
Any commercial or rental use will void the manufacturer's warranty.

Save these instructions



IMPORTANT SAFETY INSTRUCTIONS

READ AND FOLLOW ALL INSTRUCTIONS CAREFULLY.

1. When installing and using this equipment, basic safety precautions should always be followed.
2. **WARNING!** This product is provided with a ground fault interrupter (GFCI) as part of the attachment plug. The GFCI must be tested before each use. Press test button, "with the product operating push the test on GFCI, the product should now operate normally. When the product fails to operate in this manner, there is a ground current flowing indicating a possibility of an electric shock. Disconnect the power until the fault has been identified and corrected"
3. **WARNING! DO NOT PERMIT CHILDREN TO USE THIS PRODUCT UNLESS THEY ARE CLOSELY SUPERVISED AT ALL TIMES.**
4. A wire connector is provided on this unit to connect a minimum 8 AWG (8,4mm²) solid copper conductor between this unit and any metal equipment, metal enclosures or electrical equipment, metal water pipe, or conduit within 5 feet (1,5m) of the unit.
5. **DANGER!** Risk of electric shock or injury – (For cord-connected/convertible units)
 - a. Replace damaged cord immediately.
 - b. Do not bury cord.
 - c. Connect to grounded, grounding type receptable only.
6. **DANGER!** Risk of accidental drowning – Extreme caution must be exercised to prevent unauthorized access by children. To avoid accidents, ensure that children cannot use this spa unless they are supervised at all times.
7. **DANGER!** Risk of serious injury or death – The suction fittings in this spa are sized to match the specific water flow created by the pump. Should the need arise to replace the suction fittings or the pump, be sure that the flow rates are compatible. Never operate spa if the suction fittings are broken or missing. Never replace a suction fitting with one rated less than the flow rate marked on the original suction fitting.
8. **DANGER!** Risk of electric shock. Install at least 5 feet (1,5m) from all metal surfaces. As an alternative, a spa may be installed within 5 feet (1,5m) of metal surfaces if each metal surface is permanently connected by a minimum 8 AWG (8,4mm²) solid copper conductor to the wire connector on the terminal box that is provided for this purpose. Check with your city, state/province or country for regulations and/or safety codes that apply to your situation. Be sure to check with your local agencies for specific requirements in your area.
9. **DANGER!** Risk of electric shock – Do not permit any electric appliance, such as light, telephone, radio, or television, within 5 feet (1,5m) of a spa. Never operate any electric appliance from within your spa or if your body is wet.
10. **WARNING!** To reduce the risk of injury:
 - a. The water in a spa should never exceed 104°F (40°C). Water temperatures between 100°F (38°C) and 104°F (40°C) are considered safe for a healthy adult. Lower water temperatures are recommended for young children and when spa use exceeds 10 minutes.
 - b. Since excessive water temperatures have a high potential for causing foetal damage during the early months of pregnancy, pregnant or possibly pregnant women should limit spa water temperatures to 100°F (38°C). It is recommended to consult your physician before using a spa.
 - c. Before entering a spa, the user should measure the water temperature since the tolerance of water temperature-regulating devices varies.
 - d. The use of alcohol, drugs, or medication before or during spa use may lead to unconsciousness with the possibility of drowning.
 - e. Obese persons and persons with a history of heart disease, low or high blood pressure, circulatory system problems, or diabetes should consult a physician before using a spa.
 - f. Persons using medication should consult a physician before using a spa since some medication may induce drowsiness while other medication may affect heart rate, blood pressure, and circulation.
 - g. **Hyperthermia** – An extended stay in excessive water temperatures may induce hyperthermia. Hyperthermie occurs when the internal temperature of the body reaches a level several degrees above the normal body temperature; i.e. 98,6°F (37°C). The symptoms of hyperthermia include : dizziness, lethargy, drowsiness and fainting. The effects of excessive hyperthermia include :
 1. Failure to perceive heat.
 2. Failure to recognize the need to exit the spa.
 3. Unawareness of impending hazard.
 4. Damage to the foetus in pregnant women.
 5. Physical inability to exit the spa.
 6. Unconsciousness and danger of drowning.



INSTALLATION AND QUICK START UP GUIDE

Follow these instructions for quick and easy start up of your new spa. If you have any questions concerning start up, contact your dealer or InnovaSpa (Lumi-O | Innovaplas inc) directly for help.

OUTDOOR INSTALLATION

If you are going to install your spa outdoors, select a solid, level surface to place it on. The bottom of your spa is totally protected and it will not rot. Special preparation, such as a concrete pad or wood deck, is not mandatory, although they make very suitable bases. If installing your spa on a wood deck, ensure that the deck is built to code and that it will withstand the filled weight of the spa. When full, your spa weighs approximately 90 lbs (41kg) per square foot. Ensure that you do not install your spa underneath overhead power lines.

INDOOR INSTALLATION

If you are going to install your spa indoors, you should ensure that your doorway is at least 36 inches (91 cm) wide. The location where you intend to place your spa should be equipped with adequate ventilation, to remove chemical odors and added humidity, and adequate drainage to handle splashing and in case of a spa leak. It is not recommended to install your spa above a ground level floor.

INSTALLATION

- CONNECTING THE ELECTRICITY:** If you plan to operate your spa using a 110 volt electrical supply, a 12' electrical cord, with attached GFCI, is already connected to your spa. It must be plugged into a dedicated 15 amp wall outlet. **DO NOT plug the cord into your electrical outlet until you have completed Step 4 and your spa is full of water. DO NOT use an extension cord.** If you plan to operate your spa using a 220 volt electrical supply, you will be required to install a 220 volt GFCI breaker and disconnect box. You will require a maximum 40 amp GFCI. It is recommended that you use a certified electrician to install your GFCI breaker and disconnect box and to connect your spa to your house electrical panel. The spa pack in the model is convertible and can be connected with a 110 volt or a 220 volt electrical power supply. Instructions to convert the spa pack are located on the inside of the spa pack cover. **Ensure that the 220 volt breaker is disconnected until you have completed Step 4 and your spa is full of water.**
- SETTING THE SPA IN PLACE:** Move your new spa to the location where it will be installed. Leave a minimum of 36 inches (91 cm) of space at each end of the spa. This ensures that you will be able to remove the end panels and you'll be able to access your spa equipment. Leave enough room on the side(s) of the spa to be able to take your cover off and put it back on without obstruction.
- ATTACHING THE ACCESSORIES:** Open the accessories box and remove the waterfall assembly. Lubricate the rubber O-ring with a bit of water and insert it into its housing on the top of the spa. Remove the four fork lift channel covers and the hardware kit. Following the instructions in the hardware kit, install the covers. **Do this before you fill the spa with water.** You may have to slightly lift the spa to position the covers in their proper place.
- CHECKING THE CONNECTIONS AND SETTINGS:** Remove the door at the end of the spa with the captain's chairs. To remove the door(s), remove the 4 screws located near the ground in each door. Check the unions to the pump and to the heater manifold to ensure that they are tight. Vibration during shipping may cause them to loosen. **Do not overtighten these unions with channel locks. You could crack or damage them.** It is also recommended that you check these unions regularly. Pump vibration can cause them to loosen and this can cause a leak. Ensure that the two slice valves are in their open positions and that they have shaft lock clips installed on the stems to prevent self-closing. Ensure that the shut off valve on the end of the drain hose assembly is closed. It is located in the end with the equipment. Remove the cover of the equipment pack by loosening the two screws at the front. Near the bottom of the circuit board, you will see a small red panel with 10 white DIP switches. These switches should be factory set; however, you should ensure that they are properly set as shown below. Replace the equipment pack cover after checking the settings

MODEL	110V										220V									
ON		X	X				X			X		X	X				X			
OFF	X			X	X	X		X	X		X			X	X	X		X	X	X
DIP #	1	2	3	4	5	6	7	8	9	10	1	2	3	4	5	6	7	8	9	10



INSTALLATION AND QUICK START UP GUIDE

5. **FILLING THE SPA:** To fill your spa, remove the filter cover and the filter cartridge by turning it counter clockwise. **If your source water contains metals, such as iron, it is recommended that you attach a pre filter to your garden hose. This will help to remove any precipitated metals and to make start up easier.** Put your garden hose into the threaded hole where the filter cartridge is located and begin to fill your spa through this hole. This will purge air from the water lines and it will make priming the pump easier. Fill your spa approximately 6 inches (15 cm) from the top of the spa. The level that you keep your spa water at will be determined by your personal use and preferences.
6. **PRIMING THE PUMP:** When your spa is full of water, plug the power cord into your wall outlet or switch your 220 volt GFCI breaker to the on position. The top side control display will sequence through a numbered test pattern. When you see the initials PR, press the jets button to start the pump. If there is air in the line and the pump sounds like it is straining, you may have to depress the jets button to off and on several times before the pump will start. Be aware that it may take a few minutes for the pump to prime and for water to start flowing. When your pump starts to flow, and the jets begin to operate, press either the temperature up or down arrow to exit priming mode.
7. **SETTING THE TEMPERATURE:** The top side control will display dashes until the current water temperature is detected and displayed. This may take up to one minute. To set your desired temperature, press either the temperature up or down arrow. The set temperature will begin to flash. To change the set temperature, press either the up or down arrow until you reach your desired setting. When the temperature reading stops flashing, your desired temperature is set.
8. **SETTING THE FILTER CYCLE:** Your spa should be factory programmed to circulate twice a day, 4 hours at a time. This setting should be sufficient for normal usage. Your first filter cycle begins 6 minutes after you connect power to your spa. The second cycle will begin 12 hours later. Your spa is capable of circulating for 1-8 hour intervals, twice a day. To ensure that the cycles are properly set or to change this setting, press either the temperature down or up arrow, then press the «Jets» icon. The top side control display should show F4. Press either the temperature up or down arrow to increase or decrease the filtration cycle time. Press the «Jets» icon to exit the filter cycle program.
9. **CONTROLLING THE TEMPERATURE:** If your spa is not operating in a filter cycle, but the water requires heating, the spa pump and the heater will turn on until the set water temperature has been reached. Both components will then shut off automatically. This prevents your water from cooling down. Your spa is also equipped with freeze protection. If the water temperature drops below 45°F (7°C), the pump will automatically turn on. It will turn itself off 4 minutes after the water temperature has risen back to 45°F (7°C). **IMPORTANT: Your spa automatically checks the water temperature for 1 minute, every 30 minutes, to increase the temperature if it has dropped. If you are operating your spa using a 110V electrical supply, the heater will disengage when your pump is turned on to high speed. If your set temperature has dropped during usage, the heater may not come on automatically when you change your pump from high speed to low speed. To turn the heater back on, decrease your set temperature to one (1) degree below the current temperature and wait for the display to stop flashing. After stopping, raise the set temperature back to your original setting. This should reengage the heater within one (1) minute.**



SPA OPERATION

JETS

Operating the jets is very simple. There is a “Jets” button on the top side control panel. Depress the button once and the spa will begin to operate on low speed. Depress the button a second time and the spa will turn on to high speed. Depress the button a third time and the spa will turn off. If the spa is in filter cycle or heat demand, it will continue to operate on low speed. Each jet is individually adjustable and the intensity can be increased or decreased for your desired comfort.

LED LIGHTING

There is a “Lights” button on the top side control panel. It controls the LED main light and the individual LED lights. You can set the lighting to several different colors and/or modes by slowly depressing the lights button off and on until your desired setting is reached.

AIR CONTROL

The spa jets can be operated with water only or with a water/air mix. There is a valve located beside the top side control panel. By turning this valve counter clockwise, air will begin to enter the spa water through the jets. Closing the valve by turning it clockwise will stop the air. **NOTE: Leave this valve in its closed position when the spa is not in use. This will prevent ambient air from entering and cooling the water, it will make heating the spa water more efficient and it prevents the pump from running continuously. TO AVOID SEAL DAMAGE, DO NOT OVERTIGHTEN THIS VALVE.**

WATERFALL

Your spa is equipped with a cascading waterfall. It will operate when your pump is operating. The intensity of the water flow can be adjusted by turning the on/off valve. **NOTE: Do not try to remove the waterfall assembly by grabbing and pulling the black deflector. It will break. Grab each end of the clear fixture and wiggle it back and forth.**

FILTER

The spa filter cartridge is located on the side of the spa under the filter cover. To remove the filter, simply remove the filter cover and turn the filter counter clockwise. To replace the filter, turn it clockwise to secure it in the spa. Your filter should be cleaned on a regular basis, depending on spa usage



OZONE GENERATOR INSTALLATION

Your spa was manufactured with “Ozone Ready” plumbing. To install an ozone generator, follow these instructions.

Your ozone generator kit should include the following components:

- ¼” ID tubing (min 8ft)
- ¼” kynar check valve
- ¼” x 3/8” kynar adapter
- 3/8” vinyl tube plug
- ½” hose clamp
- 8” zip tie (4 required)
- ¼” x 5/8” truss head mounting bolts with nuts (2 required)
- olive oil or liquid soap (to lubricate the barb fittings for easier connection to the tubing)

1. Disconnect the power to your spa.
2. Remove the door at the end of the spa below the top side control. The spa equipment is installed behind it (see fig. 1.1 on next page). Remove the insulation on the left side of the opening to make room to install the ozone generator and remove enough insulation from the top of the opening to expose the air manifold.
3. Cut a 2” piece of ¼” ID tubing. Lubricate the barbs on the air out end of the check valve and on the adapter and connect them together. The direction of air flow should be toward the adapter (see fig. 1.2 on next page). Blow into the barb on the check valve after the 2 pieces are connected to ensure there is flow through.
4. Take the ¼” ozone tubing and create a double Hartford loop in the center about 4” in diameter and secure it with wire ties (see fig. 1.3 on next page). Secure this loop to the airline manifold at the top of the spa, as high as it can go, using zip ties (see fig. 1.4 on next page).
5. You will see a piece of 3/8” ID airline tubing with a label that says OZONE with a direction arrow. This tubing goes from the air manifold to the lower right side jet of the left hand captain’s chair. Lubricate the barbs on the check valve/adapter assembly. Cut this line above the direction arrow label. If your spa is full of water, water may flow from the lower tube after you cut it. Insert the adapter into the lower tube with the arrow. Trim one end of the ozone tubing from the Hartford loop to length and connect it to the check valve barb. Do not make this line snug. Insert the 3/8” plug into the upper tubing line and secure it with the ½” hose clamp.
6. Measure the distance between the mounting holes on the ozone generator and drill 2 ¼” holes into the recessed lip on the left side of the opening. Mount the ozone generator with the bolt heads on the outside (see fig. 1.5 on next page). Lubricate the hose barb on the top of the ozone generator. Trim the second end of the ozone tubing from the Hartford loop to length and connect it to the ozone generator.

OZONE GENERATOR INSTALLATION



FIGURE 1.1

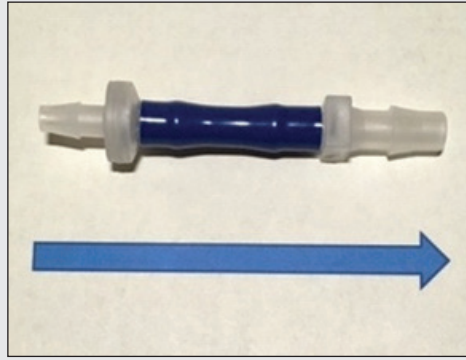

FIGURE 1.2

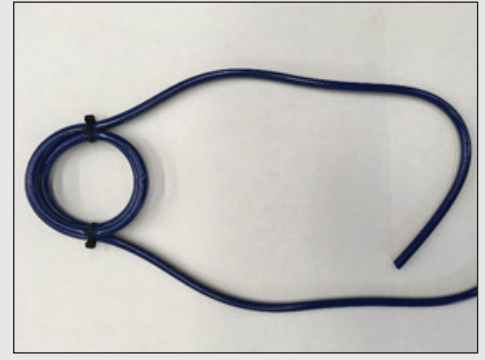

FIGURE 1.3



FIGURE 1.4



FIGURE 1.5

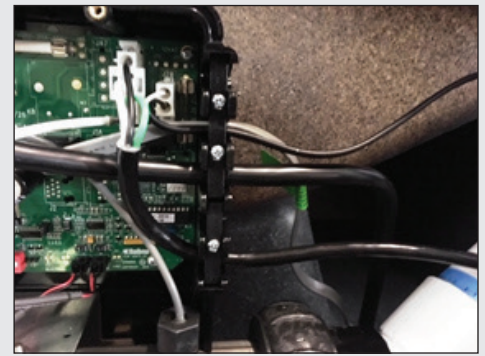

FIGURE 1.6

7. Loosen the screws at the top of the spa pack and remove the cover. Feed the ozone generator cord to the spa pack and connect it to J29 on the upper right side of the circuit board. Remove the cord restraint on the bottom right side of the spa pack and insert the ozone cord into an open location. Replace the restraint and the replace the spa pack cover (see fig. 1.6).
8. Reconnect the power to the spa. With the spa running on low speed, check to ensure there is a slight blue glow coming from the air access hole, usually on the bottom of the ozone generator. This indicates that it is on. Close the air control on the spa and ensure there is still a bubble mist entering the spa from the lower right side jet of the left side captain's chair, even though the other jets have stopped. Your installation is complete. Replace the insulation and the spa door.

IMPORTANT NOTES

1. The transfer of ozone into your spa water takes place through the right foot jet of the lounger. **DO NOT TURN THIS JET TO THE CLOSED POSITION.** This could cause excessive water pressure on the check valve and it could cause it to fail. Your spa could totally drain and your equipment could get damaged.
2. When the air control valve is closed, normally no air will enter the spa through the jets. When an ozone generator is installed, the jet dedicated to introducing the ozone into the water will aspirate any time the spa pump is running.

OZONE GENERATOR INSTALLATION

PRE INSTALLATION

1. The ozone generator or UV sterilizer must be 110V and approved for use on residential spas.
2. A Mazzei 784K, or equivalent, injector is required for the ozone generator installation.
3. The electrical cord must have an amp style, 4 pin, male connector with wire locations as follows:

Balboa ozone connector configuration for 120V 60Hz

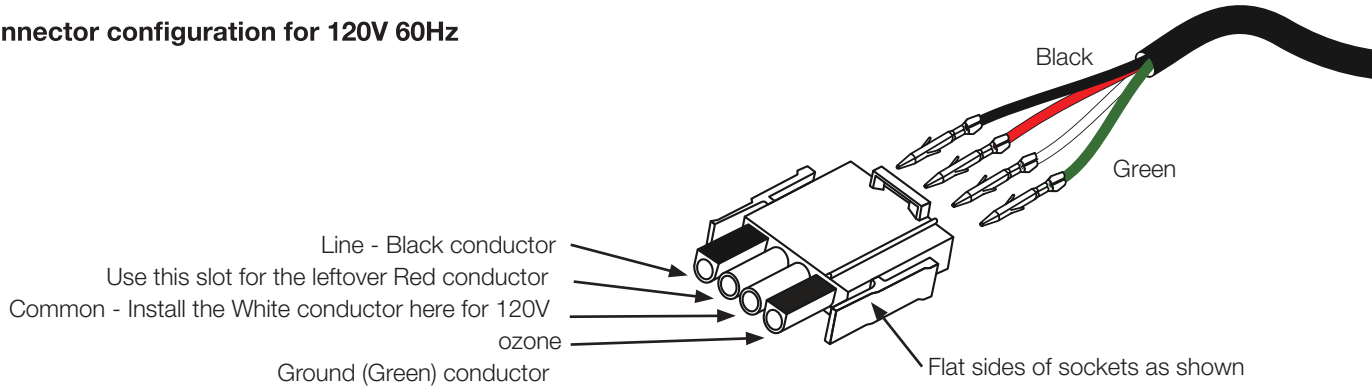

PERSISTENT MEMORY RESET

Any time you change a DIP switch, other than A1, you must reset persistent memory for your new DIP switch settings changes to take effect. If you do not reset Persistent Memory, your system may not function properly.

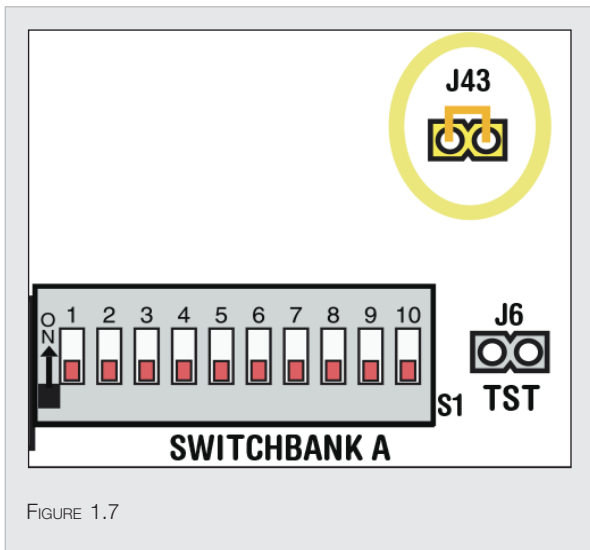

TO RESET PERSISTENT MEMORY

1. Disconnect power to the spa.
2. Remove and put the jumper across J43, covering both pins. (see fig. 1.7)
3. Connect power to the spa.
4. Wait until "PR" is displayed on the panel.
5. Disconnect power from the spa, again.
6. Remove jumper from J43 and replace.
7. Reconnect power to the spa.

FIGURE 1.7



ROUTINE MAINTENANCE

Your spa will require periodic maintenance to ensure that you maintain clean and healthy water, a safe spa and a clean and healthy spa environment. By performing regular maintenance, your spa will provide you with many trouble-free years of therapy and enjoyment.

FILTER

Your spa contains a filter cartridge that was designed to trap and remove particles from the spa water. This ensures that your water will remain crystal clear and pleasant to bathe in. You should remove and clean the cartridge periodically (twice a month) to keep it working effectively. Follow the steps below:

1. **Turn the power to your spa off** and remove the filter cover.
2. Remove the cartridge by turning it counter clockwise.
3. Pre clean the cartridge by rinsing it with your garden hose to remove most of the solid debris.
4. Using a recommended filter cleaning agent, pour the proper dose into a pail. Place the cartridge into the pail and add water until the cartridge is completely submersed. Leave the cartridge sitting in the pail for 12 hours. This will dissolve oils and greases from the cartridge.
5. After 12 hours, remove the cartridge from the pail and rinse it with your garden hose.
6. Put the cartridge back in the spa. Put the filter cover back into place and turn the power to your spa on. For sanitary reasons, never use the spa without an installed filter cartridge.
7. If you wish to use the spa while cleaning the cartridge, it is recommended that you have two cartridges and use them alternatingly. Life expectancy of filter cartridges is about two years, depending on spa usage.

BOTTOM DRAIN (SUCTION FITTING)

Your spa has a bottom drain that feeds water to the pump. It is equipped with a VGB-compliant cover located in the foot well of your spa. This cover traps hair and other large debris to prevent these contaminants from being sucked into the spa pump. It is recommended that you remove the debris from the cover on a weekly basis. Failure to do so could result in damage to your pump. Never operate your spa if the bottom drain cover is damaged or removed.

WATER REPLACEMENT AND CLEANING YOUR SPA

Depending on usage, your spa water should be replaced regularly. Follow the steps below :

1. Turn the power to your spa off and remove the filter cartridge. Clean or replace the cartridge.
2. Remove the access door at the end of the spa where the equipment is located.
3. Remove the drain hose from the equipment enclosure and attach your garden hose to the shutoff valve.
4. Direct the hose to a suitable location for the evacuation of water and open the shutoff valve. To accelerate drainage, use a submersible pump instead of the drain hose.
5. There will be a small amount of water left in the spa once it has been drained. It is recommended that you remove this water using a shop vacuum.
6. Clean the inner and outer surfaces of your spa using a mild detergent, warm water and a soft brush or cloth. Thoroughly rinse the detergent from the spa before you refill it. Never use cleaners that contain harsh abrasives or rubbing and buffing compounds. They may permanently damage your spa surfaces.
7. Refill the spa according to the instructions located in the «Installation And Quick Start Up Guide» of this manual.

COVER MAINTENANCE AND WINTERIZING YOUR SPA

Clean the outer surface of the cover using mild detergent, warm water and a soft brush or cloth. Thoroughly rinse the cover after cleaning. Never use cleaners that contain harsh abrasives or rubbing and buffing compounds as they may permanently damage your cover's surface.

If your spa is equipped with a vinyl cover and is exposed to sunlight, it is recommended to regularly apply a vinyl protector to prevent the vinyl from cracking or discoloring under the sun's UV rays.

Always leave the spa cover on your spa when it is not being used to prevent heat loss and reduce energy costs. The cover will prevent airborne contaminants from entering your spa and will help to prevent unauthorized access to the spa. Use the lock-down tabs to prevent unauthorized access to the spa and to prevent the wind from lifting the cover off. (see fig. 1.8)

WARNING! Sitting or standing on the cover of your spa will break it. During winter, you also need to remove snow buildup from the cover for the same reason.

WARNING! Always lift the cover by the grip handles and never drag the cover over rough surfaces as it will scuff or tear the vinyl.

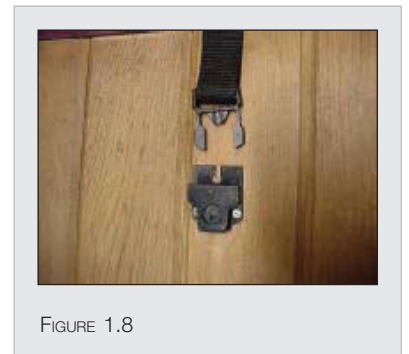

COVER CALLOUTS

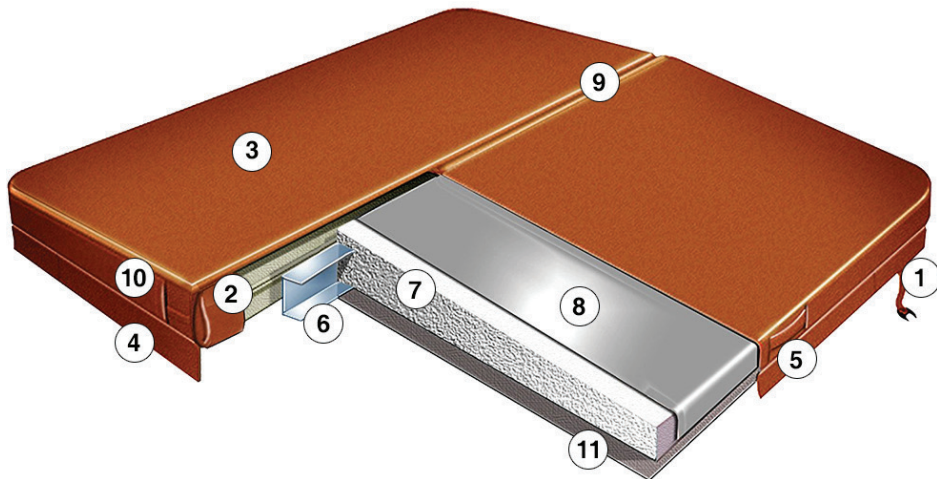

1. Lock-down tab
2. Double-stitched seams
3. Marine-grade vinyl
4. Cover skirt
5. Grip handle
6. Aluminum support channel
7. 1.5 lb density polystyrene insert
8. 6 mil chemical-resistant vapor barrier
9. Full length vapor hinge
10. Reinforced edges
11. Breathable underside insert protection

WINTERIZING YOUR SPA

It is highly recommended to use a professional to close your spa to prevent any damage due to improper winterizing.



COVER MAINTENANCE AND WINTERIZING YOUR SPA

IMPORTANT! Damage caused by improper winterizing is not covered under the manufacturer's warranty.

The following is a guideline to help you winterize your spa. It is imperative that you remove as much water from the spa, the plumbing lines and the equipment as you can to help prevent freeze damage.

1. Flush the spa lines and the equipment, if needed. In some areas, the water has high calcium and sometimes it precipitates out of solution and sticks to the inside of the spa, the plumbing and the equipment. Using a product like "Jet Clean" from Leisure Time Chemicals, or a similar product, flush your spa following the manufacturer's recommended directions.
2. Disconnect the power to the spa.
3. Remove the panel(s) where the equipment is located. If you did not do step 1, remove the filter cartridge from the spa. Drain your spa using the drain valve installed in the spa or with a submersible pump.
4. Using a wet vac, begin to loosen the unions on the intake, or front, of the pump and on the discharge end of the heater manifold. An automobile oil filter wrench is ideal to do this. Suck the water into the wet vac from both unions until the flow stops. After the unions have been disconnected, stick the wet vac into the pump front and the heater manifold and suck out as much excess water as you can.
5. Drain your wet vac and reverse it into a blower. Stick the hose end into the filter hole and over every jet to blow as much water out of the lines as possible.
6. Turn your wet vac back into a water vacuum and suck all water out of the spa and the equipment cavity.
7. Reconnect the unions to the front of the pump and to the heater manifold.
8. Using a turkey baster and a gallon of swimming pool or RV antifreeze, squirt antifreeze into each jet. Remove the union on the top (discharge side) of the pump and pour half of the remaining antifreeze into the pump. Reconnect the union to the pump.
9. Pour the remaining antifreeze into the filter hole.
10. If you are in a region that does not receive a lot of snow or if your spa is sheltered, replace the cover onto your spa and secure it using the attached buckles and safety straps to prevent it from blowing off in high winds. If you want to protect the outside of your spa from the elements when it is not being used, wrap it with a properly secured tarp or you can purchase a spa winter cover from your local spa dealer.

REINFORCING YOUR COVER IN HEAVY SNOW REGIONS

1. If you are in a heavy snow region, cut 2 pieces of 2x4 that extend from one end of the spa to the other end, but not longer than the spa.
2. Wrap the ends with duct tape to prevent them from scratching the top of the spa ledge.
3. Set the 2x4s on top of the spa from one end to the other. Set them as close to the edge of the spa as possible, but not past it.
4. Secure each end of the 2x4s to the spa using a piece of duct tape.
5. Cut a piece of ¼" plywood to lay on top of the 2x4s. Do not go past the edges of the spa.
6. Set the plywood on top of the 2x4s.
7. Set your cover on top of the plywood.
8. Secure the cover to the spa using safety straps. (Safety straps are available from your spa dealer)
9. Wrap the spa with a properly secured tarp or you can purchase a spa winter cover from your local spa dealer.



UNDERSTANDING SPA CHEMICALS AND HOW THEY ARE USED

As a new spa owner, it is very important that you learn and understand how to keep your spa water clean and healthy. This short guide was designed to give you a basic explanation of the most common chemicals used in spas and when they are needed. This information was designed to give you a simple understanding of spa chemicals and how, where, when and why they are used. It is recommended that you consult your spa dealer for more detailed information or if you need further assistance.

FILLING YOUR SPA

Although most spa makers have recommended filling instructions, some important things to remember are :

1. It is not recommended to use soft water to fill your spa. Soft water is aggressive and can attack metal fittings and heater elements.
2. If your water source contains metals such as iron and/or copper, it is recommended to use a pre-filter on the end of your garden hose to remove precipitated metals from the water before they have a chance to get into your spa.
3. You must remove the spa's filter cartridge and insert your garden hose directly into this opening. This will force air out of the water lines and make it easier for your pump to prime and start.

CHEMICAL CATEGORIES AND USAGE *

1. Water balance: These chemicals protect your spa and prevent damages caused by aggressive water.
2. Sanitizing : These chemicals protect bathers by destroying bacteria and viruses.
3. Specialty : These chemicals are used for preventive maintenance and water clarification.

* When using any chemicals, always refer to the manufacturer's recommendations for usage.

WATER BALANCE CHEMICALS

Water balance chemicals are extremely important because they prevent your spa water from becoming acidic/corrosive or alkaline/scale forming. This, in turn, prevents costly damage to your spa and its equipment. There are four parameters that lend themselves to determining balanced water. They include alkalinity, pH, calcium hardness and temperature. In a spa application, temperature is generally constant and as long as it is initially in range, calcium hardness usually does not need further adjusting. The two most important water balance parameters are alkalinity and pH.

1. Alkalinity – Alkalinity is the foundation of water balance. When in its proper range, it will help to keep the water's pH in range and to prevent erratic changes in the pH. Alkalinity should be checked and adjusted, initially, and then tested, and adjusted if needed, on a weekly basis.
2. pH - pH is an extremely important water balance parameter. If pH is low, your water is acidic and can attack metal components and heater elements resulting in corrosion to these parts. If pH is high, your water is alkaline or scale forming. As pH rises, calcium becomes less soluble in water. pH should be checked and adjusted, initially, and then tested, and adjusted if needed, on a weekly basis.



SPECIALTY CHEMICALS

Specialty chemicals address occasional water problems and help to maintain clean, clear water when a spa is heavily used. Whether you will or should use these chemicals will be based on the quality of your source water and how frequently your spa is used. Following is a summary of the most common specialty chemicals and when they should be used.

1. **Metal removers and stain preventers** – Many people have a well as their source water and quite often, this water contains dissolved metals such as iron and/or copper. If your water is in this category, you should use metal-treatment and stain-prevention chemicals in your spa. These chemicals will bind with the metals in your water, preventing them from precipitating from the water and causing stains.
2. **Enzymes** – Bathers introduce oils and greases into spa water; those normally originate from natural body oils, perspiration, artificial body oils such as moisturizers, cosmetics and other complex bather wastes. When excessive, they can cause scum lines and foul up filter cartridges. To help prevent build up of these oils and greases, you can add enzymes to your spa water. Enzymes help to break down oils and greases into smaller fragments so that they can be destroyed and removed through shock treatment with a non-chlorine oxidizer. If you experience visible oil and grease conditions on the water's surface and/or a continuous scum line, it is recommended to add enzymes on a regular basis.
3. **Clarifiers** – When a spa is heavily used, there can be a build up of microparticles in the water that are too tiny to get trapped by the filter. The water becomes cloudy. These negatively charged particles repel each other and as such they cannot bind together and be properly filtered. Clarifiers are positive ions that neutralize the negative charge of the microparticles which allows them to clump together into bigger particles that can be filtered out of the water. If your spa water is properly balanced and your spa filter is functioning properly, but you still have a cloudiness problem, you should add clarifier to your water.
4. **Defoamers** – Occasionally, foam may form on the surface of your spa water for various reasons: low calcium hardness, bather wastes, improperly rinsed filters, soap from bathing suits, etc. If persistent, check the water's calcium level and adjust if needed. Also, ensure that filters and bathing suits are well rinsed. A defoamer is a temporary fix and will not remove the source of the problem. Add 5 to 10 drops at a time.
5. **Biofilm** – A spa environment is conducive to the formation of microorganisms and bacteria. It's a warm and wet environment where dead organic compounds can thrive. When microorganisms attach themselves to a spa surface, they can begin to colonize if they are not removed and destroyed. If allowed to colonize, they will secrete a substance known as biofilm. This biofilm protects them from destruction by normal spa chemicals. When there is significant bacterial growth, a spa can begin to smell musty and swampy. The normal cure is to drain, clean and refill the spa. A product called Aqua finesse is now used in the industry and has proven itself capable of penetrating biofilm and destroying microorganisms and bacteria. Using Aqua finesse on a regular basis is good preventive maintenance.



DISINFECTING AND SANITIZING CHEMICALS

There are many different systems available to disinfect and sanitize your spa. The system that you choose should be geared to the frequency of usage of your spa and who is using it. Following are five traditional systems that address different preferences and usage parameters. You should choose the system that is best suited for you.

BROMINE

Bromine is a sanitizer that is best suited for use in spas. Unlike chlorine, bromine's effectiveness is not sharply reduced as pH rises. Just as chlorine's byproduct is called chloramine, bromamine is bromine's byproduct. But unlike chloramine, bromamine is an effective disinfectant that does not produce unpleasant odors. There are two traditional brominating systems. The first uses bromine tablets or caplets that are generally placed in a floating feeder to dissolve and create a bromine residual in the water. The water will require regular shocking. The second system requires the addition of bromine salt to the water. An oxidizer is then added, after each use, to produce a bromine sanitizer. This will sanitize and oxidize the water after each use.

CHLORINE

When it comes to sanitizers, chlorine is probably the best known. A small amount should be added to your water after every use. This will both sanitize the water and oxidize contaminants from it. The two (2) most popular forms are granular Di-Chlor and granular Lithium Hypochlorite. Both are very effective. You should not over chlorinate your spa. This could result in bleaching or staining of the polyethylene and these conditions **are not** covered under warranty.

BIGUANIDE

Unlike bromine and chlorine, biguanide is a non-halogen sanitizing compound. It is effective for people who have allergic reactions to halogen sanitizers like chlorine and bromine. It is odorless and does not irritate skin. Biguanide is not compatible with chlorine or bromine. Contact with these chemicals will leave gummy residues on your spa's surfaces. Also, biguanide is not effective in spas with heavy bather loads.

MINERAL PURIFIERS

Copper and zinc are very effective in killing bacteria and viruses in water. Minerals do not work as quickly as other sanitizers and cannot remove organic waste from the water. Although most metal-producing systems have inline chambers that use electrolysis to produce metal ions and introduce them into the water, mineral purifying sticks have become very popular and work extremely well with ozone.

SHOCK TREATMENT

One of the most important parts of a spa treatment is to shock or super chlorinate the water after each use. When a spa is used, bathers will leave oils, greases and ammonia from their sweat, as well as many other contaminants from their body, in the water. Unless removed right away, these contaminants will become food source for other microorganisms in the water and they can cause odors and unhealthy water. Shocking after each use will remove these contaminants and help to make your spa much easier to maintain.



TROUBLESHOOTING

If you are experiencing an operating problem, it is recommended to contact your spa dealer or a qualified service technician to arrange servicing. Some problems can be diagnosed and rectified with a simple action or procedure. Below are some common problems, possible causes and simple actions that may help to solve them.

THE CIRCUIT BREAKER IMMEDIATELY TRIPS WHEN THE SPA IS STARTED

1. If your spa is wired for a 220V electrical supply with a 40A max GFCI breaker, ensure that the wiring from the house panel to the breaker and from the breaker to the spa is done correctly. Occasionally, the white common wire is improperly connected and the breaker trips immediately.
2. If you are using the 110V GFCI cord supplied with the spa, ensure that the circuit that you have plugged it into is dedicated to the spa only and that no other appliances are using the same circuit. This could cause an amp overload and trip the breaker.

NEVER USE AN EXTENSION CORD.

3. The problem could be a defective breaker, component or heater element. It is recommended that a qualified technician perform this troubleshooting.

NOTHING OPERATES WHEN YOU CONNECT ELECTRICITY TO THE SPA

1. Check the breaker to ensure it hasn't tripped. If it is tripped, reset it and try again.
2. Using a voltmeter, check to ensure that there is power to the spa pack. This is done by removing the cover of the equipment pack. It is recommended that a qualified technician perform this troubleshooting.

THE PUMP LIGHT GOES ON, BUT THERE IS NO WATER FLOW TO THE JETS

1. Ensure that any gate valves located in the equipment enclosure are in the open position.
2. Ensure that the jets are in their open position.
3. Ensure that your filter is not dirty and causing a flow restriction.
4. The pump may not be properly primed. Push the «Jets» button several times. It may take several minutes for the pump to prime.

THE PUMP RUNS CONTINUOUSLY OR WILL NOT SHUT OFF WHEN THE «JETS» BUTTON IS DEPRESSED

1. The pump runs as long as there is a heat demand. Ensure that the air control valves are in their closed position when you are not using the spa. If they are open, they will allow cold, ambient air to enter your spa water, especially in cold weather, and the pump will continue to run to keep up with the heat demand.
2. Check the length of your filter cycle.
3. Even if you press the «Jets» button to turn it off, the pump will continue to operate on low speed if your spa requires heat or is in a filter cycle.

SPA WATER TEMPERATURE EXCEEDS SET TEMPERATURE AND WATER IS VERY HOT

1. **DO NOT ENTER THE SPA.** Remove the cover and allow the spa water to cool down.
2. In hot climates, spa water can overheat from high ambient air temperatures, direct sunlight on your spa or from heat transfer from the pump during filter cycles. Readjust your safety straps and place a small object between the cover and the spa to slightly wedge it open. This will help to keep the water cooler.

WATER LEVEL IN THE SPA IS DROPPING FASTER THAN NORMAL

1. If your spa has been used more than normal, it could be a result of more splashing and added evaporation.
2. Remove the access door to the equipment and inspect for water on the floor of the spa cavity. If there is water, check and ensure that your unions are properly tightened. Check your jets housings and plumbing to try to identify a plumbing leak.

It is recommended to contact your spa dealer or a qualified service technician for spa service.

TROUBLESHOOTING

MY WARRANTY HAS EXPIRED

InnovaSpa (Lumi-O | Innovaplas inc) will continue to provide service for your spa even after your warranty has expired via our customer care center at 1-450-565-5544, extension 226 or by email at spaservice@innovaspa.com.

DRAINAGE FREQUENCY

The frequency of draining your spa and cleaning or replacing your filter will be determined by your sanitation program. Consult your dealer for recommendations.

BLEEDING AIR FROM YOUR SPA

When draining and refilling your spa, air may enter the pump which will keep the water from flowing into it. Below are the steps to take to bleed an air-locked pump: See figure 1.9a or 1.9b

1. Turn off the GFCI breaker
2. Open the access door to the equipment enclosure.
3. Loosen a heater union until you hear the trapped air escape.
4. Once water drips out in a continuous stream, hand tighten the union until the water stops leaking.
5. Turn on the GFCI breaker.
6. Turn on all pumps to make sure that the pump starts and that there are no leaks.
7. Put the access door back on.



FIGURE 1.9a : HEATER UNION; LOOSEN UP TO BLEED AIR

or

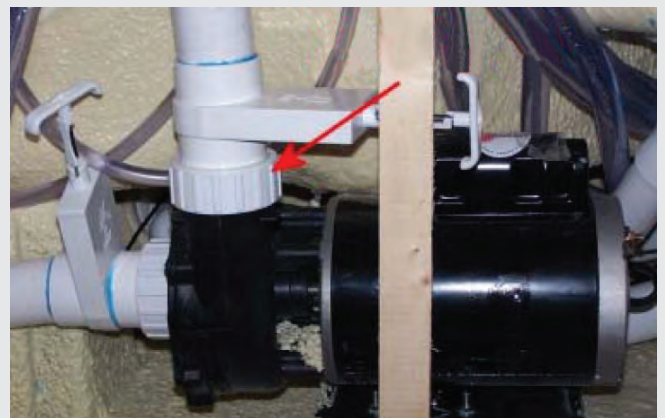

FIGURE 1.9b : PUMP UNION; LOOSEN UP TO BLEED AIR

DIAGNOSTIC MESSAGES

MESSAGE	MEANING	ACTION REQUIRED
	No message displayed. Power to the spa has been cut off.	The control panel will be disabled until power returns.
-- --	Temperature unknown	After the pump has been running for two minutes, the temperature will be displayed. Spa settings will be preserved until next start up.
HH	Overheat. The spas has shut down. One of the sensors has detected a 118°F (48°C) temperature at the heater.	Do not enter the water. Remove spa cover and allow water to cool. Once the heater has cooled, reset by pushing any button. If spa does not reset, shut off the power to the spa and call your spa dealer or a qualified service technician.
OH	Overheat. The spa has shut down. One of the sensors has detected that the spa water is 110°F (43°C).	Do not enter the water. Remove spa cover and allow water to cool. Once the heater has cooled, reset by pushing any button. If spa does not reset, shut off the power to the spa and call your spa dealer or a qualified service technician.
IC	Ice : Potential freeze condition detected.	No action required. The pump will automatically activate, regardless of spa status.
SA	Spa is shut down. The sensor that is plugged into the sensor "A" jack is not working.	If the problem persists, call your spa dealer or a qualified service technician. (May appear temporarily in an overheat situation and disappear when the heater cools.)
SB	Spa is shut down. The sensor that is plugged into the sensor "B" jack is not working.	If the problem persists, call your spa dealer or a qualified service technician. (May appear temporarily in an overheat situation and disappear when the heater cools.)
SN	Sensors are out of balance. If alternating with spa temperature, it may just be a temporary condition. If flashing by itself, spa is shut down.	If the problem persists, call your spa dealer or a qualified service technician.
HL	Significant difference between temperature sensors has been detected. This could indicate a flow problem	Check water level in spa. Refill if necessary. If the water level is okay, ensure the pump has been primed. If the problem persists, call your spa dealer or a qualified service technician.
LF	Persistent flow problems. (Displays on the fifth occurrence of "HL" message within 24 hours.) Heater is shut down, but other spa functions continue to run normally.	Follow action required for "HL" message. Heating capability of the spa will not reset automatically. Press any button to reset.
DR	Possible inadequate water, poor flow or air detected in the heater. Spa is shut down for 15 minutes.	Check water level in spa. Refill if necessary. If the water level is okay, ensure the pump has been primed. Press any button to reset; the spa will restart after 15 minutes. If the problem persists, call your spa dealer or a qualified service technician.
DY	Inadequate water detected in heater. (Displays on third occurrence of "DR" message.) Spa is shut down.	Follow action required for "DR" message. Spa will not automatically reset. Press any button to reset.

WARNING! SHOCK HAZARD!

Do not attempt service of the control system. Contact your spa dealer or a qualified service technician for assistance. Follow all owner's manual power connection instructions. Installation must be performed by a licensed electrician and all grounding connections must be properly installed.



WARRANTY

This warranty begins on the date of purchase and extends to the original purchaser only. Obligation to this warranty is limited to the repair or replacement of defective parts that are returned to Lumi-O | Innovaplas inc or one of its authorized dealers for repair only. If your spa develops a defect within the warranty period and the defect is a warranty related issue, it will be repaired by Lumi-O | Innovaplas inc, its authorized agent or its authorized dealer. If the defect is not warranty related, the spa owner is responsible for all charges related to the repair of the spa. This warranty does not cover any spa that has been subject to misuse, neglect, negligence, accident, civil disturbance, acts of God, or that has been operated in any way contrary to the recommended operating instructions or that has not been installed as specified in Lumi-O | Innovaplas inc's Owner's Manual. This warranty does not cover any spa that has been modified or altered except with parts or options that are authorized by Lumi-O | Innovaplas inc and installed according to recommended installation instructions. It does not cover any damage incurred by moving the spa.

To obtain warranty service, contact your authorized dealer or Lumi-O | Innovaplas inc. You will be asked to provide original proof of purchase documents. Lumi-O | Innovaplas inc's responsibility with respect to warranty is limited to repairing or exchanging defective part(s) and Lumi-O | Innovaplas inc reserves the right to use refurbished parts, at its discretion. Lumi-O | Innovaplas inc neither assumes or authorizes anyone else to assume any other obligation under the terms of this warranty. All final decisions with respect to legitimacy of warranty will be made solely by Lumi-O | Innovaplas inc and Lumi-O | Innovaplas inc assumes no liability with respect to loss of use of a spa during warranty repair.

Lumi-O | Innovaplas inc reserves the right to change or improve the design of any spa without obligation to modify any spa previously manufactured. Lumi-O | Innovaplas inc does not assume any liability or obligation with respect to labor warranty if the authorized dealer ceases to do business.

- **Shell/Surface : Five (5) year warranty**

The structural integrity of the spa (its ability to hold water) is warranted to be free of defects for a prorated** period of five (5) years. The costs of removing, reinstalling and any shipping charges related to the structural repair of a spa are the responsibility of the spa owner. The manufacturer reserves the right to make repairs to the shell/surface. This warranty does not cover superficial damages, minor surface imperfections or discoloration.

** Pro-rata : Suggested retail price, divided by 60 months, multiplied by months of use, plus shipping and handling = replacement cost.

- **Parts : One (1) year warranty**

The heater, pump, spa pack, top side panel and plumbing (excluding sealing gaskets) are warranted to be free of leaks and/or defects for a period of one (1) year.

- **Labor : One (1) year limited warranty**

Labor charges related to repair or replacement of defective components, as listed in the Parts section of this warranty, will be free of charge for a period of one (1) year provided that defective components are returned to Lumi-O | Innovaplas inc or one of its authorized dealers for repair. The spa owner may be subject to an authorized dealer trip charge which is not covered by this warranty. Any other terms and conditions related to labor warranty are an agreement between the original purchaser and the authorized dealer. The original purchaser should consult their authorized dealer for individual terms, conditions and procedures with respect to labor warranty. Lumi-O | Innovaplas inc does not assume any liability or obligation with respect to labor warranty should an authorized dealer cease to do business.

- **Incidentals**

The ozone generator, UV system, waterfall assembly, rotational jets, GFCI, pump seal and heater seal are warranted to be free of defects for a period of ninety (90) days for parts only. All alterable accessories (spa cover, filter cartridges, cover straps, vinyl cover, cover lifters, waterfall housings, main light lens covers, standard light bulbs and LED lights, fuses, drain valve, jets inserts) are warranted to be free of defects at time of delivery.

- **Disclaimers**

The owner must ensure that access to the spa is available for any repair/inspection under warranty. Components that become defective due to corrosion or scale formation as a result of improper water balance and/or spa maintenance are disclaimed, in their entirety, under this warranty. Lumi-O | Innovaplas inc or its agents assume no liability or responsibility for incidental, consequential or other damage including, but not limited to, removal of a deck or other custom fixture(s), transportation or shipping charges, telephone charges, rental of a like product during the time warranty service is being performed, travel, loss or damage to personal property or person, and loss of revenue, use, time or convenience resulting from the loss of use of the spa covered by this warranty. Some states/provinces do not allow the exclusion or limitation of incidental or consequential damages. The above limitations and exclusions may not apply to you. The jurisdiction and venue for any litigation arising with respect to the transaction evidenced by this warranty shall be the Court in and for Saint-Jérôme, Quebec, Canada and buyer hereby agrees to such jurisdiction and venue.

During the winter months, it is the spa owner's responsibility to ensure that the spa's plumbing and shell do not freeze. This warranty does not cover damages caused by frost.