

Highway-Rail Crossing **HANDBOOK**

Third Edition



U.S. Department of Transportation
Federal Railroad Administration



U.S. Department of Transportation
Federal Highway Administration

CMFGA
360-634-1321
120 7th St. NW
10th Floor
Washington, DC 20590

FOREWORD

The Highway-Rail Crossing Handbook, 3rd Edition (*Handbook*) has been prepared to disseminate current practices and requirements for developing engineering treatments for highway-rail grade crossings (referred to herein as “crossings”). The *Handbook* is intended to provide practitioners of all levels of knowledge and experience with critical background information and “noteworthy practices” consistent with the 2009 *Manual on Uniform Traffic Control Devices for Streets and Highways* (MUTCD) and more recent guidance developed by recognized subject matter experts. This edition constitutes a substantial update to and revision of the 2007 *Handbook* and efforts have been made to reorganize the contents. This edition includes “hotlinks” to facilitate navigation and access external information available on the web.

Notice

This document is disseminated under the sponsorship of the U.S. Department of Transportation in the interest of information exchange. The U.S. Government assumes no liability for the use of the information contained in this document. This document does not constitute a standard, specification, or regulation and the contents of this document do not necessarily reflect official policy of the U.S. Department of Transportation.

This document contains images that are shown for illustration purposes only. For specific requirements, please refer to the 2009 edition of the *Manual on Uniform Traffic Control Devices for Streets and Highways*.

The U.S. Government does not endorse products or manufacturers. Trademarks or manufacturers’ names appear in this report only because they are considered essential to the objective of the document.

Quality Assurance Statement

The Federal Highway Administration (FHWA) and Federal Railroad Administration (FRA) provide high-quality information to serve Government, industry, and the public in a manner that promotes public understanding. Standards and policies are used to ensure and maximize the quality, objectivity, utility, and integrity of its information. The FHWA and FRA periodically review quality issues and adjusts their programs and processes to ensure continuous quality improvement.

TECHNICAL REPORT DOCUMENTATION PAGE (FORM DOT F 1700.7)

Technical Report Documentation Page

1. Report No. FHWA-SA-18-040/FRA-RRS-18-001	2. Government Accession No.	3. Recipient's Catalog No.	
4. Title and Subtitle <i>Highway-Rail Crossing Handbook, 3rd Edition</i>		5. Report Date July 2019	
		6. Performing Organization Code	
7. Author(s) Brent D. Ogden, Kimley-Horn and Associates, Inc. Chelsey Cooper, Kimley-Horn and Associates, Inc.		8. Performing Organization Report No.	
9. Performing Organization Name and Address Institute of Transportation Engineers 1617 Eye Street NW, Suite 600 Washington, DC 20006		10. Work Unit No. (TRAIS)	
		11. Contract or Grant No. TFH61-13-D-00026	
12. Sponsoring Agency Name and Address Office of Safety Design Federal Highway Administration 1200 New Jersey Avenue, SE Washington, DC 20590 Federal Railroad Administration 1200 New Jersey Avenue, SE Washington, DC 20590		13. Type of Report and Period Covered	
		14. Sponsoring Agency Code	
15. Supplementary Notes: FHWA Contracting Officer's Task Order Manager: Kelly Morton; FRA Task Order Manager: Debra Chappell; ITE Project Manager: Lisa Fontana Tierney; ITE Technical Publications Manager: Deborah Rouse.			
16. Abstract The purpose of the <i>Highway-Rail Crossing Handbook, 3rd Edition</i> is an information resource developed to provide a unified reference document on prevalent and best practices as well as adopted standards relative to highway-rail grade crossings. The handbook provides general information on highway-rail crossings; characteristics of the crossing environment and users; and physical and operational changes that can be made at crossings to enhance the safety and operation of both highway and rail traffic over such intersections. The guidelines identified and potential alternative improvements presented in this handbook reflect current best practices nationwide. This handbook supersedes the <i>Railroad-Highway Grade Crossing Handbook—Revised Second Edition</i> published in August 2007. This version includes a compendium of materials that were included in the previous one, supplemented with new information and applicable regulations in force that were available at the time of the update.			
17. Key Words Grade Crossing, Railroad, Traffic Control, Crossing Safety		18. Distribution Statement	
19. Security Classif. (of this report) Unclassified	20. Security Classif. (of this page) Unclassified	21. No. of Pages 250	22. Price

SI* (MODERN METRIC) CONVERSION FACTORS

APPROXIMATE CONVERSIONS TO SI UNITS				
SYMBOL	WHEN YOU KNOW	MULTIPLY BY	TO FIND	SYMBOL
LENGTH				
in	inches	25.4	millimeters	mm
ft	feet	0.305	meters	m
yd	yards	0.914	meters	m
mi	miles	1.61	kilometers	km
AREA				
in ²	square inches	645.2	square millimeters	mm ²
ft ²	square feet	0.093	square meters	m ²
yd ²	square yard	0.836	square meters	m ²
ac	acres	0.405	hectares	ha
mi ²	square miles	2.59	square kilometers	km ²
VOLUME				
fl oz	fluid ounces	29.57	milliliters	mL
gal	gallons	3.785	liters	L
ft ³	cubic feet	0.028	cubic meters	m ³
yd ³	cubic yards	0.765	cubic meters	m ³
NOTE: volumes greater than 1000 L shall be shown in m ³				
MASS				
oz	ounces	28.35	grams	g
lb	pounds	0.454	kilograms	kg
T	short tons (2000 lb)	0.907	megagrams (or "metric ton")	Mg (or "t")
TEMPERATURE (exact degrees)				
°F	Fahrenheit	5 (F-32)/9 or (F-32)/1.8	Celsius	°C
ILLUMINATION				
fc	foot-candles	10.76	lux	lx
fl	foot-Lamberts	3.426	candela/m ²	cd/m ²
FORCE and PRESSURE or STRESS				
lbf	poundforce	4.45	newtons	N
lbf/in ²	poundforce per square inch	6.89	kilopascals	kPa

APPROXIMATE CONVERSIONS FROM SI UNITS				
SYMBOL	WHEN YOU KNOW	MULTIPLY BY	TO FIND	SYMBOL
LENGTH				
mm	millimeters	0.039	inches	in
m	meters	3.28	feet	ft
m	meters	1.09	yards	yd
km	kilometers	0.621	miles	mi
AREA				
mm ²	square millimeters	0.0016	square inches	in ²
m ²	square meters	10.764	square feet	ft ²
m ²	square meters	1.195	square yards	yd ²
ha	hectares	2.47	acres	ac
km ²	square kilometers	0.386	square miles	mi ²
VOLUME				
mL	milliliters	0.034	fluid ounces	fl oz
L	liters	0.264	gallons	gal
m ³	cubic meters	35.314	cubic feet	ft ³
m ³	cubic meters	1.307	cubic yards	yd ³
MASS				
g	grams	0.035	ounces	oz
kg	kilograms	2.202	pounds	lb
Mg (or "t")	megagrams (or "metric ton")	1.103	short tons (2000 lb)	T
TEMPERATURE (exact degrees)				
°C	Celsius	1.8C+32	Fahrenheit	°F
ILLUMINATION				
lx	lux	0.0929	foot-candles	fc
cd/m ²	candela/m ²	0.2919	foot-Lamberts	fl
FORCE and PRESSURE or STRESS				
N	newtons	0.225	poundforce	lbf
kPa	kilopascals	0.145	poundforce per square inch	lbf/in ²

TABLE OF CONTENTS

CHAPTER 1. INTRODUCTION	1
GLOSSARY	2
CHAPTER 2. ENGINEERED TREATMENTS	11
EXISTING LAWS, RULES, REGULATIONS, AND POLICIES	11
CLOSURE OR SEPARATION	12
CROSSING CONSOLIDATION AND SAFETY PROGRAMS	16
State Program Example—NCDOT	16
Local Program Example—San Gabriel Valley Council of Governments (SGVCOG)	18
Railroad Program Example—BNSF Railway Company (BNSF)	18
INACTIVE OR ABANDONED CROSSINGS	18
REMOVAL OF GRADE SEPARATION STRUCTURES	19
State Level Guidance—Pennsylvania	20
RELOCATION	21
SITE IMPROVEMENTS	21
Crossing Geometry	22
Removing Obstructions and Sight Distance	27
Illumination	31
Safety Barriers and Crossing Surfaces	33
NEW CROSSINGS	34
PASSIVE CROSSING TREATMENTS	34
Signs	34
Pavement Markings	47
Exclusion Zone (Keep Clear) Treatments	48
Edge Lines	48
Arrow Markings	50
Dynamic Envelope	50
ACTIVE TREATMENTS	51
Overview	51
Train Detection and Device Activation	51
Constant Warning Time Track Circuit	53
Warning Time Considerations	53
FLASHING-LIGHT SIGNALS	55
Cantilevered Flashing-Light Signals	57
Supplemental Flashing-Light Signals	58
AUDIBLE WARNING	62
Wayside Horn	62
AUTOMATIC GATES	64
Four-Quadrant Gates	70
Barrier Gate	72
USE OF CHANNELIZATION WITH GATES	72
Barrier Wall Systems	73

Wide Raised Medians	73
Non-Mountable (Non-Traversable) Curb Islands	73
Mountable Raised Curb Systems (Traffic Separators)	75
PREEMPTION OF TRAFFIC SIGNALS	76
Excerpts from ITE Recommended Practice on Preemption of Traffic Signals Near Railroad Crossings	78
Pre-Signal and Queue Cutter Design Considerations	86
Management of Queueing at Frontage Roads	93
Adjacent Railroad Crossings	95
Active Advance Warning Signs	96
TRANSIT AND ON-STREET RAIL	96
Control of Motor Vehicle Turning Treatments	98
LRT Bar Signals	101
Pedestrian and Bicycle Signals at LRT Crossings	102
PEDESTRIANS, BICYCLES, AND ACCESSIBILITY	102
Channelization	103
Accessibility Standards	104
MUTCD Provisions	104
Current Practices	104
Recommended Practices for Stop Lines and Detectable Warnings	105
ILLUSTRATIVE EXAMPLES OF PEDESTRIAN TREATMENTS	108
Pathway Crossing Signing and Markings for Bicyclists and Skaters	108
Dynamic Envelope Markings	109
Pedestrian Barriers	110
Z-crossing Channelization	111
Swing Gates	113
Flashing-Light Signals	114
Pedestrian Automatic Gates	116
Crossing Gate Skirt	116
CHAPTER 3. TREATMENT SELECTION GUIDANCE	119
TECHNICAL WORKING GROUP GUIDANCE	119
PEDESTRIAN TREATMENTS	129
DIAGNOSTIC STUDY METHOD	130
ECONOMIC BENEFIT-COST ANALYSIS	130
RESOURCE ALLOCATION PROCEDURE	131
FRA GRADEDEC SOFTWARE	136
MUTCD Interpretations, Experimentation, Changes, and Interim Approvals	136

CHAPTER 4. PROJECT IMPLEMENTATION	139
PROGRAM DEVELOPMENT	139
FUNDING	140
Federal Sources	140
State Funding.....	142
Local Agency Funding	143
Railroad Funding.....	143
AGREEMENTS	143
DESIGN AND CONSTRUCTION	144
TRAFFIC CONTROL DURING CONSTRUCTION	144
Traffic Control Zones	145
Traffic Control Devices	145
Typical Applications.....	146
CHAPTER 5. MAINTENANCE, MANAGEMENT, AND OPERATIONS	149
RESPONSIBILITIES	149
TRAFFIC CONTROL DEVICES	149
INTERCONNECTED SYSTEMS	150
ROADSIDE CLEAR ZONE	150
ROADSIDE APPROACHES	151
ROUTINE MAINTENANCE	151
BLOCKED CROSSINGS	152
Solutions to Blocked Crossings.....	153
DOT CROSSING INVENTORY	154
CHAPTER 6. SPECIAL TOPICS	155
PRIVATE CROSSINGS	155
SHORT LINE RAILROADS	156
LIGHT RAIL AND BUSWAYS	157
HIGH SPEED RAIL	160
TRUCKS AND BUSES	163
Trucks with Hazardous Material Cargo.....	163
Buses	163
Long and Heavily Laden Trucks	164
BICYCLES AND MOTORCYCLES	164
ITS	165
ITS National Architecture and User Service 30	166
Standard 1570.....	168

QUIET ZONES.....	168
Overview	168
Requirement to Sound the Locomotive Horn.....	169
Creation of Quiet Zones	170
Establishment of New Quiet Zones.....	170
Length of Quiet Zones.....	171
Supplemental and Alternative Safety Measures.....	171
Automated Wayside Horn	172
Special Circumstances.....	172
EDUCATION AND ENFORCEMENT.....	172
Education.....	172
Enforcement	173
 APPENDICES.....	 175
 REFERENCES.....	 243

LIST OF FIGURES

Figure 1. Highway-Rail Crossing Cross Section.....	23
Figure 2. Fitting Three Vertical Curves to an Approach to a Railroad Crossing Profile	25
Figure 3. Low Ground Clearance Warning Signs.....	25
Figure 4. Treatment for Low Ground Clearance	26
Figure 5. Approach Regions with Passive Traffic Control Devices.....	28
Figure 6. Pole and Luminaire Locations Where a Railroad ROW Crosses a Public Roadway	32
Figure 7. Regulatory Signs and Plaques for Crossings	35
Figure 8. Warning Signs and Plaques for Crossings.....	36
Figure 9. Crossing Sign (Crossbuck).....	41
Figure 10. Typical Sign System with STOP or YIELD.....	41
Figure 11. Highway-Rail Crossing (Crossbuck) Sign and STOP or YIELD Sign on Same Post	42
Figure 12. Highway-Rail Crossing (Crossbuck) Sign and STOP Sign on Separate Posts	43
Figure 13. Example of Emergency Notification Sign (ENS).....	45
Figure 14. Placement of Advance Warning Signs with Parallel Roadway	45
Figure 15. Substandard Clear Storage Distance	46
Figure 16. Example of Placement of Warning Signs and Pavement Markings at Highway-Rail Crossings	47
Figure 17. Use of Diagonal Exclusion Zone Striping Shown at Pre-Signal Location	49
Figure 18. Illustration of Use of Tubular Markers (Metro North Harlem Subdivision, Green Lane Crossing, Bedford Hills, NY ID 529898H).....	49
Figure 19. Example of Dynamic Envelopment Pavement Markings at Grade Crossings	50
Figure 20. DC Track Circuit.....	52
Figure 21. Illustrative Example Showing Cantilever with Flashing-Light Devices	55
Figure 22. Typical Alignment Pattern for Flashing-Light Signals with 30-15 Degree Roundel, Two-Lane, Two-Way Roadway	57
Figure 23. Use of Multiple Flashing-Light Signals for Adequate Visibility Horizontal Curve to the Left	59
Figure 24. Use of Multiple Flashing-Light Signals for Adequate Visibility Horizontal Curve to the Right.....	60
Figure 25. Use of Sidelights for Frontage Roads	61
Figure 26. Automated Wayside Horn.....	63
Figure 27. Typical Location of Signal Devices	65
Figure 28. Typical Crossing Gate Placement at 2-Lane Orthogonal Crossing	67
Figure 29. Typical Crossing Gate Placement at Obtuse Angled Crossing.....	67
Figure 30. Typical Crossing Gate Placement at Acute Angled Crossing.....	68
Figure 31. Alternate Crossing Gate Placement at Acute Angled Crossing (Shown with Exit Gates).....	68
Figure 32. Typical Crossing Gate and Cantilever Placement at Multi-Lane Roadway with Medians and Median Gates—Cantilever Upstream from Gates.....	69
Figure 33. Typical Crossing Gate and Cantilever Placement at Multi-Lane Roadway with Medians and Median Gates—Cantilever Downstream from Gates	69
Figure 34. Example of Location Plan for Flashing-Light Signals and Four-Quadrant Gates.....	71

Figure 35. Example of a Resistance Barrier	72
Figure 36. Example of Combination of Mountable and Non-Mountable Curbs from Illinois Department of Transportation	74
Figure 37. Example of a Traffic Separator.....	75
Figure 38. Clear Storage and Minimum Track Clearance Distance	77
Figure 39. Illustrative Example Showing Use of Relocated Stop Line (Dallas Rapid Transit Red Line S. Hampton Rd Crossing at Wright Street, Dallas, TX)	87
Figure 40. Illustrative Example Showing Displaced Stop Line (PCJX S. Mary Avenue Crossing at W. Evelyn Avenue, Sunnyvale, CA, USDOT 755037b).....	88
Figure 41. Illustrative Example Showing Downstream Mounted Pre-Signal (SCAX Sierra Avenue Crossing at Orange Way, Fontana, CA, USDOT 026145L)	89
Figure 42. Illustrative Example of a Cantilever-Mounted Pre-Signal (CSX 120th Avenue Crossing at E. Lakewood Boulevard in Holland, MI, USDOT 234648C).....	90
Figure 43. Illustrative Example of Queue Cutter (SCAX Balboa Boulevard Crossing at Roscoe Boulevard in Los Angeles, CA, USDOT 745989G)	91
Figure 44. Queue Prevention Strategies.....	92
Figure 45. Illustrative Example of Stop Sign Placement	94
Figure 46. No Turns Internally Illuminated Signs.....	99
Figure 47. LRT Signals	101
Figure 48. Example of Signing and Markings for a Pathway Crossing.....	108
Figure 49. Illustrative Example of an ADA Dynamic Envelope Delineation (Sacramento Regional Transit, K Street Pedestrian Mall, Sacramento, CA)	109
Figure 50. Illustrative Example of Dynamic Envelope Delineation through a Pedestrian Crosswalk (Portland TriMet, Morrison Street, Portland, Oregon).....	109
Figure 51. Diagram Depicting Use of Pedestrian Barriers.....	110
Figure 52. Illustrative Example of a Pedestrian Barrier Application (BNSF Cotton Crossing, Peoria, AZ USDOT 025405Y).....	110
Figure 53. Illustrative Example of a Z-Crossing Diagrammatic Plan for an In-Situ Application in Portland, Oregon	112
Figure 54. Illustrative Example of a Z-Crossing (Portland TriMet, Burnside Avenue, Portland, OR).....	112
Figure 55. Diagrammatic Plan of a Swing Gate	113
Figure 56. Illustrative Example of Pedestrian Automatic Gate with Swing Gate	114
Figure 57. Flashing-Light Signal Placement Options	115
Figure 58. Examples of Placement of Pedestrian Gates.....	117
Figure 59. Diagrammatic Example of Pedestrian Gate with Skirt.....	118
Figure 60. Illustrative Example of Pedestrian Gate with Skirt (DART Blue Line Lynn Haven Avenue Crossing, Dallas, TX)	118
Figure 61. Resource Allocation Procedure Field Verification Worksheet.....	135
Figure 62. Work in the Vicinity of a Crossing (TA-46).....	147
Figure 63. Crossing Work Activities, Closure of Side Road Crossing	147
Figure 64. Train Speed Warning Sign.....	162
Figure 65. Design for Degree of Trail-Rail Crossing	165
Figure 66. Highway Rail Intersection Interface Overview	166

LIST OF TABLES

Table 1. Federal Requirements for High-Speed Rail Crossings.....	11
Table 2. Sight Distance Zones.....	28
Table 3. Clearing Sight Distance Criteria by Mode.....	30
Table 4. Current MUTCD Signs	37
Table 5. Comparison of Queue Management Devices and Techniques.....	85
Table 6. Use of Active Internally Illuminated Signs for Parallel Traffic Turning Across LRT Tracks....	100
Table 7. LRT Grade Separation.....	123
Table 8. Collision Prediction and Resource Allocation Procedure Normalizing Constants	134
Table 9. Recommended Advance Warning Sign Minimum Spacing.....	146
Table 10. Possible Solutions to Observed Problems at LRT Crossings.....	157
Table 11. Potential Tier Structure for Passenger Systems at Highway-Rail Crossings	161

APPENDICES

A. APPENDIX—BACKGROUND	175
INTRODUCTION	175
KEY STATISTICS.....	178
Safety and Operations at Highway-Rail Grade Crossings	178
Crossing Improvement Funding Programs.....	182
RESPONSIBILITIES	186
Fundamental Issues of Highway-Rail Crossings.....	186
Government Agency Responsibility and Involvement.....	187
Railroad Responsibility and Involvement	191
B. APPENDIX—COMPONENTS OF A HIGHWAY-RAIL GRADE CROSSING	193
HIGHWAY COMPONENTS.....	193
Driver.....	193
Vehicle	196
Pedestrians	200
Roadway	201
Traffic Control Devices	203
RAILROAD COMPONENTS.....	204
Train.....	204
Track.....	206
C. APPENDIX—ASSESSMENT OF CROSSING SAFETY AND OPERATION.....	209
COLLECTION AND MAINTENANCE OF DATA.....	209
USDOT Grade Crossing Inventory	209
Highway-Rail Grade Crossing Collision Data	210
HAZARD INDICES AND ACCIDENT PREDICTION FORMULAE.....	212
Hazard Index	213
Crash Prediction Model.....	213
USDOT Accident Prediction Model.....	214
ENGINEERING STUDY.....	215
Diagnostic Team Study Method	215
Corridor Approach.....	229
D. APPENDIX—DIAGNOSTIC TEAM CROSSING EVALUATION REPORTING EXAMPLES FROM STATES.....	233
E. APPENDIX—PREEMPTION CALCULATION PROCEDURES, EXAMPLE FROM STATE OF TEXAS.....	237

APPENDICES: LIST OF FIGURES

Figure A-1. Railroad Crossing Deaths, Injuries, and Incidents from 2008–2017	178
Figure B-1. Reflectorization Example—Standards Applicable to Boxcars	205
Figure C-1. Rail Equipment Accident/Incident Report Form	211
Figure C-2. Sample Questionnaire for Diagnostic Team Evaluation.....	218
Figure C-3. Study Positions for Diagnostic Team	220
Figure C-4. Sight Distance for Moving Vehicle	224
Figure C-5. Sight Distance for Stopped Vehicle.....	227
Figure C-6. Pedestrian Sight Distance Triangle (Double Track Crossing).....	228
Figure D-1. State of Texas Department of Transportation Diagnostic Review Form	235
Figure E-1. Texas DOT—Guide for Determining Time Requirements for Traffic Signal Preemption at Highway-Rail Grade Crossings	241

APPENDICES: LIST OF TABLES

Table A-1. Class 1 Railroad Line Miles and Track Miles	176
Table A-2. Public At-Grade Crossings by Functional Classifications, 2017	177
Table A-3. Public At-Grade Crossing by Highway System, 2017	177
Table A-4. Fatalities at Public Crossings, 1920–2017	180
Table A-5. Collisions, Fatalities, and Injuries at Public Crossings, 1975–2017	181
Table A-6. Collisions at Public Crossings Involving Motor Vehicles by Type of Train, 2004.....	182
Table B-1. Public Crossings by Warning Device, 2017	194
Table B-2. Motor Vehicle Collisions and Casualties at Public Crossings by Vehicle Type, 2017	197
Table B-3. U.S. Customary Lengths for Design Vehicles	198
Table B-4. Highway-Rail Grade Crossing Collision Fatalities versus Trespasser Fatalities, 2008–2017	201
Table B-5. Maximum Train Speeds by Class of Track.....	207
Table B-6. Public At-Grade Crossings by Type of Track, 2017	208
Table C-1. Sight Distances for Combinations of Highway Vehicle and Train Speeds.....	221
Table C-2. Clearing Sight Distances (in Feet)	229

LIST OF ABBREVIATIONS AND SYMBOLS

AADT = annual average daily traffic

AAR = Association of American Railroads

AASHTO = American Association of State Highway and Transportation Officials

AAWS = active advance warning sign

ADA = Americans with Disabilities Act

AREMA = American Railway Engineering and Maintenance-of-Way Association

ASLRRA = American Short Line and Regional Railroad Association

BRT = Bus Rapid Transit

C&M = construction and maintenance

CFR = Code of Federal Regulations

Crossing(s) = At-Grade Highway-Rail Crossing(s)

CSD = Clear Storage Distance

DOT = Department of Transportation

DSRC = Dedicated Short-Range Communications

FAPG = Federal-Aid Policy Guide

FARS = Fatal Accident Reporting System

FAST Act = Fixing America's Surface Transportation Act

FHWA = Federal Highway Administration

FMCSA = Federal Motor Carrier Safety Administration

FRA = Federal Railroad Administration

FTA = Federal Transit Administration

GPS = Global Positioning System

HSIP = Highway Safety Improvement Program

ICC = Interstate Commerce Commission

IEEE = Institute of Electrical and Electronics Engineers

ISTEA = Intermodal Surface Transportation Efficiency Act

ITE = Institute of Transportation Engineers
ITS = Intelligent Transportation Systems
LED = light emitting diode
LRT = light-rail transit
LRV = light-rail vehicles
MAP-21 = Moving Ahead for Progress in the 21st Century Act
MCSAP = Motor Carrier Safety Assistance Program
MPH or mph = miles per hour
MTB = Materials Transportation Bureau
MTCDD = Minimum Track Clearance Distance
MUTCD = *Manual on Uniform Traffic Control Devices*
NCDOT = North Carolina Department of Transportation
NCHRP = National Cooperative Highway Research Program
NCUTCD = National Committee on Uniform Traffic Control Devices
NHS = National Highway System
NHTSA = National Highway Traffic Safety Administration
NSRT = Nationwide Significant Risk Threshold
NTD = National Transit Database
NTSB = National Transportation Safety Board
O&M = Operations and Maintenance
OLI = Operation Lifesaver Incorporated
PHMSA = Pipeline and Hazardous Materials Safety Administration
PL = Public Law
PROWAG = [Draft] Proposed Right-of-Way Accessibility Guidelines
QZRI = Quiet Zone Risk Index
ROW = right-of-way
SAFETEA-LU = Safe, Accountable, Flexible, Efficient Transportation Equity Act:
A Legacy for Users

SHSP= Strategic Highway Safety Plan
SMIS = Safety Management Information System
STAA= Surface Transportation Assistance Act
STB = Surface Transportation Board
STP = Surface Transportation Program
TEA-21 = Transportation Equity Act for the 21st Century
TCRP = Transit Cooperative Research Program
TMS = Traffic Management System
TRB = Transportation Research Board
TTC = Temporary Traffic Control
TTCI = Transportation Technology Center, Inc.
TWG = Technical Working Group
U.S.C. = United States Code
USDOT = United States Department of Transportation
UVC = Uniform Vehicle Code
WBAPS = Web Based Accident Prediction System

CHAPTER 1. INTRODUCTION

The *Highway-Rail Crossing Handbook—Third Edition (Handbook)* is a compendium of recommended safety engineering treatments for at-grade highway-rail crossings (crossings) which summarizes current noteworthy or best practices and provides a range of options for consideration. It is an information resource to provide a unified reference document on prevalent and best practices as well as adopted standards relative to highway-rail grade crossings. The purpose of the *Handbook* is not to establish standards, but to provide guidance about how existing standards and recommended practices may be applied in developing safe and effective treatments for crossings. For this purpose, the *Railroad-Highway Grade Crossing Handbook, Revised Second Edition*, August 2007, has been updated and re-organized to showcase noteworthy practices regarding device selection, while retaining relevant background information.

The *Handbook* is intended for use by practitioners of all levels of knowledge and experience involved with the design and management of highway-rail crossings. This includes: local highway agencies/authorities, municipal planners, traffic engineers, transportation planners, safety analysts, Metropolitan Planning Organizations (MPOs), State Departments of Transportation (DOT), and allied regulatory commissions (including people responsible for program development, safety management, and data management sections of the applicable State agency), railroad public project managers, public safety coordinators, railroad maintenance officials, and signal designers and maintainers, law enforcement agencies and emergency responders. Additionally, non-governmental advocates and organizations such as Operation Lifesaver, Inc.'s Authorized Volunteers, school transportation managers, commercial motor carriers, property developers and others may also benefit from sections of the *Handbook*.

This edition of the *Handbook* is intended to be consistent with the 2009 edition of the *Manual on Uniform Traffic Control Devices (MUTCD)*.⁽¹⁾ Guidance in general use by practitioners within the industry that is not prescribed within the MUTCD has been characterized as “current practice.” If there are differences between this *Handbook* and the current edition of the MUTCD, then the MUTCD, Interim Approvals, and Interpretations should be followed.

The *Handbook* is consistent with the 2013 version of the *Traffic Control Devices Handbook* prepared by the Institute of Transportation Engineers (ITE) and also incorporates portions of the *Proposed Recommended Practice for Preemption of Traffic Signals Near Railroad Crossings*, which was updated in 2019 by ITE.^(2,3)

Additionally, the *Handbook* provides an update to and supersedes the *Guidance on Traffic Control Devices at Highway-Rail Grade Crossings* originally developed in 2002 by the United States Department of Transportation (USDOT) Federal Highway Administration (FHWA) Highway/Rail Grade Crossing Technical Working Group (TWG). This update was accomplished by a task force of knowledgeable practitioners conversant with current best practices and as such the guidance provided in this *Handbook* supersedes the prior version.

Note: This document summarizes current practices but does not set standards; practitioners are advised to check current local standards and requirements (refer to Disclaimer and Quality Assurance Statement). Users of the data provided within this document should anticipate possible variations from current information within the FRA databases, which are updated monthly.

GLOSSARY

Abandonment. The relinquishment of interest (public or private) in a ROW or activity thereon with no intention to reclaim or use again for the original purposes.

Active Crossing. A grade crossing which includes an Active Grade Crossing Warning System as described below.

Active Grade Crossing Warning System. The flashing-light signals, with or without warning gates, together with the necessary control equipment used to inform road users of the approach or presence of rail traffic at grade crossings.

Advance Preemption. The notification of approaching rail traffic that is forwarded to the highway traffic signal controller unit or assembly by the railroad equipment in advance of the activation of crossing warning devices.

Advance Preemption Time. The period of time that is the difference between the required maximum highway traffic signal preemption time and the activation of the railroad warning devices.

Alignment, Exclusive (“exclusive alignment”). The LRT track(s) or a busway alignment that is grade-separated or protected by a fence or traffic barrier. Motor vehicles, pedestrians, and bicycles are prohibited within the traveled way. Subways and aerial structures are included with this group.

Alignment, Mixed-Use (“mixed-use alignment”). An alignment where the LRT vehicles or buses operate in mixed traffic with all types of road users. This includes streets, transit malls, and pedestrian malls where the traveled way is shared. In a mixed-use alignment, the LRT vehicles or buses do not have right-of-way over other roadway users at crossings and intersections.

Alignment, Semi-Exclusive (“semi-exclusive alignment”). The LRT track(s) or a busway alignment that is in a separate traveled way or along a street or railroad ROW where motor vehicles, pedestrians, and bicycles have limited access and cross at designated locations only. In a semi-exclusive alignment, the LRT vehicles or buses usually have ROW over other roadway users at crossings.

Americans with Disabilities Act (ADA) of 1990. A civil rights law that prohibits discrimination based on disability. Refers to the ADA of 1990 (PL 101-336) and the ADA Amendments Act of 2008 (PL 110-325).

Anchors. Rail-fastening devices used to resist the longitudinal movement of rail due to train operations and maintain proper expansion allowance for temperature changes at joint gaps.

Annual Average Daily Traffic (AADT). The total volume of traffic passing a point or segment of a highway facility in both directions for one year divided by the number of days in the year. Normally, periodic daily traffic volumes are adjusted for hours of the day counted, days of the week, and seasons of the year to arrive at average annual daily traffic.

Apportionment. An administrative distribution of funds based on a prescribed formula provided in law by a governmental unit to another governmental unit for specific purposes and for certain periods.

Appropriation. The act of a legislative body that makes federal-aid highway funding available for obligation and expenditure with specific limitations as to amount, purpose, and duration.

Ballast. Material placed on a track roadbed to hold the track in alignment and elevation. It consists of crushed stone, generally 1 to 2 inches in size, angular, rough-surfaced, clean and free of sand, loam, clay, flat, elongated, soft or disintegrated pieces, and other deleterious substances.

Bar Signals (LRT). An illuminated signal configured in the shape of a bar, normally positioned to appear in a vertical, angled, or horizontal orientation. These are used as aspects to convey a signal indication. Bar signals are typically used on LRT systems. LRT bar signals are white, monochrome bar signals that are separated in space from motor vehicle signals.

Barrier Gate (Barrier Gate Arm, Warning/Barrier Gate, Vehicle Arresting System). An automatic gate of specialized design, which can be used as adjunct to flashing light signals to provide positive closure by blocking approaching traffic at a highway-rail crossing and preventing vehicle penetration.

Benefit-Cost Ratio. The economic value of the project benefits (e.g., reduction in fatalities, injuries, and property damage, reduced delay, reduced fuel and operating costs, reduction in emissions, etc.) divided by the cost of the project.⁽⁴⁾

Blank-Out Sign. A sign that displays a single predetermined indication only when activated. When not activated, the sign legend should not be visible.

Cantilevered Signal Structure (Cantilever). A structure that is rigidly attached to a vertical pole and used to provide overhead support of signal units; the term Cantilever refers to a Cantilevered Signal Structure with one or more flashing-light units attached.

Channelization Device. A traffic separation system made up of a raised longitudinal channelizer with vertical panels or tubular delineators. These devices can serve several purposes such as being placed between opposing highway lanes designated to alert or guide traffic in a particular direction, or as a fencing system used to separate modes (e.g., channelize pedestrians).

Clear Storage Distance. The distance available for vehicle storage measured between six (6) feet from the rail nearest the intersection to the intersection stop line or the normal stopping point on the highway.

Clearing Sight Distance. The distance measured along the track which a road user must be able to see to decide whether it is safe to cross based upon the speed of an approaching train and the acceleration characteristics of the highway vehicle.

Clear Zone. The total roadside border area, starting at the edge of the traveled way, available for safe use by errant vehicles. This area may consist of a shoulder, a recoverable slope, a non-recoverable slope, and/or a clear run-out area.

Constant Warning Time Detection. A means of detecting rail traffic that provides road users with relatively uniform warning times prior to the approach of through trains that neither accelerate nor decelerate after having been detected.

Crossing Angle. The angle 90 degrees or less between the intersection of the centerlines of the railroad tracks and the roadway.

Design Vehicle. The longest vehicle permitted by statute of the road authority (State or other) on that roadway.

Diagnostic Team. A group of knowledgeable representatives of the parties of interest (such as the railroad, road authority, State regulatory agency, where applicable) in a highway-rail crossing or group of crossings who evaluate conditions at the crossing(s) to identify safety issues.

Dynamic Envelope. The clearance required for the train and its cargo overhang due to any combination of loading, lateral motion, or suspension failure.

Dynamic Exit Gate Operating Mode. A mode of operation where the exit gate operation is based on the presence of vehicles within the minimum track clearance distance.

Easement. A right to use or control the property of another for a designated purpose. Examples include:

1. *Drainage easement.* An easement for directing the flow of water.
2. *Planting easement.* An easement for reshaping roadside areas and establishing, maintaining, and controlling plant growth thereon.
3. *Sight line easement.* An easement for maintaining or improving the sight distance.
4. *Slope easement.* An easement for cuts or fills.

Economic Analysis. A determination of the cost-effectiveness of a project by comparing the benefits derived and the costs incurred in a project.

Entrance Gate. An automatic gate that can be lowered across the lanes approaching a grade crossing to block road users from entering the grade crossing.

Exit Gate. A crossing gate that is used on the departing lanes of traffic to block users from entering a highway rail crossing.

Exit Gate Clearance Time. For four-quadrant gate systems, the amount of time provided to delay the descent of the exit gate arm(s) after entrance gate arm(s) begin to descend.

Exit Gate Management System. A system using a detector or detectors with processing logic to identify the presence of vehicles within the minimum track clearance distance and used to control the operation of the exit gates or for train control purposes.

Exit Gate Operating Mode. For four-quadrant gate systems, the mode of control used to govern the operation of the exit gate.

Fail-Safe. A design practice applied to a system or device such that the result of failure either prohibits the system or device from assuming or maintaining an unsafe state or causes the system or device to assume a state known to be safe regardless of actual prevailing conditions.

False Activation. A condition under which crossing warning devices are activated but there is no train approaching the crossing.

Flagger (Flagging). A person who actively controls the flow of vehicular traffic into and/or through a temporary traffic control zone using hand-signaling devices or an Automated Flagger Assistance Device (AFAD). In the railroad context, a railroad flagger is a person who is authorized by the railroad to provide warning of the approach of a train or the presence of roadway workers along the right-of-way, and who may be authorized to control rail traffic through a construction zone along a railroad.

Flashing-Light Signals. A warning device consisting of two red signal indications arranged horizontally that are activated to flash alternately when a train is approaching or present at a highway-rail grade crossing.

Functional Classification. Designation of a transportation system into classes or systems by the nature of the service they provide in serving travel needs.

Grade. The rate of ascent or descent of a roadway, expressed as a percent, or the change in roadway elevation per unit of horizontal length.

Grade Crossing (Crossing). The general area where a highway and a railroad and/or light-rail transit route cross at the same level, within which are included the tracks, highway, and traffic control device for traffic traversing that area. In this *Handbook*, Grade Crossings may be referred to as “Crossings.” In this case, it is implied that the crossing is at grade. (See also LRT Grade Crossing.) When the term “Railroad” is used throughout this document; it is inclusive of LRT; however, when “LRT” is the term specifically used, the text is applicable to LRT only.

Grade Separation. A crossing of two roadways, or a roadway and railroad tracks, at different levels that do not physically meet.

Guardrails. A safety barrier intended to deflect an errant vehicle back to the roadway, and prevent an errant vehicle from striking a roadside obstacle that is more hazardous than the guardrail itself.

Highway (Street or Road). A general term for denoting public way for purposes of travel, including the entire area within the ROW.

Highway-Rail Grade Crossing. A location where a highway, road, or street and the railroad ROW cross at the same level, within which are included the railroad tracks, highway, and traffic control devices for highway traffic traveling over the railroad tracks.

Interconnection (Preemption Interconnection). The electrical connection between the railroad crossing warning system and the highway traffic signal controller assembly for preemption.

Light Rail Transit (LRT). LRT is a mode of metropolitan transportation that employs LRT vehicles (commonly known as light rail vehicles, streetcars, or trolleys) that operate on rails in streets in mixed traffic, and LRT traffic that operates in semi-exclusive rights-of-way, or in exclusive rights-of-way. Grade crossings with LRT can occur at intersections or at midblock locations, including public and private driveways.

Locomotive. A piece of on-track equipment other than hi-rail, specialized maintenance, or other similar equipment: 1) With one or more propelling motors designed for moving other equipment; 2) With one or more propelling motors designed to carry freight or passenger traffic or both; or 3) Without propelling motors but with one or more control stands.

Locomotive Cab or Cab Car. The space in a locomotive unit, diesel or electric multiple-unit (DMU/EMU), or push-pull passenger “cab coach” containing the operating controls and providing shelter and seats for the engine crew.

Locomotive Horn. An air horn, steam whistle, or similar audible warning device mounted on a locomotive or control cab car. The terms “locomotive horn,” “train whistle,” “locomotive whistle,” and “train horn” are used interchangeably in the railroad industry.

LRT Grade Crossing (LRT Crossing). The general area where a highway and an LRT route cross at the same level, within which are included the tracks, highway, and traffic control device for traffic traversing that area. (See also **Grade Crossing**.) When the term “Railroad” is used throughout this document; it is inclusive of LRT; however, when “LRT” is the term specifically used, the text is applicable to LRT only.

Main (Track). A track which is used for through trains operating between stations and terminals as distinguished from a siding which branches from a main line track and is of limited length.

Manual on Uniform Traffic Control Devices (MUTCD). The *Manual on Uniform Traffic Control Devices*, approved by the Federal Highway Administration, is the national standard for all traffic control devices installed on any street, highway, or bicycle trail open to public travel in accordance with 23 U.S.C 109(d) and 402(a). For the purpose of the MUTCD applicability, “open to public travel” includes toll roads and roads within shopping centers, airports, sports arenas, and other similar business and/or recreation facilities that are privately owned but where the public is allowed to travel without access restrictions. Except for gated toll roads, roads within private gated properties where access is restricted at all times are not included in this definition.

Maximum Highway Traffic Signal Preemption Time. The maximum amount of time needed following initiation of the preemption sequence for the highway traffic signals to complete the ROW transfer and queue clearance, including separation time.

Median. The area between two roadways of a divided highway measured from edge of traveled way to edge of traveled way, excluding turn lanes. The median width may be different between intersections, interchanges, and opposite approaches of the same intersection.

Minimum Track Clearance Distance (MTCD). For standard two-quadrant warning devices, the minimum track clearance distance is the length along a highway at one or more railroad or light rail transit tracks, measured from the highway stop line, warning device, or 12 feet perpendicular to the track center line, to 6 feet beyond the track(s) measured perpendicular to the far rail, along the center line or edge line of the highway, as appropriate, to obtain the longer distance. For Four-Quadrant Gate systems, the minimum track clearance distance is the length along a highway at one or more railroad or light rail transit tracks, measured either from the highway stop line or entrance warning device, to the point where the rear of the vehicle would be clear of the exit gate arm. In cases where the exit gate arm is parallel to the track(s) and is not perpendicular to the highway, the distance is measured either along the center line or edge line of the highway, as appropriate, to obtain the longer distance.

Minimum Warning Time (MWT). The least amount of time the active crossing warning system is designed to remain activated prior to the arrival of a train at a highway-rail grade crossing.

Passive Crossing. A crossing where warnings and traffic control is provided by passive devices such as signs and pavement markings where no Active Grade Crossing Warning System is present.

Pathway. A general term denoting a public way for purposes of travel by authorized users outside the traveled way and physically separated from the roadway by an open space or barrier and either within the highway ROW or within an independent alignment. Pathways include shared-use paths but do not include sidewalks along the roadway traveled way.

Pathway Crossing. Where a pathway and railroad or LRT tracks cross at the same level, within which are included the track, pathway, and traffic control devices for pathway traffic traversing that area.

Pavement Markings. Markings set into the surface of, applied upon, or attached to the pavement for regulating, warning, or guiding traffic.

Preemption Clearance Interval. The part of a traffic signal sequence displayed as a result of a preemption request when vehicles are provided the opportunity to clear the railroad or LRT tracks, or a busway prior to the arrival of the train, or bus for which the traffic signal is being preempted.

Preemption. The transfer of normal operation of traffic signals to a special control mode that interrupts the normal sequence of traffic signal phases to accommodate train operation at or adjacent to the traffic signal-controlled intersection.

Pre-signal. Traffic control signal faces that control traffic approaching a grade crossing in conjunction with the traffic control signal faces that control traffic approaching a highway-highway intersection beyond the tracks. Supplemental near-side traffic control signal faces for the highway-highway intersection are not considered pre-signals. Pre-signals are typically used where the clear storage distance is insufficient to store one or more design vehicles.

Priority. Modification of the normal highway traffic signal operation process to assign who has the right-of-way in the intersection to accommodate train operation at or adjacent to a traffic signal controlled intersection.

Private Crossing. A location where a private highway, road, or street, including associated sidewalks or pathways, crosses one or more railroad tracks.

Public Crossing. A highway-rail or pedestrian grade crossing where a roadway or a pathway, under the jurisdiction of and maintained by a public authority, intersects with the railroad tracks at the same level. No approach may be on private property, unless State law or regulation provides otherwise.

Queue Clearance Time. The time required for a stopped design vehicle that is stopped inside the minimum track clearance distance to start up, move through, and clear the entire minimum track clearance distance. If pre-signals are present, this time must be long enough to allow the vehicle to move through the intersection or to clear the tracks if there is sufficient clear storage distance. If a four-quadrant gate system is present, this time must be long enough to permit the exit gate arm to lower after the design vehicle is clear of the minimum track clearance distance.

Queue Cutter Signal. A traffic control signal that is located just upstream from a crossing where traffic has been observed to queue across the crossing due to a downstream condition. Queue cutters are intended to prevent vehicular queueing across tracks at a crossing and are activated either by detection of a traffic queue getting close to the crossing, or by the approach of a train. A queue cutter signal is not operated as a part of a downstream intersection traffic control signal but is an independently controlled traffic control signal with interconnection to the adjacent crossing warning signal system.

Quiet Zone. A segment of a rail line, within which is situated one or a number of consecutive public highway-rail crossings at which locomotive horns are not routinely sounded per 49 CFR Part 222.⁽⁵⁾ (May include private and pedestrian crossings.)

Right-of-Way (ROW). A general term denoting land, property, or interest therein, usually in a strip, acquired for or devoted to transportation purposes. Alternately, “right-of-way” is also a term that confers to a road user or train the priority to proceed in preference to other vehicles or pedestrians, depending upon the rules of the road and traffic control devices in use.

Right-of-Way Transfer Time. The maximum amount of time needed by the traffic signal system to change from its current signal indication to present the track clearance green indication. This includes any railroad or highway traffic signal control equipment time to react to a preemption call and any required traffic control signal green, pedestrian walk and clearance, yellow change, and red clearance intervals for conflicting traffic.

Roadway. The portion of a highway improved, designed, or ordinarily used for vehicular travel and parking lanes, but exclusive of the sidewalk, berm, or shoulder even though such sidewalk, berm, or shoulder is used by persons riding bicycles or other human-power vehicles.

Road User. Vehicle operators, pedestrians including persons with disabilities, or bicyclists within a road or highway.

Separation Time. The portion of highway traffic signal preemption time during which the minimum track clearance distance is clear of vehicular traffic prior to the arrival of the train.

Shoulder. The portion of the roadway adjacent to the traveled way that is primarily intended for accommodation of stopped vehicles for emergency use and for lateral support of base and pavement surface courses.

Sidewalk. That portion of a street between the curb line or the lateral line of a roadway, and the adjacent property line or on easements of private property that is paved or improved and intended for use by pedestrians.

Simultaneous Preemption. Notification of an approaching train is forwarded to the highway traffic signal controller unit or assembly and railroad active crossing warning devices at the same time.

Stopping Sight Distance. The length of highway required to safely stop a vehicle traveling at a given speed.

Swing Gate. A self-closing fence-type gate designed to swing open away from the track area and return to the closed position upon release.

Timed Exit Gate Operating Mode. A mode of operation where the beginning of exit gate descent is based on a predetermined time interval.

Traffic Control Device. A sign, signal, marking, or other device used to regulate, warn, or guide traffic.

Train. One or more locomotives coupled with or without cars that operates on railroad or LRT tracks and to which State law requires that all other traffic must yield the ROW at highway-rail grade crossings.

Traveled Way. The portion of the roadway for the movement of vehicles, exclusive of shoulders.

Volume. The number of vehicles passing a given point during a specified length of time.

Warrants. A threshold condition based upon average or normal conditions that, if found to be satisfied as part of an engineering study, shall result in analysis of other traffic conditions or factors to determine whether a traffic control device or other improvement is justified. Warrants are not a substitute for engineering judgment. The fact that a warrant for a particular traffic control device is met is not conclusive justification for the installation of the device.

Wayside Equipment. The signals, switches, and/or control devices for railroad operations housed within one or more enclosures located along the railroad ROW.

Wayside Horn. A stationary horn located at a highway-rail crossing or pathway crossing, designed to provide, upon the approach of a locomotive or train, audible warning to oncoming motorists of the approach of a train.

CHAPTER 2. ENGINEERED TREATMENTS

This chapter presents engineered treatments applicable to highway-rail and pedestrian crossings. The full range of options from closure, reconfiguration, and grade separation to application of passive treatments and active devices is addressed. The applicability of each option or treatment is presented in terms of those typical conditions that would indicate consideration of such a device or treatment. Specific guidance on device selection is presented in Chapter 3. This chapter also addresses over-arching legal and policy considerations that should be kept in mind.

Note: Traffic control devices defined in the *Manual on Uniform Traffic Control Devices* (MUTCD) terms are referenced along with their respective sign number (in parentheses) throughout this section.

EXISTING LAWS, RULES, REGULATIONS, AND POLICIES

Current FHWA regulations specifically prohibit at-grade intersections on Interstate highways (AASHTO “A Policy on Design Standards—Interstate System,” May 2016).⁽⁶⁾ Federal Railroad Administration (FRA) has established maximum permissible speeds by track class category (refer to Appendix B, Table B-5 for track classes and allowable speeds). Current FRA regulations require that crossings be separated or closed at locations where trains operate at speeds above 125 mph—track Class 8 or 9 (49 CFR 213.347(a)). Additionally, on FRA track Class 7 (111–125 mph), an application must be made to FRA for approval of the type of warning/barrier system to be used at highway-rail grade crossings along the track (49 CFR 213.347(b)). The regulation does not specify the type of system but allows the petitioner to propose a suitable system for FRA review. These requirements are summarized in **Table 1**.

In 1998, FRA issued an Order of Particular Applicability for high-speed rail service on the Northeast Corridor.⁽⁷⁾ In the Order, FRA set a maximum operating speed of 80 mph over any highway-rail crossing where only conventional warning systems are in place and a maximum operating speed of 95 mph where four-quadrant gates and presence detection are provided and tied into the signal system. Crossings are prohibited on the Northeast Corridor if maximum operating speeds exceed 95 mph.

Table 1. Federal Requirements for High-Speed Rail Crossings

—	Active	Warning/Barrier with FRA Approval	Grade Separation or Closure
Interstate highways	Not allowed	Not allowed	Required
High-speed rail	> 79 mph	111–125 mph	> 125 mph

Note: This document summarizes current practices but does not set standards; practitioners are advised to check current local standards and requirements (refer to Disclaimer and Quality Assurance Statement). Users of the data provided within this document should anticipate possible variations from current information within the FRA databases, which are updated monthly.

Special consideration applies to crossings where train speeds are expected to exceed 110 mph. FRA regulations require the use of an approved “barrier system” if train operation is projected at 111–125 mph speeds. As stated in the 2009 *Highway-Rail Grade Crossing Guidelines for High-Speed Passenger Rail* published by the FRA⁽⁸⁾, barrier systems need to meet the following criteria to be effective:

- Operate in concert with the crossing warning system, and the combined system provides critical information about the health and status of the system to the train control system in real time
- Able to stop the heaviest motor vehicle operated on the roadway short of the crossing
- Include the capability to detect any significant obstruction (object) that remains on the crossing after the barriers are in place
- Able to communicate the presence of any significant obstruction to approaching high-speed trains with enough time for the train to reduce speed or stop before reaching the crossing

The interaction between high-speed trains and pedestrians should be carefully considered when identifying appropriate warning systems and treatments to be implemented. The single largest cause of deaths associated with railroad operations is pedestrians trespassing on railroad property. Special consideration should be applied to controlling trespassing attempts.

Private grade crossings on high-speed rail corridors are considered separately. Such crossings may be located along non-public roads within industrial, residential, or agricultural lands. Private crossings generally exist because of an agreement between a railroad and a land owner. Therefore, in most cases those parties determine the appropriate treatment for the crossing. Where private crossings are open to public travel, consideration should be given to providing similar treatment to that which would be provided at a public crossing. In addition, if private crossings exist within a proposed quiet zone, a diagnostics review may be required, and a determination should be made of an appropriate treatment. Additional information can be found in FRA’s regulations at 49 CFR 213.347, including the requirement that crossings be separated or closed at locations where train speeds exceed 125 mph.

CLOSURE OR SEPARATION

The first alternative that should always be considered for a highway-rail crossing is elimination, which can be accomplished by the following:

- Replacing the crossing with a grade separated facility
- Closing the crossing to highway traffic and removing the roadway crossing surface
- Closing the crossing to railroad traffic through the abandonment or relocation of the rail line and removal of the railroad tracks

Closure of a crossing provides the highest level of crossing safety compared to other alternatives, because the point of intersection between highway and railroad is removed. However, the effects of closure on highway and railroad operations may not always be completely beneficial. The

major benefits of crossing closure include reductions in certain types of collisions and decreased delays to highway and rail traffic, as well as lowered maintenance costs.

Decisions about whether a crossing should be eliminated or simply improved depends upon safety, operational, and cost considerations. However, federal regulation (23 CFR 646.214(c)) specifies that “all crossings of railroads and highways at grade shall be eliminated where there is full control of access on the highway (a freeway) regardless of the volume of railroad or highway traffic.”

The following four types of delay can occur on highway traffic by crossings:

- Presence of crossing—This delay occurs regardless of whether a train is approaching or occupying the crossing. Motorists usually slow in advance of crossings so that they can stop safely if a train is approaching. This is a required safe driving practice in conformance with the Uniform Vehicle Code, which states “...*vehicles must stop within 15 to 50 feet from the crossing when a train is in such proximity so as to constitute an immediate hazard.*”⁽⁹⁾ Therefore, the existence of a crossing may cause some delays to motorists who slow to look for a train.
- Traffic control devices—Road users are subject to delay at passive crossings with STOP or YIELD signs as well as at active crossings when traffic control devices are actuated.
- Trains blocking crossings—Trains may stop and block a crossing in response to a train signal indication or during switching operations.
- Special vehicles—Under the Federal Motor Carrier Safety Administration (FMCSA) regulations, all vehicles transporting passengers and trucks carrying many types of hazardous materials must stop prior to crossing tracks at a highway-rail crossing (49 CFR 392.10). If following vehicles do not anticipate such stops and/or fail to maintain safe stopping distance, collisions may result.

Another benefit of crossing closure is the alleviation of maintenance costs of surfaces and traffic control devices. As discussed in Chapter 5, these costs can be quite substantial for both highway agencies and railroads.

Some States have incentive programs intended to encourage crossing closure. Additionally, railroads may participate in a project resulting in a closure either on a case-by-case basis or as part of an initiative (one State’s program is described in the following section). Crossing closures are usually accomplished by closing the highway. The number of crossings needed to carry highway traffic over a railroad in a community is influenced by many characteristics of the community itself. A study of community travel demand should be conducted to determine major origin and destination points and assess what is needed to provide adequate highway capacity then needed to satisfy demand. Thus, optimum routes over railroads can be determined. Traffic over several crossings may be consolidated to a nearby crossing with flashing-lights and gates or over a nearby grade separation. Alternative routes should be within a reasonable travel time and distance from a closed crossing. The alternative routes should have sufficient capacity to accommodate the diverted traffic safely and efficiently. The impact on pedestrian travel should be evaluated as well.

Identifying and eliminating redundant, closely spaced, or unneeded crossings should be a high priority. The decision to close or consolidate crossings requires balancing public safety,

convenience, and access with the needs of the railroad to operate trains safely and efficiently. The crossing closure decision should be based on economics—comparing the cost of retaining the crossing (e.g., maintenance, collisions, and cost to improve the crossing to an acceptable level if it remains, etc.)—against the cost (if any) of providing alternate access and any adverse travel costs incurred by users having to cross at some other location. While this can be a political and sensitive or controversial issue at the local level, the economics of the situation cannot be ignored. This subject is addressed in the FRA’s *Research Results: Crossing Consolidation Guidelines, RR 09-12*.⁽¹⁰⁾

Challenges to obtain successful closures include negative community feedback, funding, and the lack of forceful State laws authorizing closure or the reluctant utilization of State laws that permit closure.

As part of the process of implementing a crossing closure, it is important to consider whether the diversion of highway traffic may be sufficient to change the type or level of traffic control needed at other crossings. The surrounding street system should be examined to assess the effects of diverted traffic. Often, coupling a closure with the installation of improved or upgraded traffic control devices at one or more adjacent crossings can be an effective means of mitigating local political resistance to the closure.

Legislation that authorizes a State agency to close crossings facilitates the implementation of closures. These State agencies should utilize their authority to close crossings whenever possible. A State agency may be able to accomplish closure where local efforts may not have achieved success. Local opposition sometimes can be overcome by emphasizing the benefits resulting from closure, such as improved traffic flow and safety as traffic is redirected to grade separations or crossings with active traffic control devices. Railroads often support closure not only due to safety concerns but also because closure eliminates maintenance costs associated with the crossing. Refer to the following document for State-by-State specifics: “*Compilation of State Laws and Regulations Affecting Highway-Rail Grade Crossings*.”⁽¹¹⁾

Achieving consensus is integral to the closure process. Closure criteria vary by locality but typically include consideration of the following:

- Train and roadway traffic volume
- Speed of trains
- Number of tracks
- Material being carried
- Crossing location
- Visibility
- Distance to traffic signals
- Number of crashes

Locations with more than four crossings per railroad route-mile with fewer than 2,000 vehicles per day and more than two trains per day are prime candidates for closure.

To assist in the identification of crossings that may be closed, the systems approach might be utilized, as discussed in Chapter 3. With this method, several crossings in a community or rail

corridor are improved by the installation of traffic control devices, while other crossings are closed or grade separated. This is accomplished following a study of traffic flows in the area to ensure continuing access across the railroad. Traffic flows are sometimes improved by the installation of more sophisticated traffic control systems at the remaining crossings.

Another important matter to consider regarding crossing closure is access over the railroad by emergency vehicles. Crossings frequently utilized by emergency vehicles should be candidates for grade separations or the installation of active traffic control devices. Specific criteria to identify crossings that should be closed are difficult to establish because of the numerous and various factors that should be considered. Refer to Chapter 3 for criteria that may be used for crossing closure and to Section 8A.05 of the MUTCD for provisions relevant to crossing closure. Additional information regarding grade crossing closure and improvement programs can be found on pages 485–486 of the *Traffic Control Devices Handbook*.⁽²⁾ It is important that these criteria not be used without professional, objective, engineering, and economic assessment of the positive and negative impacts of crossing closures.

When a crossing is permanently closed to highway traffic, the crossing surface and approaches should be obliterated and removed, leaving as few traces of the former crossing as is practicable. When a crossing is closed to train traffic, the highway authority, where practical, should remove the tracks within the highway to reduce future maintenance costs. Paving over tracks with asphaltic paving is not recommended because it is possible for “reflection cracks” to subsequently emerge.

Generally, the railroad is responsible for removing the crossing surface and traffic control devices located at the crossing, such as the Crossbuck sign, flashing-light signals, and gates. The railroad is also generally responsible for restoring the ditch line and removing any evidence of a crossing on railroad property, including the drainage.

Depending on the agreement between a highway authority and the operating railroad(s), the highway authority may be responsible for actions including but not limited to the following:

- Removing traffic control devices in advance of the crossing, such as the advance warning signs and pavement markings.
- Upon termination of any interconnection in cooperation with the railroad, the highway authority may be charged with making any adjustments to the highway traffic signal system, now that the interconnection has been severed, and railroad preemption will no longer occur. The MUTCD shows examples of some effective road closure traffic controls in Part 6. Many States also have effective, MUTCD-compliant road closure signing packages in their standards.
- Installing warning and regulatory signing in accordance with the MUTCD to alert motorists that the crossing is now closed. These signs include the “ROAD CLOSED” sign (R11-2), “LOCAL TRAFFIC ONLY” sign (R11-3, R11-4), and appropriate advance warning signs as applicable to the specific crossing.
- Removing roadway surface approaches.

Consideration should also be given to advising motorists of alternate routes across the railroad. If motorists use the crossing being closed, they should be given advance information about the closure at points where they can conveniently alter their route. Consideration should be made for pedestrian activity at closures as well; nearby, easy alternative routes should be provided for pedestrians to use to discourage trespassing.

CROSSING CONSOLIDATION AND SAFETY PROGRAMS

A highly effective approach to improving safety involves the development of a program of treatments to eliminate significant numbers of crossings within a segment of rail line while improving those that are to remain at grade. Both FRA⁽¹⁰⁾ and American Association of State Highway and Transportation Officials (AASHTO)⁽¹²⁾ have developed guidelines for crossing consolidation. State departments of transportation, road authorities, and local governments may choose to develop their own criteria for closures based on local conditions. Whatever the case, a specific criterion or approach should be used to avoid arbitrarily selecting crossings for closure.

Preparation of a “traffic separation study” is a good way to start. As part of a comprehensive evaluation of traffic patterns and road usage for an entire municipality or region, traffic separation studies determine the need for improvements and/or elimination of public highway-rail crossings based on specific criteria. Traffic separation studies progress in three phases: preliminary planning, study, and implementation.

Crossing information is collected at all public crossings in the municipality. Evaluation criteria include collision history, current and projected vehicular and train traffic, crossing condition, school bus and emergency routes, types of traffic control devices, feasibility for improvements, and economic impact of crossing closures. After discussions with the parties involved, these recommendations may be modified. Reaching a consensus is essential prior to scheduling presentations to governing bodies and citizens.

A key element of a traffic separation study is the inclusion of a public involvement element, including crossing safety workshops and public hearings. The goal of these forums is to exchange information and convey the community benefits of enhanced crossing safety, including the potential neighborhood impacts from train derailments involving hazardous materials that can result from crossing collisions.

The following examples describe crossing consolidation as undertaken by different stakeholders:

State Program Example—North Carolina Department of Transportation (NCDOT)

Many States have crossing closure programs and procedures: Although older, a relevant example of a closure program is the effort begun by the NCDOT in 1993. North Carolina recorded its 300th crossing closure in 2017 and the NCDOT “Sealed Corridor” effort is an excellent model of a State-level crossing program which included grade separations, crossing closures, and improvements including four quadrant gate systems, medians, and test of vehicle detection radar to crossings left open.⁽¹³⁾ The NCDOT’s crossing closure criteria considers the following:

- Crossings within one-quarter-mile of one another that are part of the same highway or street network

- Crossings where vehicular traffic can be safely and efficiently redirected to an adjacent crossing
- Crossings where a high number of crashes have occurred
- Crossings with reduced sight distance because of the angle of the intersection, curve of the track, trees, undergrowth, or man-made obstructions
- Adjacent crossings where one is replaced with a bridge or upgraded with new signaling devices
- Several adjacent crossings when a new one is being built
- Complex crossings where it is difficult to provide adequate warning devices or that have severe operating problems, such as multiple tracks, extensive railroad-switching operations, or long periods of blocked crossings
- Private crossings for which no responsible owner can be identified
- Private crossings where the owner is unable or unwilling to fund improvements and where alternate access to the other side of the tracks is reasonably available

The NCDOT considers the following factors in deciding whether to close or improve a crossing:

- Collision history
- Vehicle and train traffic (present and projected)
- Type of roadway (e.g., thoroughfare, collector, local access, truck route, school bus route, or designated emergency route, etc.)
- Economic impact of closing the crossing
- Alternative roadway access
- Type of property being served (e.g., residential, commercial, or industrial, etc.)
- Potential for bridging by overpass or underpass
- Need for enhanced warning devices (four-quadrant gates, longer arm gates, or median barriers)
- Feasibility for roadway improvements
- Crossing condition (geometry, sight distance, and crossing surface)
- Available federal, State, and/or local funding

Closure implementation strategies used by NCDOT include the following:

- Constructing a connector road or improving roadways along alternate routes to direct traffic to an adjacent crossing
- Dead-ending affected streets and rerouting traffic, creating cul-de-sacs
- Constructing bridges
- Relocating or consolidating railroad operations

Local Program Example—San Gabriel Valley Council of Governments (SGVCOG)

A local grade crossing closure program developed in the San Gabriel Valley in Southern California is one of the largest local programs of crossing improvements, closures, and grade separations. The SGVCOG conducted a study of 55 grade crossings which identified 19 grade separations to eliminate 23 crossings as well as improvements to crossings remaining at grade.⁽¹⁴⁾ SGVCOG obtained local funding and established the Alameda Corridor—East Construction Authority in 1998. In 2018, the Authority was advancing the final grade separations for construction and is nearing the final stages of a large program which includes 19 grade separations to eliminate 23 at-grade crossings along with implementing safety and mobility upgrades at 53 crossings.⁽¹⁵⁾

Railroad Program Example—BNSF Railway Company (BNSF)

One crossing closure initiative was established by BNSF in 2000.⁽¹⁶⁾ This initiative is part of BNSF's crossing safety program, which has the goal of reducing crossing collisions, injuries, and fatalities. The crossing safety program also includes community education, enhanced crossing technology, crossing resurfacing, vegetation control, installation of warning devices, and track and signal inspection and maintenance. In March 2006, BNSF closed its 3,000th highway-rail crossing since the beginning of its crossing closure initiative. By eliminating unnecessary and redundant crossings, BNSF has made an important contribution to community safety while also improving the efficiency and safety of its rail operation. The following are the three key elements of BNSF's crossing closure initiative:

- A closure team was assembled, bringing together field safety and the public projects group in engineering.
- Division engineering and transportation personnel identified closure candidates.
- A closure database was developed to track progress.

INACTIVE OR ABANDONED CROSSINGS

The first step in addressing the problem of crossings on abandoned rail lines is to obtain information on actual abandonments from the Surface Transportation Board (STB) or a State regulatory commission. Railroads are required to apply to STB for permission to abandon a rail line (49 CFR Part 1152). In addition, some State laws require railroads to also apply for State permission or to notify a State agency of intent to abandon a railroad line. The State highway representative responsible for crossing safety and operations should be notified of these intentions. The State highway agency might work out an agreement with the State regulatory commission that any information on railroad abandonments is automatically sent to the State highway agency. Railroad personnel responsible for crossing safety and operations should also seek the same information from their operating departments.

In a case where the railroad line has been abandoned, but the unused crossing warning devices remain in place, unnecessary delays may result, particularly for special vehicles required by federal and State laws to stop at every crossing. Additionally, if rail features such as track and warning devices are left in place on abandoned lines, road users may become conditioned to

ignoring such features, thus potentially reducing the credibility of crossing warning devices on other crossings.

The desirable course of action for abandoned crossings is to remove all traffic control devices related to the crossing and remove the tracks. The difficulty is in identifying a statutorily abandoned railroad line, as opposed to a railroad that has simply fallen into disuse but remains open for railroad purposes. For example, a railroad may discontinue service over a line or a track with the possibility that another railroad, particularly a short-line railroad, may later purchase or lease the line to resume that service. These railroad lines are called inactive lines and removing the track will add substantial cost when reactivating the service.

Another type of inactive rail line is one with seasonal service. For example, rail lines that serve grain elevators may only have trains during harvest season. The lack of use during the rest of the year may cause the same safety and operational problems described earlier.

Once a rail line has been identified as already abandoned or as a candidate for abandonment, the crossings on that line should be identified. This can be determined from the State inventory of crossings or obtained from FRA, custodian of the USDOT National Highway-Rail Crossing Inventory. A field inspection of these crossings should be made to determine if all crossings on that line, both public and private, are listed in the inventory as well as to verify the type of crossing warning devices located at each crossing.

This field inspection provides an excellent opportunity to assess the safety and operations of each crossing on that line. If the rail line is not abandoned, the necessary information has been gathered to improve each crossing by one of the alternatives described in following sections.

If rail service has been discontinued, pending resolution of the abandonment application and formal abandonment, immediate measures should be taken to inform the public. For example, “EXEMPT” signs, if authorized by State law or regulation, can be placed at the crossing to notify drivers of special vehicles that a stop at the crossing is not necessary. Gate arms should be removed and flashing-light signal heads should be hooded, turned, or removed. However, if train service is resumed, 49 CFR 234.247 requires that the crossing warning devices be operational and all FRA-required tests and inspections be conducted prior to operating any trains over the crossing.

The track should be physically removed and all traffic control devices removed following official abandonment if no possibility exists for resumption of rail service. This can be determined by examining the potential for industry or business to require rail service. For example, if the rail line was abandoned because the industry that required the service has moved and other plans for the land area have been made, it could be determined whether need for the rail service will continue. An agreement may be necessary between the public authority and the railroad to accomplish the physical removal of the tracks.

REMOVAL OF GRADE SEPARATION STRUCTURES

The FRA data indicates as of 2017, there were approximately 36,000 public grade-separated highway-rail crossings in the United States—more than half of these grade-separated crossings have a bridge or highway structure over the railroad tracks. As these structures age, become

damaged, or are no longer needed because of changes in highway or railroad alignment, an engineering evaluation should be performed to determine whether the structures should be upgraded or removed.

Currently, there are no nationally recognized guidelines for evaluating the alternatives available for the improvement or replacement of grade-separation structures; however, some States have developed evaluation methods for the selection of projects to remove grade-separation structures.

State Level Guidance—Pennsylvania

The purpose of the Pennsylvania guidance is to assist highway department personnel in the selection of candidate bridge removal projects where the railroad line is abandoned. Both bridges carrying highway over railroad and bridges carrying abandoned railroad over highway can be considered. The factors to be considered in selecting candidate projects are as follows:

For bridges carrying highway over an abandoned railroad:

- Bridges that are closed or posted for a weight limit because of structural deficiencies (the length of the necessary detour is important)
- Bridges that are narrow and therefore hazardous
- Bridges with hazardous vertical and/or horizontal alignment of the highway approaches (accident records can be reviewed to verify such conditions)

For bridges carrying abandoned railroad over a highway:

- Bridges that are structurally unsound and a hazard to traffic operating under the bridge
- Bridges whose piers and/or abutments are near the traveled highway and constitute a hazard
- Bridges whose vertical clearance over the highway is substandard
- Bridges where the vertical and/or horizontal alignment of the highway approaches are hazardous primarily because of the location of the bridge

It should be noted that this guidance is applicable to situations that involve abandoned rail lines.

In instances where a railroad continues to operate, some questions to consider prior to removing a grade separation over or under a rail line are as follows:

- Can the structure be removed and replaced with a crossing?
- Who is liable if an accident occurs at the new crossing?
- If the structure is to be rebuilt, who is to pay the cost or who is to share in the cost and to what extent?
- To what standards is the structure to be rebuilt?
- What is the future track use and potential for increase in train frequency?

- If the structure is replaced with a crossing, what delays to motorists and emergency service will result? Are alternate routes available?
- What impact will a crossing have on railroad operations?
- What will be the impact on safety of a crossing versus a structure?

To ensure a proper answer to these and other related questions, an engineering evaluation, including relative costs, should be conducted. This evaluation should follow procedures described in Chapter 3 of this document.

RELOCATION

Other alternatives to highway-rail crossing improvement programs are relocation of the highway or railroad, or railroad consolidation. These alternatives provide a solution to railroad impacts on communities such as noise, traffic delays, and the land use “barrier” effect of a rail corridor; however, the costs associated with relocation or consolidation can be high.

Benefits of railroad relocation in addition to those associated with crossing safety and operations include improved environment resulting from decreased noise and air pollution, improved land use and appearance, and improved railroad efficiency. Railroad relocation and consolidation may also eliminate obstructions to emergency vehicles and provide safer movement of hazardous materials. Collectively, the tangible and intangible benefits may justify the relocation or consolidation of railroad facilities; any one of the benefits alone might not provide sufficient justification for the expense.

Many factors should be considered in planning for railroad relocation. The new location should provide proper alignment, minimum grades, and adequate drainage. Sufficient ROW should be available to provide the necessary horizontal clearances, additional rail facilities as service grows, and a buffer for abating noise and vibrations. The number of crossings should be minimized.

The railroad corridor can be further isolated from residential and commercial activity by zoning the property adjacent to the railroad as light and heavy industrial. Businesses and industry desiring rail service can locate in this area.

Highway relocations are sometimes accomplished to provide improved highway traffic flow around communities and other developed areas. Planning for highway relocations should consider routes that eliminate crossings by avoiding the need for access over railroad tracks or by providing grade separations.

SITE IMPROVEMENTS

In addition to the installation of traffic control systems, site and operational improvements can significantly contribute to the safety of highway-rail crossings. Site improvements are discussed in four categories: crossing geometry, removing obstructions, illumination, and safety barriers.

Crossing Geometry

The ideal crossing geometry is a 90-degree intersection of track and highway with slight-ascending grades on both highway approaches to reduce the flow of surface water toward the crossing. Few crossings have this ideal geometry because of topography or limitations of ROW for both the highway and the railroad. Every effort should be made to construct new crossings in this manner. Horizontal and vertical alignment and cross-sectional design are discussed below.

Horizontal Alignment

Ideally, the highway should intersect the tracks with a minimum skew with no nearby intersections or driveways. This layout enhances the driver's view of the crossing and tracks and reduces conflicting vehicular movements from crossroads and driveways. To the practical extent, crossings should not be located on either highway or railroad curves. Roadway curvature inhibits a driver's view of a crossing ahead, and a driver's attention may be directed toward negotiating the curve rather than looking for a train. Railroad curvature inhibits a driver's view down the tracks from both the approach to the crossing and from a stopped position at the crossing. Crossings located on both highway and railroad curves present maintenance problems and poor rideability for highway traffic if conflicting superelevation is present. Similar difficulties arise when superelevation of the track is opposite to the grade of the highway.

If the intersection between track and highway cannot be made at right angles, the variation from 90 degrees should be minimized. At skewed crossings, motorists must look over their shoulders to view the tracks. Because of this more awkward movement, some motorists may only glance quickly and not take necessary precautions.

Improvements to horizontal alignment can be expensive, depending on the extent of construction required. Special consideration should be given to crossings that have complex horizontal geometries, as described previously. These crossings may warrant the installation of active traffic control systems or, if possible, may be closed to highway traffic.

Crossing Profile —Vertical Alignment

It is desirable that the intersection of highway and railroad be as level as possible from the standpoint of sight distance, rideability, and braking and acceleration distances. Positive drainage is provided if the crossing is located at the peak of a vertical curve on the highway; however, the curve should be adequately flat to avoid hanging-up of vehicles and of sufficient length to ensure an adequate view of the crossing consistent with the highway design or operating speed.

When constructing new highway-rail at-grade crossings or enhancing existing locations, care should be taken to create horizontal and vertical profiles that provide smooth and safe travel for motorists approaching and using crossings. Vehicles or trailers low to the ground relative to the distance between axles pose the greatest risk of becoming stuck at crossings due to contact with the track or highway surface. Similarly, a low vehicle's front or rear bumper overhang may strike or drag along the pavement surface in a sag vertical curve.

The AASHTO presents a guideline which is traversable by a wide range of vehicles including those with long wheelbases and/or low ground clearance (this standard is also provided by AREMA). Shown in **Figure 1**, the guideline recommends that the crossing surface be in the same plane as the top of rails for a distance of 2 feet outside of the rails, and that the surface of the highway be not more than 3 inches higher or lower than the top of the nearest rail at a point 30 feet from the rail for new construction.

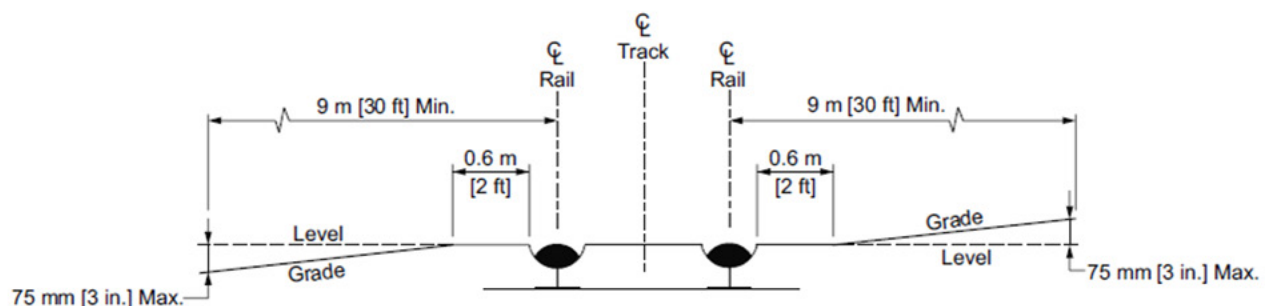

Figure 1. Highway-Rail Crossing Cross Section

Source: Figure 9-102, A Policy on Geometric Design of Highway and Streets, Washington, DC, AASHTO, 2018. Used by permission.

Low-clearance vehicles pose the greatest risk of becoming immobilized at highway-rail crossings due to contact with the track or highway surface. Except for specialized vehicles such as tank trucks, there is little standardization within the vehicle manufacturing industry regarding minimum ground clearance. Instead, the requirements of shippers and operators guide manufacturers.⁽¹⁷⁾

Two constraints often apply to the maintenance of crossing profiles: drainage requirements and resource limitations. Coordination of maintenance activities between rail and highway authorities, especially at the city and county levels, can be frequently informal and unstructured. Even when the need to coordinate has been identified, there may be a lack of knowledge regarding whom to contact. For these reasons, it is important to note that with any routine track

work, or any highway/roadway surface repaving work to be performed, notification of all parties, and acknowledgement of receipt of notice, should occur prior to any work commencing.

Existing crossings constructed on an embankment for drainage purposes may be problematic for low ground clearance vehicles to negotiate. Historically, track maintenance may have raised the track over time if additional ballast was placed beneath the ties. Unless the highway profile was also adjusted, this practice can result in a “humped” profile that may adversely affect the safety and operation of highway traffic over the railroad. Modern maintenance equipment and practices re-set the track structure and “tamp” the ballast in place without modifying the track elevation.

In some cases, highway authorities become aware of increases in track elevation only after maintenance activities have taken place. As a result, even if State standards exist, there is little opportunity to enforce them. Often, an individual increase in track elevation may not violate a guideline, but successive track raises may slowly create a high-profile crossing. Over time, this can result in a condition referred to as a “hump crossing.”

Strategies to address this problem could include the following:

- Designing a standard with maximum grades at the crossing
- Prohibiting truck trailers with a certain combination of under-clearance and wheelbase from using the crossing
- Setting trailer design standards
- Posting warning signs in advance of the crossing
- Minimizing the rise in track due to maintenance operations

Because of the previously noted variations in vehicle configurations, it is difficult to determine whether a crossing which does not meet the AASHTO guideline is traversable by all long wheelbase and low ground clearance vehicles. Also, there are many crossings which do not meet the AASHTO guideline exactly but nevertheless are unlikely to strand low ground clearance vehicles.

The Florida Department of Transportation (FDOT) published *Design Guidelines for Highway Railroad Grade Crossing Profiles in Florida*.⁽¹⁸⁾ This document provides an in-depth discussion of the technical issues, lists various standards in use, and presents more practicable solutions for development of crest and sag curves which would prevent hang-up of low clearance vehicles. **Figure 2** shows a crest curve treatment using three vertical curves. The project also resulted in the development of software known as HANGUP for evaluation of crossing profiles.

At locations where the profile is sufficiently abrupt to potentially immobilize vehicles, a Low Ground Clearance Grade Crossing (W10-5) warning sign and a LOW GROUND CLEARANCE (W10-5P) supplemental plaque, **Figure 3**, may be installed for each direction of travel to warn drivers of long wheelbase vehicles or drivers of vehicles that have a low ground clearance that they might encounter a hang-up situation if they attempt to use the crossing. (**Figure 4** shows a typical treatment.) The USDOT Crossing Inventory Form⁽¹⁹⁾, in Part III, Box 2E, provides a place to indicate if a crossing has such signs installed.

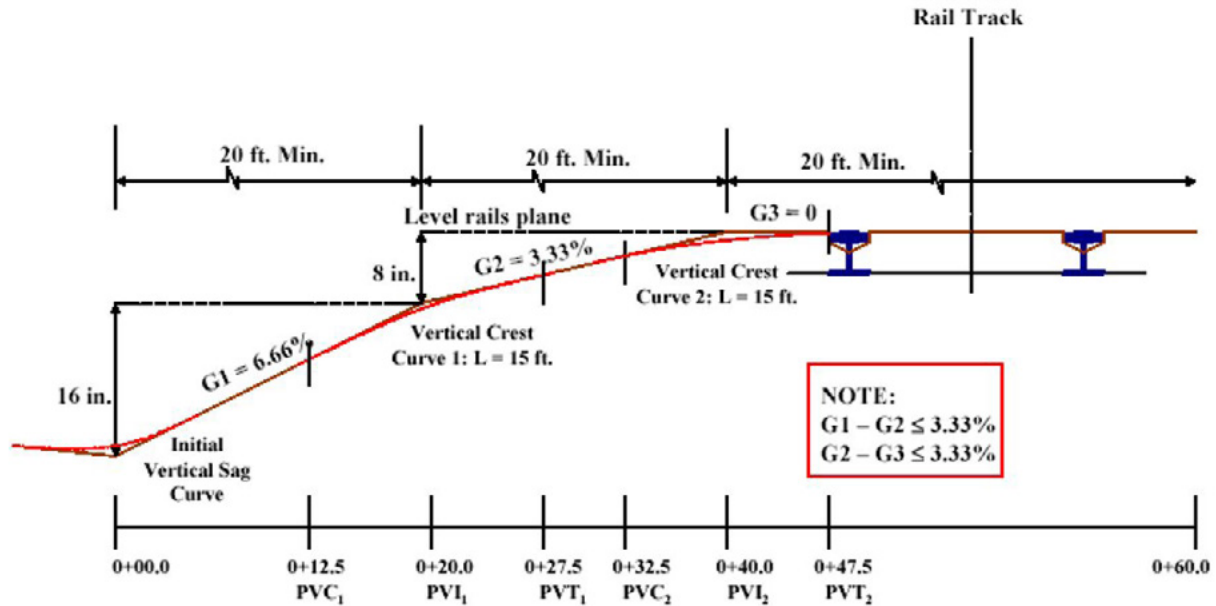

Figure 2. Fitting Three Vertical Curves to an Approach to a Railroad Crossing Profile

Source: Sobanjo, J., Design Guidelines for Highway Railroad Grade Crossing Profiles in Florida, Figure 4.6, Florida State University, May 2006.

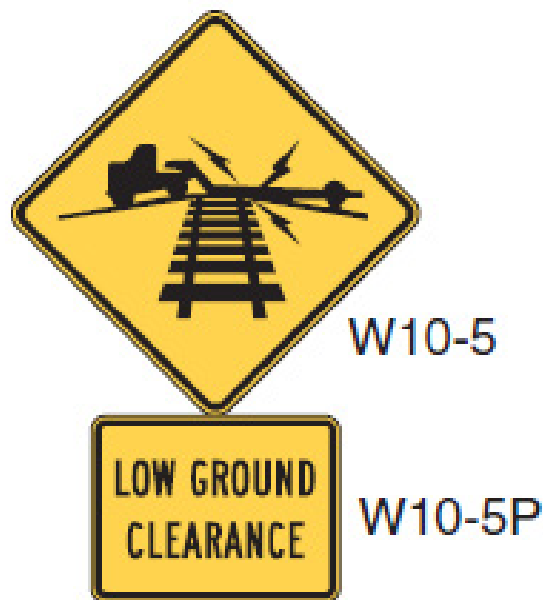

Figure 3. Low Ground Clearance Warning Signs

Source: Manual on Uniform Traffic Control Devices, 2009 Edition.

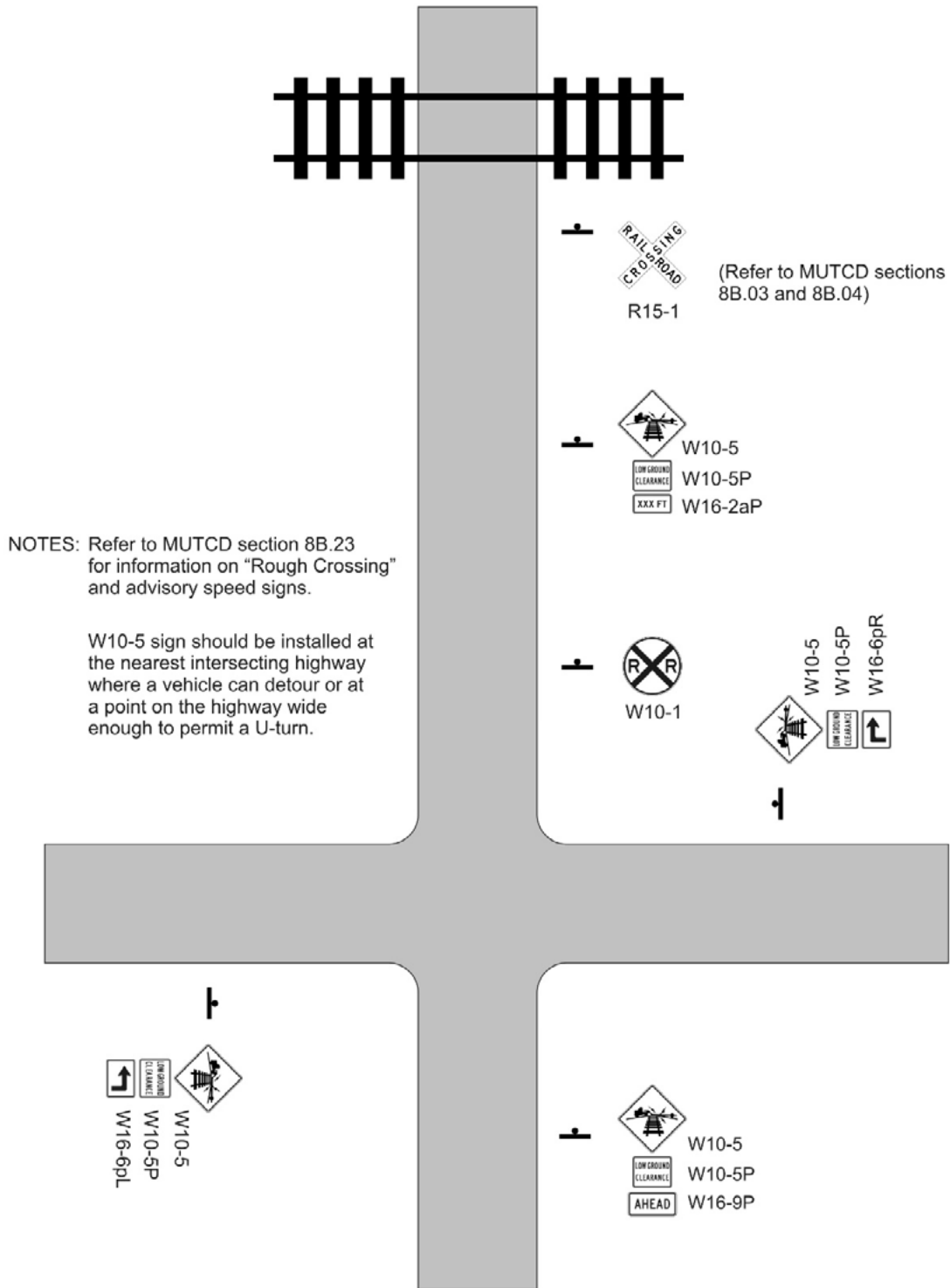

Figure 4. Treatment for Low Ground Clearance

Source: Seyfried, R. K., (Ed.), *Traffic Control Devices Handbook, 2nd Edition, Figure 11-5, Washington, DC, ITE, 2013.*

Removing Obstructions and Sight Distance

Clear Zone

Outside of urban areas, where the approach roadway has a shoulder area, it is desirable to provide a “clear zone” approaching the crossing. A clear zone is an unobstructed, traversable roadside area that allows a driver to stop safely or to regain control of a vehicle that has left the roadway.⁽²⁰⁾ This area should be free from obstacles such as unyielding sign and luminaire supports, non-traversable drainage structures, trees larger than 4 inches in diameter, utility or railroad line poles, or steep slopes. Design options for mitigating these features are generally considered in the following order:

- Remove the obstacle or redesign it so that it can be safely traversed
- Relocate the obstacle to a point where it is less likely to be struck
- Reduce impact severity by using an appropriate breakaway device
- Redirect a vehicle by shielding the obstacle by use of a longitudinal barrier or crash cushion
- Delineate the obstacle if the above alternatives are not appropriate

The term “clear zone” is also used to refer to a zone within the railroad corridor along the tracks free of sight distance restrictions. For example, Illinois regulations require a 500-foot clear zone which is to be kept “reasonably clear of brush, shrubbery, trees, weeds, crops, and all unnecessary permanent obstructions such as unauthorized signs and billboards.”⁽²¹⁾

Sight Distance

Adequacy of sight distance is critical at passive crossings; however, even where active devices are present or will be provided, sight distance is beneficial to confirm the ability to cross the tracks. The discussion on the following pages defines “desired” roadway user response based upon available sight distance. Drivers may not exercise best judgment under all conditions. The existence of sight distance deficiencies which cannot be corrected should consider the use of active devices at the crossing. (Refer to [Appendix C](#) for discussion of sight distance evaluation as part of a field diagnostic review of a specific crossing.)

The *Traffic Control Devices Handbook (2nd Edition)* indicates three zones within the approach to a crossing where drivers make decisions about their movements in relation to the crossing.⁽²⁾ **Figure 5** shows the three zones as well as the respective sight distance associated with each (d_H and d_T represent the respective distances from the crossing for the highway vehicle and train, and MTC_D refers to the “minimum track clearance distance” at the crossing, which should be clear of vehicles when a train is approaching). **Table 2** indicates for each zone the desired roadway user response, depending upon whether a train is visible.

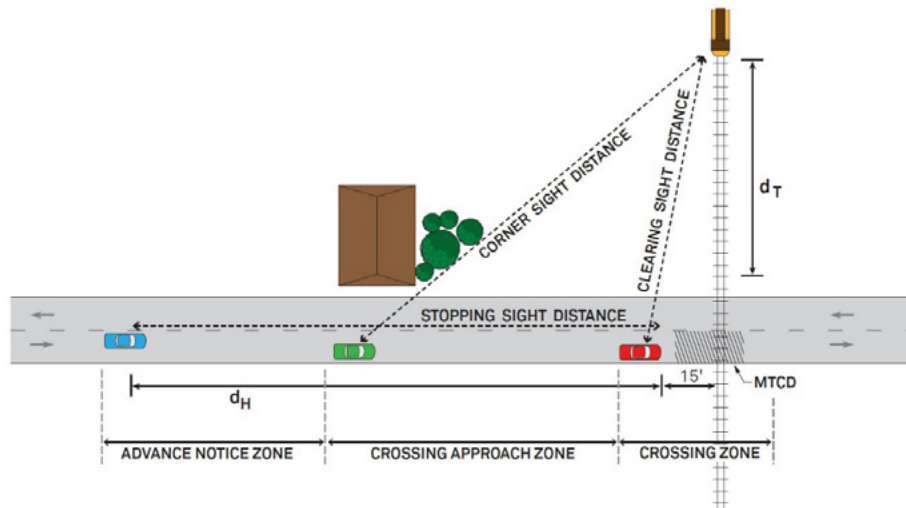

Figure 5. Approach Regions with Passive Traffic Control Devices

Source: *Traffic Control Devices at Grade Crossings, Figure 11-15, Washington, DC, ITE, 2013.*

It is desirable that sight distances permit operation at the design speed of the approach roadway to the greatest degree practical. To permit this, three areas should be kept free from obstruction: the advance notice zone, where the road user first realizes there is a crossing ahead, the crossing approach zone where adequate corner sight distance is desirable, and the crossing zone where clearing sight distance is required.

Table 2 highlights the *Traffic Control Devices Handbook* guidance for sight distance.⁽²⁾

Table 2. Sight Distance Zones

Region	Sight Distance Criteria	Information Acquired by Roadway User	Desired Roadway User Response
Advance Notice Zone	Stopping Sight Distance	Grade crossing ahead (train may be at crossing)	Look ahead and to both sides for more information; consider safe approach speed; stop if necessary
Crossing Approach Zone	Corner Sight Distance	Grade crossing ahead (train may be at crossing)	Slow down; stop ahead of crossing
		Train in crossing	Slow down; stop ahead of crossing if train may arrive at crossing before roadway vehicle can clear the Crossing Zone
		Train approaching	Slow down if corner sight distance impaired; prepare to stop if necessary
Crossing Zone (including MTCD)	Clearing Sight Distance	No train visible	Stop; wait for train to pass
		Train in crossing	Stop ahead of crossing if required to do so by law; proceed with caution if roadway user can clear the Crossing Zone before train arrival
		Train approaching	Stop if required to do so by law; proceed through crossing
		No train visible	Look ahead and to both sides for more information; consider safe approach speed; stop if necessary

Approach Sight Distance

The first region of concern is the approach sight distance where the road user becomes aware of the presence of a crossing ahead. The approach area from the road user to the crossing should be evaluated to determine whether it is feasible to remove any obstructions that prevent the motorist from viewing the crossing ahead, a train occupying the crossing, or active control devices at the crossing.

Obstructions in this area can be traffic control devices, roadside commercial signing, utility and lighting poles, or vegetation. Horizontal and vertical alignment can also serve to obstruct motorists' view of the crossing. Clutter can sometimes be removed with minimal expense, improving the visibility of the crossing and associated traffic control devices. Traffic control devices unnecessary for the safe movement of vehicles through the crossing area should be relocated if possible. Vegetation should be removed or cut back periodically. Billboards should be prohibited on the approaches.

Corner Sight Distance

The second region of concern is the corner sight distance which allows an approaching road user the ability to see an approaching train. View obstructions often exist within the sight triangle, typically caused by structures, topography, crops or other vegetation (continually or seasonal), movable objects, or weather (fog or snow). Where restricted sight distances exist, motorists should reduce speed and be prepared to stop no less than 15 feet before the near rail, unless and until they are able to determine, based upon the available sight distance, that there is no train approaching and it is safe to proceed. Wherever possible, sight line deficiencies should be improved by removing structures or vegetation within the affected area, regrading an embankment, or realigning the highway approach.

Many conditions, however, may be difficult to correct because the obstruction is on private property or it is economically infeasible to correct the sight line deficiency. If available corner sight distance is less than what is required for the legal speed limit on the highway approach, supplemental traffic control devices, such as enhanced advance warning signs, or reduced speed limits (advisory or regulatory) should be evaluated. If the responsible highway authority wishes to allow vehicles to travel at the legal speed limit on the highway approach, active warning devices should be considered.

Changes to horizontal and vertical alignment can be more expensive, depending on the scope of the desired change. When constructing new highways or reconstructing existing highways, however, care should be taken to minimize the effects of horizontal and vertical curves at a crossing.

Clearing Sight Distance

The third region of concern is the clearing sight distance, which pertains to the visibility available to a road user along the track when stopped ahead of the crossing. Usually, this area is located on railroad ROW. Vegetation is often desired along railroad ROW to serve as an environmental barrier to noise generated from train movements; however, safety at crossings is of more importance and, if possible, vegetation within the rail right-of-way should be removed or cut back periodically. States or other authorities may require clear sight lines of 500 feet in each direction ([refer to prior discussion on Clear Zones](#)). Also, if practical, this sight distance area should be kept free of parked vehicles and standing railroad cars or locomotives. Care should be taken to avoid the accumulation of snow in this area.

Table 3 provides clearing sight distance for cars, trucks, and pedestrians. The person or agency evaluating the crossing should determine the specific design vehicle, pedestrian, bicyclist, or other non-motorized conveyance and compute clearing sight distance if it is not represented in **Table 3** using formulas provided in AASHTO *A Policy on Geometric Design of Highways and Streets, 7th Edition*, Chapter 9, Section 12.⁽²²⁾ Note that the table values are for a level, 90-degree crossing of a single track. If other circumstances are encountered, the values should be recomputed using the equations shown in AASHTO.

Table 3. Clearing Sight Distance Criteria by Mode

Train Speed	73.5-foot Double Truck ^(a)	Car ^(b)	Pedestrian ^(b)
10	255	105	180
20	509	205	355
30	794	310	530
40	1,019	410	705
50	1,273	515	880
60	1,528	615	1,060
70	1,783	715	1,235

Sources: (a) *A Policy on Geometric Design of Highways and Streets*, AASHTO, Washington, DC, 2018; (b) *Guidance on Traffic Control Devices at Highway-Rail Grade Crossings*, Highway/Rail Grade Crossing Technical Working Group, Washington, DC, 2002.

If there is insufficient clearing sight distance, and the driver is unable to make a safe determination to proceed, the clearing sight distance needs to be improved to safe conditions or flashing-light signals with gates, closure, or grade separation should be considered.

An engineering study should be conducted to determine if the three types of sight distance can be adequately provided. If not, other alternatives should be considered. The posted highway speed might be reduced to a level that conforms to the available sight distance. It is important that the motorist understand why the speed reduction is necessary, otherwise, it may be ignored unless enforced. At crossings with passive control devices only, consideration might be given to the installation of active traffic control devices that warn of the approach of a train.

Illumination

Illumination at a crossing may be effective in reducing nighttime collisions. Illuminating most crossings is technically feasible because nearly all crossings have commercial power available. Illumination may be effective under the following conditions:

- Nighttime train operations
- Low train speeds
- Blockage of crossings for long periods at night
- Collision history indicating that motorists often fail to detect trains or traffic control devices at night
- Horizontal and/or vertical alignment of highway approach such that vehicle headlight beam does not fall on the train until the vehicle has passed the safe stopping distance
- Restricted sight or stopping distance in rural areas
- Humped crossings where oncoming vehicle headlights are visible under trains
- Low ambient light levels
- A highly reliable source of power

Luminaires may also provide a low-cost alternative to active traffic control devices on industrial or mine tracks where switching operations are carried out at night.

Figure 6 shows a typical layout where a minimum of two luminaires are placed in opposite approach quadrants to illuminate the crossing and a 100-foot approach zone. Luminaire supports should be placed in accordance with the principles in the *Roadside Design Guide*⁽²³⁾ and the *Manual for Assessing Safety Hardware*⁽²⁴⁾. If they are placed in the clear zone on a high-speed road, they should be breakaway.

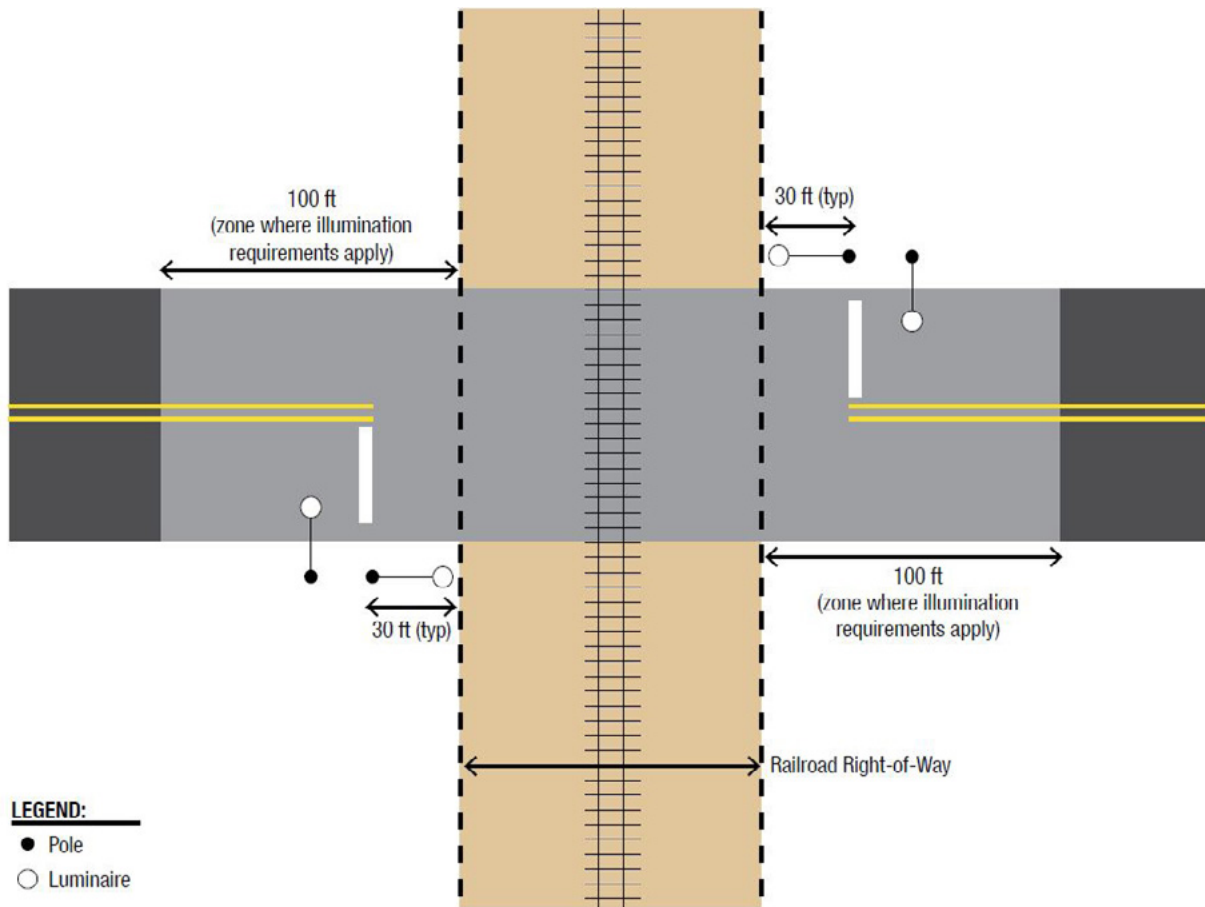

Figure 6. Pole and Luminaire Locations Where a Railroad ROW Crosses a Public Roadway

Source: Institute of Transportation Engineers.

Illumination guidance for crossings is provided in the ANSI/IES publication RP-8-14.⁽²⁵⁾ Illumination requirements for the 100-foot approach zone range from 3 lux (concrete) to 9 lux (smooth asphalt). According to the ANSI/IES RP-8-14, there are several factors affecting visibility. As these factors heighten/increase, the visibility level of the target can significantly increase or decrease. The factors which should be taken into consideration include the following:

- Adaptation level—relative contrast sensitivity
- Age of the observer
- Contrast
- Disability glare
- Size
- Time of viewing
- Transient adaptation

Safety Barriers and Crossing Surfaces

Guardrails and Crash Cushions

The purpose of a traffic barrier, such as a guardrail or crash cushion, is to protect the motorist by redirecting or containing an errant vehicle. The purpose is not to protect a traffic control device against collision and damage. The use of a traffic barrier should be limited to situations in which hitting the object, such as a traffic control device, is more hazardous than hitting the traffic barrier and redirecting the vehicle into a train.

Longitudinal guardrails should not be used for traffic control devices at crossings unless the guardrail is otherwise warranted, such as for a steep embankment. The longitudinal guardrail might redirect a vehicle into a train. The ring type guardrail placed around a signal mast may be used at locations with heavy industrial traffic, such as trucks, and low highway speeds. Care should be taken not to create the same type of hazard as the signal mast itself (the guardrail may be a roadside obstacle).

On some crossings, it may be possible to use crash cushions to protect the motorist from striking a traffic control device. Some crash cushions are designed to capture rather than redirect a vehicle and may be appropriate for use at crossings to reduce the redirection of a vehicle into the path of a train.

A curb over 4 inches in height is not an acceptable treatment where vehicle speeds are high because it may cause vehicles to become airborne if struck at high speed. Curbs should be avoided on high-speed roads but, if needed, the curb can be located at the back of the shoulder. In some cases, curbs closer to the traveled way may be acceptable on a high-speed road where they fulfill an important function, such as blocking an illegal or undesirable traffic movement.

The *Manual for Assessing Safety Hardware* (MASH)⁽²⁴⁾ developed by AASHTO provides current standards for upgrading barriers, crash cushions, and other features. The AASHTO/FHWA jointly established an initiative in 2015 to upgrade existing highways to conform to the MASH standards. More information can be obtained from the *Roadside Design Guide*.⁽²³⁾ An engineering study should be completed to help determine the appropriate barrier treatment.

Crossing Surfaces

The AREMA *Manual of Railway Engineering*, Chapter 5, Part 8,⁽²⁶⁾ provides guidelines for the construction and reconstruction of highway-rail crossings. The first section of Part 8 provides information on the following crossing surface materials:

- Crossing width
- Profile and alignment of crossings and approaches
- Drainage
- Ballast
- Ties
- Rail
- Flange widths
- New or reconstructed track through a crossing

Proper preparation of the track structure and good drainage of the subgrade are essential to good performance from any type of crossing surface. Excessive moisture in the soil can cause track settlement, accompanied by penetration of mud into the ballast section. Moisture can enter the subgrade and ballast section from above, below, and/or adjacent subgrade areas. To the extent feasible, surface and subsurface drainage should be intercepted and discharged away from the crossing. Drainage can be facilitated by establishing an adequate difference in elevation between the crossing surfaces and ditches or embankment slopes. The highway profile at all crossings should be such that water drains away from the crossing.

NEW CROSSINGS

Like crossing closure/consolidation, opening a new public highway-rail crossing should likewise consider public safety, necessity, access, and economics. Generally, new crossings (particularly on mainline tracks) should not be permitted unless no other viable alternatives exist. Even in those instances, consideration should be given to closing one or more existing crossings.

Communities, developers, and highway transportation planners need to be mindful that once a highway-rail crossing is established, drivers can develop a low tolerance for the crossing if blocked by a train for an extended period. If a new access is proposed to cross a railroad where railroad operation requires temporarily holding trains, only grade separation should be considered.

PASSIVE CROSSING TREATMENTS

Passive traffic control devices consist of regulatory signs, warning signs, guide signs, and pavement markings. These devices provide static messages of warning, guidance, and in some instances, mandatory action for the driver. Their purpose is to identify and direct attention to the location of a crossing to permit drivers and pedestrians to take appropriate action. Passive devices may be used at a passive crossing or may be used in conjunction with active devices at an active crossing. ([Refer to the Sight Distance section](#) for a discussion of sight distance requirements for passive crossings.)

Signs and pavement markings are to be in conformance with the MUTCD. New editions of the MUTCD are released periodically. Between MUTCD updates, the FHWA provides official interpretations, manages traffic control device experimentations, and issues interim approvals for new traffic control devices. Practitioners should confirm all signs, dimensions, and criteria with the latest edition of MUTCD.

Signs

Part 8 of the MUTCD includes provisions for use of signs at crossings and contains two figures which provide “sign panels” depicting regulatory and warning signs which are most relevant to crossings (MUTCD Figures 8B-1 and 8B-4). Some of these signs are in general use; others are specific to crossings.

Figure 7 depicts the regulatory sign panel. The “Crossbuck” sign (R15-1) is required to be used on each highway approach to every crossing, alone or in combination with other devices with a minor exception for LRT crossings where its use is optional in semi-exclusive or mixed-use alignments. At passive crossings, the Crossbuck sign is used within a “Crossbuck Assembly” in conjunction with use of a STOP or YIELD sign as further described below. Many of the other regulatory signs such as the NO RIGHT (LEFT) TURN ACROSS TRACKS (R3-1a/R3-2a) blank-out signs, the DO NOT STOP ON TRACKS (R8-8), and the “Stop Here” series (R8-10/10a) and R10-6/6a) signs are used in conjunction with active devices. The signs in the fourth row are for use with LRT or street-running rail.

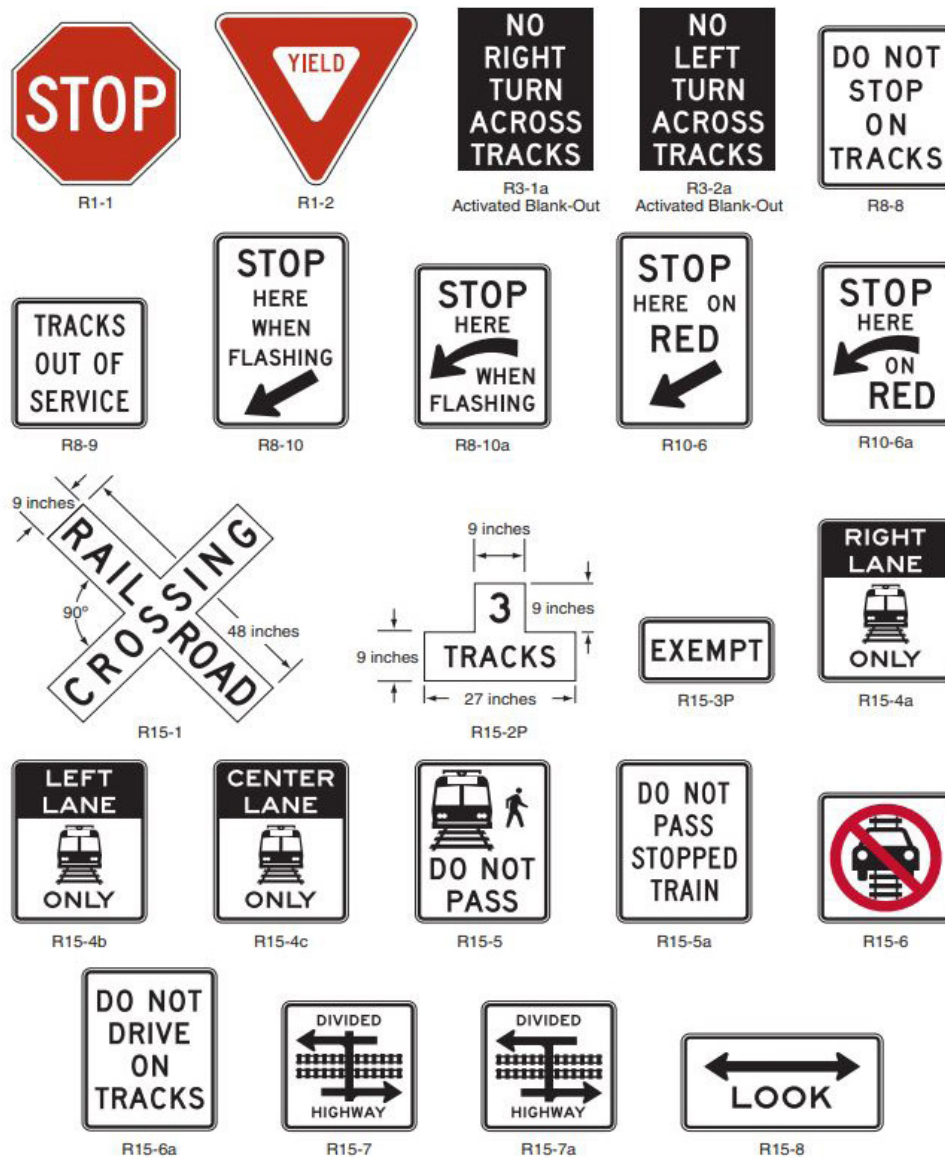

Figure 7. Regulatory Signs and Plaques for Crossings

Source: Manual on Uniform Traffic Control Devices, 2009 Edition. Figure 8B-1 Regulatory Signs and Plaques for Grade Crossings, Washington, DC, FHWA, 2009.

Figure 8 shows the warning sign panel. Part 8 of the MUTCD contains specific standards and guidance for the use of these signs. This section summarizes key requirements and gives examples for specific conditions for which these signs were intended to address.

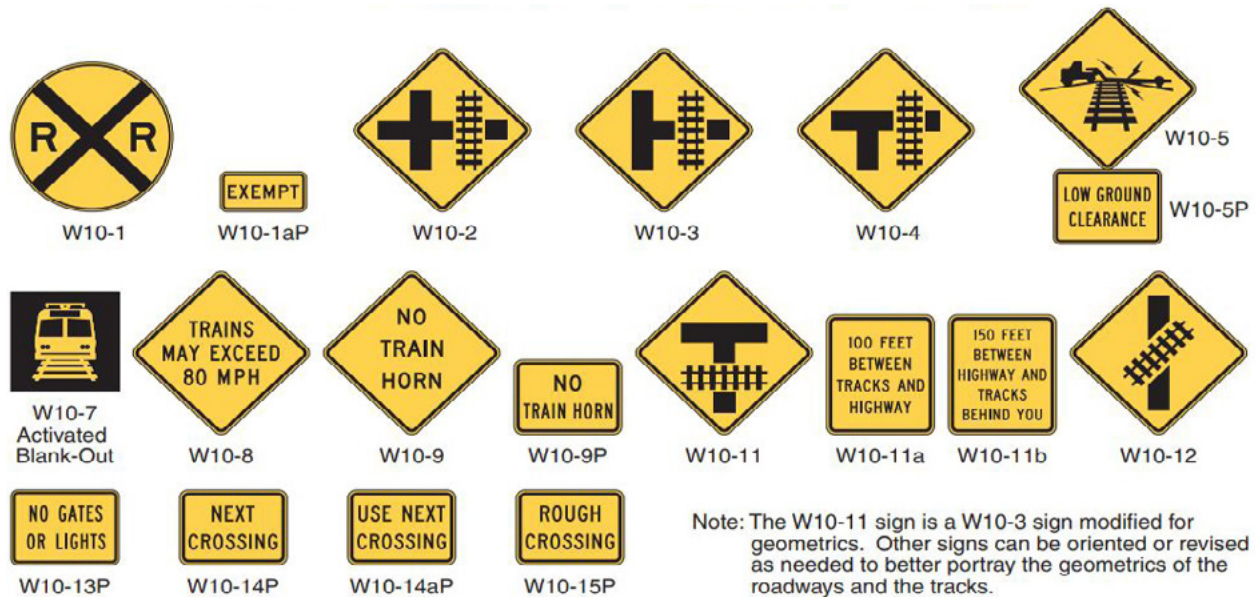

Figure 8. Warning Signs and Plaques for Crossings

Source: Manual on Uniform Traffic Control Devices, 2009 Edition, Figure 8B-4 Regulatory Signs and Plaques for Grade Crossings, Washington, DC, FHWA, 2009.

Table 4 lists all the signs which are included in Part 8 of the MUTCD along with a brief description of the intended application or indication of the need for each.

Table 4. Current MUTCD Signs

Sign Designation	Section	Sign or Plaque	Application or Indication of Need
R3-1	8B.08	No Right Turn	Movement Prohibition
R3-2	8B.08	No Left Turn	Movement Prohibition
R1-1	8B.04, 8B.05	STOP	Standard—A STOP or YIELD sign is required to be used as part of a Crossbuck Assembly at passive crossings (refer to text for specifics).
R1-2	8B.04, 8B.05	YIELD	Standard—A STOP or YIELD sign is required to be used as part of a Crossbuck Assembly at passive crossings (refer to text for specifics).
R8-8	8B.09	Do Not Stop on Tracks	Should be used where an engineering study indicates the potential for vehicles to stop on the crossing is significant.
R8-9	8A.05, 8B.10	Tracks Out of Service	May be used with engineering judgement as a temporary provision before tracks will be removed or paved over.
R8-10, 10a	8B.11	Stop Here When Flashing	May be used at a highway-rail crossing to inform drivers of the location of the stop line or the point at which to stop when the flashing-light signals (Section 8C.02) are activated.
R10-6, 6a	8B.12, 8C.09	Stop Here on Red	May be used at locations where vehicles frequently violate the stop line or where it is not obvious to road users where to stop.
R10-11a	8B.08, 8C.09	No Turn on Red	May be used in conjunction with preemption of a traffic signal to prohibit turning movements toward the tracks (refer to text on preemption).
R15-1	5F.02, 8B.03, 8B.04, 8B.10, 8C.02, 8C.13,	Grade Crossing (Crossbuck)	Standard—Required as part of a Crossbuck Assembly with limited exceptions (refer to text for specifics).
R15-2P	5F.02, 8B.03, 8B.04, 8B.10, 8C.02, 9B.14	Number of Tracks	Standard—Required as part of a Crossbuck Assembly at locations with two or more tracks and no gate; optional with gate.
R15-3P	8B.07	Exempt	Recommended where school buses and commercial vehicles that are usually required to stop at crossings are not required to do so where authorized by ordinance.
R15-4a	8B.13	Light Rail Only Right Lane	May be used for multilane operations where roadway users might need additional guidance on lane use and/or restrictions.
R15-4b	8B.13	Light Rail Only Left Lane	May be used for multilane operations where roadway users might need additional guidance on lane use and/or restrictions.

Sign Designation	Section	Sign or Plaque	Application or Indication of Need
R15-4c	8B.13	Light Rail Only Center Lane	May be used for multilane operations where roadway users might need additional guidance on lane use and/or restrictions.
R15-5	8B.14	Light Rail Do Not Pass	May be used where vehicles are not allowed to pass LRT vehicles that are loading or unloading passengers at locations where no raised platform physically separates the lanes.
R15-5a	8B.14	Do Not Pass Stopped Train	Same as R15-5.
R15-6	8B.15	Do Not Drive On Tracks Light Rail Symbol	May be used where there are adjacent vehicle lanes separated from the LRT track only by a curb or pavement markings.
R15-6a	8B.15	Do Not Drive On Tracks	Same as R15-6.
R15-7	8B.16	Light Rail Divided Highway Symbol	May be used with appropriate geometric conditions.
R15-7a	8B.16	Light Rail Divided Highway Symbol (T-intersection)	Same as R15-7.
R15-8	8B.17, 8C.13	Look	May be used to advise pedestrians to anticipate a train or LRV coming from either direction.
W10-1	8B.06, 8B.25	Grade Crossing Advance Warning	Standard—Required device, with MUTCD exceptions (Section 8B.06).
W10-1aP	8B.07	Exempt	Should be used with W10-1 at Exempt locations (refer to R15-3P).
W10-2,3,4	8B.06, 5F.03	Highway-Rail Grade Crossing Advance Warning	Required on parallel roadways where there is an intersection within 100 feet of a crossing (refer to text for specifics).
W10-5, W10-5P	8B.23	Low Ground Clearance Highway-Rail Grade Crossing	Should be used as indicated by MUTCD guidelines, incident history, or local knowledge.
W10-7	8B.19	Light Rail Activated Blank-Out Symbol	May be used to warn road users of an approaching LRT vehicle.
W10-8	8B.20	Trains May Exceed 80 mph	Should be used where train speed is 80 mph or faster.
W10-9, W10-9P	8B.21, 9B.19	No Train Horn	Required at crossings in FRA-authorized quiet zones.
W10-11	8B.24	Storage Space Symbol	Should be used where there is inadequate clear storage space between the crossing and a downstream intersection, as determined by engineering study.

Sign Designation	Section	Sign or Plaque	Application or Indication of Need
W10-11a	8B.24	Storage Space XX Feet Between Tracks and Highway	Should be used in conjunction with W10-11.
W10-11b	8B.24	Storage Space XX Feet Between Highway Tracks Behind You	May be used in conjunction with W10-11.
W10-12	8B.25, 9B.19	Skewed Crossing	May be used at a skewed highway-rail crossing to warn drivers that the railroad tracks are not perpendicular to the highway.
W10-13P	8B.22	No Gates or Lights	May be installed at highway-rail crossings that are not equipped with active warning devices.
W10-14P	8B.23	Next Crossing	May be used in conjunction with other warning signs to advise drivers of alternate route.
W10-14aP	8B.23	Use Next Crossing	Refer to W10-14P.
W10-15P	8B.23	Rough Crossing	May be used if the highway-rail crossing is rough.
I-13	8B.8	Emergency Notification	Should be installed at all crossings to provide for emergency notification.

Source: Adapted from Manual on Uniform Traffic Control Devices, 2009 Edition. FHWA, Washington, DC, 2009.

The MUTCD Section 2A.16 (Standardization of Location) discusses Standards and Guidance for positions and locations of signage. In general, MUTCD specifies that signs should be located on the right-hand side of the highway, where the driver is looking for them. Signs should be located to optimize visibility. Signs should not be in a highway dip or beyond the crest of a hill. Care should be taken so that the sign is not obscured by parked cars or foliage or covered by roadside splatter or snow accumulation.

Section 8A.04 of the MUTCD discusses the importance of retroreflective or illuminated signs and object markers to meet requirements both by day and by night. MUTCD Section 2A.15 contains a wide range of provisions for increasing sign conspicuity including the use of LED enhancement. Section 2A.07 contains general provisions for retroreflectivity and illumination; signs may be “flashed” in accordance with flash rates specified in this section. Conditions under which enhancement may be desired include the following:

- Locations with visual clutter due to a combination of existing traffic control signs and adjacent commercial signs
- Locations where the horizontal and/or vertical alignment of the approach roadway in combination with sign placement requirements reduce sign visibility
- Locations where observation indicates low compliance with posted signs

“GRADE CROSSING” (Crossbuck) sign (R15-1) and “NUMBER OF TRACKS” sign (R15-2): The “GRADE CROSSING” sign, commonly identified as the “Crossbuck” consists of a white reflectorized background with the words “RAILROAD CROSSING” in black lettering, as shown in **Figure 9**. Per Section 8B.03 of the MUTCD, the use of the Crossbuck sign at all highway-rail crossings is considered standard practice. The only exception to this requirement is for LRT crossings, where use of the Crossbuck is optional. The MUTCD requires use of the Crossbuck sign, along with the “NUMBER OF TRACKS” sign (where more than one track is present) on each approach to a public highway-rail crossing. The railroad Crossbuck sign and other supplemental signs attached to the Crossbuck mast are usually installed and maintained by the railroad company. (The agency responsible for maintenance of the roadway is normally responsible for advance warning signs and pavement markings.)

Crossbuck signs should be located with respect to the highway pavement or shoulder as discussed above for all signs and should be located with respect to the nearest track in accordance with signal locations as discussed in the next section. Where unusual conditions exist, the placement of Crossbucks should provide the best combination of view and safety clearances as determined by engineering judgment.

Crossbuck Assembly: For passive crossings, the Crossbuck sign is incorporated in a Crossbuck Assembly which includes, the “NUMBER OF TRACKS” sign (required if there is more than one track), and either a “YIELD” or “STOP” sign, with “YIELD” being the default sign subject to engineering study. (Where applicable, each State’s MUTCD supplements to these treatments should be considered.) **Figure 11** and **Figure 12** illustrate the Crossbuck Assembly, showing the different sign selections and orientations that are possible, as shown in Chapter 8B in the MUTCD. **Figure 10** shows the typical layout on the approach to a crossing.

The following standards and/or guidance can be considered for the installation of YIELD or STOP signs at passive crossings per the MUTCD:

- When the YIELD or STOP sign is installed on the same support as the Crossbuck sign, a strip of retroreflective material shall be used on the front and back of the support. The color of the retroreflective strip on the front of the support may be red or white (as per MUTCD Figure 8B-2). The color of the retroreflective strip on the back of the support shall be white. The dimensions and placement of the retroreflective strips should be in conformance with the standards in Section 8B.04.
- When the YIELD or STOP sign is installed on a separate support, a retroreflective strip of red may be installed on the front of the post. The separate Crossbuck support shall have a white strip post front and back (see MUTCD 8B-3).
- When a STOP sign is installed in conjunction with the Crossbuck sign, a stop line should be installed, if appropriate to the roadway surface, to indicate the point behind which vehicles are required to stop, as per MUTCD Section 8B.28.
- When a YIELD sign is used in conjunction with the Crossbuck sign, either a yield line (per MUTCD Section 3B.16) or a stop line (per MUTCD Section 8B.28 and Figure 8B-6) may be installed to indicate the point behind which vehicles are required to yield or stop. When used, the stop line or yield line (such as size, pattern, and location) must be in conformance with provisions in Part 3 of the current edition of MUTCD).

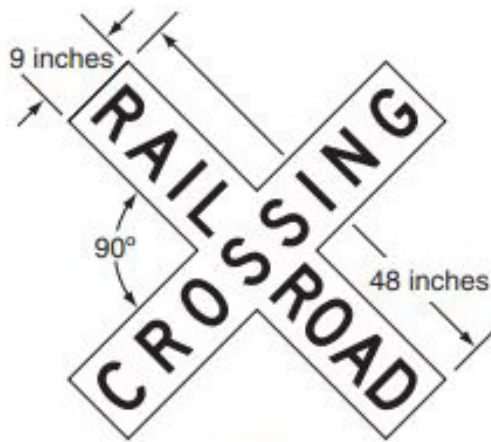

Figure 9. Crossing Sign (Crossbuck)

Source: Manual on Uniform Traffic Control Devices, 2009 Edition, Figure R15-1, Washington, DC, FHWA, 2009.

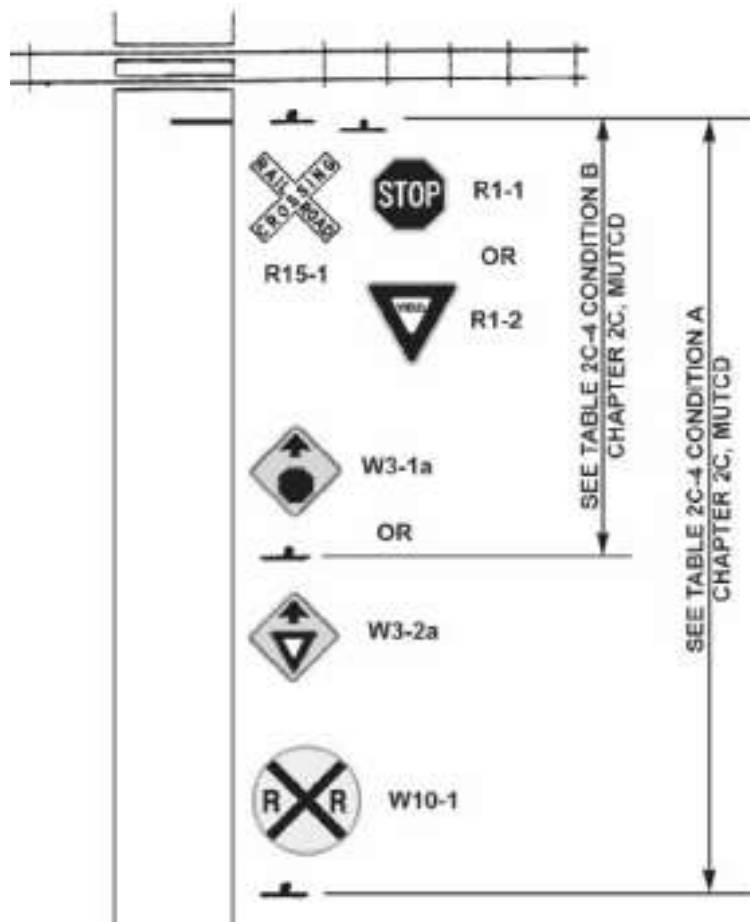
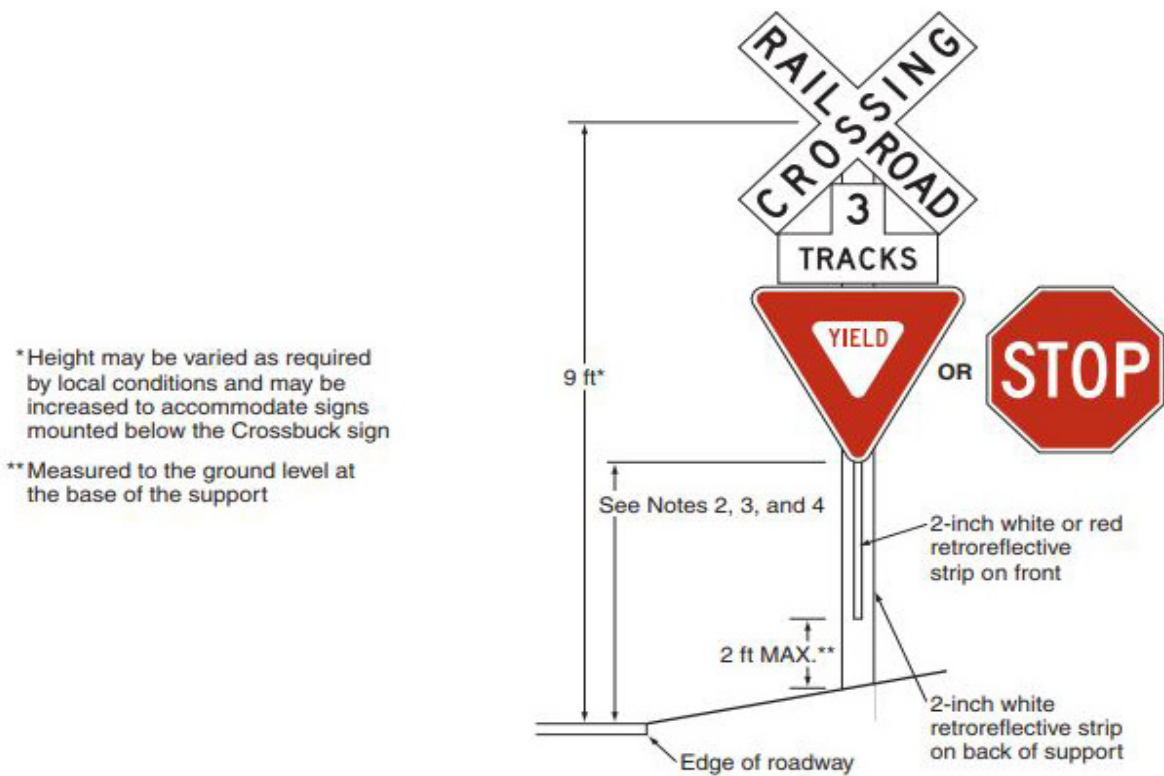

Figure 10. Typical Sign System with STOP or YIELD

Source: Traffic Control Devices Handbook, Washington, DC, ITE, 2013.



Notes:

1. YIELD or STOP signs are used only at passive crossings. A STOP sign is used only if an engineering study determines that it is appropriate for that particular approach.
2. Mounting height shall be at least 4 feet for installations of YIELD or STOP signs on existing Crossbuck sign supports.
3. Mounting height shall be at least 7 feet for new installations in areas with pedestrian movements or parking.

Figure 11. Highway-Rail Crossing (Crossbuck) Sign and STOP or YIELD Sign on Same Post

Source: Manual on Uniform Traffic Control Devices 2009 Edition, Figure 8B-2, Washington, DC, FHWA, 2009.

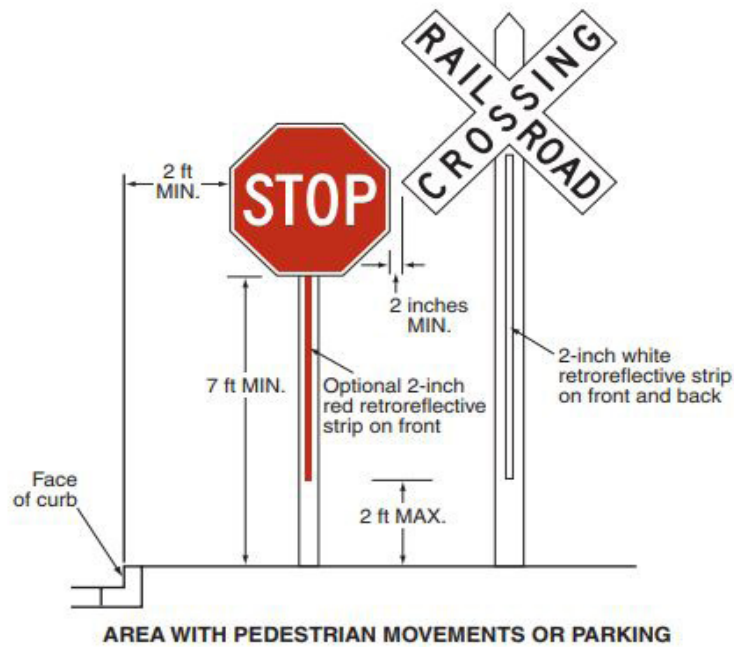
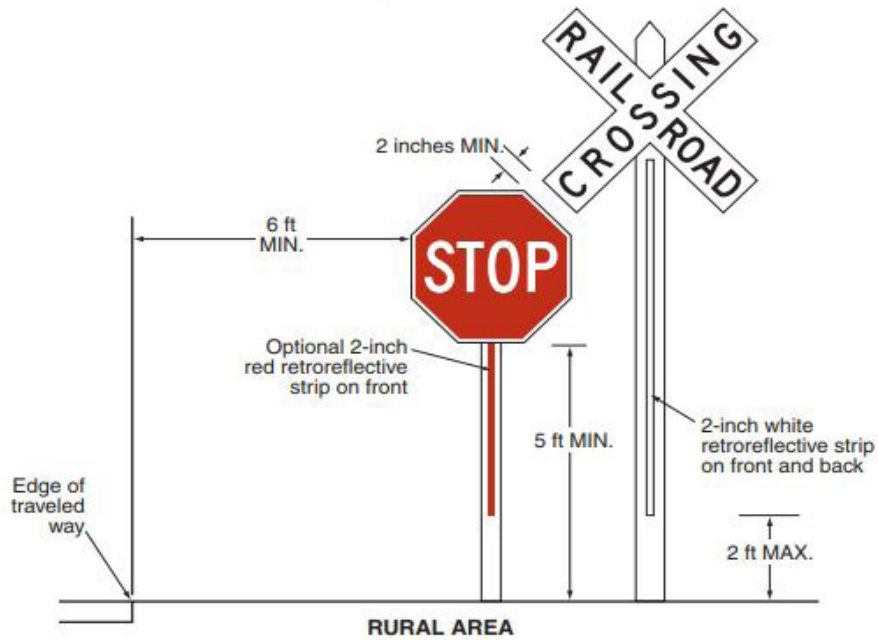

Notes:

1. STOP signs are used only at passive crossings and only if an engineering study determines that it is appropriate for that particular approach.
2. Place the face of the signs in the same plane and place the STOP sign closest to the traveled way. Provide a 2-inch minimum separation between the edge of the Crossbuck sign and the edge of the STOP sign.

Figure 12. Highway-Rail Crossing (Crossbuck) Sign and STOP Sign on Separate Posts

Source: *Manual on Uniform Traffic Control Devices 2009 Edition, Figure 8B-3, STOP sign panel, Washington, DC, FHWA, 2009.*

Emergency Notification sign (I-13): Except for crossings located within railroad yards or port and dock facilities, FRA regulations (49 CFR 234.311) require the installation of Emergency Notification System signs at highway-rail and pathway grade crossings to provide information to road users so that they can notify the railroad company about unsafe conditions or malfunctioning active crossing warning devices. **Figure 13** shows an example of this sign, which is an approved alternate to the Emergency Notification (I-13) sign shown in Figure 8B-5 of the MUTCD.

Advance Warning Signs (W10-1, W10-2, W10-3, W10-4): The round, black, and yellow advance warning sign (W10-1) is located in advance of the crossings and serves to alert the motorist that a crossing is ahead. The advance warning sign has a minimum diameter of 36 inches for conventional roads. Per the MUTCD, the sign is required in advance of all crossings except the following:

- On an approach to a highway-rail crossing from a T-intersection with a parallel highway, if the distance from the edge of the track to the edge of the parallel roadway is less than 100 feet and W10-3 signs are used on both approaches of the parallel highway
- On low-volume, low-speed highways crossing minor spurs or other tracks that are infrequently used and are flagged by train crews
- In business districts where active highway-rail crossing traffic control devices are in use
- Where physical conditions do not permit even a partially effective display of the sign

When the crossing is on a divided highway, it is desirable to place an additional advance warning sign on the left side of each approach. It may also be desirable to place an additional sign on the left side of a highway approach when the highway alignment limits the visibility of signs mounted on the right side.

The distance from the advance warning sign to the track is dependent upon the highway speed, but in no case, should be less than 100 feet in advance of the nearest rail. This distance should allow the driver sufficient time to comprehend and react to the sign's message and to perform any necessary maneuver. (Table 2C-4 in the MUTCD provides recommended placement. Condition A is used for advanced warning sign placement.)

Where a road runs parallel to a railroad and the perpendicular distance between the two is less than 100 feet, there is not enough distance to display the advance warning sign (W10-1). For traffic turning from the parallel road, one of three other warning signs (W10-2, W10-3, and W10-4) can be used when their need has been determined from an engineering study (refer to **Figure 14**).

Storage Space signs (W10-11 & W10-11a): These signs should be used where there is a highway intersection near a crossing and there is not enough storage space to accommodate a design vehicle between the intersection and the dynamic envelope of a train or LRT, subject to an engineering study. **Figure 15** provides an illustrative example of sign placements to address this condition.



Figure 13. Example of Emergency Notification Sign (ENS)

Source: Standard Highway Signs: Including Pavement markings and Standard Alphabet, 2004 Edition, 2012 Supplement, Figure 8B-5. FHWA, Washington, DC, 2012.

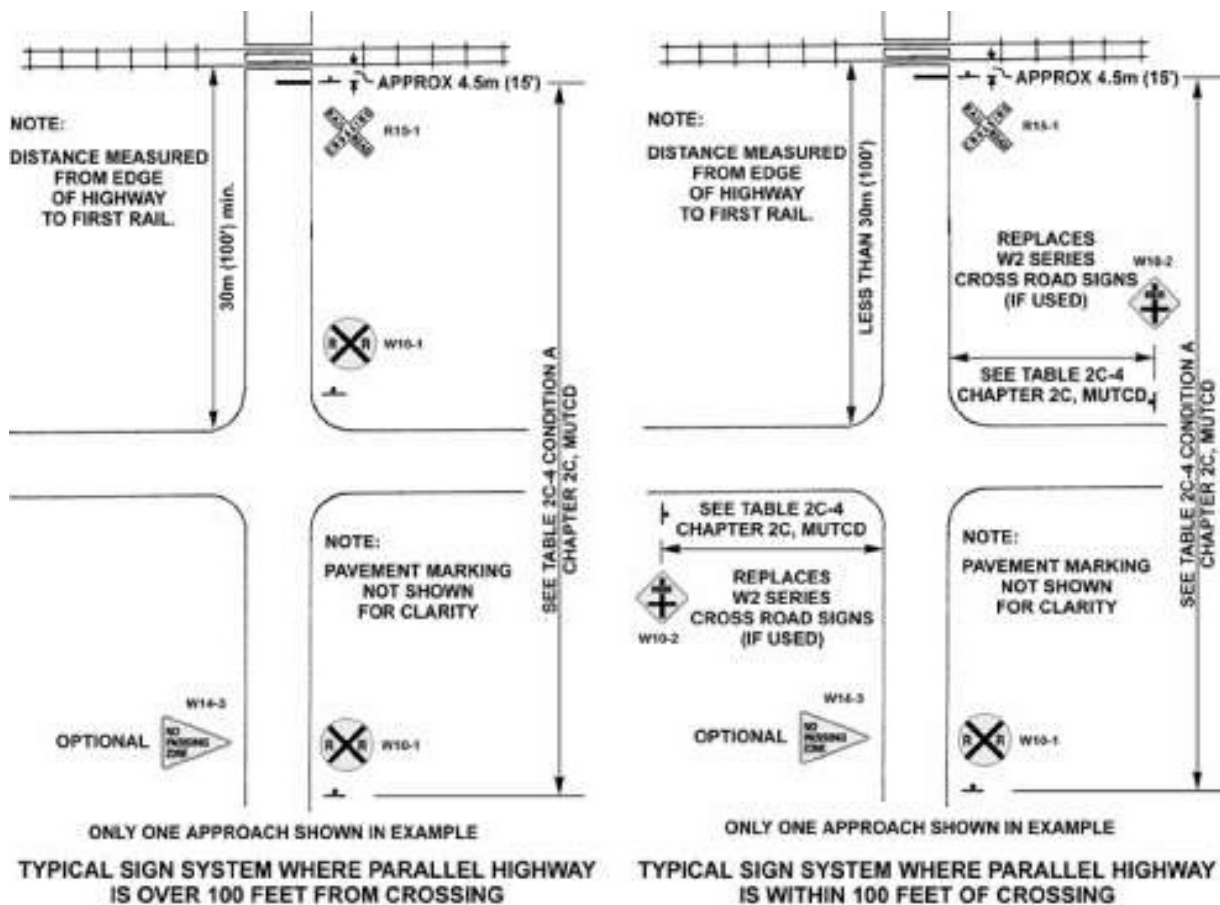

Figure 14. Placement of Advance Warning Signs with Parallel Roadway

Source: Geometric Design Criteria for Highway-Rail Intersections (Grade Crossings), Washington, DC, ITE, 2001.

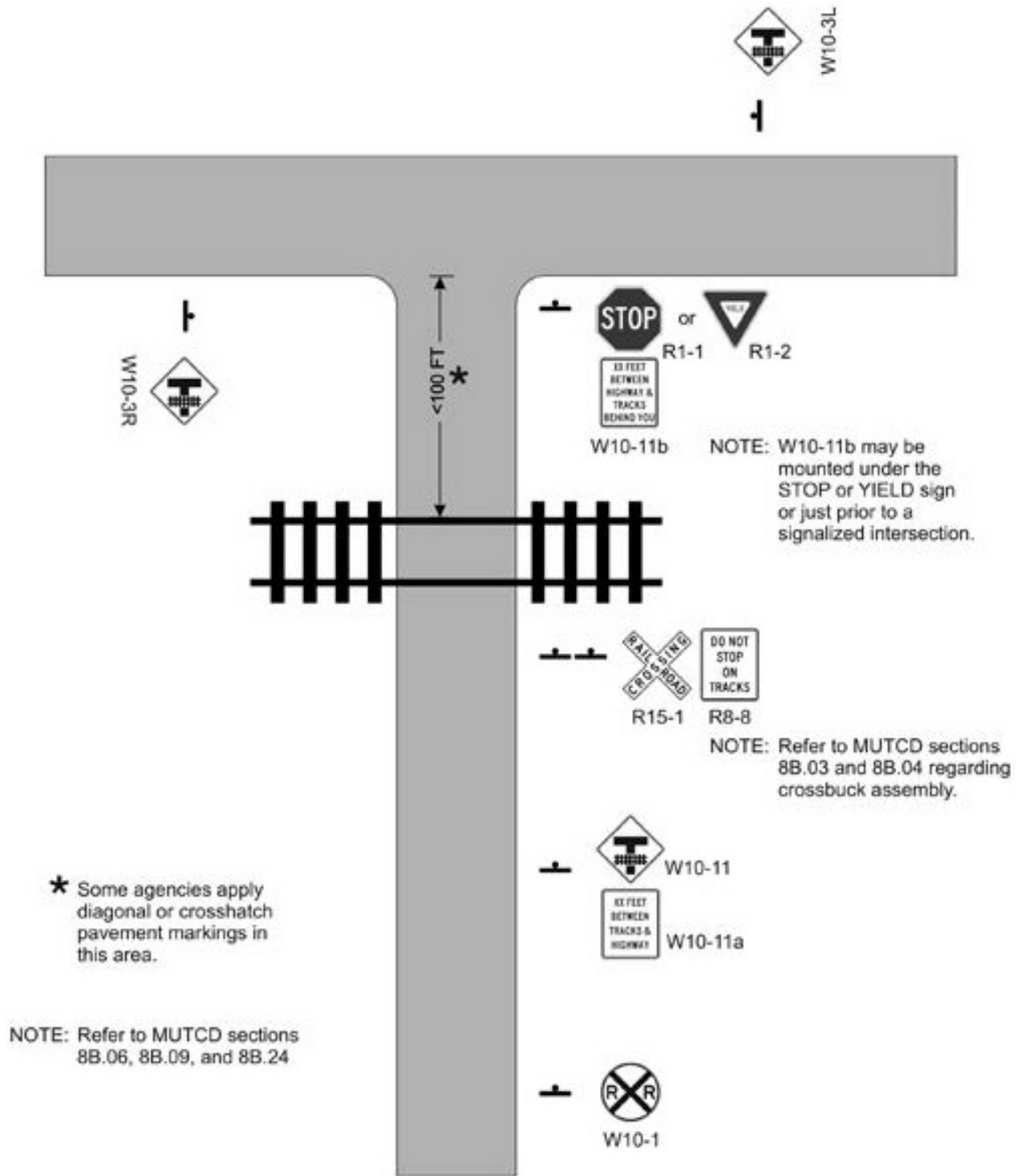

Figure 15. Substandard Clear Storage Distance

Source: Seyfried, R. K., (Ed.), Traffic Control Devices Handbook 2nd Edition, Figure 11-3, Washington, DC, ITE, 2013.

Pavement Markings

Pavement markings are used to supplement the regulatory and warning messages presented by crossing signs and signals. Pavement markings have limitations in that they may be obliterated by snow, may not be visible when wet, and may not be very durable when subjected to heavy traffic.

The MUTCD Section 8B.27 provides that on paved roadways, pavement markings in advance of highway-rail crossings shall consist of an X, the letters RR, a NO PASSING marking on two-lane, two-way highways with centerline markings, and certain transverse lines, as shown in **Figure 16**. Identical markings shall be placed in each approach lane on all paved approaches to crossings where crossing signals or automatic gates are located, and at all other crossings where the prevailing speed of highway traffic is 40 mph or greater. These markings are also to be placed at crossings where engineering studies indicate there is a significant potential conflict between vehicles and trains. These markings may be omitted at minor crossings or in urban areas if an engineering study indicates that other crossing devices provide suitable control. **Figure 16** also shows a placement example of warning signs and pavement markings at highway-rail crossings.

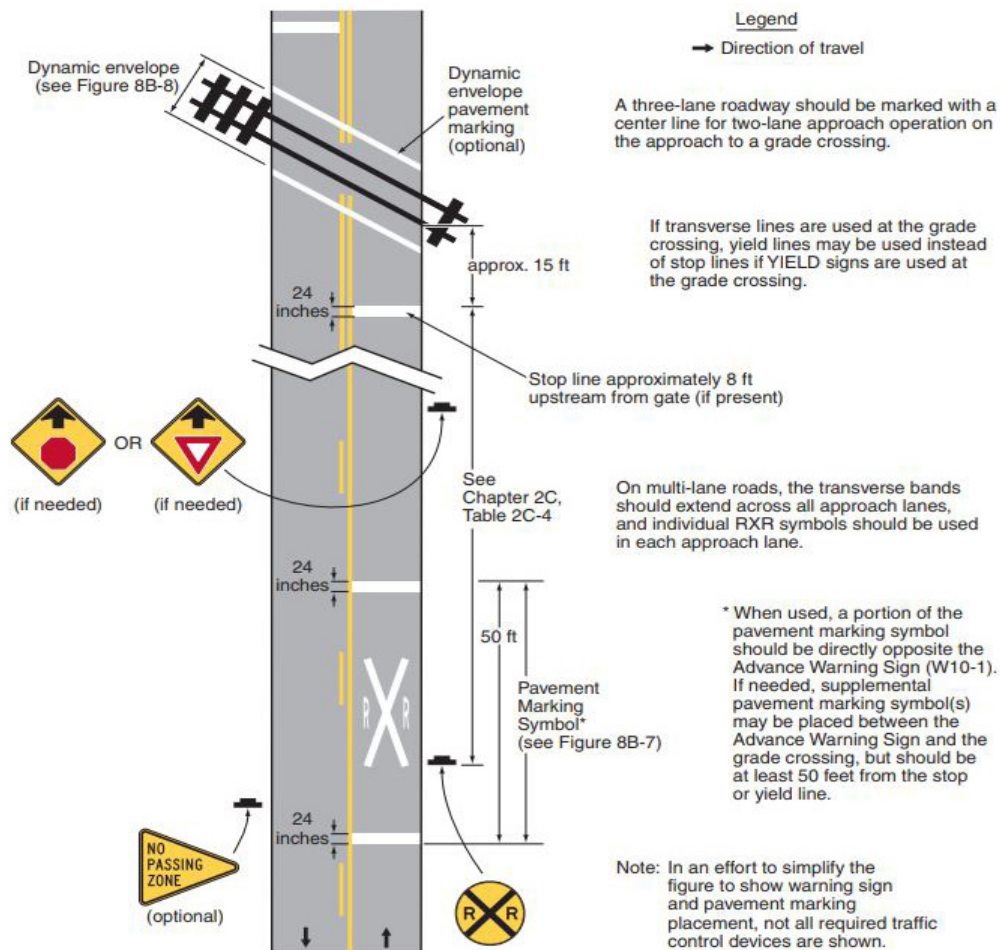

Figure 16. Example of Placement of Warning Signs and Pavement Markings at Highway-Rail Crossings

Source: *Manual on Uniform Traffic Control Devices 2009 Edition, Figure 8B-6, Washington, DC, FHWA, 2009.*

The MUTCD requires that pavement markings specific to crossings shall be retroreflectorized. Other markings are required to comply with MUTCD provisions in Part 3 which requires use of retroreflective materials and/or illumination unless ambient illumination provides adequate night time visibility. Raised pavement markers can be used to supplement pavement markings in advance of crossings. The longitudinal lines, “X” symbol, and stop line can be delineated by raised retroreflective markers to provide improved guidance at night and during periods of rain and fog. Disadvantages of raised pavement markers include the initial cost and the possibility of being damaged or removed by snow plows.

The MUTCD recommends all pavement markings be retroreflectorized white except for the NO PASSING markings that are to be retroreflectorized yellow. By this standard, the stop line is to be 2 feet in width and extend across the approach lanes, and the stop line should be located perpendicular to the highway centerline and approximately 15 feet from the nearest rail. Where automatic gates are installed, the stop line should be located approximately 8 feet in advance of where the gate arm crosses the highway surface.

Exclusion Zone (Keep Clear) Treatments

At locations where queueing on the tracks is of concern due to limited storage space downstream from the crossing, Do Not Block Intersection markings may be used to mark the edges of an intersection area that is in close proximity to a railroad crossing per MUTCD Section 3B.17. Options for the design of Do Not Block Intersection pavement markings are provided in MUTCD Figure 3B-18.

The Illinois DOT design standard uses cross-hatching at pre-signal locations as presented in its design manual and supporting traffic control design standards, as shown in **Figure 17**.

Edge Lines

Widespread use of Global Positioning System (GPS) navigational guidance has been identified as a causative factor in collisions where road users inadvertently turned onto the tracks ahead of a highway intersection at night.⁽²⁷⁾ Carrying edge lines and centerlines across the tracks and careful placement of arrow markings can reduce the likelihood of this type of collision.

Channelizing devices such as tubular markers can be used in conjunction with edge lines at locations where the alignment curves or in rural locations to guide users safely through crossings. Refer to MUTCD Section 3F. **Figure 18** shows a typical treatment.

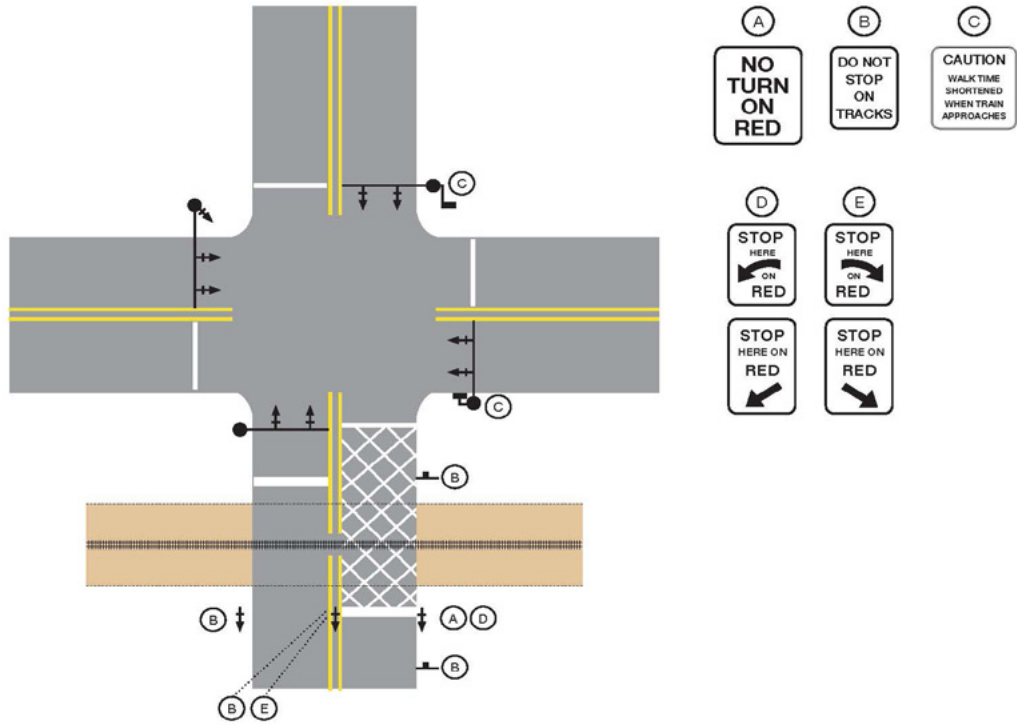

Figure 17. Use of Diagonal Exclusion Zone Striping Shown at Pre-Signal Location

Source: Adapted from Signing and Pavement Marking at Railroad Crossings Memorandum, Typical Supplemental Sign Pavement Marking for Railroad Crossing, IDOT District 1, April 8, 2014.



Figure 18. Illustration of Use of Tubular Markers (Metro North Harlem Subdivision, Green Lane Crossing, Bedford Hills, NY ID 529898H)

Source: Google Earth.

Arrow Markings

Where pavement arrow markings are needed, current practice is to place arrow markings 100 feet or more in advance of the stop line. Practitioners are advised to avoid placement of pavement arrows immediately in advance of the tracks; it may be necessary to place two sets of markings, one between the crossing and the downstream highway and another set well in advance of the crossing, if practicable.

Dynamic Envelope

The dynamic envelope, see **Figure 19**, is the region between and immediately adjacent to the tracks at a crossing where a road user could be struck by a train considering equipment sway. This zone may be delineated with four-inch white pavement markings or other means as described in MUTCD 8B.29.

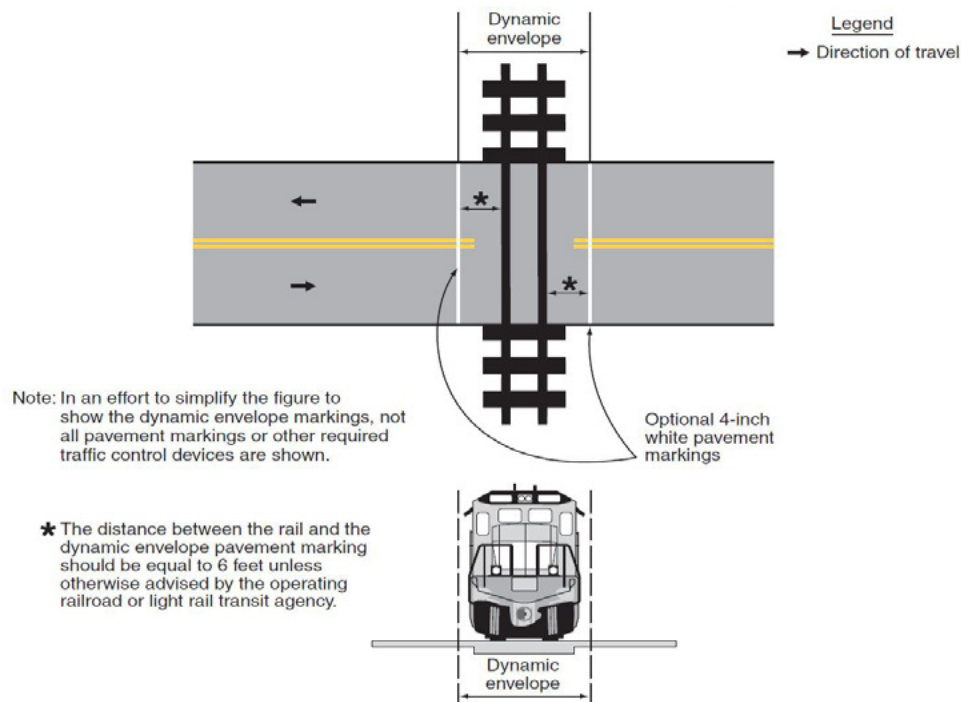

Figure 19. Example of Dynamic Envelopement Pavement Markings at Grade Crossings

Source: Manual on Uniform Traffic Control Devices 2009 Edition, Figure 8B-8, Washington, DC, FHWA, 2009.

The dynamic envelope is specific to the type of rail equipment, which may be operated on the tracks, e.g., the dynamic envelope for freight rail differs from the dynamic envelope for LRT trains. The dynamic envelope is a clearance envelope which considers not only the size and shape of the rail vehicles, but also the overhang and sway of the vehicles moving along the tracks and around curves. The Association of American Railroads (AAR) indicates 10 feet-8 inches as a standard width of the dynamic envelope, so marking the dynamic envelope just beyond 3 feet from the rail is a current practice applicable to freight rail.

ACTIVE TREATMENTS

Overview

Active traffic control devices are those that give visual and audible advance notice of the approach of a train. These include flashing-light signals (both mast-mounted and cantilevered), bells, automatic gates, active advance warning devices, and highway traffic signals. Active devices are typically activated by the passage of a train over a detection circuit in the track, except in those few situations where manual control or manual operation is used (LRT systems typically use loops or contacts because LRT tracks are used as an electrical “ground” to propel trains). Active traffic control devices are usually supplemented with the same signs and pavement markings used for passive control, except that STOP or YIELD signs are not used where active traffic control devices are installed. This section describes the different traffic control devices available for use. Additional guidance on the selection of alternatives can be found in Chapter 3.

Driving tasks at crossings with active traffic control devices are different from those at crossings with passive devices. Passive devices indicate that a crossing is present and that it is the road user’s responsibility to look for an approaching train and take appropriate action. At crossings with active traffic control devices, a motorist is told when a train is approaching or is present at the crossing. It is the motorist’s responsibility to take appropriate action when the devices are activated.

Train Detection and Device Activation

Devices need to be actuated in advance of train arrival to allow road users to clear the track area. A key principle is “warning time”—the amount of advance notice of the arrival of a train. In addition to the time for road users to perceive and react to active warning devices and for pedestrians and vehicles to clear the tracks, active control devices present at a crossing must activate and operate in a logical sequence which may include “preemption” of downstream traffic signals to allow vehicles to clear from the crossing, as well as activation of flashing-light devices and bells followed by descent of the crossing gates, if present.

Active devices are actuated by means of train detection circuitry. Legacy train detection units rely upon conventional electronic components including coils, resistors, and relays. Current train detection is largely solid state driven, but the outputs are taken from relays activated by the solid state circuits. Shown in **Figure 20**, the fundamental concept is use of a railroad circuit which uses the rails as conductors. A voltage is applied across the rails at one end of a detection zone and a relay (or other circuitry) detects the voltage transmitted down the rails. The presence of a solid electrical path, as provided by the wheels and axles of a locomotive or railroad car, shunts (closes) the circuit, which causes the detection relay to trip.

The system is also designed to be fail-safe; that is, any shunt of the circuit, whether by railroad equipment, vandalism, or an “open circuit” (e.g., a broken rail or track connection), will open the relay, which causes the crossing signals to be activated.

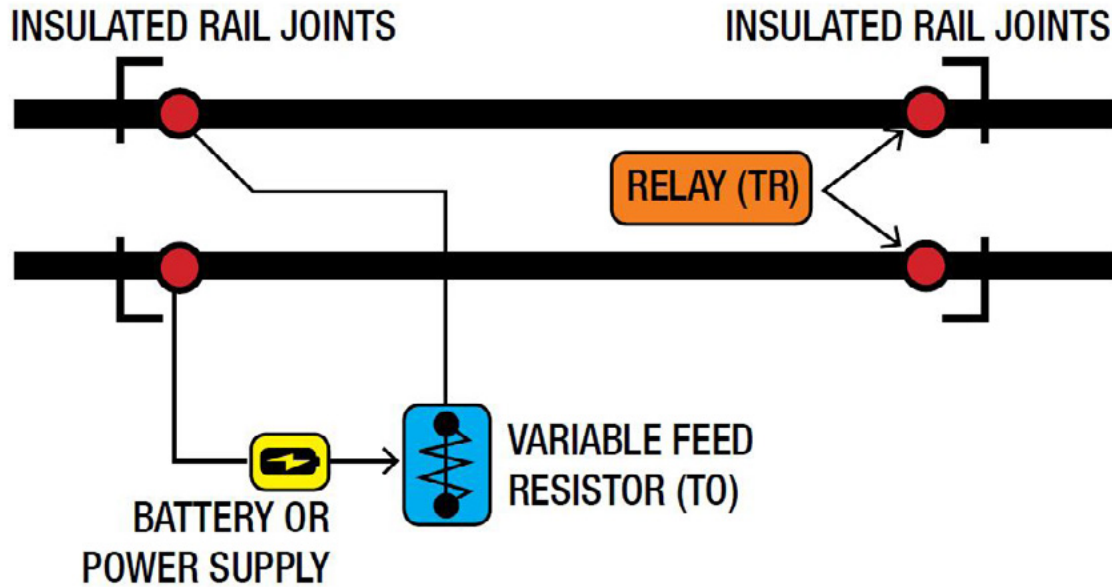

Figure 20. DC Track Circuit

Source: Adapted from Minor Railways Section Guideline on Train Detection DC Track Circuits, Figure 1, Institute of Railway Signal Engineers, 2014.

Standard highway traffic signals always display a green, yellow, or red light except when power has failed and the signals are dark. Active crossing warning devices, however, usually incorporate some “fail-safe” design principles. In other words, the crossing warning system is designed to give an indication of an approaching train whenever the system fails. Crossing signals are normally dark unless a train is approaching or occupying the crossing, so there is no indication to the road user when power has failed. Therefore, crossing control systems include stand-by battery power should commercial power be terminated for any reason. Solar energy may be used to charge storage batteries to power signals at crossings in remote locations.

Factors that may be considered in the design and installation of a train detection system include the following:

- Existing rail and ballast conditions
- Volume, speed, and type of highway and rail traffic
- Other train detection circuits that may be used on the same pair of rails for the regulation of train movements
- Train propulsion currents on electrified lines
- Track switch locations within the approach warning distances for a crossing
- Train detection circuits used for other crossings within the approaches (overlapping)
- Number of tracks
- Warning time and system credibility

Constant Warning Time Track Circuit

Where constant warning time is provided, the track circuitry equipment has the capability to sense a train in the approach section, measure its speed and distance from the crossing, and activate the warning equipment to provide the selected minimum warning time. Thus, regardless of train speed, a uniform warning time is provided. If a train stops prior to reaching the crossing or is moving away from the crossing, the warning devices are deactivated to allow highway traffic to move over the crossing. With constant warning time equipment, trains beyond 700 feet can move or switch on the approaches without reaching the crossing, and depending on their speed, not cause the crossing warning devices to be activated, thus eliminating unnecessary delays to highway traffic.

Warning Time Considerations

Train detection systems are designed to provide the minimum warning time for a crossing. The MUTCD and FRA regulations (49 CFR 234.225) require that the system provide for a minimum of 20 seconds of warning time. When determining if the minimum 20 seconds of warning time should be increased, some factors that should be considered include but are not limited to the following:

- Track clearance distances due to multiple tracks and/or angled crossings (add 1 second for each 10 feet of added crossing length in excess of 35 feet).
- The crossing is located within proximity of a highway intersection controlled by STOP signs where vehicles have a tendency of stopping on the crossing.
- The crossing is regularly used by long tractor-trailer vehicles.
- The crossing is regularly used by vehicles required to make mandatory stops before proceeding over the crossing (such as school buses and hazardous materials vehicles).
- The crossing's active traffic control devices are interconnected with other highway traffic signal systems.
- It is necessary to provide at least 5 seconds between the time the approach lane gates to the crossing are fully lowered and when the train reaches the crossing (49 CFR 234.223).
- The crossing is regularly used by pedestrians and non-motorized components.
- The crossing and approaches are not level.
- Additional warning time is needed to accommodate a four-quadrant gate system.
- Other factors regarding crossing location as appropriate.

It should be noted that even when constant warning devices are used, the calculated arrival time of the train at the crossing is based on the instantaneous speed of the train as it enters the crossing circuit. Once the calculation is made, changes in the train speed will change the train arrival time at the crossing and, correspondingly, reduce (or increase) the elapsed warning time at the crossing. This factor must be considered at a crossing interconnected to a nearby highway traffic signal utilizing either a simultaneous or advance preemption sequence.

Excessive warning time has been determined to be a contributing factor in some collisions. Motorists who are stopped at an activated flashing-light signal and see no train approaching or see a distant train moving very slowly might ignore the warning of the signals and cross the tracks. A collision could result as the signals may have been activated by a high-speed passenger train just out of sight, not by the slower freight. If motorists are successful in clearing the tracks, they may assume that other crossings have excessive warning time. When they encounter a crossing with minimum warning time, they may ignore the signals, move onto the crossing, and become involved in a collision. This credibility problem is strengthened if motorists continue to successfully pass through activated signals with excessive warning time.

Reasonable and consistent warning times reinforce system credibility. Unreasonable or inconsistent warning times may encourage undesirable driver behavior. Research has shown that when warning times exceed 40–50 seconds, drivers will accept shorter clearance times at flashing-lights and a significant number will attempt to drive around gates.⁽²⁸⁾ Although mandated maximum warning times do not yet exist, efforts should be made to ensure that traffic interruptions are reasonable and consistent without compromising the intended safety function of an active control device system's design.

Excessive warning times are associated with a permanent reduction in the class of track and/or train speeds without a concomitant change in the track circuitry or without constant warning time equipment. When not using constant warning train detection systems, track approach circuits should be adjusted accordingly when train speeds are permanently reduced. Another frequent cause of excessive warning times at crossings without constant warning time equipment is variable-speed trains, such as intercity passenger trains or fast commuter trains interspersed with slower freight trains.

A major factor affecting system credibility is an unusual number of false activations at active crossings. Every effort should be made to minimize false activations through improvements in track circuitry, train detection equipment, and maintenance practices. A timely response to a system malfunction coupled with repairs made without undue delay can reduce credibility issues. Health monitoring systems capable of reporting to dispatch can improve response times.

Design information about railroad interconnection circuits and approach length calculations can be found in the AREMA *Communications and Signals Manual*, Part 3.1.10, "Recommended Functional/Operating Guidelines for Interconnection Between Highway Traffic Signals and Highway-Rail Grade Crossing Warning Systems," and Part 3.3.10, "Recommended Instructions for Determining Warning Time and Calculating Minimum Approach Distance for Highway-Rail Grade Crossing Warning Systems."⁽²⁹⁾

FLASHING-LIGHT SIGNALS

The fundamental active warning device is the flashing-light signal, refer to **Figure 21**, which shows the unit combined with an automatic crossing gate. Flashing-light signals consist of two light units that flash alternately at a rate of 35 to 65 times per minute. The signal lens is red and comes in a variety of designs that direct the light toward the motorist. The lamp consists of a low-wattage bulb (legacy units) or LED assembly (current practice) used to ensure operation on stand-by battery power should commercial power fail.

The LED units used in new installations offer many advantages over conventional incandescent lamps including the following:

- Higher visibility at greater distances for in-line observations
- Greater visibility on angles
- Wider beam pattern and therefore easier beam alignment
- Pure red signal with fast on/off transition, which improves conspicuity
- Lower current consumption at nominal voltage, thereby suitable for solar-powered applications
- Longer life expectancy



Figure 21. Illustrative Example Showing Cantilever with Flashing-Light Devices

Source: Brent Ogden.

Key MUTCD requirements (refer to Part 8C.02) include the following:

- If used, the flashing-light signal assembly on the side of the highway shall include a standard Crossbuck (R15-1) sign, and, where there exists more than one track, a supplemental Number of Tracks (R15-2P) plaque, all of which indicate to motorists, bicyclists, and pedestrians the location of a crossing.
- The flashing-light signal shall display toward approaching highway traffic two red lights mounted in a horizontal line flashing alternately.
- Flashing-light signals shall be placed to the right of approaching highway traffic on all highway approaches to a crossing. They shall be located laterally with respect to the highway in compliance with MUTCD Figure 8C-1 except where such location would adversely affect signal visibility.
- If used at a crossing with highway traffic in both directions, back-to-back pairs of lights shall be placed on each side of the tracks. On multi-lane one-way streets and divided highways, flashing-light signals shall be placed on the approach side of the crossing on both sides of the roadway or shall be placed above the highway.
- MUTCD requires 12-inch lenses for all new installations excepting signals controlling pedestrian movements; however, where 8-inch units are already in place they may be retained for the remainder of their useful service life.

Other MUTCD guidance includes the following:

- At highway-rail crossings, bells or other audible warning devices may be included in the assembly as determined by a Diagnostic Team and may be operated in conjunction with the flashing-lights to provide additional warning for pedestrians, bicyclists, and/or other non-motorized road users.
- If determined by a Diagnostic Team, flashing-light signals may be installed on overhead structures or cantilevered supports, as shown in **Figure 21**, where needed for additional emphasis, or for better visibility to approaching traffic, particularly along multi-lane approaches or highways with profile restrictions. If it is determined by a Diagnostic Team that one set of flashing-lights on the cantilever arm is not sufficiently visible to road users, one or more additional sets of flashing-lights may be mounted on the supporting post and/or on the cantilever arm.

Current practice is to provide one flashing-light signal directed at each approach lane which may require use of an overhead cantilever and to provide supplemental flashing-light units aimed at frontage road approaches, as discussed below.

Proper alignment of the light is essential. The following guidance on aiming lights was developed originally for highly directional 12-volt bulbs and reflectors. Current LED equipment, however, is more tolerant on the precision of aiming. Nevertheless, the aiming principles described should be followed. The flashing-light unit on the right-hand side of the highway is usually aligned to cover a distance far from the crossing. The light units mounted on the back of the signals on the opposing approach and, thus, on the left, are usually aligned to cover the near approach to the crossing. **Figure 22** shows typical alignment patterns for a two-lane, two-way highway and for a multilane highway.

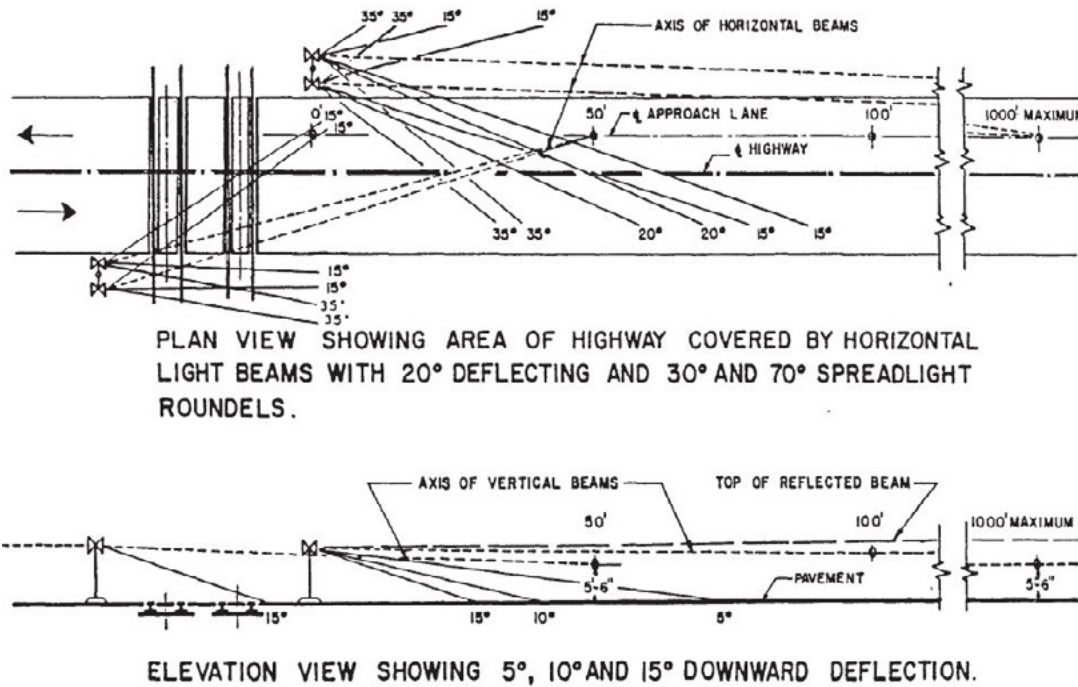

Figure 22. Typical Alignment Pattern for Flashing-Light Signals with 30–15 Degree Roundel, Two-Lane, Two-Way Roadway

Source: Communications & Signals Manual, Figure 335-1, Lanham, MD, AREMA, 2018.

Cantilevered Flashing-Light Signals

Flashing-light signals are post-mounted, but where improved visibility to approaching traffic is required, cantilevered flashing-light signals are used. Cantilevered flashing-lights may be appropriate when any of the following conditions exist:

- Multilane highways (two or more lanes in one direction)
- Highways with paved shoulders or a parking lane that would require a post-mounted light to be more than 10 feet from the edge of the travel lane
- Roadside foliage obstructing the view of post-mounted flashing-light signals
- A line of roadside obstacles such as utility poles (when minor lateral adjustment of the poles would not solve the problem)
- Distracting backgrounds such as an excessive number of neon signs (conversely, cantilevered flashing-lights should not distract from nearby highway traffic signals)
- Horizontal or vertical curves at locations where the extension of flashing-lights over the traffic lane will provide sufficient visibility for the required stopping sight distance

A typical installation consists of one pair of cantilevered lights on each highway approach, supplemented with a pair of lights mounted on the supporting mast. However, two or more pairs of cantilevered flashing-lights may be desirable for multilane approaches, as determined by an engineering study. The cantilevered lights can be placed over each lane so that the lights are mutually visible from adjacent driving lanes.

Most current installations utilize walkout cantilevers. The inclusion of a ladder and access walkway allows for easier maintenance with less impact to highway traffic. Standard cantilevers for mounting flashing-lights are made with arm lengths up to 40 feet. Where cantilever arm length is more than 35 feet, a bridge structure is preferred.

Supplemental Flashing-Light Signals

Additional pairs of light units, sometimes referred to as “side lights” may also be installed for side roads intersecting the approach highway near the crossing or for horizontal curves.

Figure 23 shows the use of multiple pairs of lights to cover a horizontal curve to the left on the approach highway. A horizontal curve to the right may be covered by placing another roadside flashing-light unit on the opposite side of the highway, as shown in **Figure 24**. **Figure 25** shows the use of side lights to provide warning to road users approaching from frontage roadways parallel the railroad. Mounting of angled side light units should maintain the 30-inch spacing indicated in MUTCD Figure 8C-1 from the vantage point of the road user.

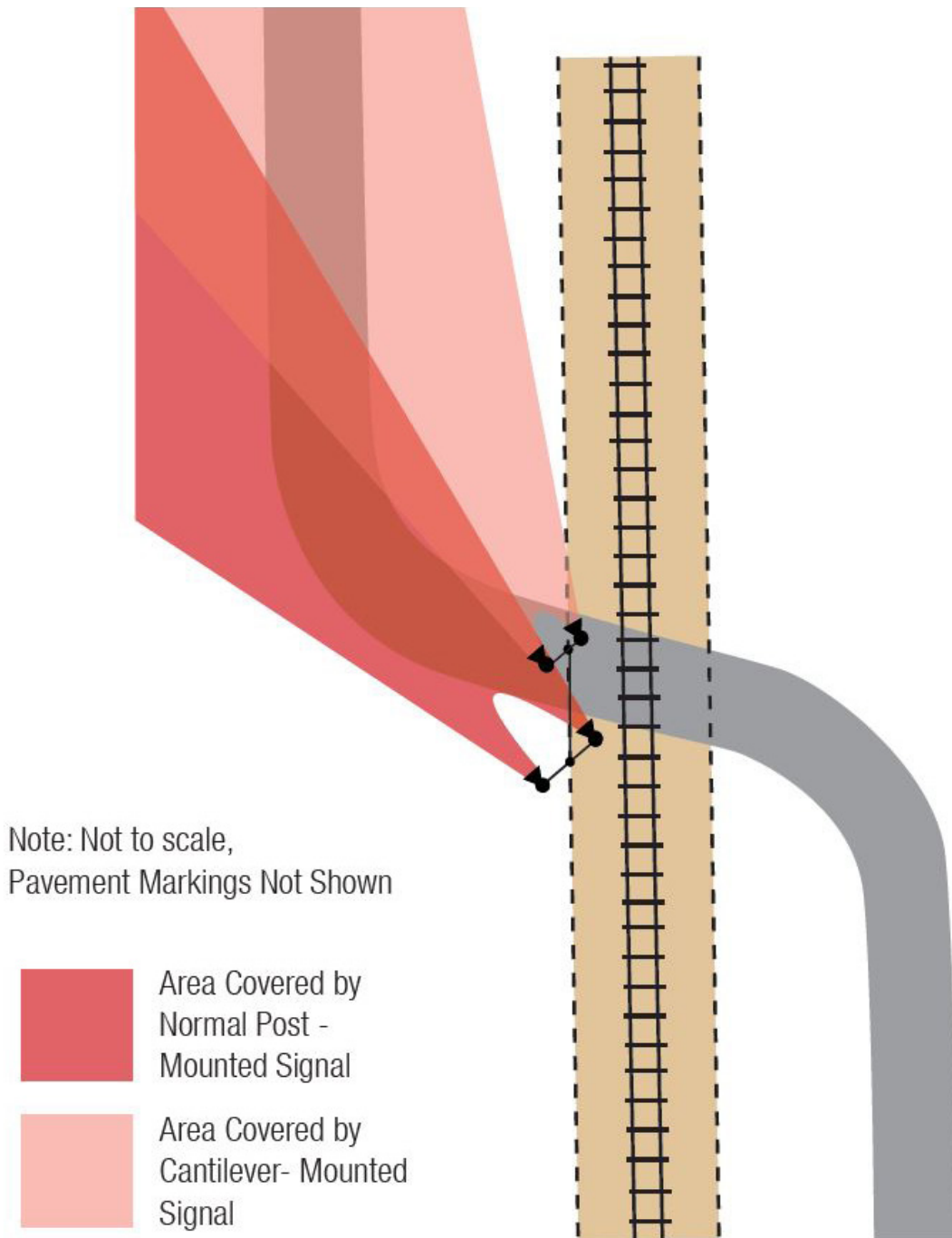

Figure 23. Use of Multiple Flashing-Light Signals for Adequate Visibility Horizontal Curve to the Left

Source: Institute of Transportation Engineers.

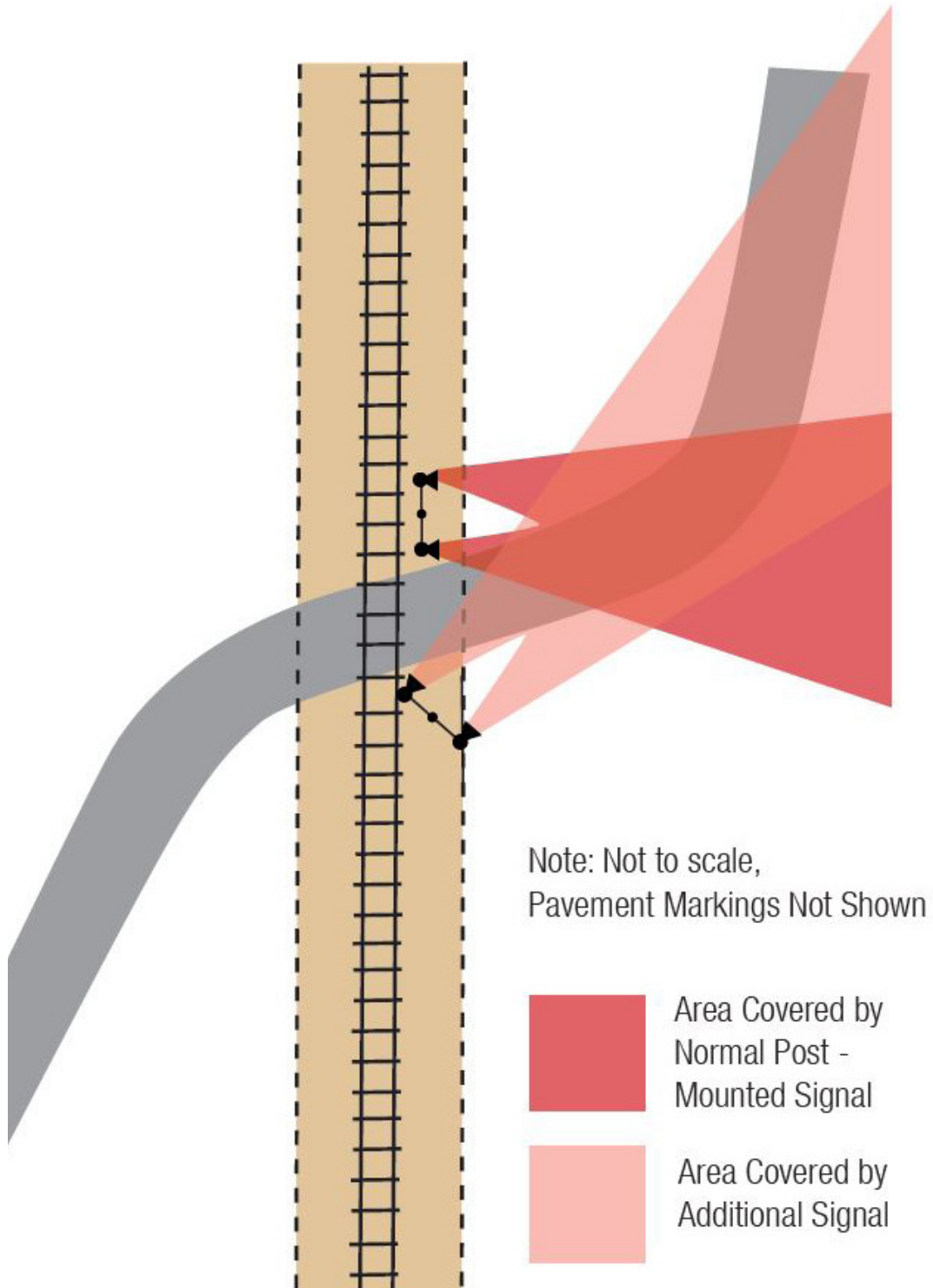

Figure 24. Use of Multiple Flashing-Light Signals for Adequate Visibility Horizontal Curve to the Right

Source: Institute of Transportation Engineers.

Note: Not to scale,
Pavement Markings Not Shown

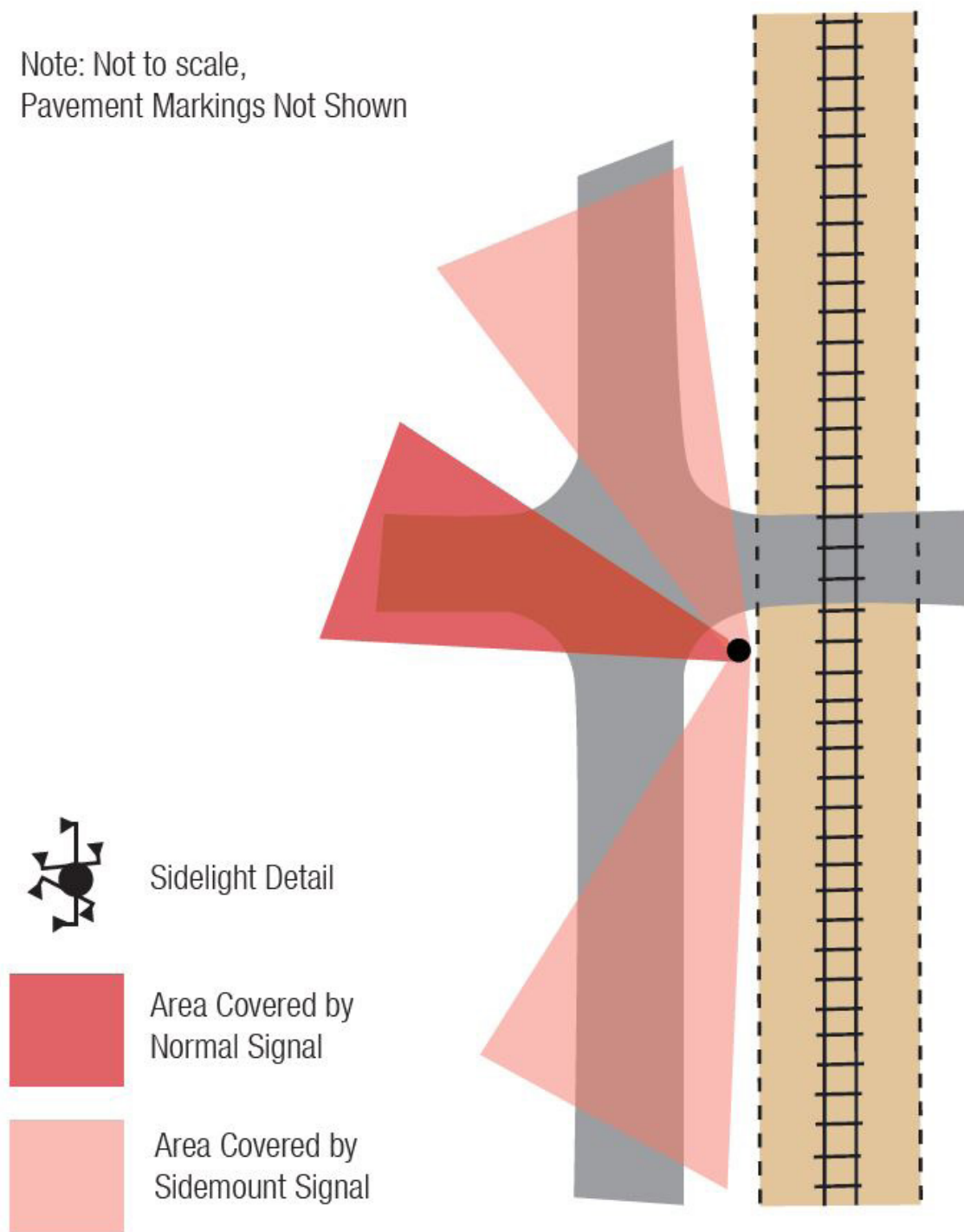

Figure 25. Use of Sidelights for Frontage Roads

Source: Institute of Transportation Engineers.

AUDIBLE WARNING

A crossing bell is an audible warning device used to supplement other active traffic control devices. A bell is most effective as a warning to pedestrians and bicyclists.

When used, the bell is usually mounted on top of one of the signal support masts. Alternatively, the bell may be separately mounted on an arm attached to the signal mast. The bell is usually activated whenever the flashing-light signals are operating. Bell circuitry may be designed so that the bell stops ringing when the lead end of the train reaches the crossing. When gates are used, the bell may be silenced when the gate arms descend to within 10 degrees of the horizontal position. Silencing the bell when the train reaches the crossing or when the gates are down may be desired to accommodate residents of suburban areas.

Crossing bell specifications indicate a range of a minimum of 75 dB(A) and a maximum of 105 dB(A). AREMA specifications detail how these measurements are taken, including the following:

- Bell should operate between 100 and 325 strokes per minute.
- Electronic bells should emulate the sound of electro-mechanical bells.
- Practitioners should decide as to whether one audible device is adequate to serve the entire crossing or if a second bell should be added at large crossings.

In addition to the audible device(s) provided at the crossing, FRA requires the sounding of locomotive mounted horns in advance of crossing occupancy by a train. [Refer to “Requirement to Sound the Locomotive Horn” within the “Quiet Zones” topic in Chapter 6](#) for additional guidance.

Wayside Horn

Another form of audible warning is the wayside horn. The wayside horn system consists of a horn or series of horns located at a public highway-rail crossing and directed at oncoming motorists. (Refer to **Figure 26** which shows a typical installation using two horns to alert road users approaching from each direction.) The system is designed on fail-safe principles and provides a means to verify sound output. The wayside horn system does the following:

- Simulates the sound and pattern of a train horn
- Provides similar response from road users
- Minimizes the audible footprint in comparison to a locomotive horn sounding when approaching a highway-rail crossing



Figure 26. Automated Wayside Horn

Source: Campbell Technology Corporation.

A wayside horn system can be used as an adjunct to train-activated crossing warning systems to provide audible warning of an approaching train for traffic on each approach to the highway-rail crossing. Wayside horns provide a directional sound which is aimed at approaching roadway users and pedestrians while minimizing the noise impact to properties adjacent to the railroad beyond the immediate crossing zone. (The wayside horn system does not need to be directed toward approaching roadway users on roadways adjacent to the railroad if a STOP sign or traffic signal control device controls roadway traffic.)

When a wayside horn system is used at highway-rail crossings where the locomotive-mounted horn is not sounded, the highway-rail crossings should be equipped with flashing-lights and gates, power-out indicator, and constant warning circuitry—where practical. In such instances, the wayside horn should also provide a “confirmation” indication to the locomotive engineer; in the absence of a confirmation signal, the engineer would need to activate the locomotive-mounted horn.

The wayside horn system simulates a train horn and sounds at a minimum of 15 seconds prior to the train’s arrival at the highway-rail crossing, until the lead locomotive has traversed the crossing. Where multiple tracks are present, the wayside horn system is immediately reactivated when another train is detected before the previous train clears the crossing. Wayside horn systems should include a 3- to 5-second delay after activation of flashing-lights signals before sounding.

Section 8C.07 of the MUTCD discusses the installation of wayside horn systems in compliance with 49 CFR 222.⁽⁵⁾ These systems provide audible warning directed toward the road users at a highway-rail or highway-LRT crossing, or at a pathway crossing.

Additional information regarding Quiet Zones can be found in this *Handbook* in the section regarding Quiet Zones.

AUTOMATIC GATES

An automatic gate serves as a barrier across the highway when a train is approaching or occupying the crossing. The gate is reflectorized with vertical red and white stripes. To enhance visibility during darkness, three red lights are placed on the gate arm. The light nearest to the tip remains steadily on; the other two flash alternately. The gate is combined with a standard flashing-light signal that provides additional warning before the arm starts to descend, while the gate arm is across the highway, and until the gate arm ascends to clearance. The gate mechanism is either supported on the same post with the flashing-light signal or separately mounted on a pedestal adjacent to the flashing-light signal post. Additional guidance regarding these devices can be found in Chapter 3.

In a normal sequence of operation, the flashing-light signals and the lights on the gate arm in its normal upright position are activated upon the detection or approach of a train. The MUTCD standard in Section 8C.04 requires that the gate arm should start its downward motion not less than 3 seconds after the signal lights start to operate, should reach its horizontal position before the arrival of the train, and should remain in that position while the train occupies the crossing. When the train clears the crossing, and no other train is approaching, the gate arm should ascend to its upright position normally in no more than 12 seconds, after which the flashing-lights and the lights on the gate arm should cease operation. In the design of individual installations, accommodations for large and/or slow-moving highway vehicles (regarding timing the operation of the gate arm) should be considered.

Section 9.6 of the California Public Utilities Commission (CPUC) General Order 75-D requires that, when the gates are fully lowered, the gap between the ends of two complementary gates must be less than two feet. This CPUC General Order also requires that, if there is a median, centerline striping, or other form of channelization installed, the gap between the gate end and the channelization device must be within one foot.” Some railroads request reconfiguration of the crossing when gate arm lengths would exceed 32 feet and it may be necessary to place gate assemblies in the median to cover the approach highway, in which case a 9-foot wide median should be used to provide adequate clearance. In these cases, crash cushions or other safety barriers may be desirable. Under no circumstances should signals or gate assemblies be placed in an unprotected painted median.

Conversely, some railroads would prefer longer gate arms rather than a gate mechanism in the median. When no train is approaching or occupying the crossing, the gate arm is held in a vertical position and the minimum clearance from the face of the vertical curb to the nearest part of the gate arm or signal is 2 feet, for 17 feet above the highway. Where there is no curb, a minimum horizontal clearance of 2 feet from the edge of a paved or surfaced shoulder is required per MUTCD 8C.01, with a minimum clearance of 6 feet from the edge of the traveled highway. Where there is no curb or shoulder, the minimum horizontal clearance from the traveled way is 6 feet. Where flashing-lights or gates are located in the median, additional width may be required to provide the minimum clearances for the counterweight support. It should be noted that gate arms have a maximum standard length of 32–38 feet, depending upon the railroad.

The lateral location of flashing light and gate assemblies should provide adequate clearance from the track as well as space for construction of the foundations. (The area for the foundation and excavation should be analyzed to determine the effect on sidewalks, utility facilities, and drainage.) **Figure 27** indicates current standards: It should be noted that commercially available components may encroach on the desired 10-foot clearance between the face of the device and center of rail, therefore a 12-foot setback may be inadequate. For these reasons, some railroads require a 15-foot minimum clearance.

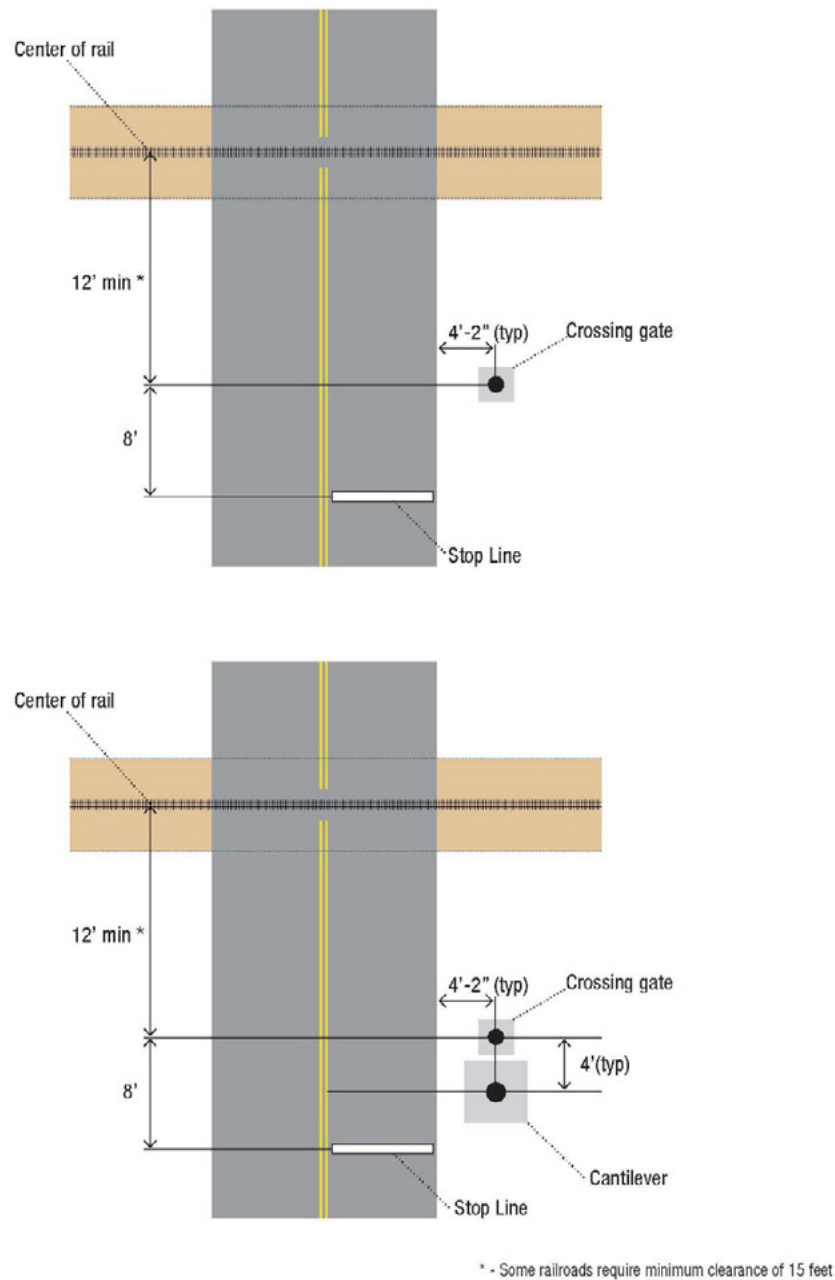

Figure 27. Typical Location of Signal Devices

Source: Institute of Transportation Engineers.

If it is necessary to locate the supporting post in a potentially hazardous position to ensure adequate visibility, some type of safety barrier should be considered. These are discussed in a later section.

Large multilane intersections and intersections with unusual configurations should be carefully studied to determine the appropriate layout of crossing gate locations. For such conditions, gate arm requirements may become a principal factor in the layout of the intersection geometry and channelization from the outset. The crossing gate (and, therefore, traffic control) treatment should be an integral part of the design of an intersection, not an afterthought.

Discussion on pedestrian treatments can be found in the Pedestrian Treatments section of this document.

It is desirable to place crossing gates perpendicular to the direction of travel on the approach roadway. **Figure 28** provides an illustrative example for an orthogonal crossing. The crossing gate mast should be 15 feet from the center of rail; where necessary, this distance can be reduced with concurrence from the railroad provided a minimum distance of 10 feet from the center of rail to the face of any part of the device is maintained. The crossing gate arm typically has a maximum length of 32 feet; if allowed by the railroad, longer gate arms may be used. At locations where the crossing is at a skew angle, the crossing gates need to be set back to be installed perpendicular to the roadway while meeting the required minimum 12-foot distance from the center of rail (refer to **Figure 29** and **Figure 30** for obtuse and acute angled crossings, respectively). At locations where there is a frontage road intersection close to the crossing, it may not be possible to achieve a mounting perpendicular to the approach roadway and angling the crossing gates may be required as shown in **Figure 31**. Angled crossing gates reduce the size of the zone between the crossing gate and rail, and may be helpful to prevent vehicles from driving around the entry gates. Current retroreflective materials are activated over a very wide angle and should be visible at night; rotating the gates minimizes the area behind the gate and results in a shorter pedestrian zone behind the gates.

Multi-lane highways typically require use of median-mounted crossing gates. A median-mounted gate may satisfy the criteria to have one set of flashing-light devices aimed at each approach lane. If there are three or more approach lanes, a cantilever is usually required. Examples showing use of medians with median gates and with the cantilever mounted upstream and downstream from the crossing gates are shown in **Figure 32** and **Figure 33**, respectively.

[Refer to the subsequent topic Use of Channelization with Gates](#) for more information on median treatments.

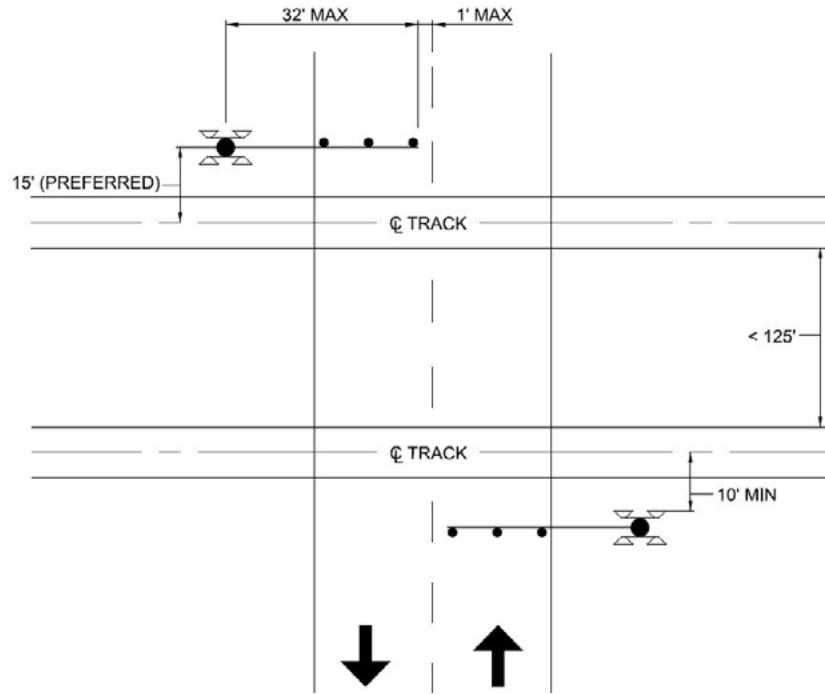

Figure 28. Typical Crossing Gate Placement at 2-Lane Orthogonal Crossing

Source: Institute of Transportation Engineers.

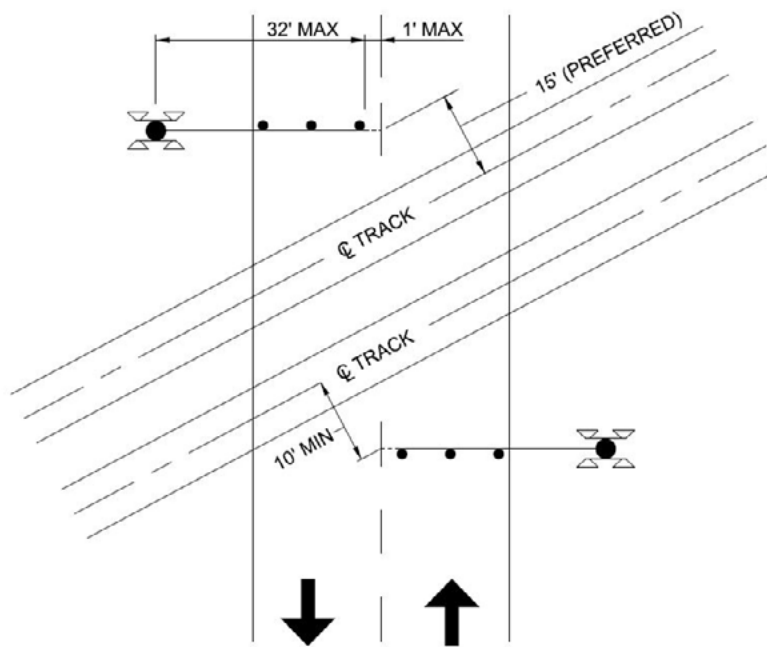

Figure 29. Typical Crossing Gate Placement at Obtuse Angled Crossing

Source: Institute of Transportation Engineers.

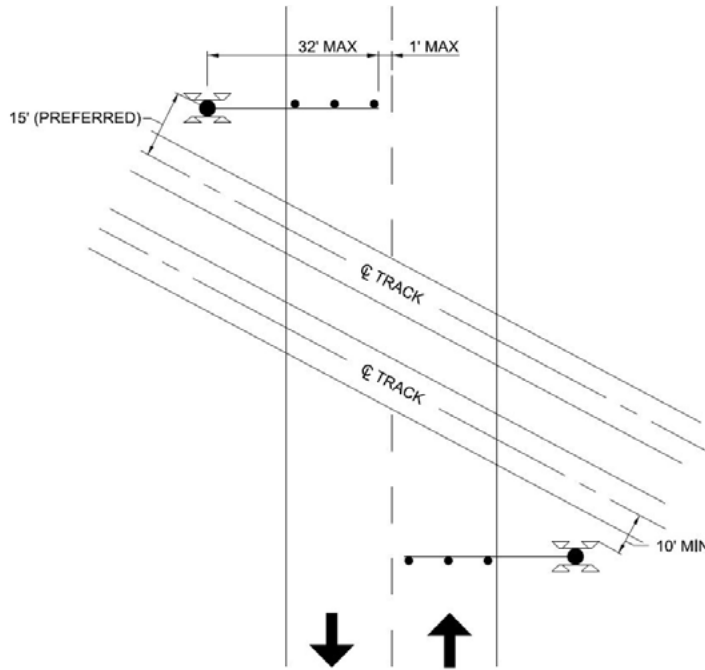

Figure 30. Typical Crossing Gate Placement at Acute Angled Crossing

Source: Institute of Transportation Engineers.

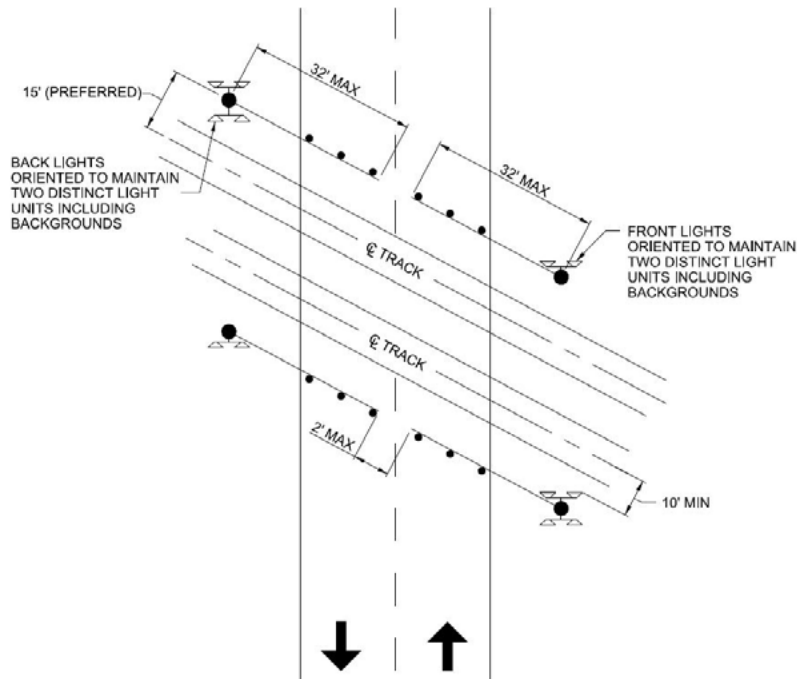

Figure 31. Alternate Crossing Gate Placement at Acute Angled Crossing (Shown with Exit Gates)

Source: Institute of Transportation Engineers.

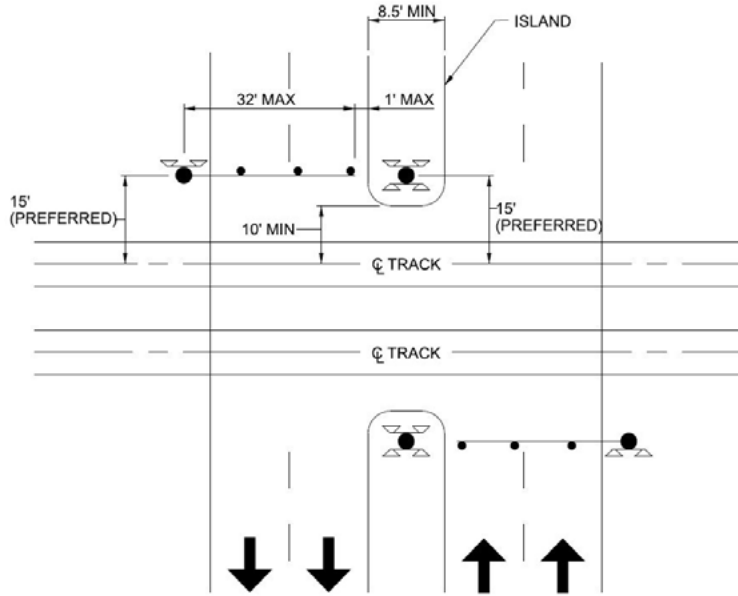
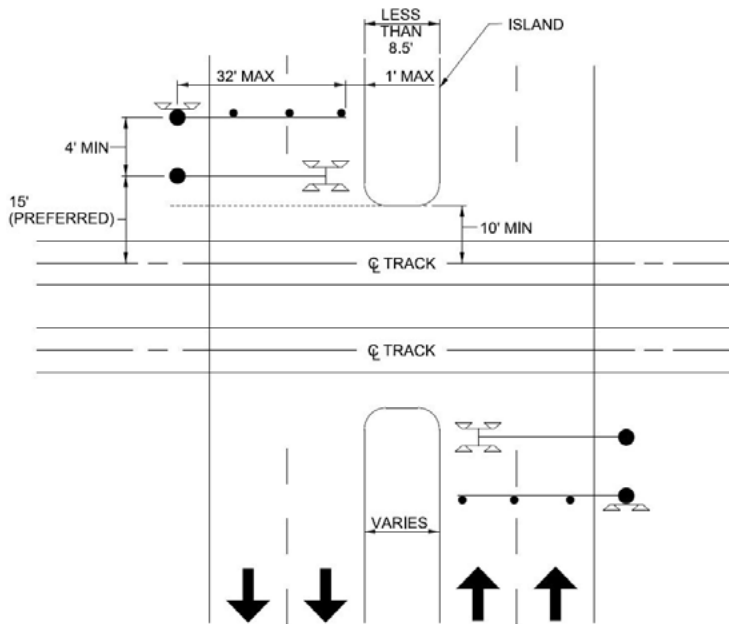

Figure 32. Typical Crossing Gate and Cantilever Placement at Multi-Lane Roadway with Medians and Median Gates—Cantilever Upstream from Gates

Source: Institute of Transportation Engineers.



Note: Location of crossing gate and cantilever may be switched

Figure 33. Typical Crossing Gate and Cantilever Placement at Multi-Lane Roadway with Medians and Median Gates—Cantilever Downstream from Gates

Source: Institute of Transportation Engineers.

Four-Quadrant Gates

Four-quadrant [gate](#)¹ systems consist of a series of automatic flashing-light signals and gates in which the gates extend across all roadway lanes on both the approach and the departure side of the crossing. Unlike two-quadrant gate systems, four-quadrant gates provide additional visual constraints and inhibit most traffic movements over the crossing after the gates have been lowered.

The use of four-quadrant gates has increased significantly in the past decade for two main reasons: (1) design criteria adopted by transit and commuter rail operators which requires use of gates on all crossing approaches, and (2) “Quiet Zones” where four-quadrant gates have been used for risk reduction.

There are two recognized methods for operation of the exit gates: timed or dynamic. In the first instance, exit gates operate on a delay timer to allow vehicles which pass by the entry gates to exit the crossing zone before the exit gates are lowered. In the second case, known as “dynamic exit gate operating mode,” an “exit gate management system” with detection loops in the crossing area is used to monitor vehicle presence within the crossing and hold open and/or raise the exit gates if vehicles are on the crossing after the entry gates are lowered. This second method is costlier to install and maintain but may be preferred at locations where the traffic flow rate is unpredictable to assure exit gates do not descend on vehicles. On the other hand, it is possible for a vehicle to back up into the vicinity of an exit gate loop and cause the gate to raise. It should be noted that some jurisdictions may require use of the dynamic operating mode by [policy](#).²

Entry gates are designed to “fail-safe in the down position” (e.g., they are powered up and if the power fails, they will lower by gravity). However, the failure mode for exit gates is to “fail-safe in the up position” so that vehicles do not become trapped on the crossing in the event of a power failure. Additional guidance for Four-Quadrant Gate Systems operation can be found in MUTCD Section 8C.06.

Four-quadrant gates are recognized as a “Supplemental Safety Measure” (SSM) in FRA regulations governing Quiet Zones (49 CFR Part 222, Appendix A). It should be noted that FRA has assigned a lower effectiveness rate to installations that include vehicle presence detection because the act of raising the exit gates may allow vehicles to enter the crossing. **Figure 34** shows four quadrant gate treatments for various conditions.

¹ Because of varying intersection configurations, not all crossings using exit gates have gates in all four quadrants; the term “Full Closure” is a broader characterization of crossings with gates to block exit lanes.

² For example, the California Public Utilities Commission (CPUC) requires use of a vehicle presence system “subject to a Commission staff diagnostic field meeting recommendation and an engineering study performed by railroad or local agencies” (General Order 75-D).

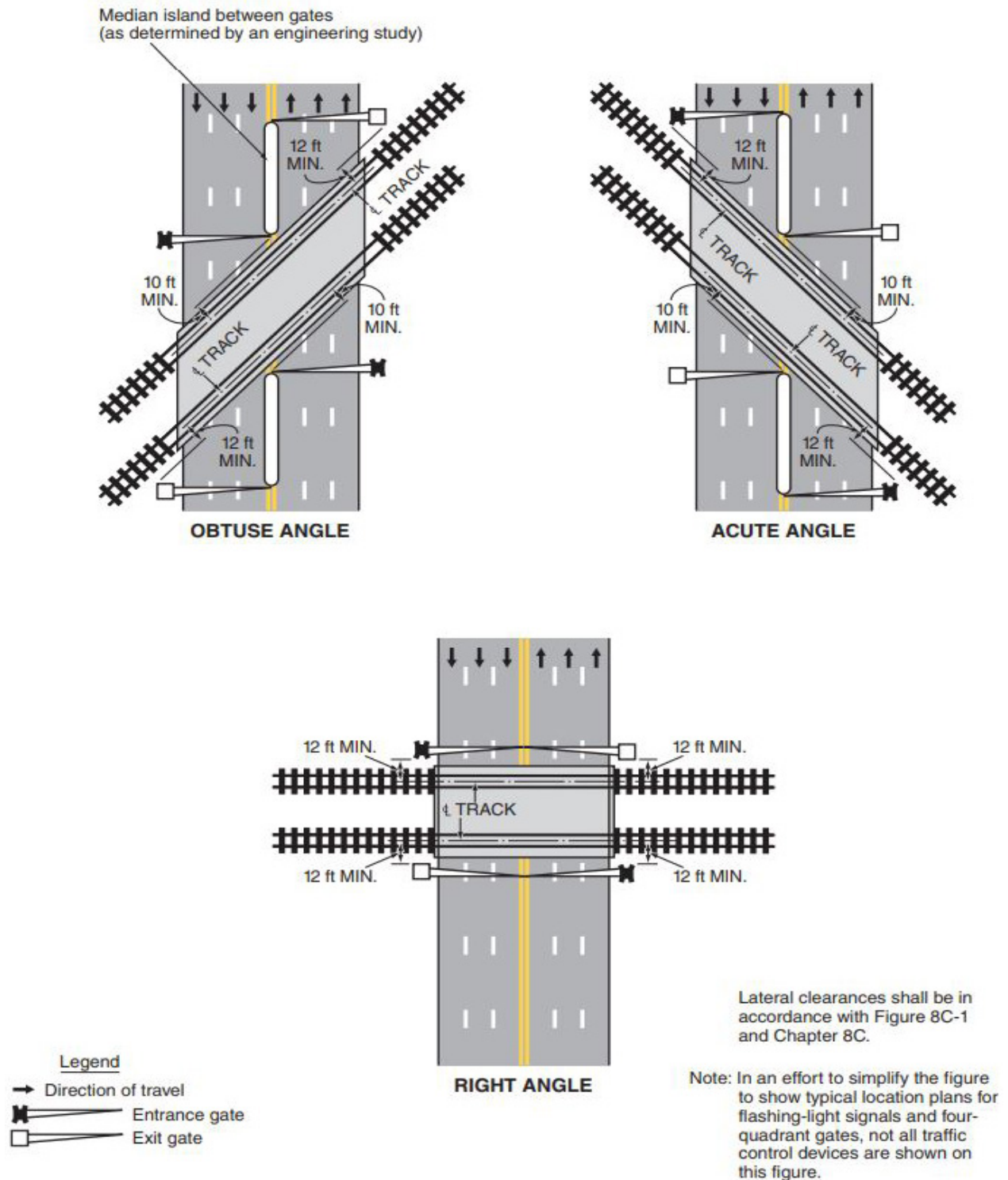

Figure 34. Example of Location Plan for Flashing-Light Signals and Four-Quadrant Gates

Source: Manual on Uniform Traffic Control Devices, 2009 Edition, Figure 8C-2, Washington, DC, FHWA, 2009.

Barrier Gate

The barrier gate is a movable automatic gate designed to close an approaching roadway temporarily at a highway-rail crossing (see **Figure 35**). A typical installation includes a housing containing electromechanical components that lower and raise the gate arm, the arm itself, and a locking assembly bolted to a concrete foundation to receive and hold the lowered gate arm in place. The barrier gate arm has been installed with a system consisting of three steel cables, the top and bottom of which are enclosed aluminum tubes.

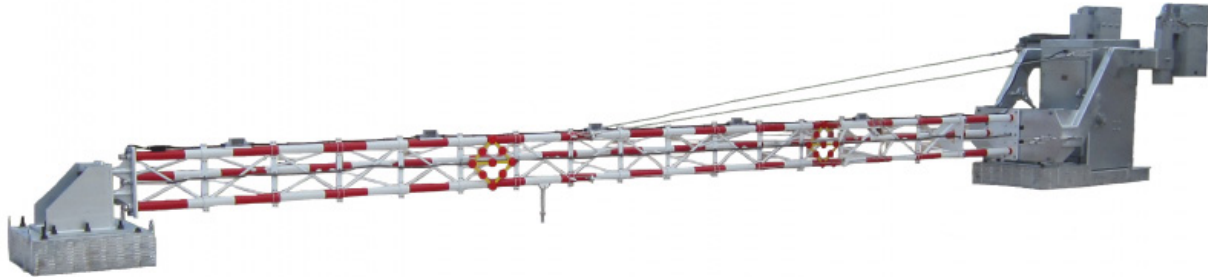

Figure 35. Example of a Resistance Barrier

Source: B&B Roadway—Resistance Barrier. (n.d.). Retrieved July 17, 2018, from <http://bbroadway.com/site/products/vt-6802hdtr/>

Barrier devices should at least meet the evaluation criteria for a MASH⁽²⁴⁾ attenuator; stopping an empty 4,500-pound pickup truck traveling at 43 mph. Barrier gates have been tested to safely stop a pick-up truck traveling at 45 mph.

Barrier gates could be applied to situations requiring a positive barrier, such as closing-off road traffic and opening crossings only on demand. FRA regulations⁽⁷⁾ also require use of FRA-approved barrier and/or enhanced warning systems for train operation over 110 mph. FRA has indicated that a barrier gate, if equipped with monitoring device, may be used to enforce a nighttime closure for partial quiet zones.

USE OF CHANNELIZATION WITH GATES

At many crossings, drivers can cross the centerline pavement marking and drive around a gate with little difficulty. The number of crossing gate violations can be reduced by restricting driver access to the opposing lanes. Highway authorities have implemented various median separation devices, which have shown a significant reduction in the number of vehicle violations at crossing gates.⁽³⁰⁾

Various styles of median treatments include barrier wall systems, wide raised medians, and mountable raised curb systems. In addition to discouraging crossing gate evasion, such treatments may be used to restrict left-turns across the median to and from driveways or minor streets adjacent to the crossing thus reducing conflicting vehicular turning movements in the crossing vicinity. The benefits of installing channelization should be considered along with possible adverse effects on local access and circulation as well as the potential for a road user to strike the barrier. Medians and traffic channelizing devices need to be kept out of the path of turning vehicles to avoid being

struck. The median should be designed to allow vehicles to make left turns or U-turns through the median where appropriate, based on engineering judgment and evaluation.

It should be noted that median treatments meeting the requirements of Appendix A of 49 CFR Part 222 are considered supplemental safety measures by FRA for use in a quiet zone (see Quiet Zones).⁽⁵⁾

Barrier Wall Systems

Concrete barrier walls and guardrails prevent drivers from crossing into opposing lanes throughout the length of the installation. In this sense, they are the most effective deterrent to crossing gate violations; however, the road should be wide enough to accept the width of the barrier and the appropriate end treatment. Sight restrictions for vehicles with low driver eye heights and any special needs for emergency vehicles to make a U-turn maneuver should be considered (but not for circumventing the traffic control devices at the crossing). To increase the effectiveness of barrier wall systems, they should extend from the crossing to a length of 100 feet.

Wide Raised Medians

Curbed medians typically range in width from 4 to 16 feet, although wider medians may be present along divided highways. Although they do not present a true barrier, wide medians can be nearly as effective because a driver would have significant difficulty attempting to drive across to the opposing lanes. The impediment becomes more formidable as the width of the median increases.

Drawbacks to implementing wide, raised medians include the availability of sufficient ROW and the maintenance of surface and/or landscape. Additions such as trees, flowers, and other vegetation higher than 3 feet above the roadway can restrict drivers' views of approaching trains. Maintenance can be expensive, depending on the treatment of the median. Limitation of access can cause property owner complaints, particularly for businesses.

Non-Mountable (Non-Traversable) Curb Islands

Non-mountable curb islands are typically 6 to 9 inches in height and at least 2 feet wide and may have flexible, reflectorized tubular delineators or vertical panels. Drivers have significant difficulty attempting to violate these types of islands because the 6- to 9-inch heights cannot be easily mounted and crossed.

Some disadvantages should be considered. The road must be wide enough to accommodate a 2-foot median. The increased crash potential should be evaluated. AASHTO recommends that special attention be given to high visibility if such a narrow device is used in higher-speed (greater than 40 mph) environments.⁽²²⁾ Care should be taken to assure that an errant vehicle cannot bottom-out and protrude into the oncoming traffic lane. Sight restrictions for low driver eye heights should be considered if tubular delineators or vertical panels are installed. Access requirements should be fully evaluated, particularly allowing emergency vehicles to cross opposing lanes (but not for circumventing the traffic control devices at the crossing). Paint and reflective beads should be applied to the curb for night visibility.

The State of Illinois has developed a standard that uses a combination of mountable and non-mountable curbs to provide a wide, raised median with escape zones both in the median, as well as to the shoulder (see **Figure 36**). This treatment is intended to allow vehicles trapped on the tracks due to queued traffic to maneuver from the crossing to a safe area in the median or on the shoulder.

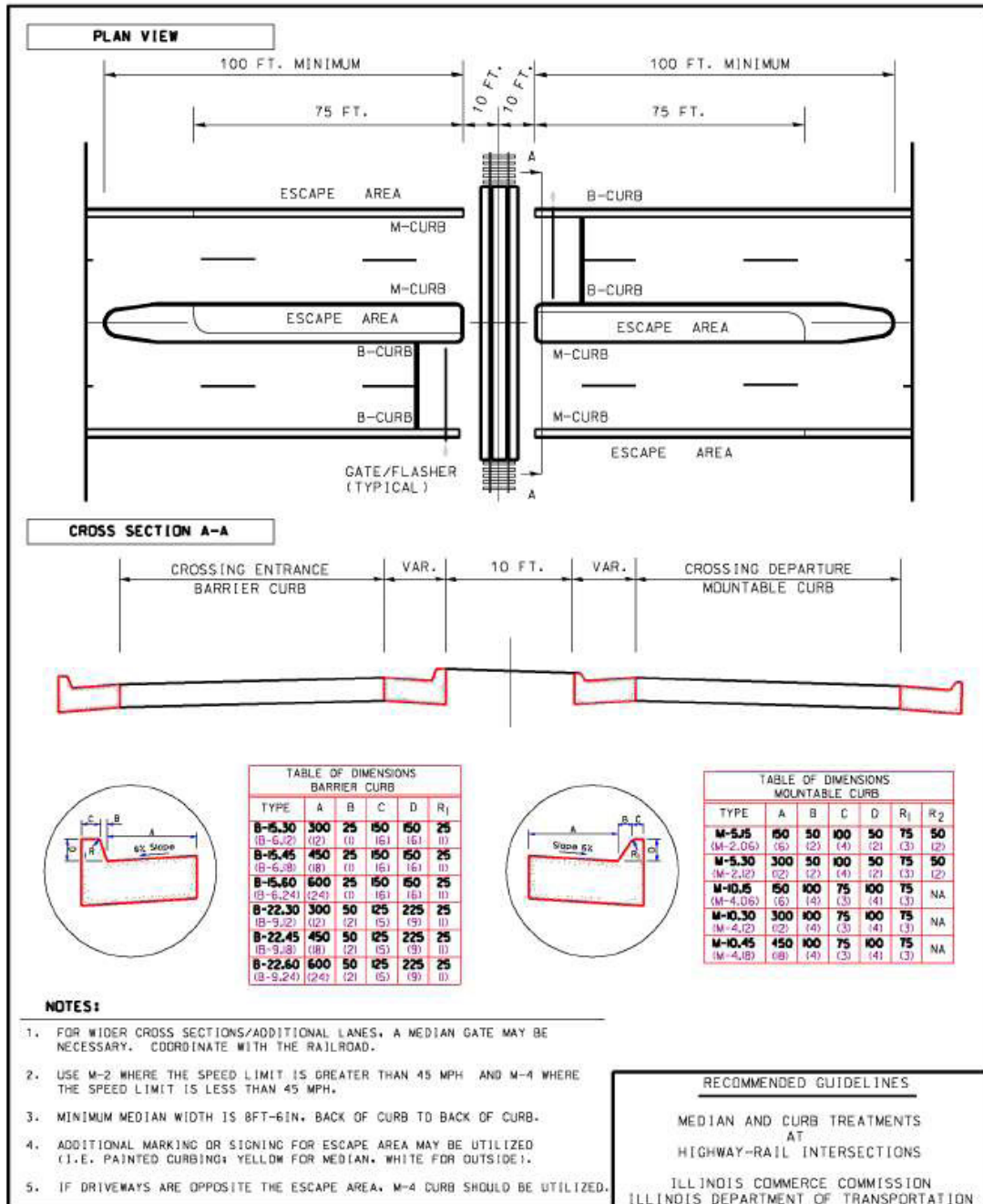

Figure 36. Example of Combination of Mountable and Non-Mountable Curbs from Illinois Department of Transportation

Source: Illinois Department of Transportation, Bureau of Local Roads and Streets Manual, Illinois DOT, Revised June 2018, Mountable Raised Curb Systems.

Mountable Raised Curb Systems (Traffic Separators)

Mountable raised curb systems or “traffic separators,” with flexible tubular delineators or vertical panels present drivers with a visual impediment to crossing to the opposing traffic lane (see **Figure 37**). The curbs are no more than 6 inches in height, less than 12 inches in width, and built with a rounded design to create minimal deflection upon impact. When used together, the mountable raised median and tubular markers or vertical panels discourage passage. These systems are designed to allow emergency vehicles to cross opposing lanes (but not to circumvent the traffic control devices at the crossing). Usually, such a system can be placed on existing roads without the need to widen them.



Figure 37. Example of a Traffic Separator

Source: USDOT, Federal Railroad Administration, Research Results 10-03 (Washington, DC, June 2010).

Because mountable curbs are intended to allow emergency vehicles to cross and are designed to deflect errant vehicles, they also are the easiest of all the barriers and separators to violate. Large, formidable tubular delineators or vertical panels will inhibit most drivers. Care should be taken to ensure that the system can withstand normal traffic conditions and that retroreflective surfaces are maintained in good condition for night-time visibility. Additional guidance is found in the MUTCD Section 3B.23.

These mountable raised curb systems have proven effective and are relatively inexpensive compared to treatments which require roadway reconstruction.⁽³⁰⁾ These traffic separators are installed along the centerline of roadways, in most cases extending approximately 70 to 100 feet from the crossing. They prevent motorists from crossing lanes to “run around” activated crossing gates. The separators consist of prefabricated, mountable islands made of a composite material. Attached to the islands are vertical panels or tubular delineators with retroreflective surfaces for better visibility at night. The vertical panels or tubular delineator are flexible, yet securely anchored allowing them to return to their original positions if struck by a vehicle.

PREEMPTION OF TRAFFIC SIGNALS

Because a downstream traffic signal may cause traffic to back up toward and/or through a grade crossing, it is essential that provisions be made to allow traffic to clear from the track area prior to train arrival. This is accomplished by means of traffic signal “preemption”—the normal sequence of operation is suspended and a programmed alternative sequence takes over. A preemption sequence compatible with railroad crossing active traffic control devices is extremely important to provide safe vehicular and pedestrian movements. Such preemption serves to ensure that the actions of these separate traffic control devices complement rather than conflict with each other.

The MUTCD (see Section 8C.09) indicates that grade crossings with active warning devices (such as flashing-light signals with or without gates) located within 200 feet of an intersection or midblock location controlled by a traffic signal should be interconnected with the nearby intersection’s traffic control system such that the railroad devices can send a preemption call to the highway signals upon detection of an approaching train. The MUTCD also indicates that coordination with the flashing-light signal system, queue detection, or other alternatives should be considered for traffic signals located further than 200 feet, while taking into consideration traffic volumes, highway vehicle mix, highway vehicle and train approach speeds, frequency of trains, and queue lengths.

At a signalized intersection located within 200 feet or less of a crossing, where the intersection traffic control signals are preempted by the approach of a train, all movements from the signalized intersection approaching the crossing should be prohibited during the signal preemption sequences.

A blank-out or Changeable Message Signs (CMS) and/or appropriate highway traffic control signal indication (such as a red arrow indication where a left-turn bay is present) or other similar type sign may be used to prohibit turning movements toward the highway-rail crossing during preemption. These signs may include supplemental blank-out legend which display the word or symbol for trains or LRT.

To understand the concept of preemption, the practitioner should be familiar with two fundamental terms which are depicted in **Figure 38**. The Clear Storage Distance (CSD) is the space between the crossing and a downstream intersection where vehicles may safely queue and the Minimum Track Clearance Distance (MTCDD) is the area which must be clear of roadway vehicles to avoid a collision with a train. These are defined as follows:

Clear Storage Distance. Per the MUTCD definitions, (Part 1A.13), the distance available for vehicle storage measured between 6 feet from the rail nearest the intersection to the intersection stop line or the normal stopping point on the highway. At skewed crossings and intersections, the 6-foot distance is measured perpendicular to the nearest rail either along the center line or edge line of the highway, as appropriate to obtain the shorter distance. Where exit gates are used, the distance available for vehicle storage is measured from the point where the rear of the vehicle would be clear of the exit gate arm. In cases where the exit gate arm is parallel to the track(s) and is not perpendicular to the highway, the distance is measured either along the center line or edge line of the highway, as appropriate, to obtain the shorter distance.

Minimum Track Clearance Distance. For standard two-quadrant warning devices, the MTCD is the length along a highway at one or more railroad tracks or LRT tracks. Where flashing-light signals with automatic gates are used, the MTCD is measured from the portion of the gate arm farthest from the near rail. Where flashing-light signals are used without automatic gates, the MTCD is measured from the stop line. Where passive traffic control devices are used, the MTCD is measured from the stop line. Where the roadway is not paved, the MTCD is measured from 10 feet perpendicular to the near rail. The MTCD ends 6 feet beyond the track(s) measured perpendicular to the near rail. The MTCD ends 6 feet beyond the track(s) measured perpendicular to the far rail, along the center line or edge line of the highway, as appropriate, to obtain the longer distance. For Four-Quadrant Gate systems (where exit gates are used), the MTCD is extended to the point where a vehicle is clear of the exit gate arm. In cases where the exit gate arm is parallel to the track(s) and is not perpendicular to the highway, the distance is measured either along the center line or edge line of the highway, as appropriate, to obtain the longer distance.

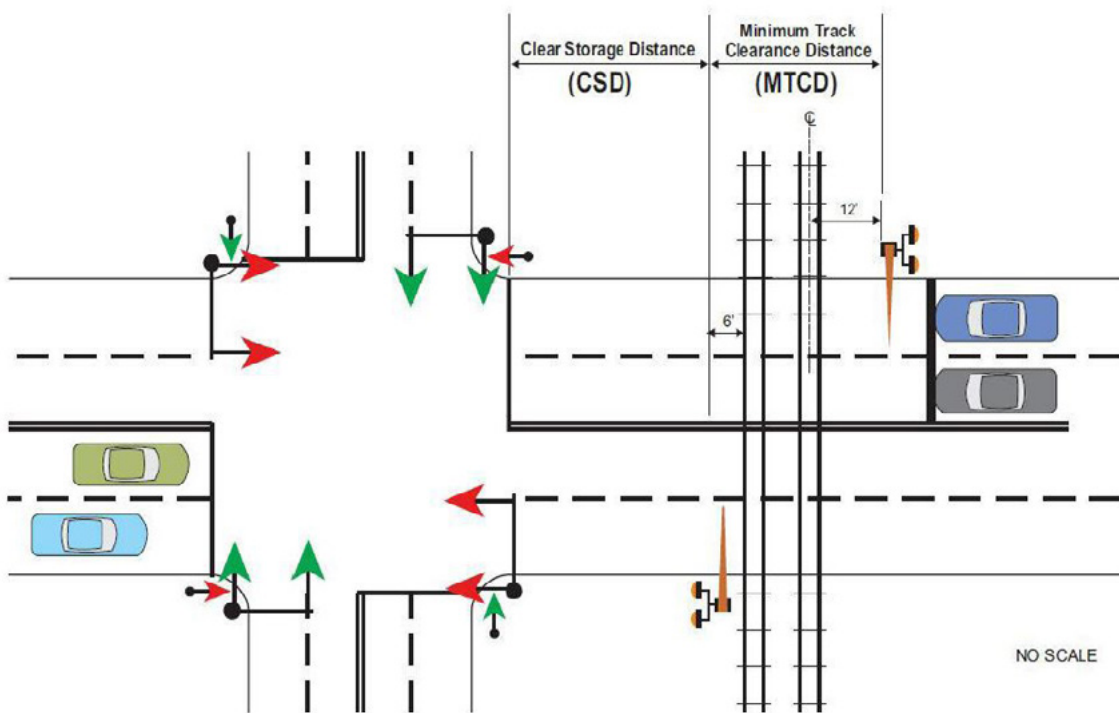

Figure 38. Clear Storage and Minimum Track Clearance Distance

Source: AECOM, Inc.

Excerpts from ITE Recommended Practice on Preemption of Traffic Signals Near Railroad Crossings

It is beyond the scope of this *Handbook* to incorporate all specifics regarding preemption of traffic signals near crossings. The following material has been synthesized from the recently updated (2019) ITE Proposed Recommended Practice: *Preemption of Traffic Signals Near Railroad Crossings*; practitioners involved with implementation of preemption should use the full document as a reference.⁽³⁾

- Where a signalized highway intersection exists in close proximity to a railroad crossing and either the crossing is impacted by queues from the intersection or the intersection is impacted by queues from the crossing, the railroad signal control equipment and the traffic control signal control equipment should be interconnected, and the normal operation of the traffic signals controlling the intersection should be preempted to operate in a special control mode when trains are approaching (MUTCD). A preemption sequence compatible with railroad crossing active traffic control devices is extremely important to provide safe vehicular and pedestrian movements. Such preemption serves to ensure that the actions of these separate traffic control devices complement, rather than conflict with, each other.
- Where a signalized highway intersection is not in close proximity to a railroad crossing, coordination between the traffic control signal and railroad warning devices may still be necessary. Coordination is essential where vehicular queues periodically or routinely extend onto the railroad crossing, and may include preemption or queue management techniques such as queue detection, queue-cutter signals, or dynamic control of traffic control signal timing plans to eliminate queuing on the tracks.
- It is important that the traffic engineer responsible for designing the preemption system understand with sufficient detail how the traffic control signal controller unit operates in response to a call for a preemption sequence. The traffic engineer should also ensure that the traffic control signal controller unit is capable of performing all of the functions required under all possible rail movements in order to provide proper functioning of the preemption operation. Rail operations such as multiple train movements, stops within the approach circuitry, and re-starts of stopped trains within the approach circuitry can result in insufficient queue clearance time from the train detection circuitry. The traffic engineer should consult with railroad personnel responsible for railroad signal design and operations to ensure that appropriate equipment is specified and that both highway and railroad signal installations operate properly and with full compatibility. Continuous cooperation between highway and railroad personnel is essential for safe operation. Information concerning the type of railroad signal equipment that can be used is available from the operating railroad and from the AREMA *Communications and Signal Manual*.⁽²⁹⁾ In addition, State and local regulations should be consulted.

When to Preempt

If either of the following conditions is present, careful consideration should be given to interconnecting traffic signals on public and private highways with active warning devices at railroad crossings:

- Highway traffic queues have the potential for extending across a railroad crossing from a nearby highway traffic signal
- Traffic queues from a railroad crossing have the potential to interfere with a nearby highway traffic signal

A railroad crossing equipped with a passive control device may need to be upgraded to an active warning device so that preemption of the traffic control signal can be effectively implemented. Such improvements are particularly important when the tracks are close to the signalized intersection or when certain conditions exist, such as vehicles queuing onto the tracks, high-speed train or highway approaches, tracks in highway medians, steep grades, or traffic that includes school buses or trucks carrying hazardous material.

Traffic Queues Extend Across the Railroad Crossing

If traffic queues extend onto the railroad crossing from a nearby highway traffic signal, then it is essential to provide some means of clearing vehicles off the tracks before a train arrives. Current practice is to consider use of preemption where a traffic signal is within 200 feet of a crossing. However, the MUTCD notes that coordination with the flashing-light system, such as queue detection, should be considered for traffic signals located farther than 200 feet from the crossing. Two-hundred feet is an approximation of the distance within which traffic queuing is likely to occur. Regardless of the actual distance between the railroad crossing and a traffic signal, preemption or coordination should be considered whenever there is a likelihood that queuing will impact either the railroad crossing or the highway intersection. Factors that could affect queuing include traffic volumes, vehicle mix, train frequency, presence of driveways or unsignalized intersections, and traffic backed up from a nearby downstream intersection.

Long Distances

Where the Clear Storage Distance (CSD) exceeds 200 feet, the likelihood of a queue extending across the tracks should be determined. One or more of the following methods may be used to make this determination:

- Anecdotal Evidence—Highway authority technical staff, police, train operators, or train dispatchers may have observed queuing on the tracks. Anecdotal information may be especially useful to identify time periods of concern or other causative factors which could be verified through subsequent field observation.

- **Traffic Engineering Calculations³**—For isolated signalized intersections, conventional computations can be developed to estimate queuing based upon vehicle arrival rates, the vehicle mix, and traffic control signal timing. A wide range of commercially available software may be used as well.
- **Traffic Simulation Modeling**—Intersections located along highly-congested roadway segments or which are operating as part of a coordinated system of signals may be evaluated using traffic simulation software. Simulation software may also help address unusual traffic patterns such as special event traffic.
- **Field Observations**—Visual queue arrival and dissipation studies may be made during multiple peak travel demand times at the site. Video surveillance equipment may be installed and data recorded during periods of concern. Field observations should consider significant traffic generators which may impact queuing such as shopping centers during peak seasons, schools when they are in session, and sporting events.

Neither the MUTCD 200-foot threshold nor the queue calculation equation is intended to provide a specific distance as the sole criterion for interconnecting railroad and highway signals. Special consideration should be given where upstream signals cause vehicles to arrive in platoons that could result in long queue lengths. Unusual 15-minute peak-period flow rates should be evaluated. For example, where a mix of long slow trains and short fast trains could be present at multi-track crossings, it is possible that a long queue of vehicles may develop at the crossing as a slow, long train passes; subsequently, this long platoon of vehicles could be advancing through the crossing when a fast, short train arrives. Pre-signals and queue cutters may be effective for long distances.

Short Distances

Where the CSD is not sufficient to store the longest vehicle known to use the crossing (the “design vehicle”), or if vehicles regularly queue across the tracks, a pre-signal may be considered. An engineering study should be performed to support this recommendation. Where no crossing gates are present, a pre-signal can discourage design vehicles from stopping in the CSD or in the MTCD.

Additional Preemption Issues

Other issues to consider in the evaluation of the implementation of preemption include the following:

- **Trucks and Vehicles Required to Stop by Law**—Additional clearance time may be required; if a truck is turning toward the tracks and encounters lowered crossing gates it may be stopped in a position blocking the departure lanes.
- **Grades**—The presence of an upgrade on the approach will require consideration of additional clearance time, especially for heavy vehicles.

³ “Timing of Traffic Signal Preemption at Intersections Near Highway-Rail Grade Crossings,” Robert K. Seyfried. ITE 2001 Annual Meeting and Exhibit CD-ROM, ITE, 2001.

- **Crossing Gate Spillback**—Even if traffic can clear from the tracks in advance of the arrival of a train, queues may spill back into an adjacent intersection resulting in blockage of movements. Interconnection can be used to address such issues.
- **Circular Intersections**—Although roundabouts and traffic circles are designed to operate without traffic signals, they may become congested resulting in blockage of a crossing on an approach leg. Mitigation may require installation of a traffic control signal or queue cutter signal.
- **Light Rail Crossings**—Although gate down (A crossing gate is in the “down” or lowered position when it is horizontal in accordance with the predetermined design from vertical, which is typically 85 to 92 degrees depending on specific gate mechanism adjustment and other factors) times for LRT are relatively short, frequent activations will require that the system be designed to handle the approach of a second train possibly arriving during the preemption sequence for the first train. Also, motion sensing and Constant Warning Time (CWT) devices may not operate properly in electrified systems, and special devices or track circuits will likely be required. Because there is typically little variability in train speeds on LRT tracks, CWT devices are often not necessary.

Preemption Operation Modes

Preemption of traffic signals may be either simultaneous or advance as determined by the diagnostic team. Simultaneous preemption occurs when notification of an approaching train is forwarded to the highway traffic control signal controller unit and the railroad active warning devices at the same time. Advance preemption occurs when notification of an approaching train is forwarded to the traffic control signal controller unit by railroad equipment for a period of time prior to the activation of the railroad active warning devices.

Preemption operation, whether simultaneous or advance, requires the consideration of three fundamental timing parameters:

- **Right of Way Transfer Time (RWTT)**—The time required to transition into track clearance
- **Queue Clearance Time**—The time required to clear traffic from the MTCD
- **Separation Time**—The time between the clearance of the last vehicle and the arrival of a train

The sum of these three parameters is the Maximum Highway Traffic Signal Preemption Time (MPT). It is also the required minimum amount of time from when the preemption interconnection is activated and the time that the train arrives at the crossing.

Simultaneous Preemption Operation

With simultaneous preemption, the railroad warning devices are active for the entire duration of the MPT since both systems are activated simultaneously. In most cases, calculation of the necessary time elements for preemption operation will find that additional warning time from the railroad is necessary. The additional time is specified as Clearance Time, which is added to the minimum warning time.

Simultaneous preemption can be used at locations where the track is located in the center of the preempted intersection or where the CSD is very short and has a short queue clearance time.

Advance Preemption Operation

With advance preemption, the traffic control signal controller begins the preemption sequence for a period before the railroad warning devices are activated. The difference between the MPT and the activation of the railroad warning devices is called the advance preemption time. Where there is a long MPT, advance preemption can reduce the length of time the railroad warning devices operate before the preemption clearance interval begins.

The use of advance preemption requires close coordination between highway agencies and the railroad companies to ensure that all parties fully understand the operation of each other's system. The additional time required to be provided from the railroad signaling system to provide the MPT requirement may result in an increase in cost for the installation and maintenance due to the additional control equipment and complexity of the railroad circuitry.

Interconnection Control Circuits

The approach of a train to a railroad crossing de-energizes the interconnection or sends a message via a fail-safe data communication protocol, which in turn activates the traffic control signal controller preemption sequence. Preemption should be implemented with an interconnection using fail-safe design principles. Types of fail-safe connections include the following:

- **Single Break with Supervision**—A supervised preemption interconnection incorporates both a normally-open and a normally-closed circuit from the crossing warning system to verify the proper operation of the interconnection.
- **Double Break (with or without Supervision)**—In lieu of or in addition to supervision, a double break preemption interconnection circuit utilizing two normally-closed circuits that open both the source and return energy circuits may be used.
- **Data Communication (IEEE 1570)**—This standard utilizes the vital data protocol IEEE 1570. It is a hybrid between Intelligent Transportation Systems (ITS) and rail signaling technologies in which railroad warning devices are considered “vital equipment,” and as such are designed using fail-safe principles.

Queue Management

Queue management can be provided through use of Pre-Signals, Queue Cutters, combination Pre-Signal/Queue Cutter installations, or through use of coordinated traffic signals.

- **Pre-Signals**—As defined by the MUTCD (Section 1A.13), Pre-Signals are “traffic control signal faces that control traffic approaching a grade crossing in conjunction with the traffic control signal faces that control traffic approaching a highway-highway intersection beyond the tracks.” Pre-signals can be used to stop vehicular traffic before the railroad crossing in cases where the CSD, measured between 6 feet from the rail nearest the intersection to the intersection stop line or the normal stopping point on the highway) is 50 feet or less (or 75 feet if the design vehicle is longer). Pre-signals can also be used where the CSD is as much as 200 to 250 feet, depending on vehicle lengths. In this case, it is not expected that all vehicles will be cleared from the CSD; only from the MTC. (Note: Where the CSD is one design vehicle length or less, relocating the stop line upstream of the crossing may be sufficient to control queuing without the need for a pre-signal.)
- **Queue-Cutter Signals**—In cases where the crossing is located farther than 450 to 500 feet (depending on vehicle lengths) from the highway intersection, the use of preemption with or without a pre-signal can lead to very long preemption times and approach circuits so that all vehicles downstream from the crossing can move and allow the crossing to clear which may be impractical. One remedy to consider in this case is a queue-cutter signal. A queue-cutter is a traffic control signal which only controls traffic approaching a crossing and is operated independently of other traffic signals in the vicinity. The concept of operation of a queue-cutter is to hold traffic (“cut the queue”) upstream from a crossing before a queue caused by a downstream traffic control signal or other roadway congestion can grow long enough to back up into the crossing. Queue-cutter signal operation may be based on downstream queue loop detectors, timed operations, or a combination of the two.
- **Combination Pre-Signal/Queue Cutter Signal**—Queue-cutter signals are used where the CSD exceeds 450 to 500 feet (depending on vehicle lengths) because room is needed downstream from the crossing to detect the development of a queue as well as store vehicles (including a design vehicle) which continue to cross until the approaching traffic is stopped. Queue cutters may also be considered where the CSD is between 200 and 450 feet if they operate in a hybrid mode as a combination pre-signal and queue-cutter signal. The presence of an effective queue-cutter can eliminate the need for preemption of the downstream traffic signal. The suggested distances are guidelines and can vary depending on traffic volumes, peaking characteristics, arrival patterns, and other factors.
- **Coordinated Traffic Signals**—As a variation of queue-cutter signals, traffic control signal coordination may be provided to manage queues along a roadway segment which includes a crossing. Within a network of coordinated traffic signals, the likelihood of queuing within the MTC can be reduced by providing more green time and capacity at the traffic control signal downstream from a crossing relative to the green time and capacity provided for movements approaching the crossing.

In addition to active traffic control of queuing, there may be locations where use of an active warning sign may be more appropriate. If traffic has the potential to back up from a STOP sign-controlled intersection where signalization is not justifiable, or if traffic occasionally backs up due to special events, an active warning sign activated by time-of-day or queue detection could be provided to remind road users of the risk of stopping on the crossing. Options include use of an active blank-out “DO NOT STOP ON TRACKS” (R8-8) sign or a warning beacon and passive sign including the phrase “WHEN FLASHING” (refer to MUTCD Section 4L.03).

Comparison of Queue Management Techniques

Table 5 summarizes the typical CSD ranges and key operational characteristics of pre-signals, queue cutters, and traffic control signal coordination as used to control queuing near a crossing. The CSD ranges reflect variations in vehicle lengths. Where there is a significant percentage of long vehicles, the higher end of each range should be used. The CSD ranges are guidelines and can vary depending on traffic volumes, speeds, peaking characteristics, arrival patterns, and other factors. It should be noted that the operational parameters and design characteristics of Hybrid Pre-Signal/Queue Cutter signals need to be adapted to site geometric and traffic flow conditions especially regarding placements of signal heads, loop detectors, and pavement markings.

Additional information provided in the *ITE Recommended Practice*.

As noted in the introduction to the preemption topic, the information presented in the *Handbook* is intended as an introduction to preemption. The *ITE Recommended Practice* covers these topics and many more in depth as noted:

- Train Detection
- Interconnection Control Circuits
- Crossings Between Two Signalized Intersections
- Diagonal Intersections
- Pre-Signals Design and Operations
- Queue Cutter Design and Operations
- Preemption Timing Parameters
- Use of Gate Down Circuit
- Preemption Hold Interval
- Exit to Normal Operations
- Pedestrian Signal Indications
- Considerations with Exit Gates
- Case Studies

Table 5. Comparison of Queue Management Devices and Techniques

Clear Storage Distance	Application	Key Operational Characteristics
Less than 50–75 ft ^a	Relocated Stop Line with or without Pre-signal	<ul style="list-style-type: none"> • Relocate stop line to upstream of tracks • At the upper end of distance range, consider providing a pre-signal • Intersection signal timing plan should clear the CSD as well as the MTCD
50–75 ft to 200–250 ft ^a	Pre-signal	<ul style="list-style-type: none"> • Pre-Signal operates continuously in coordination with downstream traffic signal; should include green offset • Timing plan provides queue clearance time sufficient to clear the MTCD but vehicles may remain in CSD
200–250 ft to 450–500 ft ^a	Hybrid Pre-signal/ Queue-Cutter	<ul style="list-style-type: none"> • Hybrid pre-signal operates continuously in coordination with downstream traffic signal; should include green offset • Timing plan provides queue clearance time sufficient to clear the MTCD but vehicles may remain in CSD • Hybrid pre-signal should have queue detection to extend the duration of the red interval until an adequate downstream gap exists • Queue-cutter signal generally operates independently of downstream traffic control signal for queue prevention on crossing in off-peak periods to reduce unnecessary signal cycling
450–500 ft ^a or more	Queue-Cutter	<ul style="list-style-type: none"> • Queue-cutter operates when required to prevent queuing in MTCD • Activation and timing plan designed to prevent vehicles from queuing in the MTCD but vehicles may queue in CSD • May eliminate need for preemption of downstream traffic signal
Variable	Coordinated Traffic Signals	<ul style="list-style-type: none"> • Provided there is adequate CSD and traffic signals are appropriately spaced, signals may be interconnected and operated as a system to move vehicles through crossing in manageable platoons such that queuing in the MTCD is avoided; vehicles may queue in CSD

^aBased upon length of vehicle used as the basis for design.

Pre-Signal and Queue Cutter Design Considerations

This section provides illustrative examples of pre-signal and queue cutter treatments demonstrating various design options. Design considerations for pre-signals include placement of the pre-signal heads, stop line placement, and whether the downstream intersection signal should be modified to limit the visibility of the green indication. For queue cutters, in addition to the placement considerations, the means of operation (with or without detection) and location of the detection zone (if provided) are prime concerns.

The location of pre-signal mast arm poles can be located upstream or downstream from the railroad crossing. In all cases, pre-signal poles should be located to maintain visibility of the railroad flashing-lights. If an existing railroad cantilever exists, and upstream pre-signals are used, the heads may be mounted on the cantilever if permitted by the railroad or regulatory agency. If they are on a separate mount, they should be located to avoid blockage or interference with the visibility of the railroad flashing-lights. Railroad flashing-lights should be located as specified in Chapter 8C of MUTCD. Refer also to AREMA *Communications and Signal Manual* Parts 3.1.36 and 3.1.37 for additional guidance regarding the location of railroad warning devices.⁽²⁹⁾

Traffic control signal faces at the downstream intersection may be equipped with programmable-visibility heads or louvers as appropriate based on an engineering study to minimize road user confusion. The purpose of the signal programmable-visibility heads or louvers is to limit visibility of the downstream signal faces to the area from the intersection stop line to the location of the first vehicle behind the pre-signal stop line. This is to prevent drivers stopped at the railroad crossing stop line from seeing the distant green signal indication which would be displayed during the track clearance interval. An engineering study should be conducted to review the specific site conditions, including the eye heights of drivers of vehicles likely to use the crossing, and establish the final design necessary to meet the visibility requirements.⁽³¹⁾

Where the CSD is greater than that which is typical for a pre-signal, a combination pre-signal/queue cutter should be considered. In addition to the head placement considerations associated with pre-signal design, queue cutter design should consider whether it is feasible to provide detection as well as the placement of the detection zone. If adequate storage exists such that a detection zone can be provided, an adequate distance beyond the crossing to store additional vehicles which would arrive during the detection, phase change and driver response time, then the queue cutter can operate independent of any downstream signal. On the other hand, if such storage does not exist, then the queue cutter may need to be tied into the downstream signal to be effective (resulting in a hybrid installation). If a hybrid signal is provided, then the detection zone can be placed closer to the crossing because its purpose is purely to determine when the hybrid signal can revert to a green indication.

Relocated Stop Line

Figure 39 shows placement of the stop line ahead of the grade crossing, in conjunction with use of STOP HERE ON RED (R10-6) and DO NOT STOP ON TRACKS (R8-8) signs. As the CSD is minimal, it was not necessary to use a pre-signal at this location.



**Figure 39. Illustrative Example Showing Use of Relocated Stop Line
(Dallas Rapid Transit Red Line S. Hampton Rd Crossing at Wright Street, Dallas, TX)**

*Source: Google Earth V 7.1.7.2602. (September 6, 2016). Hampton Rd near
Wright St, Dallas, TX, USA. 32°43'31.98"N, 96°51'24.76"W, Eye alt eye level. DirectX 2016.
Google Earth Pro. [January 30, 2019].*

Pre-Signal with Displaced Stop Line

Figure 40 shows where the pre-signal stop line has been placed ahead of the crossing to comply with MUTCD traffic signal visibility requirements. Despite the long distance to both the crossing and the downstream intersection, there is a high degree of driver compliance with the pre-signal at this location.



**Figure 40. Illustrative Example Showing Displaced Stop Line
(PCJX S. Mary Avenue Crossing at W. Evelyn Avenue, Sunnyvale, CA, USDOT 755037b)**

Source: Brent Ogden.

Pre-Signal Mounted Downstream from Crossing

Figure 41 shows a pre-signal mounted downstream from a single-track crossing. Placement of the pre-signal beyond the rail track allows placement of the stop line and crossing gates close to the track. The downstream signal has lowered heads on the green indications (see inset photo) to avoid confusion with the pre-signal red indication.



Figure 41. Illustrative Example Showing Downstream Mounted Pre-Signal (SCAX Sierra Avenue Crossing at Orange Way, Fontana, CA, USDOT 026145L)

Source: Brent Ogden.

Pre-Signal Mounted on Railroad Cantilever

Figure 42 shows a pre-signal mounted on the railroad cantilever. The CSD to E. Lakewood Blvd. is about 175 feet. Note the non-conflicting placement of flashing-light warning signals and traffic signal heads mounted on the railroad cantilever.



Figure 42. Illustrative Example of a Cantilever-Mounted Pre-Signal (CSX 120th Avenue Crossing at E. Lakewood Boulevard in Holland, MI, USDOT 234648C)

Source: Google Earth V 7.1.7.2602. (September 6, 2016). Lakewood Ave near Garden Ave, Holland, MI, USA. 42°48'17.52"N, 86°04'26.42"W, Eye alt eye level. DirectX 2016. Google Earth Pro. [January 30, 2019].

Queue Cutter

Figure 43 shows a queue cutter which utilizes detection loops. The CSD at this location is about 340 feet, and the detection zone is located about 100 feet downstream from the crossing which provides enough storage for vehicles which arrive during the detection—phase change—driver reaction time interval. Note that the primary queue cutter signal heads are located downstream from the crossing to assure the MUTCD visibility criteria is met; however, there are additional pole-mounted heads at the stop line along with a STOP HERE ON RED (R10-6) sign.



Figure 43. Illustrative Example of Queue Cutter (SCAX Balboa Boulevard Crossing at Roscoe Boulevard in Los Angeles, CA, USDOT 745989G)

Source: Google Earth V 7.1.7.2602. (September 6, 2016). Balboa Blvd near Roscoe Blvd, Los Angeles, CA., USA.34°13'20.42"N, 118°30'08.87"W, Eye alt eye level. DirectX 2016. Google Earth Pro. [January 30, 2019].

Queue Prevention Strategies

At highway-rail crossings located near signalized intersections, where traffic congestion precludes using standard traffic control signal preemption, traffic control strategies may be used to prevent queues from extending back over the tracks (see **Figure 44**). Standard traffic control signal preemption operates under the assumption that motor vehicles queue back from the nearby signalized intersection (signal D in **Figure 44**). The preemption sequence (occurring at the traffic signals downstream of the crossing) then clears these queued vehicles off the tracks before the train arrives at the crossing.

However, at some locations, it may not be practical or possible to clear vehicles from the tracks by preempting the downstream traffic signals. For example, if the roadway corridor extending downstream from the crossing is heavily congested, preempting the downstream traffic signals still may not allow motor vehicles to move forward enough to clear the crossing because of downstream congestion. If the level of traffic congestion is substantial, it may be necessary to preempt several downstream traffic signals, which requires an approaching train to be detected (and predicted) several minutes before it arrives at the crossing. In such cases, a queue prevention strategy may be more appropriate.

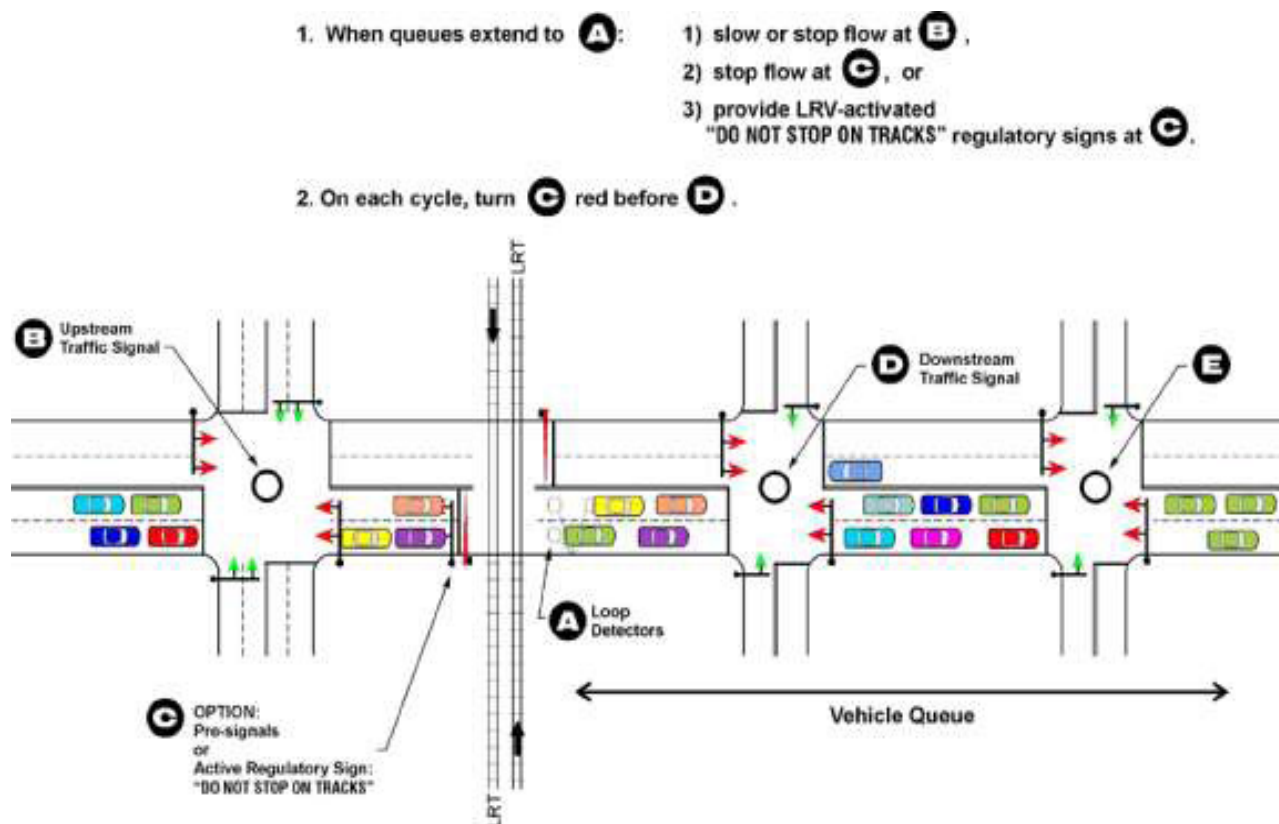

Figure 44. Queue Prevention Strategies

Source: Light Rail Service: Pedestrian and Vehicular Safety, Transit Cooperative Research Program Report 69.

The basic concept of queue prevention is as follows: If a queue is detected across a highway-rail crossing, traffic approaching the crossing will be stopped by a signal upstream of the crossing (signals B or C in **Figure 44**) to prevent the queue from building back across the tracks. As indicated, vehicle detectors can be installed at location A; if stopped or slow vehicles are detected at location A, logic built into the traffic control signal system could do the following:

- Stop the major flow of traffic at signal B (including control of turning traffic if necessary and appropriate)
- Stop the flow of traffic at signal C by using traffic signals on the near side of the crossing (such as pre-signals, previously described)
- Warn road users not to stop on the tracks by providing an activated, internally illuminated “DO NOT STOP ON TRACKS” sign (R8-8) mounted on a mast arm over each lane of traffic at location C (these signs would activate when queues are detected at location A)
- Provide exclusion zone cross-hatch striping, or other approved “Do Not Block” markings as described elsewhere in this *Handbook*

The advantage of queue management is that the crossing could potentially be kept clear of standing traffic regardless of whether a train was approaching the crossing, and the use of preemption would operate more as a fail-safe measure rather than a primary measure for keeping the tracks clear.

Management of Queueing at Frontage Roads

Use of STOP Signs

Frontage roads may present queueing challenges at crossings, especially if the CSD is very short and/or parallel roadway volumes are high. At locations where the frontage roadway is the minor street compared to the street with the crossing, it may be possible to install STOP signs on all approaches *except* the direction departing from the crossing. This treatment is illustrated in **Figure 45**. Note that STOP signs have been placed on both frontage road approaches to the crossing as well as the approach opposite the crossing. To advise road users that the traffic departing the crossing does not stop, supplemental plaques from the W4-4 series (“CROSS TRAFFIC DOES NOT STOP,” “TRAFFIC FROM LEFT (RIGHT) DOES NOT STOP,” or “ONCOMING TRAFFIC DOES NOT STOP”) may be used in conjunction with the respective STOP signs.

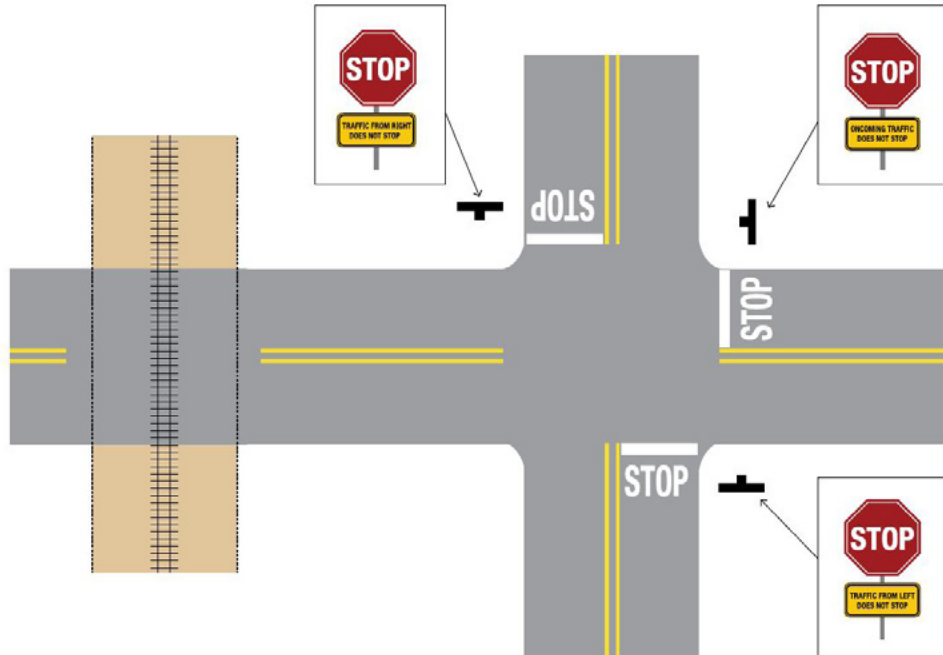

Figure 45. Illustrative Example of Stop Sign Placement

Source: Institute of Transportation Engineers.

Installation of New Traffic Control Signal

Where the parallel road is the major street at a frontage road intersection, use of STOP signs may be impractical. Such locations may justify the installation of a traffic control signal to ensure vehicles have an opportunity to clear the tracks prior to the arrival of a train. The MUTCD includes Warrant 9 (Section 4C.10) for a traffic control signal based on the proximity of an intersection to a crossing. The warrant is specifically intended to apply to situations in which the following occur:

- A major roadway runs more or less parallel to a line of railroad, and a minor roadway intersects both the major roadway and the line of railroad at grade.
- The resulting highway-highway intersection does not otherwise meet any of the other traffic control signal warrants in MUTCD.
- Motorist compliance with the existing (passive) traffic control devices at the highway-highway intersection often results in highway vehicles queuing across the nearby highway-railroad crossing.
- Other strategies to mitigate such queuing are deemed impractical, inappropriate, or not feasible.

It is likely that any traffic signals installed pursuant to this warrant would need to include provisions for railroad preemption which would in turn require modifications to track circuits to detect arriving trains. In addition, the proximity of the new signal would most likely require consideration for use of a pre-signal, queue cutter, or combination pre-signal/queue cutter.

Adjacent Railroad Crossings

Another circumstance which may result in queuing across a crossing is the presence of another nearby crossing—activation of the warning devices at one of the two crossings may result in queuing back across the adjacent crossing. In response to this concern, current practice (as presented in AREMA Chapter 3.1.11) may require interconnection between the two crossing warning systems.⁽²⁹⁾

The recommended practice is dependent upon the distance between the two crossings:

- Adjacent crossings within 100 feet—the crossings should be treated as one individual crossing.
- Adjacent crossings with 100 to 200 feet of separation—Additional signs or other appropriate traffic control devices should be used to inform approaching road users of the long distance to cross the tracks. “Interior” active devices (such as flashing-light signals with or without crossing gates) may be omitted.
- Adjacent crossings over 200 feet apart—Where the distance between tracks exceeds 200 feet, the operation of the devices should provide for additional time for vehicles to clear the extended MTC.

Additional guidance is in Part 3.1.11 of the AREMA Communications & Signals Manual.⁽²⁹⁾ Key provisions are as follows:

- Railroad companies should be provided with information regarding preemption and timing parameters to assist in their design of appropriate train detection circuitry. Unless the Diagnostic Team determines otherwise, normal sequence of traffic control signal indications should be preempted upon the approach of through trains to provide a preemption clearance interval of adequate duration to minimize the likelihood of vehicles not having sufficient time to clear the minimum track clearance distance prior to the arrival of the train. Flashing-light signal systems installed within 50 feet of any rail should be preempted upon the approach of a train.
- Activated by a supervised preemption interconnection, the approach of a train to a crossing should de-energize the interconnection or send a message via a fail-safe data communication protocol, which in turn should activate the traffic control signal controller preemption sequence. This should establish and maintain the preemption condition during the time the crossing warning system is activated to the point the automatic gates are energized to start their upward movement.
- At automatic gates, preemption clearance intervals which display green indications should be designed such that the green indications are not terminated until the automatic gates(s) is/are fully lowered.

Active Advance Warning Signs

The active advance warning sign (AAWS) consists of one or two 12-inch yellow warning beacons mounted in an assembly with the Advance Warning Sign (W10-1) and activated by detection of an approaching train. The beacons should be flashed in accordance with the provisions of MUTCD Chapter 4L. The AAWS is sometimes supplemented with a message, either active or passive, that indicates the meaning of the device, such as “TRAIN WHEN FLASHING.” A passive supplemental message remains constant; an active supplemental message changes when the device is activated by the approach of a train. The AAWS should continue to be activated until the crossing signals have been deactivated.

A train-activated advance warning sign should be considered at locations where the crossing flashing-light signals cannot be seen until an approaching motorist has passed the decision point (the distance from the track from which a safe stop can be made). Use of the AAWS may require some modification of the track circuitry. Consideration should be given to providing a back-up source of power in the event of commercial power failure. If such an advance device fails, the driver would not be alerted to the activated crossing controls. If there is concern for such failure, some agencies use a passive “RAILROAD SIGNAL AHEAD” sign to provide a full-time warning message.

The AAWS should be placed at the location where the advance warning sign would normally be placed, dependent on vehicle speed and the geometric conditions of the roadway. To enhance visibility at crossings with unusual geometry or site conditions, the devices may be cantilevered or installed on both sides of the highway. An engineering study should determine the most appropriate location.

TRANSIT AND ON-STREET RAIL

The MUTCD Section 8A.01 refers to LRT as “a mode of metropolitan transportation that employs LRT vehicles (commonly known as light rail vehicles, streetcars, or trolleys) that operate on rails in streets in mixed traffic, and LRT traffic that operates in semi-exclusive rights-of-way, or in exclusive rights-of-way. Grade crossings with LRT can occur at intersections or at midblock locations, including public and private driveways.” Traffic control for LRT is determined in part by the type of alignment:

- **Exclusive**—This type of alignment does not have grade crossings. The alignment is grade-separated or protected by a fence or traffic barrier. Motor vehicles, pedestrians, and bicycles are prohibited within the traveled way. Subways and aerial structures are included within this group. Because the alignment does not have grade crossings, there are no provisions for traffic control devices.
- **Semi-exclusive**—An alignment where the LRT operates within a separate traveled way or along a street or railroad ROW where motor vehicles, pedestrians, and bicycles have limited access and cross at designated locations only. In a semi-exclusive alignment, LRT vehicles usually have ROW over other roadway users at grade crossings.
- **Mixed-use**—An alignment where the LRT operates in mixed traffic with all types of road users. This includes streets, transit malls, and pedestrian malls where the traveled way is shared. In a

mixed-use alignment, the LRT vehicles or buses do not have ROW over other roadway users at grade crossings and intersections and LRT vehicles are usually controlled with the same devices used by general traffic.

It is important to understand that provisions in Part 8 of the MUTCD are intended to be applicable to both LRT and conventional railroads; therefore, when the phrase “grade crossing” is used by itself without the prefix “highway-rail” or “highway-LRT” it refers to both highway-rail and highway-LRT crossings. Conversely, LRT-specific provisions are indicated as applicable to “Highway-LRT Grade Crossings.” (In accordance with FRA requirements,⁽³²⁾ where LRT operates in the same corridor, e.g., “shared corridor” or on the same track as conventional rail, FRA requirements are applicable to both the conventional rail crossings as well as the LRT crossings in that corridor.) The MUTCD does not define the term “streetcar.” Although streetcar vehicles and trains resemble LRT, where streetcars operate in “mixed flow” in the same travel lane as other highway vehicles, traffic control treatments and provisions applicable to highway traffic in general are applicable to the streetcar operation. Where a streetcar operates in a semi-exclusive alignment, provisions and traffic control treatments applicable to LRT operating in a semi-exclusive alignment should be considered.

The LRT Traffic Control Systems is the overarching term used to describe the combination of devices selected or installed at a specific highway-LRT crossing. According to MUTCD Section 8A.03, there is not a single standard system universally applicable due to the many significant variables to be considered. The selection of traffic control devices and the assignment of priority to LRT at a highway-LRT crossing is jointly determined by the highway agency with jurisdiction, the regulatory agency with statutory authority, if applicable, and the LRT authority. The normal rules of the road and traffic control priority identified in the “Uniform Vehicle Code” govern the order assigned to the movement of vehicles at an intersection unless the local agency determines that it is appropriate to assign a higher priority to LRT.⁽⁹⁾

The LRT-specific MUTCD provisions are provided in Sections 8A.01 (Introduction), 8A.03 (Use of Standard Devices, Systems, and Practices), 8B.05 (STOP and YIELD signs), 8C.03 (Flashing-Light Signals), 8C.05 (Automatic Gates) and 8C.10 (Traffic Control Signals at or Near Highway-LRT Grade Crossings), 8C.11 (Use of Traffic Control Signals for Control of LRT Vehicles), and 8C.13 (Pedestrian and Bicycle Signals). Key requirements are as follows:

- Section 8A.03 requires that Highway-LRT grade crossings in semi-exclusive alignments shall be equipped with a combination of automatic gates and flashing-light signals, or flashing-light signals only, or traffic control signals, unless an engineering study indicates that the use of Crossbuck Assemblies, STOP signs, or YIELD signs alone would be adequate.
- Section 8B.03 and 8B.04 contain provisions regarding the use and placement of Crossbuck signs and Crossbuck Assemblies. Section 8B.05 describes the appropriate conditions for the use of STOP or YIELD signs alone at a highway-LRT grade crossing. Sections 8C.10 and 8C.11 contain provisions regarding the use of traffic control signals at highway-LRT grade crossings.
- Section 8C.05 has various provisions depending upon the alignment, LRT speeds, and traffic conditions which can be summarized as follows:

- Where LRT speeds exceed 35 mph, highway-LRT crossings “should” be equipped with automatic gates and flashing-light signals.
- At LRT crossings “within highway-highway intersections” where LRT speeds do not exceed 35 mph, traffic control signals may be used instead of automatic gates.
- Where LRT speeds exceed 25 mph and a highway-LRT crossing is at a location “other than an intersection,” automatic gates and flashing-light signals “may” be installed (but are not required).
- At LRT crossings “other than an intersection” where the roadway is a low-volume street where prevailing speeds do not exceed 25 mph and where LRT speeds do not exceed 25 mph, traffic control signals or flashing-light signals without automatic gates “may” be used.

For additional information, reference the MUTCD (2009) Section 8A.03, Use of Standard Devices, Systems, and Practices at Highway-LRT Crossings.

Control of Motor Vehicle Turning Treatments

Motor vehicles making illegal turns in front of approaching light-rail vehicles (LRV) are one of the most common types of collision for most LRT systems.⁽³³⁾ Moreover, when such a collision occurs, the door of the motor vehicle is the only protection between the driver/passenger and the LRV, which makes turning collisions one of the most severe types of collisions between motor vehicles and LRVs. Traffic control devices that regulate turns are critical to LRT and general traffic safety. Current practice is to provide dedicated turn lanes for traffic turning toward the LRT crossing where practicable with traffic control signal indications for such movements.

Where turning traffic crosses a non-gated, semi-exclusive LRT alignment and is controlled by left- or right-turn arrow signal indications, Transit Cooperative Research Program (TCRP) Report 17 recommends that the LRT agency install an LRV-activated, flashing, internally illuminated warning sign displaying the front view LRV symbol (W10-7) when the LRV approaches.⁽³⁴⁾ When such a sign is used, the turn arrow signal indication serves as the primary regulatory control device and the flashing, internally illuminated warning sign supplements it, warning motorists of the increased risk associated with violating the turn arrow signal indication. The MUTCD allows use of this sign at LRT crossings controlled by STOP signs or automatic gates.

Where turning traffic crosses a non-gated, semi-exclusive LRT alignment and is controlled by a STOP sign or signal without a turn arrow (such as a permissive left or right turn), TCRP Report 17 recommends that an LRV-activated, internally illuminated “NO LEFT/RIGHT TURN” (R3-2/R3-1) symbol sign be provided to restrict left or right turns when an LRV is approaching (see **Figure 46**).⁽³⁴⁾ Because these signs would serve as the primary control devices regulating turning movements, TCRP Report 17 recommends that two signs be provided for each parallel approach. The LRV-activated, internally illuminated sign displaying the legend NO LEFT/RIGHT TURN may be used as an alternate to the active, internally illuminated symbol sign.

PREFERRED



R3-1



R3-2

24" X 30" DIAMETER CIRCLE

COLORS

CIRCLE & DIAGONAL - RED (INTERNALLY ILLUMINATED)

ARROW - WHITE (INTERNALLY ILLUMINATED)

BACKGROUND - BLACK (NON-REFLECTIVE)

ALTERNATE



R3-1a



R3-2a

24" X 30"

COLORS

LEGEND - RED (INTERNALLY ILLUMINATED)

BACKGROUND - BLACK (NON-REFLECTIVE)

Figure 46. No Turns Internally Illuminated Signs

Table 6 summarizes the recommended practices for the active, internally illuminated “NO LEFT/RIGHT TURN” symbol sign (regulatory) and the flashing, internally illuminated “TRAIN APPROACHING” sign (warning) for median or side-running LRT alignments where parallel traffic may proceed during LRV movements.

Table 6. Use of Active Internally Illuminated Signs for Parallel Traffic Turning Across LRT Tracks

Alignment Type	Intersection Traffic Control Device	“NO LEFT/RIGHT TURN ACROSS TRACKS” Sign	Train Icon Sign for Left/Right Turns ^a
Semi-exclusive gated	Stop ^c	Recommended	May
	Traffic signal without arrow ^d	Recommended ^b	May
	Traffic signal with arrow ^e	Not recommended	May
Semi-exclusive non-gated	Stop ^c	Recommended	May
	Traffic signal without arrow ^d	Recommended ^b	May
	Traffic signal with arrow ^e	Not recommended	Recommended

^a Left-turn signs are for median and side-aligned LRT alignments; right-turn signs are for side-aligned LRT alignments only.

^b Alternatively, an all-red phase for motor vehicles and pedestrians may be used in combination with “No Turn On Red” (R10-11a) signs.

^c “Stop” refers to a STOP sign-controlled intersection.

^d “Without arrow” refers to a signalized intersection at which the turning traffic has no red arrow displayed when an LRV is approaching but has either a steady green ball, a red ball, or a flashing red ball displayed.

^e “With arrow” refers to a signalized intersection at which the turning traffic has a red arrow displayed when an LRV is approaching.

When a turn arrow traffic signal indication is used, TCRP Report 17 recommends that an exclusive turn lane be provided.

































Source: Adapted from Korve, Hans W., Jose I. Farran, Douglas M. Mansel, et al. Integration of Light Rail Transit into City Streets, Washington, DC, TRCP Report 17, TRB, 1996.

For semi-exclusive alignments, all traffic conflicting with LRV movements at intersections and crossings should be positively controlled through use of turn pockets, traffic signals, and active warning signs.

LRT Bar Signals

The MUTCD Section 8C.11 provides the following guidance for use of LRT signals (refer to **Figure 47**):

- LRT movements in semi-exclusive alignments at non-gated crossings that are equipped with traffic control signals should be controlled with LRT Bar Signals.
- LRT signals that are used to control LRT movements only should display the signal indications illustrated in MUTCD Figure 8C-3.
- Standard traffic control signal indications may be used instead of LRT signals to control the movement of LRT vehicles (see Section 8C.10).
- Note that Section 4D.27 contains information about the use of LRT signals for the control of exclusive bus movements at “queue jumper lanes” and for the control of exclusive bus rapid transit movements on semi-exclusive or mixed-use alignments.

	Three-Lens Signal	Two-Lens Signal
<p>SINGLE LRT ROUTE</p> 	<p>STOP </p> <p>PREPARE TO STOP  Flashing</p> <p>GO </p>	<p>STOP </p> <p>GO ⁽²⁾</p>
<p>TWO LRT ROUTE DIVERSION</p> 	  Flashing   ⁽¹⁾	   ^{(1),(2)}
	  Flashing   ⁽¹⁾	   ^{(1),(2)}
<p>THREE LRT ROUTE DIVERSION</p> 	  Flashing    ⁽¹⁾	    ^{(1),(2)}

Notes:
 All aspects (or signal indications) are white.
 (1) Could be in single housing.
 (2) "Go" lens may be used in flashing mode to indicate "prepare to stop".

Figure 47. LRT Signals

Source: Manual on Uniform Traffic Control Devices, 2009 Edition, Figure 8C-3, Washington, DC, FHWA, 2009.

Pedestrian and Bicycle Signals at LRT Crossings

The MUTCD Section 8C.13 requires use of standard traffic control signal pedestrian signal heads compliant with Section 4E.04 where such heads are used at LRT crossings. Consistent with current practice, the MUTCD indicates flashing-light signals with a Crossbuck sign and audible device should be used where there is inadequate clearing sight distance ([refer to sight distance information in Chapter 2](#)), or where LRT speeds exceed 35 mph.

The MUTCD also allows use of the LOOK sign (R15-8) and/or pedestrian gates subject to an engineering study which indicates a flashing-light signal with Crossbuck would not be adequate. In addition, the MUTCD allows use of pedestrian “swing gates” as an option. Common practice includes use of swing gates in conjunction with pedestrian automatic gates where the swing gates can be used to provide a means of egress for users who are within the crossing zone when crossing gates are activated. (Refer to MUTCD Chapter 8D for additional swing gate provisions.)

PEDESTRIANS, BICYCLES, AND ACCESSIBILITY

This section presents material on non-motorized transportation or “active” transportation which is defined by the US Centers for Disease Control and Prevention as “any self-propelled, human-powered mode of transportation, such as walking or bicycling” as well as accessibility considerations and requirements associated with the “Americans with Disabilities Act of 1990” (ADA). PL 101-336, and the “ADA Amendments Act of 2008,” PL 110-325.”⁽³⁵⁾ Unless otherwise noted, the term “pedestrian” as used in this section refers to bicycles and other forms on non-motorized transportation in addition to pedestrians themselves.

Non-motorist crossing safety should be considered at all highway-rail crossings, particularly at or near commuter stations and at non-motorist facilities, such as bicycle/walking trails, pedestrian-only facilities, and pedestrian malls. Although collisions between trains and pedestrians occur less often than collisions between trains and motor vehicles, they are more severe. [Research Results Digest 84](#)⁽³⁶⁾, which studied pedestrian/LRV collisions, cites “risky or inattentive behavior” as a factor in pedestrian collisions and cites various contributing factors taken from the National Transit Database⁴ which were collaborated by transit agency staff:

- Rushing to catch trains or get across intersections
- Ignoring audible and/or visual warnings at crossings
- Distractions, such as cell phones and headsets
- Not paying attention in transit malls (usually involves little or no injury)
- Intoxication
- Trespassing⁽³⁶⁾

These behavioral factors can be exacerbated by the fact that LRVs—commuter trains operating in “push” mode—as well as conventional trains operating in designated Quiet Zones may be

⁴ <https://www.transit.dot.gov/ntd>

nearly silent approaching a crossing. For these reasons, appropriate pedestrian crossing control systems are critical for pedestrian safety.

It should be noted that injuries and fatalities (whether accidental or intentional as with suicides) also occur due to trespassing within the rail ROW; however, these topics are beyond the scope of this *Handbook*. Practitioners should consult other resources provided by the FRA, the Federal Transit Administration (FTA), and other sources including Operation Lifesaver Incorporated (OLI) for information and guidance on treatments which complement grade crossing treatments.

Pedestrian safety is enhanced when pathways and sidewalks are designed such that they cross the tracks as close to a right angle as practical. It is desirable that pathways and sidewalks be designed to maintain a relatively consistent horizontal alignment and profile of 12 feet from the nearest rail, the distance from the nearest rail to the detectable warning (if present), or the distance from the nearest rail to the stop line (if present), whichever is greater, on each approach to the crossing. Providing a pedestrian refuge area in advance of the stop line or detectable warning surface so pedestrians have a place to wait while rail traffic approaches and occupies the crossing can be beneficial to pedestrian safety. When designing new sidewalk crossings, placing the sidewalk outside of the area occupied by crossing traffic control devices for vehicular traffic is important. This includes making sure that the counterweights and support arms for the automatic gates for vehicular traffic do not obstruct the sidewalk when the gate is fully lowered.

Passive and active devices may be used to supplement highway-related active control devices to improve non-motorist safety at highway-rail crossings. Passive devices include fencing, swing gates, pedestrian barriers, detectable warning surfaces, pavement markings, texturing, refuge areas, and fixed message signs. Active devices include flashers, audible active control devices, automated pedestrian gates, pedestrian signals, variable message signs, and blank-out signs. These devices should be considered at crossings with high pedestrian traffic volumes, high train speeds or frequency, extremely wide crossings, complex highway-rail crossing geometry with complex ROW assignment, school zones, inadequate sight distance; and/or multiple tracks. All pedestrian facilities should be designed to minimize pedestrian crossing time, and devices should be designed to avoid trapping pedestrians between sets of tracks.

Channelization

The behavior of pedestrians crossing railroads is difficult to control. There are a variety of reasons pedestrians may disobey or ignore traffic control devices. Also, pedestrians often seek the shortest path and therefore may not always cross the tracks at the highway or designated pedestrian crossing. Pedestrian movements should be channelized to designated engineered crossing locations which provide warnings and controls designed for pedestrian use. Current practice used by commuter rail and transit extends fencing 50 to 100 feet back from designated pedestrian crossings to direct pedestrians to the crossing. Where fencing is used, the height should be reduced to 3.5 feet maximum within 100 feet of the crossing to avoid restricting sight distance.⁽³¹⁾ Alternatives to fencing less likely to impede sight distance include bollards or short posts with chains, or low landscaping.

Accessibility Standards

The ADA gives civil rights protections against discrimination to individuals with disabilities. It affords equal opportunity for individuals with disabilities in public accommodations, employment, transportation, State and local government services, and telecommunications. Titles II and III of the ADA include the enforceable accessibility standards called the 2010 ADA Standards for Accessible Design. The Department of Justice’s 2010 ADA Standards include standards for Accessible Routes. The Draft Proposed Right-of-Way Accessibility Guidelines (PROWAG) published by the United States Access Board, which were in rulemaking when this *Handbook* went to press, address many geometric features pertaining to pedestrian facilities, including the following:

- Minimum widths and clearances
- Accessible routes and pedestrian pathways
- Curb ramps and ramps
- Detectable warning strips
- Protruding objects

These standards are available from the Access Board website at <https://www.ada.gov/>.⁽³⁷⁾

MUTCD Provisions

The MUTCD presents provisions for LRT-pedestrian crossings in Sections 8C.13 and for “pathway” crossings in Section 8D. Pathways are defined in Section 1A.13 of the MUTCD as “a general term denoting a public way for purposes of travel by authorized users outside the traveled way and physically separated from the roadway by an open space or barrier and either within the highway right-of-way or within an independent alignment. Pathways include shared-use paths, but do not include sidewalks.” As such, pathways are distinguished from sidewalks which are considered part of the highway crossing. The FRA categorizes pedestrian crossings as either “pathway” or “station.” Practitioners should refer to MUTCD Section 8D for both “pathway” and “station” crossing treatments and provisions.

The MUTCD Section 8C.13 includes provisions for pedestrian and bicycle signals at LRT crossings. Although designated for LRT crossings, the guidance can be applied at conventional rail crossings such as those located along sidewalks. It should be noted that 8C.13 requires that pedestrian signal heads where used shall comply with the provisions of MUTCD Section 4E.04. Provisions for “pathway” crossings not associated with sidewalks are found in Section 8D of the MUTCD. However, as noted in 8D.01, many treatments outlined in Section 8D are applicable to crossings along sidewalks.

Current Practices

Current practices and guidance, some of which have been developed from LRT-crossing research, are shown in the following sections with references to MUTCD provisions and illustrative examples of various treatments.

Pedestrian Refuge Areas (Refer to MUTCD Section 8C.13)

- Where adjacent tracks are present, pedestrian movements should be designed to avoid having pedestrians wait between sets of tracks.
- Where a track crossing is immediately adjacent to a road in a semi-exclusive alignment, a pedestrian refuge area or island between the tracks and the road should be provided to permit pedestrians to stand clear of the tracks while waiting to cross the roadway. If there is insufficient area for a pedestrian refuge area or island between the tracks and the road, additional pedestrian signal heads, signing, and detectors (see MUTCD Section 4E.08) or flashing-light signals should be installed based on engineering judgement.

Pathway Crossing Signs and Markings (Refer to MUTCD Section 8D.03)

- Pathway grade crossing signs shall be standard in shape, legend, and color.
- The minimum mounting height for post-mounted signs adjacent to pathways and sidewalks shall be 4 feet, measured vertically from the bottom edge of the sign to the elevation of the near edge of the pathway or sidewalk surface.
- Where used at a pathway grade crossing, the traffic control device or its support shall be at least 2 feet laterally from the near edge of the pathway. Where traffic control devices are placed over a pathway or sidewalk, the vertical clearance shall be at least 8 feet for pathways.

Stop Lines and Edge Lines and Dynamic Envelope Markings (Refer to MUTCD Sections 8D.04, 3B.06 and 8B.29)

- If used at pathway crossings, the stop line should be a transverse line at the point where a pathway user is to stop. The stop line should be placed at least 2 feet farther from the nearest rail than the gate, counterweight flashing-light signal or Crossbuck assembly (if any of these are present) is placed, and at least 12 feet from the nearest rail.
- Edge lines (see Section 3B.06) may be used on approach to and across tracks to delineate the designated pathway user route.
- Refer to MUTCD Section 8B.29 for use of dynamic envelope markings. In an LRT/pedestrian mall, the dynamic envelope may be delineated in its entirety.⁽³⁴⁾

Recommended Practices for Stop Lines and Detectable Warnings

Detectable warning surfaces mark boundaries between pedestrian and vehicular ways where there is no raised curb. Detectable warning surfaces contrast visually with adjacent walking surfaces, either light-on-dark, or dark-on-light. Detectable warning surfaces are required by 49 CFR 37, Appendix A, 406.8 and by the ADA where curb ramps are constructed at the junction of sidewalks and the roadway, for marked and unmarked crosswalks. Proposed guidelines developed by the United States Access Board (R304.2.3) will require use of detectable warnings at all grade crossings whether along sidewalks or pathways located so that the edge nearest the rail crossing is 6 feet minimum and 15 feet maximum from the centerline of the nearest rail.⁽³⁷⁾ The March 2014 update by the Access Board provides recent information on the design and placement of detectable warning surfaces.⁽³⁸⁾

- A stop line should be provided at a pathway crossing if the surface where the marking is to be applied can retain the application of the marking
- Detectable warnings should be used at pathway crossings where pedestrian travel is permitted and at sidewalk crossings and should extend across the full width of the pathway or sidewalk
- Detectable warnings should be placed immediately in advance of the pathway or sidewalk stop line (if present)
- The near edge of the detectable warnings should be located no less than 12 feet from the nearest rail and be at least 2 feet in depth
- Where the distance between the center line of two tracks exceeds 38 feet, additional detectable warnings, designating the limits of a pedestrian refuge area, should be used at sidewalk or pathway crossings

Crossbuck Assemblies and Swing Gates (Refer to MUTCD 8D.05)

The MUTCD indicates a Crossbuck Assembly shall be installed on each approach to a pedestrian crossing except at station crossings and sidewalk crossings located within 25 feet of the traveled way. The MUTCD also contains provisions for use of swing gates which shall be designed to open away from the tracks and automatically return to the closed position. Use of swing gates should consider the crossing user's ability to detect the presence of approaching rail traffic. (ADA Accessibility Guidelines for Buildings and Facilities [ADAAG] contains information regarding spring hinges and gate opening forces.)

Active Traffic Control Devices (Refer to MUTCD 8D.06)

The MUTCD requires that flashing-light signals, where used at a pathway crossing, shall be provided for each direction and that a bell or other audible warning device shall be provided. The flashing red lights shall be aligned horizontally. Reduced-size lenses may be used at a lower height at pathway crossings, however, the units shall have a diameter of at least 4 inches and a minimum mounting height of 4 feet except where installed between tracks, in which case a minimum mounting height shall be 1 foot.

Current practice considers the following:

- Flashing-light signals, bell or audible warning device may be omitted at pathway or sidewalk crossings that are located within 25 feet of an active warning device at a crossing that is equipped with those devices.
- Additional pairs of flashing-light units, bell or audible warning devices may be installed on the active traffic control devices at a crossing from the back side of those devices.
- Pedestrian signal heads as described in Chapter 4E (of the MUTCD) utilizing Upraised Hand and Walking Person symbols should not be used at a pathway or sidewalk crossing except where a traffic control signal is used to control both rail and highway vehicles.

Pedestrian Automatic Gates (Refer to MUTCD 8D.06)

The MUTCD recommends that automatic gates used at pathway crossings should be a minimum of 2.5 feet and a maximum of 4 feet above the walkway, however, where a vehicular gate extends across a sidewalk, the location, placement and height prescribed for vehicular gates shall be used (see Section 8C.04.).

Current practice considers the following:

- When an automatic gate is used at a sidewalk crossing, a separate mechanism should be provided for the sidewalk gate, instead of a supplemental or auxiliary gate arm installed as a part of the same mechanism.
- If used at a pathway or sidewalk crossing, automatic gate arms should be provided with a minimum of one light as shown in MUTCD Figure 8C.6. This light should be continuously illuminated whenever the warning system is active.
- If used, additional lights on the automatic gate arm should be installed in pairs and flashed alternately in unison with other flashing-light units (see MUTCD Figures 8C.5 and 8C.6.).
- Where automatic pedestrian gates are installed across pathway or sidewalk crossings, an emergency escape route should be available to provide egress away from the track area when the gates are activated.
- An emergency exit route can be provided by use of a swing gate in combination with a pedestrian automatic gate. In this circumstance, the swing gate should be signed as an “Emergency Exit” on the track side and provided with a “DO NOT ENTER” (R5-1) sign on the side facing away from the tracks.
- If used at a pathway or sidewalk crossings, the gate configuration, which might include a combination of automatic pedestrian gates and swing gates, should provide for full-width coverage of the pathway or sidewalk on each approach to the crossing.

ILLUSTRATIVE EXAMPLES OF PEDESTRIAN TREATMENTS

This section provides examples of pedestrian treatments including diagrams shown in the MUTCD and photographs of applications. For additional examples of pedestrian treatments, refer to the FRA reports “Compilation of Pedestrian Safety Devices in Use at Grade Crossings”⁽³⁹⁾ and “Guidance on Pedestrian Safety at or Near Passenger Stations”⁽⁴⁰⁾

Pathway Crossing Signing and Markings for Bicyclists and Skaters

Crossings which serve higher-speed users such as bicyclists and skaters should use a combination of treatments including advance warning signs and pavement markings along with a Crossbuck Assembly and optional LOOK (R15-8) sign as shown in **Figure 48**.

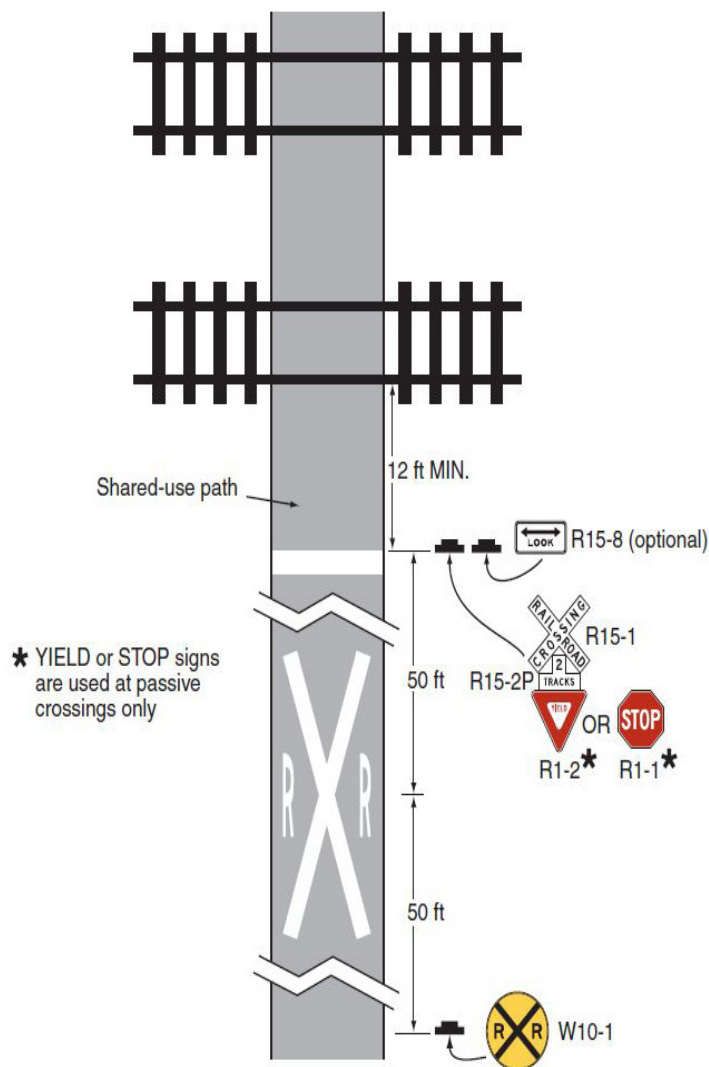

Figure 48. Example of Signing and Markings for a Pathway Crossing

Source: *Manual on Uniform Traffic Control Devices, 2009 Edition, Figure 8D-1, Washington, DC, FHWA, 2009.*

Dynamic Envelope Markings

As shown in **Figure 49**, ADA-compliant tactile warning strips have been used to delineate the dynamic envelope continuously through locations where pedestrians may cross the trackway. **Figure 50** shows a treatment which uses contrasting pavement to delineate the dynamic envelope through a crosswalk.

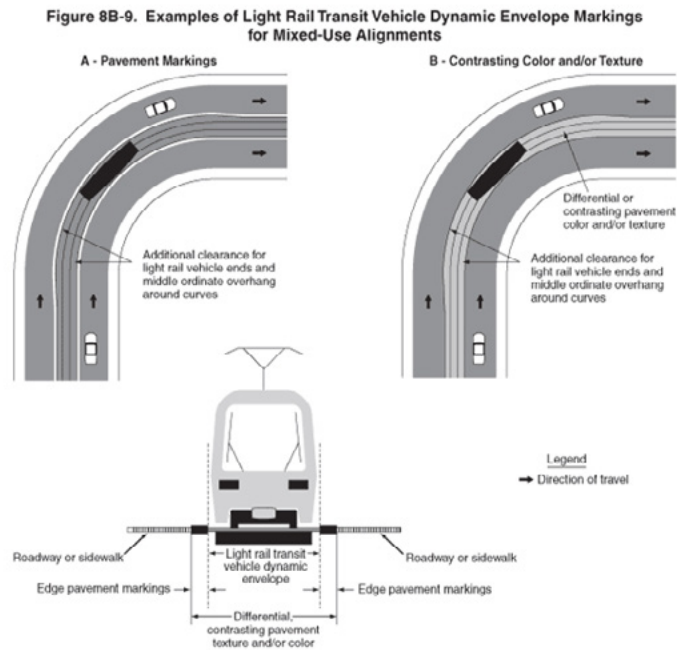

Figure 49. Illustrative Example of an ADA Dynamic Envelope Delineation

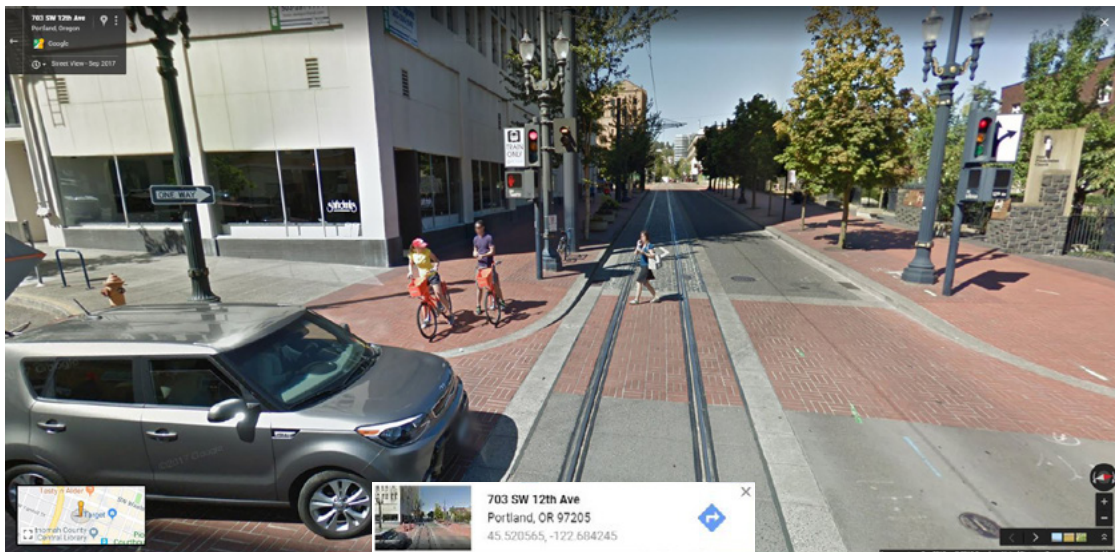

Figure 50. Illustrative Example of Dynamic Envelope Delineation through a Pedestrian Crosswalk (Portland TriMet, Morrison Street, Portland, Oregon)

Source: Google Earth V 7.1.7.2602. (September 6, 2016). Morrison St near 12th Ave, Portland, Oregon, USA. 45°31'14.06"N, 122°41'01.87"W, Eye alt eye level. DirectX 2016. Google Earth Pro. [January 30, 2019].

Pedestrian Barriers

Pedestrian barriers may be placed in an offset pattern to create a “maze” which forces pedestrians to turn and look both ways approaching a sidewalk crossing, especially in tight urban spaces where there is no fenced-in ROW, such as a pedestrian crossing at a street intersection. These barriers can also incorporate a pedestrian refuge zone between the trackway and an adjacent roadway. **Figure 51** and **Figure 52** show a diagram from the MUTCD as well as an in-situ application from Calgary, Alberta.

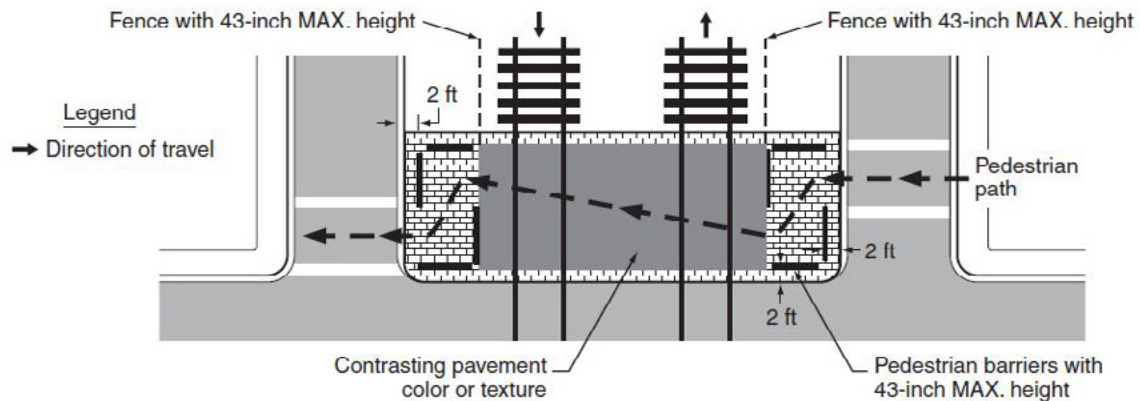

Figure 51. Diagram Depicting Use of Pedestrian Barriers

Source: Manual on Uniform Traffic Control Devices, 2009 Edition, Section 8C.13 Figure 8C-9, Washington, DC, FHWA, 2009.



Figure 52. Illustrative Example of a Pedestrian Barrier Application (BNSF Cotton Crossing. Peoria, AZ USDOT 025405Y)

Source: FHWA.

Pedestrian barriers are less effective where trains operate in both directions in single or double-track territory because pedestrians may be looking the wrong way in some instances. Where fencing is installed to direct path or sidewalk users to the pathway or sidewalk crossing, it is desirable that this fencing be connected to any continuous existing or new fencing or channelization that has been installed parallel to the track(s) to discourage pedestrians from circumventing the crossing. Pedestrian barriers should be designed to permit the passage of wheelchairs and power-assisted mobility devices, and if bicycles are permitted, to permit the passage of dismounted bicyclist with tandem bicycles or bicycles with trailers.

Z-crossing Channelization

Similar in function to a maze created with pedestrian barriers, a “Z-crossing” is designed to turn pedestrians toward approaching trains, forcing them to look in the direction of oncoming rail vehicles. **Figure 53** and **Figure 54** show a diagram from the MUTCD as well as an application from Portland, Oregon. Z-crossing channelization may be used at pathway crossings where pedestrians are likely to run unimpeded across the tracks, such as isolated, midblock, pedestrian-only crossings, particularly where there is good stopping sight distance and pedestrian volumes are low and active devices are not required. Standard configuration Z-crossings are not suitable for single- or double-track locations where trains operate in both directions on a regular basis. The angled crossing configuration can be adapted by extending the length of the diagonal zone so users face both directions while traversing the crossing but angled crossings are more difficult for wheelchairs and bicycles to navigate.

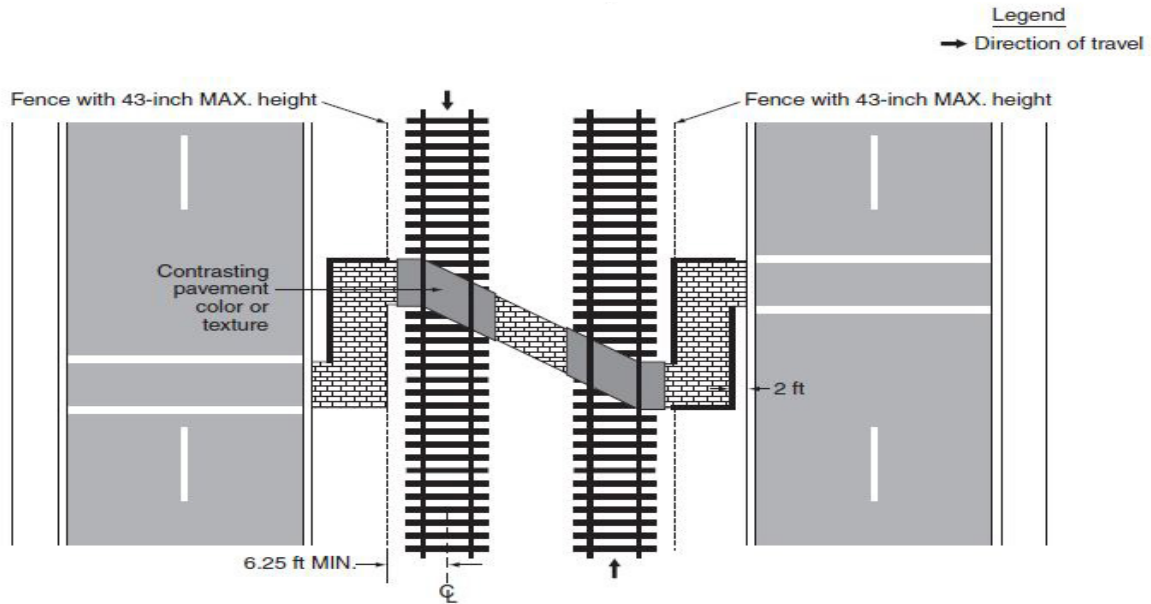

Figure 53. Illustrative Example of a Z-Crossing Diagrammatic Plan for an In-Situ Application in Portland, Oregon

Source: Manual on Uniform Traffic Control Devices, 2009 Edition, Section 8C.13 Figure 8C-10, Washington, DC, FHWA, 2009.



Figure 54. Illustrative Example of a Z-Crossing (Portland TriMet, Burnside Avenue, Portland, OR)

Source: Google Earth V 7.1.7.2602. (September 6, 2016). Burnside near E 176th Ave, Portland, Oregon, USA. 451°31'19.06"N, 122°28'54.69"W, Eye alt eye level. DirectX 2016. Google Earth Pro. [July 18, 2018].

Swing Gates

The swing gate (sometimes used in conjunction with flashing-lights and bells) alerts pedestrians to the presence of tracks and causes them to pause before crossing. This restriction of movement encourages pedestrians to assess the crossings' surroundings and approaching rail traffic. The swing gate requires pedestrians to pull the gate to enter the crossing and push the gate to exit the protected track area; therefore, a pedestrian cannot physically cross the track area without pulling and opening the gate. **Figure 55** shows how swing gates may be used to control a pedestrian crossing within a station area for movement between platforms.

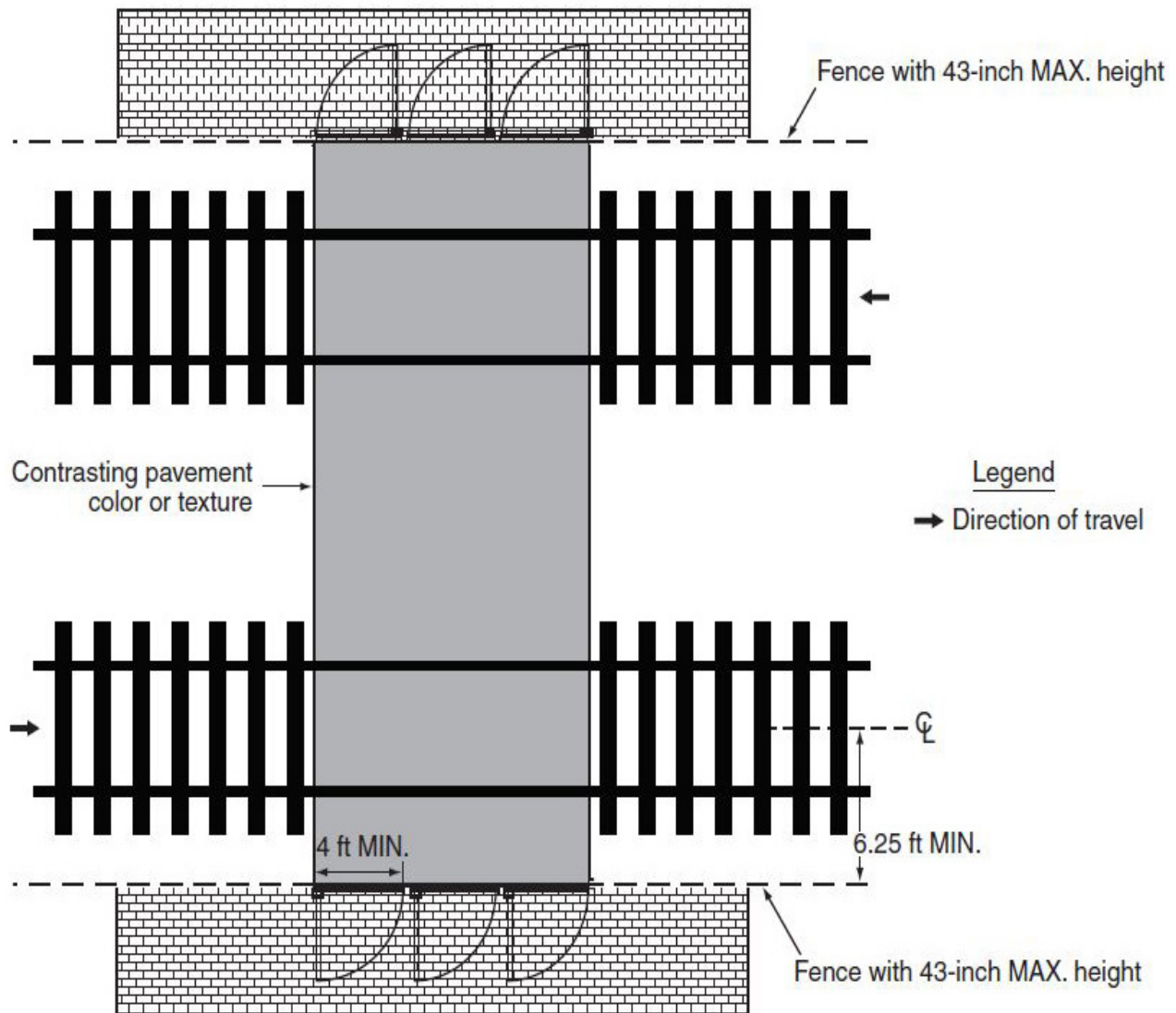

Figure 55. Diagrammatic Plan of a Swing Gate

Source: Manual on Uniform Traffic Control Devices, 2009 Edition, Section 8C.13 Figure 8C-8, Washington, DC, FHWA, 2009.

Alternatively, a swing gate may be used as an exit gate from a crossing area which is controlled by pedestrian automatic gates. When used in this manner, the gate should be provided with a sign facing users within the crossing that it is provided as an “emergency exit” as well as with a “DO NOT ENTER” (R5-1) sign facing users approaching the crossing. **Figure 56** shows an in-situ example.

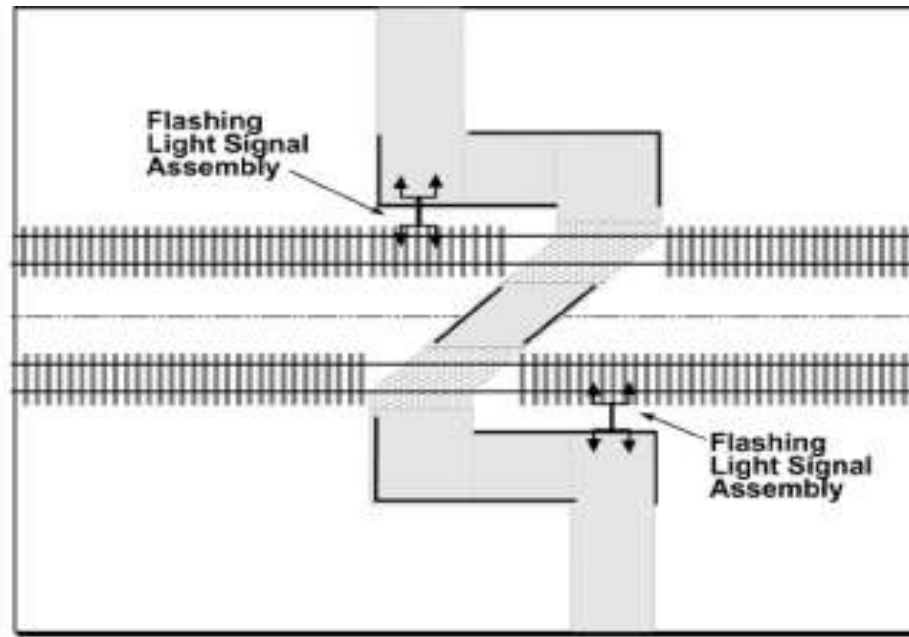

Figure 56. Illustrative Example of Pedestrian Automatic Gate with Swing Gate

Source: Brian Gilleran, Federal Railroad Administration.

Flashing-Light Signals

At pedestrian crossings where engineering study indicates the need to provide active warning, the flashing-light signal assembly can be provided. Flashing-light signals should be used in conjunction with a crossing bell or audible device and may be used either at pathway crossings as shown in **Figure 57**, Option A, or in quadrants opposite road gates as shown in Option B. When the red lenses of the flashing-light signal are flashing alternately and the audible device of the flashing-light signal is active, the pedestrian is required to remain clear of the tracks (Uniform Vehicle Code, Section 11-513).⁽⁹⁾ A Crossbuck Assembly with the standard Crossbuck sign (R15-1) and, where there is more than one track, an auxiliary inverted T-shaped sign indicating the number of tracks (R15-2) should be used in conjunction with the flashing-light device.



OPTION A

(Unsignalized pedestrian-only crossing without pedestrian automatic gates)

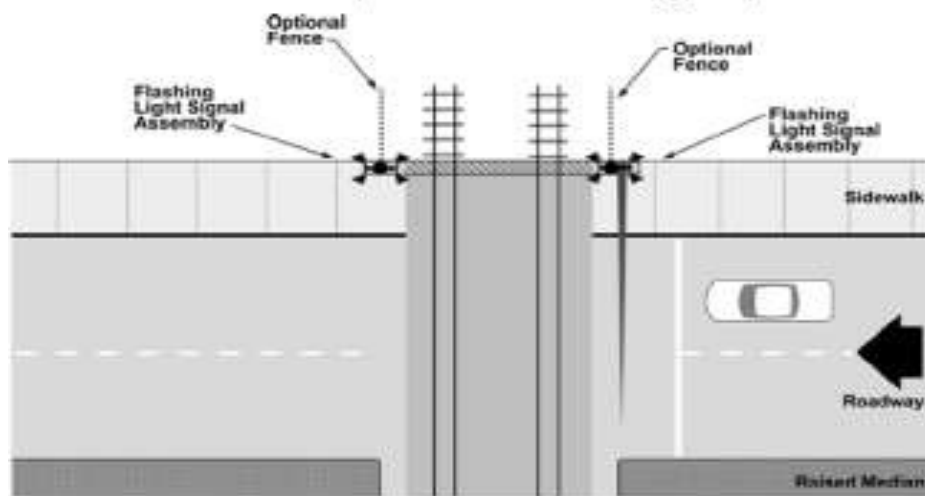

OPTION B

(Off-quadrant of gated crossings without pedestrian automatic gates)

Figure 57. Flashing-Light Signal Placement Options

Source: Korve, Hans W., Jose I. Farran, Douglas M. Mansel, et al. Integration of Light Rail Transit into City Streets, Transit Cooperative Research Report 17, Transportation Research Board, Washington, DC, 1996.

Pedestrian Automatic Gates

Pedestrian automatic gates are the same as standard automatic crossing gates except the gate arms are shorter. When activated by an approaching train, the automatic gates are used to physically prevent pedestrians from crossing the tracks. The “TCRP Report 17,” which evaluated LRT crossings, recommends this type of gate be used in areas where pedestrian risk of a collision as determined by engineering study is medium to high (for example, where stopping sight distance is inadequate and pedestrian volume is significant).⁽³⁴⁾

The preferred method is to provide pedestrian automatic gates in all four quadrants, either using separate pedestrian gates or with a combination of pedestrian gates and vehicular gates extending across the sidewalk as shown in **Figure 58**. Where ROW conditions permit, the vehicle automatic gate may be located behind the sidewalk on the back side away from the curb, so that the arm will extend across the sidewalk, blocking the pedestrian way (see top illustration in Figure 58). Longer and lighter gate arms make this installation feasible; however, experience suggests a maximum gate arm length of 38 feet for practical operation and maintenance. At crossings requiring the gate arm to be longer than 38 feet, a second automatic gate could be placed in the roadway median, or a separate pedestrian gate could be used as shown in the bottom illustration of **Figure 58**. Note that the effective coverage is less than 38 feet due to setback requirements and the size of the gate mechanism.

It should be noted that pedestrians can be trapped behind the crossing gate when there is full closure. In principle, the minimum setback of 12 feet provides a refuge zone between the gate and dynamic envelope. However, to avoid potential panic, current practice uses a separate swing gate, as a designated emergency exit, where crossing gates would completely enclose the crossing (see **Figure 56**).

Crossing Gate Skirt

Crossing gate “skirts” which may be constructed by attaching a horizontal hanging bar to the gate arm have been shown to be effective at reducing the likelihood that pedestrians will violate a lowered crossing gate.⁽⁴¹⁾ Crossing gate skirts were installed along the Dallas LRT system at sidewalk approaches to an elementary school to reduce the likelihood that children would duck under the gates while walking to school. **Figure 59** and **Figure 60** show a gate deployed at the Lynn Haven Avenue crossing in Dallas, Texas.

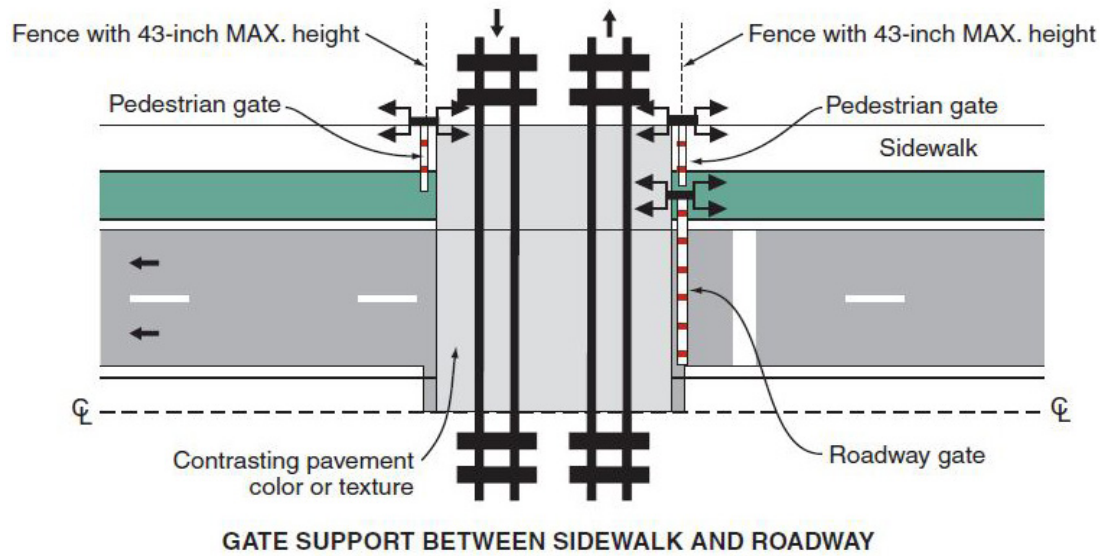
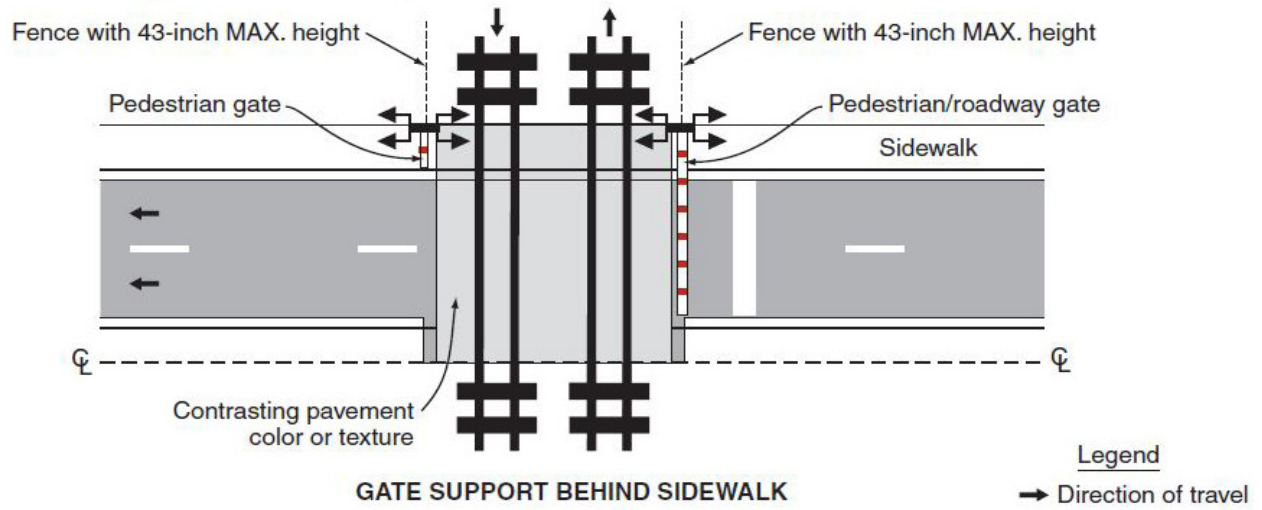

Figure 58. Examples of Placement of Pedestrian Gates

Source: Manual on Uniform Traffic Control Devices, 2009 Edition, Section 8C.13 Figure 8C-7, Washington, DC: FHWA, 2009.

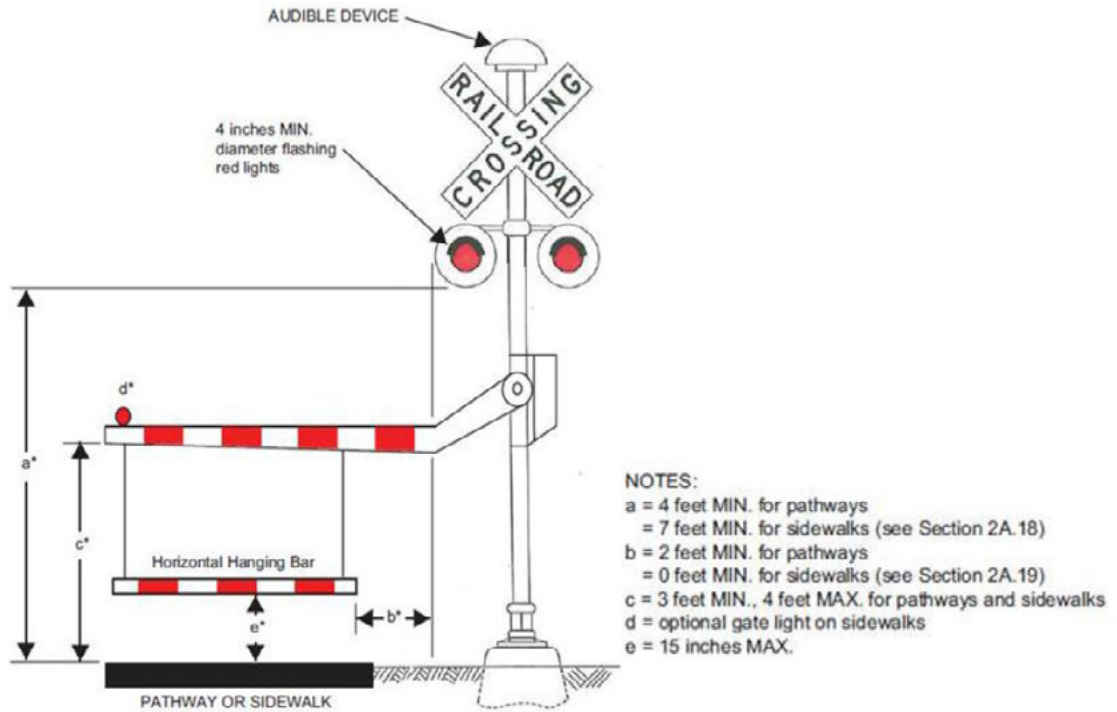

Figure 59. Diagrammatic Example of Pedestrian Gate with Skirt

Source: Gabree, S & Chase, Stephanie & daSilva, Marco. Effect of Gate Skirts on Pedestrian Behavior at Highway-Rail Grade Crossings, FRA, Washington, DC, 2013.



Figure 60. Illustrative Example of Pedestrian Gate with Skirt (DART Blue Line Lynn Haven Avenue Crossing, Dallas, TX)

Source: Brent Ogden.

CHAPTER 3. TREATMENT SELECTION GUIDANCE

This chapter discusses methods for selecting alternatives and provides information on MUTCD Interpretations, Experimentation, Changes, and Interim Approvals, which provide the best source of new guidance between updates to the MUTCD.

Methods to evaluate and select alternatives through engineering study and economic analysis techniques which are presented include the following:

- Updated “Technical Working Group” (TWG) Guidance
- Field Diagnostic Team Review Procedure
- Benefit-Cost Analysis
- Resource Allocation Procedure
- FRA GradeDec Software

Although procedures are provided for developing benefit-cost analyses of alternative treatments, more recent trends place emphasis on risk avoidance and best practices. As a result, benefit-cost studies may only be useful for evaluating alternatives that involve a major investment. In addition, the Rail-Highway Crossing Resource Allocation Procedure is presented and other low-cost solutions are discussed.

More involved economic analyses such as Benefit-Cost Analysis, Resource Allocation Procedures, and use of GradeDec may be more appropriate approaches to utilize when looking at multi-crossing scenarios, such as rail corridors or statewide efforts, or when considering trade-offs between at-grade improvements vs. closures and grade separations.

The Technical Working Group TWG guidance, which relies upon readily available planning data, can provide a good initial approach.

Confirmation of treatments should include a field review using the Diagnostic Team Review procedure.

TECHNICAL WORKING GROUP GUIDANCE

Following the 1995 collision in Fox River Grove, IL, between a Metra commuter train and a school bus, which resulted in the deaths of seven students, the USDOT established a Technical Working Group (TWG) to develop “best practices” guidance on a selection of crossing treatments. The TWG included representatives from the FHWA, FRA, FTA, and NHTSA, along with traffic engineers and rail signaling engineers with a working knowledge of crossing treatments. The cooperation among the various representatives of the TWG represented a landmark interdisciplinary effort to enhance communication among railroad companies and governmental agencies involved in enhancing grade crossing safety.

Note: This document summarizes current practices but does not set standards; practitioners are advised to check current local standards and requirements (refer to Disclaimer and Quality Assurance Statement). Users of the data provided within this document should anticipate possible variations from current information within the FRA databases, which are updated monthly.

The guidance developed by the TWG notes that a highway-rail crossing differs from a highway-highway intersection in that the train always has the ROW. From this perspective, the TWG highlights key considerations for deciding what type of highway traffic control device(s) are to be installed, if in fact a grade crossing should be allowed to remain. This, in turn, requires an assessment of what information the road user (specifically non-motorized system users) needs to be able to cross safely and whether the resulting driver response to a traffic control device is “compatible” with the intended function of the highway and railroad facility. The TWG guidance outlines the role of stopping sight distance, approach (corner) sight distance, and clearing sight distance, and integrates this with highway system needs based upon the type and classification of the roadway as well as the allowable track speeds by class of track for the railway system.

The TWG guidance provided in this *Handbook* has been updated to reflect current practice. It is intended to assist engineers in the selection of traffic control devices or other measures at highway-rail crossings. It is not to be interpreted as policy or standards and is not mandatory. Any requirements that may be noted are taken from the MUTCD or other standards. A number of measures are included which may not have been supported by quantitative research but are being used by States and local agencies. This TWG guidance is for information purposes only.

Minimum Devices: All highway-rail crossings, including street-running railroads or transit systems on public streets or highways should be equipped with approved passive warning devices, as shown in MUTCD Part 8.

Minimum Widths: All highway-rail crossing surfaces should extend a minimum of 1 foot beyond the edge of the roadway shoulder, sidewalk, pathway or face of curb, as measured perpendicular to the roadway centerline.

Closure: Highway-rail crossings should be considered for closure and physically removed from the railroad right-of-way whenever one or more of the following apply:

- An engineering study determines a nearby crossing otherwise required to be improved or grade separated already provides acceptable alternate vehicular and pedestrian access
- If an engineering study determines any of the following apply:
 - Average Annual Daily Traffic (AADT) less than 1,000
 - Acceptable alternate access across the rail line exists within one (1) mile measured along the track
 - The median trip length normally made over the subject crossing would not increase by more than 2.5 miles
- If railroad operations will occupy or block the crossing for extended periods of time on a routine basis and it is determined that it is not physically or economically feasible to either construct a grade separation or shift the train operation to another location, and an engineering study determines that such a crossing should be closed to vehicular and pedestrian traffic. Such locations would typically include the following:
 - In or adjacent to rail yards and locations near industrial spur tracks where trains pick up or set out blocks of cars or switch local industries
 - Passing tracks primarily used for holding trains while waiting to meet or be passed by other trains
 - Locations where train crews are routinely required to stop for crew changes or for cross traffic on intersecting rail lines
 - In the proximity of stations where trains dwell for extended periods of time and block the crossing

It may be advisable to investigate whether to construct alternative roadway access in conjunction with closing the crossing when the subject crossing is currently the only access to a community.

Grade Separation: Grade separation should be provided at all limited access facilities and should be considered for whenever one or more of the following conditions exist:

- The posted highway speed equals or exceeds 55 mph
- AADT exceeds 30,000 in urban areas or 20,000 in rural areas
- Maximum authorized train speed exceeds 79 mph
- An average of 30 or more trains per day
- An average of 75 or more passenger trains per day in urban areas or 30 or more passenger trains per day in rural areas
- An average of 150 or more transit trains per day in urban areas or 60 or more passenger trains per day in rural areas
- Freight Train Crossing Exposure (the product of the number of trains per day and AADT) exceeds 900,000 in urban areas or 600,000 in rural areas
- Passenger Train Crossing Exposure (the product of the number of passenger trains per day and AADT) exceeds 2,250,000 in urban areas or 600,000 in rural areas
- Transit Train Crossing Exposure (the product of the number of transit trains per day and AADT) exceeds 4,500,000 in urban areas or 1,200,000 in rural areas
- The expected accident frequency for active devices with gates, as calculated by the USDOT Accident Prediction Formula including five-year accident history, exceeds 0.5 (per year). If the highway is a part of the designated National Highway System, the expected accident frequency for active devices with gates, as calculated by the USDOT Accident Prediction Formula including five-year accident history, exceeds 0.2 (per year)
- Vehicle delay exceeds 30 vehicle hours per day with consideration for cost effectiveness
- Whenever a new grade separation is constructed, whether or not it replaces an existing highway-rail crossing, consideration should be given to the possibility of closing one or more adjacent crossings. In addition, the railroad should be consulted prior to starting design to determine the railroad's future clear span requirements for the tracks crossed
- Utilize **Table 7** for LRT grade separations

Table 7. LRT Grade Separation

Trains Per Hour	Peak-Hour Volume (Vehicles Per Lane)
60	200
40	400
20	600

Source: Light Rail Transit Grade Separation Guidelines, An Informational Report. Washington, DC, ITE, Technical Committee 6A-42, March 1992.

PASSIVE WARNING DEVICES

- A circular railroad advance warning (W10-1) sign shall be used on each roadway in advance of every highway-rail crossing except as described in MUTCD Section 8B.06.
- If a Yield Ahead or Stop Ahead sign is to be installed on the approach to the crossing, the W10-1 sign should be installed upstream (further from the track) from the Yield Ahead or Stop Ahead sign.
- Except for crossings located within railroad yards or port and dock facilities, FRA regulations (49 CFR 234.311) require the installation of Emergency Notification System signs at highway-rail and pathway grade crossings, to provide information to road users so that they can notify the railroad company about unsafe conditions or malfunctioning active crossing warning devices.
- Where the roadway approaches to the crossing are paved, pavement markings are to be installed as described in MUTCD, subject to engineering evaluation.
- Where applicable, the “TRACKS OUT OF SERVICE” sign may be used to notify drivers that the tracks have been temporarily or permanently abandoned, but only until the tracks have been paved over or removed from the crossing.
- MUTCD Section 8B.04 discusses Crossbuck Assemblies, where one reflectorized Crossbuck sign and either a Yield sign or a Stop sign shall be used on each roadway approach to a highway-rail crossing.
 - If there are two or more tracks, the number of tracks should be indicated on a supplemental sign (R15-2) of inverted T shape mounted below the Crossbuck.
 - Strips of retroreflective white or red should be installed on the sign posts in accordance with MUTCD.

ACTIVE WARNING DEVICES

If active devices are selected, railroad flashers with gates may be appropriate if the following conditions exist:

- Inadequate sight distance exists in one or more approach quadrants and it is not physically or economically feasible to correct the sight distance deficiency
- Regularly scheduled passenger trains operate near industrial facilities, such as stone quarries, log mills, cement plants, steel mills, oil refineries, chemical plants, and landfills
- Near schools, industrial plants, or commercial areas where there is substantially higher than normal usage by school buses, heavy trucks, or trucks carrying dangerous or hazardous materials
- Near a highway intersection or other highway-rail crossings and the traffic control devices at the nearby intersection cause traffic to queue on or across the tracks (in such instances, if a nearby intersection has traffic signal control, it should be interconnected to provide preempted operation, and traffic signal control should be considered if none)
- The crossing is in a rural area with tangent approaches that extend more than a mile and the speed limit equals or exceeds 55 mph
- Multiple tracks exist at or in the immediate crossing vicinity where the presence of a moving or standing train on one track effectively reduces the visibility of another train approaching the crossing on an adjacent track (absent some other acceptable means of warning drivers to be alert for the possibility of a second train)
- An average of 20 or more trains per day
- Posted highway speed equals or exceeds 40 mph in urban areas or equals or exceeds 55 mph in rural areas
- AADT exceeds 2,000 in urban areas or 500 in rural areas
- Multiple lanes of traffic in the same direction of travel (usually this will include cantilevered signals)
- The crossing exposure (the product of the number of trains per day and AADT) exceeds 5,000 in urban areas or 4,000 in rural areas
- As otherwise recommended by an engineering study or diagnostic team

If active devices are selected, a preempted traffic control signal without railroad warning devices may be appropriate if the following conditions exist:

- The crossing is located through the center of a roadway intersection. Typically, the traffic signals will be preempted and will hold in a dwell phase showing a red traffic control signal indication to all cross-track traffic. The traffic control signal should include battery backup power. Additional flashing-lights are not necessary if the traffic control signal will be controlling roadway traffic on and around the railroad track crossing.
- The crossing is located along the shoulder of the roadway that is parallel to the track and there is little to no storage for a design vehicle. Consideration should always be given to school bus use and truck traffic. If a traffic control signal is installed at the adjacent roadway intersection, the stop line should be placed on the opposite side of the track from the roadway intersection and the traffic control signal should be installed and operate in a manner that routinely stops vehicles before they enter the track area.

If active devices are selected, railroad flashers without gates may be appropriate if the following conditions exist:

- The crossing is located through the center of a roadway intersection. Typically, the traffic signals will need to be preempted and will hold in a dwell phase showing a red traffic control signal indication to cross-track traffic. The traffic control signal should have battery backup power.
- The crossing is located near a yard or multi-track location where frequent switching operations may occur within the approach circuit. Installation of gates may promote gate runner behavior if motorists frequently observe active devices operating with trains that do not cross the crossing. The use of flashing-lights alone requires the driver to stop and assess the situation before proceeding.
- The crossing is located on an industrial lead or spur track. Train operations through industrial areas where multiple turnouts leading to multiple dead-end tracks tend to be slow—near walking speed. As operations often necessitate stopping/switching in these areas, gate installation prevents motorists from stopping and proceeding during operations where the train will not cross into the roadway.
- The crossing is located next to an industry gate access. In these locations, train operations often require the train to pull near the gate slowly and stop so a train crew member can get off the train and unlock the gate before the train can proceed.

Roadway Realignment: In some circumstances, a crossing may have adverse geometric features which can be improved by realignment of the roadway. Examples include the following:

- Skew Angle Crossings
- Crossings with Adverse Profile due to roadway constraints
- Crossings on an approach to a multi-leg intersection
- Adjacent crossings which are on approaches to closely-spaced intersections
- Crossings with extremely poor corner sight distance
- Crossings at locations subject to recurrent queuing which cannot be cleared with typical treatments
- Crossings at locations near rail junctions subject to frequent blockage or switching activity

New Crossings: New highway-rail crossings should only be permitted when the following can be demonstrated:

- Where there is a clear and compelling public need (other than enhancing the value or development potential of the adjoining property for new highways or streets)
- Grade separation cannot be economically justified, i.e., benefit-to-cost ratio on a fully allocated cost basis is less than 1.0 (when the crossing exposure exceeds 50,000 in urban areas or exceeds 25,000 in rural areas)
- There are no other viable alternatives to provide access

If a crossing is permitted, the following conditions should apply:

- Whenever a new highway-rail crossing is constructed, consideration should be given to closing one or more adjacent crossings
- If it is a main track, the crossing should be equipped with active devices with gates
- The plans and specifications should be subject to the approval of the highway agency having jurisdiction over the roadway (if other than a State agency), the State department of transportation or other State agency vested with the authority to approve new crossings, and the operating railroad
- All costs associated with the construction of the new crossing should be borne by the party or parties requesting the new crossing, including providing financially for the ongoing maintenance of the crossing surface and traffic control devices where no crossing closures are included in the project
- Whenever new public highway-rail crossings are permitted, they should fully comply with all applicable provisions of this proposed recommended practice

Traffic Control Device Selection Procedure:

Step 1—Minimum highway-rail crossing criteria:

1. Gather preliminary crossing data:

Highway:

- Geometric configuration (number of approach lanes, alignment, median)
- AADT
- Speed (posted limit or operating)
- Functional classification
- Desired Level of Service (LOS)
- Proximity of other intersections (note active device interconnection)
- Availability and proximity of alternate routes and/or crossings
- Emergency response facilities
- Type of vehicle usage (trucks, buses, etc.)
- Stop line locations and storage distances

Railroad:

- Number of tracks (type: FRA classification, mainline, siding, spur)
- Number of trains (passenger, freight, other)
- Timetable track speed and operational characteristics
- Proximity of rail yards, stations, terminals, spurs, and railroad wayside equipment (defect detectors, train signals, etc.)
- Crossing signal control circuitry

Traffic Control Device:

- Passive or active
- Existence of traffic signal(s) and preemption
- Road approach traffic control signal timing (coordinated or uncoordinated)
- Supplemental devices (approach warning beacons, supplemental flashers, etc.)

Prior Collision History

2. Based on one or more of the above, determine whether any of the recommended thresholds for closure, installing passive or active devices, or grade separation have been met based on highway or rail system operational requirements
3. Consider crossing closure based on the criteria noted earlier in this section

Step 2—Evaluate highway traffic flow characteristics:

1. Consider the required motorist response to the existing (or proposed) type of traffic control device. At passive crossings, determine the degree to which traffic may need to slow or stop based on evaluation of available corner sight distances
2. Determine whether the existing (or proposed) type of traffic control device and railroad operations will allow highway traffic to perform at an acceptable LOS for the functional classification of the highway

Step 3—Possible revision to the highway-rail crossing:

1. If crossing closure or consolidation is being considered, determine the feasibility and cost of providing of an acceptable alternate route and compare this to the feasibility, benefits of safety modifications and cost of improving the existing crossing
2. If grade separation is being considered:
 - Economic analysis should consider fully allocated life-cycle costs
 - Consider highway classification and LOS
 - Consider the possibility of closing one or more adjacent crossings
 - Consider future traffic generation from population growth
3. If there is inadequate sight distance related to the type of control device for stopping, approach speed, or clearing, consider measures such as:
 - Trying to correct the sight distance limitation
 - Closing the crossing
 - Grade separating the crossing
 - Performing an engineering study to determine the need for a STOP sign in lieu of the required YIELD sign at the crossing
 - Performing an engineering study to determine the safe approach speed and consider either posting an advisory speed plaque at the advance warning sign or reduce the regulatory speed limit on the approach
 - Upgrading a passive or flashing-light-only traffic control device to active with gates
4. If active devices are being considered, the devices should be installed with consideration to what is discussed earlier in this section

PEDESTRIAN TREATMENTS

The following discussion draws upon the research found in the *Engineering Design for Pedestrian Safety at Highway-Rail Grade Crossings*.⁽⁴²⁾ Pedestrian behavior at or adjacent to railroad tracks can be characterized as risky.

Six criteria regarding the pedestrian crossing environment and the desired devices and controls for it, were published by the Transit Cooperative Research Program in Report 69:⁽³¹⁾

- Pedestrian facilities and minimum pedestrian activity present or anticipated
- LRT speed exceeds 35 miles per hour
- Sight distance restricted on approach
- Crossing located in school zone
- High pedestrian activity levels occur
- Pedestrian surges or high pedestrian inattention

Whereas the above criteria were developed for LRT applications, these criteria may be used to evaluate the need for commonly-used pedestrian treatments.

Devices and treatments identified in the *Engineering Design for Pedestrian Safety at Highway-Rail Grade Crossings* include the following:

Passive devices for pedestrian crossings

- Pedestrian swing gates
- Directional surface
- Flange fillers and surfacing
- Dynamic envelope markings
- Z-crossings (zig-zag)
- Channelization
- Oversized ballast
- Bedstead barriers
- Fencing
- Anti-trespass panels

Active devices for pedestrian crossings

- Smart warning systems
- Detectable warning and tactile strips
- Pedestrian gates
- Gate skirts

Pedestrian behavior that violates traffic control at crossings can undermine the effectiveness of treatments at crossings. It has been noted that new treatments installed to mitigate some types of risky pedestrian behavior result in new forms of risky behavior; for example, pedestrians may pull open a swing gate intended for emergency egress and evade a lowered pedestrian gate.

Determining the most applicable type of treatment to use is a site-specific decision based on several criteria, site assessments, and other noteworthy practices.

DIAGNOSTIC STUDY METHOD

Current practice in crossing treatment selection utilizes the diagnostic study method. The approach centers on a field survey procedure using a “Diagnostic Team” composed of experienced individuals knowledgeable in key disciplines including crossing design, safety engineering, rail operations and signaling, and traffic engineering.

This approach is intended to ensure that site-specific features are considered in adapting guidance and standards for treatments to address the issues at a crossing. The diagnostic study method can also provide an interdisciplinary approach which reflects all the technical considerations in selection of a treatment alternative.

As such, the diagnostic study method, supported by additional engineering analyses conducted offsite, provides a structured approach which might satisfy the various requirements for “Engineering Study” as defined in the MUTCD (Part 1A.13). [Refer to Appendix C](#) of this *Handbook* for specific procedures.

ECONOMIC BENEFIT-COST ANALYSIS

An economic analysis may be performed to determine possible alternative improvements that could be made at a highway-rail crossing. The FHWA Highway Safety Benefit Cost Analysis Guide⁽⁴³⁾ and companion Highway Safety Benefit Cost Analysis Tool⁽⁴⁴⁾ and support materials available at the FHWA Highway Safety Improvement Program (HSIP) [website](#) can be used by practitioners to evaluate safety improvement alternatives. Practitioners need to assemble information on the following elements, using the following best available facts and estimates:

- Collision costs
- Service life
- Initial improvement costs
- Maintenance costs
- Salvage value
- Traffic growth rates

Other considerations include the effectiveness of the improvement in reducing collisions and the effects on travel, such as reducing delays.

The selection of collision cost values is of major importance in economic analyses. Considerable care should be used in establishing values for these costs. The following are the two most common sources of collision costs:

- National Safety Council (NSC)
- NHTSA

The NSC costs include wage losses, medical expenses, insurance administrative costs, and property damage. The NHTSA includes the calculable costs associated with each fatality and injury plus the cost to society, such as consumption losses of individuals and society at large caused by losses in production and the inability to produce. Many States have developed their own State-specific values. Whichever is selected, the values should be consistent with those used for other safety improvement programs. An appropriate method of discounting should be used to account for inflation and opportunity cost. The selected discount rate should be informed by current practices and should be documented as part of the analysis.

The service life of an improvement should be equal to the time that the improvement can affect collision rates. Both costs and benefits should be calculated for this time. Hence, the service life is not necessarily the physical life of the improvement. For highway-rail crossings, however, it is a reasonable assumption that the improvement would be equally effective over its entire physical life. Thus, selecting the service life equal to the physical life would be appropriate.

The selected service life can have a profound effect on the economic evaluation of improvement alternatives; therefore, it should be selected using the best available information.

Project costs should include initial capital costs and maintenance costs and should be considered life-cycle costs; in other words, all costs are distributed over the service life of the improvement. The installation cost elements include the following:

- Preliminary engineering
- Labor
- Material
- Lease or rental of equipment
- Miscellaneous costs

The maintenance costs are all costs associated with keeping the system and components in operating condition.

The salvage value may be an issue when a highway is upgraded or relocated, or a railroad line is abandoned. Salvage value is defined as the dollar value of a project at the end of its service life and, therefore, is dependent on the service life of the project. For crossing signal improvement projects, salvage values are generally very small. Due to the characteristics of crossing signals and control equipment as well as the liability concerns that arise from deploying signal equipment that has already been used, it is assumed that there is zero salvage value after 10 years.

RESOURCE ALLOCATION PROCEDURE

In lieu of the economic analysis procedures described above, USDOT has developed a resource allocation procedure for highway-rail crossing improvements. The FRA's User's Guide, *Rail-Highway Crossing Resource Allocation Procedure, Third Edition* (1987), can be accessed here: <https://www.fra.dot.gov/Elib/Document/1537>. This procedure was developed to assist States and railroads in determining the effective allocation of federal funds for crossing traffic control improve

The resource allocation model is designed to provide an initial list of crossing traffic control improvements that would result in the greatest collision reduction benefits based on cost-effectiveness considerations for a given budget. As designed, the results are checked by a diagnostic team in the field and revised as necessary. It should be noted that the procedure considers only traffic control improvement alternatives as described below:

- For passive crossings, single track, two upgrade options exist: flashing-lights or gates
- For passive, multiple-track crossings, the model allows only the gate option to be considered in accordance with the *Federal-Aid Policy Guide*
- For flashing-light crossings, the only improvement option is gates

Other improvement alternatives, such as removal of site obstructions, crossing surface improvements, illumination, and train detection circuitry improvements, are not considered in the resource allocation procedure.

The input data required for the procedure consists of the number of predicted collisions, the safety effectiveness of flashing-lights and automatic gates, improvement costs, and the amount of available funding.

The number of annual predicted collisions can be derived from the USDOT Accident Prediction Model or from any model that yields the number of annual collisions per crossing.

Safety effectiveness studies for the equipment used in the resource allocation procedure have been completed by USDOT, the California Public Utilities Commission, and William J. Hedley. Effectiveness factors are the percent reduction in collisions occurring after the implementation of the improvement.

The model requires data on the costs of the improvement alternatives. Life-cycle costs of the devices should be used, such as both installation and maintenance costs.

Costs used in the resource allocation procedure are usually developed for each of the following three alternatives, as applicable:

- Passive devices to flashing-lights¹
- Passive devices to automatic gates
- Flashing-lights to gates

Caution should be exercised in developing specific costs for a few selected projects while assigning average costs to all other projects. If this is done, decisions regarding the adjusted crossings may be unreasonably biased by the algorithm.

The amount of funds available for implementing crossing signal projects is the fourth input for the resource allocation procedure are at multiple track crossings.

The discussion which follows assumes that a group of crossings, some of which are at single-track sections and others where there are two or more tracks are being evaluated and that some

¹ Practitioners are cautioned to determine whether use of flashing lights without gates is appropriate for such locations; refer to the [Technical Working Group guidance](#) in this section.

crossings are passive whereas others have flashing-lights but no gates. The goal of the analysis is to prioritize crossings for improvement based upon cost-effectiveness, as explained further below.

If, for example, a single-track passive crossing is considered, it could be upgraded with either flashing-lights, with an effectiveness of E_1 , or gates, with an effectiveness of E_2 . The number of predicted collisions at crossing “i” is A_i . Therefore, the reduced accidents per year is $A_i E_1$ for the flashing-light option and $A_i E_2$ for the gate option. The corresponding costs for these two improvements are C_1 and C_2 . The accident reduction/cost ratios for these improvements are $A_i E_1 / C_1$ for flashing-lights and $A_i E_2 / C_2$ for gates. The rate of increase in accident reduction versus costs that results from changing an initial decision to install flashing-lights with a decision to install gates at the crossing is referred to as the incremental accident reduction/cost ratio and is equal to:

$$A_i (E_2 - E_1) / (C_2 - C_1)$$

If, on the other hand, the crossing was a passive crossing in multiple-track territory, then improvements to flashing-lights would not be an option. In this scenario, the upgrade from passive to gates would result in an effectiveness of E_2 , a cost of C_2 , and an accident reduction/cost ratio of $A_i E_2 / C_2$. If this multi-track crossing was originally a flashing-light crossing, the improvement from flashing-lights to gates would be characterized with an effectiveness of E_3 , a cost of C_3 , and an accident reduction/cost ratio of $A_i E_3 / C_3$.

The individual accident reduction/cost ratios associated with these improvements are selected by the algorithm in an efficient manner to produce the maximum accident reduction that can be obtained for a predetermined total cost. This total cost is the sum of an integral number of equipment costs (C_1 , C_2 , and C_3). The total maximum accident reduction is the sum of the individual accident reductions of the form $A_i E_j / C_j$.

The USDOT Rail-Highway Crossing Resource Allocation Procedure, as described in the *Rail-Highway Crossing Resource Allocation Procedure's Guide, Third Edition*, August 1987, DOT/FRA/OS-87/10, uses three “normalizing constants” in the accident prediction formula.⁽⁴⁵⁾ These constants need to be adjusted periodically to keep the procedure matched with the current accident trends, the current number of open public at-grade crossings, and the changes in the warning devices.

For the most recently calculated 2013 normalizing constants, the collision data that was used was for calendar years 2007–2011 (to predict 2012 accidents/incidents). The process of determining the three new normalizing constants for 2013 was performed such that the sum of the 2012 accident prediction values of all open public at-grade crossings in the National Highway Rail Crossing Inventory data that was used was made to equal the sum of the *observed* number of collisions. Note that while mismatched data records between accident/inventory reporting are included, those accidents which occurred prior to the date of a warning device change are excluded, and also excluded are accidents which occurred at closed crossings and nonpublic at-grade crossings as included in the Inventory data used. This process was performed for each of the respective formulae for the three types of warning device categories: passive, flashing-lights, and gates. This process normalizes the calculated predictions for the current trend in collision data for each category and relative to each of the three types of warning device categories (see **Table 8**).

Table 8. Collision Prediction and Resource Allocation Procedure Normalizing Constants

Warning Device Groups	New*	Prior years								
	2013	2010	2007	2005	2003	1998	1992	1990	1988	1986
Passive	0.5086	0.4613	0.6768	0.6407	0.6500	0.7159	0.8239	0.9417	0.8778	0.8644
Flashing-lights	0.3106	0.2918	0.4605	0.5233	0.5001	0.5292	0.6935	0.8345	0.8013	0.8887
Gates	0.4846	0.4614	0.6039	0.6513	0.5725	0.4921	0.6714	0.8901	0.8911	0.8131

Source: Federal Railroad Administration website (<http://safetydata.fra.dot.gov/officeofsafety/default.aspx>).

The most current Normalizing Constants are used in FRA’s [Web Accident Prediction System](#) (WBAPS), on the FRA Safety Data website. Practitioners are encouraged to access this system which can provide the risk reduction factors based upon data in the USDOT grade crossing database.⁽⁴⁶⁾ If the resource allocation procedure is used to identify high-hazard crossings, a field diagnostic team should investigate each selected crossing for accuracy of the input data and reasonableness of the recommended solution. A worksheet for performing this analysis is included in **Figure 61** (or download from this link https://safety.fhwa.dot.gov/hsip/xings/com_roaduser/07010/sec05form3.pdf).

This worksheet also includes a method for manually evaluating or revising the results of the computer model.

This worksheet provides a format and instructions for use in field evaluation of crossing to determine if initial recommendations for warning device installations from the Resource Allocation Procedure should be revised. Steps 1 through 5, described below, should be followed in making the determination. In Steps 1 and 3, the initial information (left column) is obtained from office inventory data prior to the field inspection. In Step 4, the decision criteria values are obtained from the Resource Allocation Model printout.

STEP 1: Validate Data used in Calculating Predicted Accidents:

<u>Crossing Characteristic</u>	<u>Initial Information</u>	<u>Revised Information</u>
Crossing Number		
Location		
Existing Warning Device		
Total Trains per Day		
Annual Average Daily Highway Traffic (e)		
Day thru Trains (d)		
Number of Main Tracks (mt)		
Is Highway Paved? (hp)		
Maximum Timetable Speed, mph (ms)		
Highway Type (ht)		
Number of Highway Lanes (hl)		
Number of Years of Accident History (T)		
Number of Accidents in T Years (N)		
Predicted Accident Rate (A)		

STEP 2: Calculate Revised Accident Prediction from DOT Formula if any Data in Step 1 has been Revised.

Revised Predicted Accidents (A) = _____

STEP 3: Validate Cost and Effectiveness Data for Recommended Warning Device

Assumed Effectiveness of Recommended Warning Device (E) _____ Assumed

Cost of Recommended Warning Device (C)

Recommended Warning Device Installation

STEP 4: Determine if Recommended Warning Device should be Revised if A, E, or C has Changed.

1. Obtain Decision Criteria Values from Resource Allocation Model. Output:

DC₁ = ____ DC₂ = ____ DC₃ = ____ DC₄ = ____

2. Calculate: $R = \frac{\text{Revised A}}{\text{Previous A}} \diamond \frac{\text{Revised B}}{\text{Previous B}} \diamond \frac{\text{Revised C}}{\text{Previous C}}$

3. Compare R with Appropriate Decision Criteria as shown Below:

Existing Passive Crossing (Classes 1, 2, 3, 4) Single Track		Existing Passive Crossing (Classes 1, 2, 3, 4) Multiple Tracks		Existing Flashing Light Crossing (Classes 5, 6, 7)	
Comparison	Decision	Comparison	Decision	Comparison	Decision
DC ₂ < R	Gates	DC ₃ < R	Gates	DC ₄ < R	Gates
DC ₁ < R < DC ₂	Flashing Lights	R < DC ₃	No Installation	R < DC ₄	No Installation
R < DC ₁	No Installation				

4. Revised Recommended Warning Device Installation* _____

STEP 5: Determine other Characteristics that may Influence Warning Device Installation Decisions

Multiple tracks where one train/locomotive may obscure vision of another train?	Either, or any combination of, high vehicular traffic volumes, high numbers of train movements, substantial numbers of school buses or trucks carrying hazardous materials, unusually restricted sight distance or continuing accident occurrences**
Percent trucks	
Passenger train operations over crossing	
High speed trains with limited sight distance**	
Combination of high speeds & moderately high volumes of highway & railroad traffic **	

*The cost and effectiveness values for the revised warning device are assumed to change by an amount proportional to the change in these values for the initial recommended warning device as determined in Step 3.

**Gates with flashing lights are the only recommended warning device per 23CFR 646.214(b)(3)(i).

Source: Railroad-Highway Grade Crossing Handbook, Second Edition. Washington, DC: U.S. Department of Transportation, Federal Highway Administration, 1985.

Figure 61. Resource Allocation Procedure Field Verification

Worksheet Source: Federal Highway Administration website.

FRA GRADEDEC SOFTWARE

The FRA developed the [GradeDec.NET](#) (GradeDec) highway-rail grade crossing investment analysis tool to provide grade crossing investment decision support. The GradeDec provides a full set of standard benefit-cost metrics for a rail corridor, a region, or an individual grade crossing. Model output allows a comparative analysis of grade crossing alternatives designed to mitigate highway-rail grade crossing collision risk and other components of user costs, including highway delay and queuing, air quality, and vehicle operating costs. The online application can be accessed via FRA's website.⁽⁴⁷⁾

The GradeDec is intended to assist State and local transportation planners in identifying the most efficient grade crossing investment strategies. The GradeDec modeling process can encourage public support for grade crossing strategies, including closure and separation, where project success often depends on getting the community involved in the early planning stages. The GradeDec computes model output using a range of values for many of the model inputs. This process allows individual stakeholders to influence how different investment options are weighed and evaluated.

The GradeDec implements the corridor approach to reducing collision risk that was developed as part of the Transportation Equity Act for the 21st Century's Next-Generation High-Speed Rail Program (TEA-21, 1998, PL, 105-178). This approach can be an effective means of reducing the overall capital costs involved in constructing facilities for high-speed passenger rail service (at speeds between 111 and 125 mph), where grade crossing hazards and mitigation measures can be a major cost factor.

The corridor approach can be used to demonstrate that acceptable levels of collision risk have been reached for all rail corridors, train types, and speeds. For example, exceptions to the proposed federal rule mandating whistle-sounding at all highway-rail grade crossings can be made by showing that appropriate safety measures have been taken to mitigate the additional risk otherwise presented by trains not sounding their horns.

The GradeDec uses simulation methods to analyze project risk and generate probability ranges for each model output, including B/C ratios and net present value. The software also analyzes the sensitivity of project risk to GradeDec 2000 model inputs to inform users which factors have the greatest impact on project risk.⁽⁴⁸⁾

MUTCD Interpretations, Experimentation, Changes, and Interim Approvals

As technology and research continue to progress, updates to guidance and standards outlined in this *Handbook*, as well as the MUTCD, may be required. The FHWA periodically updates the MUTCD; however, updates to the document must go through a federal "rulemaking" process which requires posting the document in a Notice of Proposed Action (NPA) and addressing comments received before posting the revised document as a "Final Rule." A number of years may be required to provide a full update to the MUTCD.

The 2009 MUTCD with revisions 1 and 2 is available at https://mutcd.fhwa.dot.gov/pdfs/2009r1r2/pdf_index.htm.

It should be noted that a “hotlinks” PDF version of the MUTCD which contains the most current updates to the MUTCD providing links to official interpretations, corrections to known errors, and other external documents is available at <https://mutcd.fhwa.dot.gov/pdfs/2009r1r2/hotlinksfeatures.htm>.

During the intervening period between MUTCD updates, FHWA may provide “Interpretations” or “Interim Approvals” and practitioners may petition FHWA to conduct “Experimentation” for a new treatment following procedures presented in Section 1A.10 of the MUTCD:

- Interpretations—Practitioners can request FHWA to clarify the intent of MUTCD provisions by formally requesting an official “Interpretation.”
- Interim Approvals—Section 1A.10 of the MUTCD contains a provision authorizing the FHWA to issue Interim Approvals. Such approvals allow the interim use (pending official rulemaking) of a new traffic control device, a revision to the application or manner of use of an existing traffic control device, or a provision not specifically described in the MUTCD. Interim Approvals are considered by the FHWA Office of Transportation Operations based on the results of successful experimentation, studies, or research, and an intention to place the new or revised device into a future rulemaking process for MUTCD revisions.
- Experimentation—Experimentation provides a means for a practitioner to install and evaluate a new device. Although experimentation is a time-consuming process which requires installation of testing and potentially removal of a trial device, it does provide an opportunity to establish new treatments.

Practitioners should be aware of the following:

- Design, application, and placement of traffic control devices other than those adopted in this *Handbook* should be prohibited unless the provisions provided in Section 1A.10 are followed.
- Except as provided in Paragraph 4, of Section 1A.10, requests for any interpretation, permission to experiment, interim approval, or change should be submitted electronically to FHWA, Office of Transportation Operations, MUTCD team, at the following e-mail address: MUTCDofficialrequest@dot.gov.

CHAPTER 4. PROJECT IMPLEMENTATION

Chapter 4 discusses a high-level approach to project implementation, including how projects are programmed, potential funding sources at different levels of government, and agreements that should be considered. This chapter also discusses the design and construction of the programmed improvements, as well as traffic control measures that should be considered during construction phases.

PROGRAM DEVELOPMENT

Program development is one of the final steps in the overall process. It is the selection of the specific improvement projects (including the type of improvement to be made along with the estimated cost of such improvement) to be included in a highway-railroad crossing improvement program. This selection process is data-driven for efficiency and effectiveness. These projects are then moved forward into implementation.

A program should use an established method, consider all locations, and prioritize projects based on risk and other objective criteria. It is important for an agency to document the project selection process and method. The prioritization of a crossing for improvement can be done individually, or a corridor approach can be used. The corridor approach evaluates many crossings along a railroad line. Utilizing this method, the potential for improving the efficiency of railroad and highway operations may be considered.

The total program should include more projects than can reasonably be funded. This is to ensure that substitutions can be made in the priority list following field evaluation of the crossings by the Diagnostic Team or if other unforeseen issues arise that delay a project, another project can be advanced.

To aid in the programming of projects, a resource allocation model (as discussed in Chapter 3) has been developed to assist in making allocation decisions. The methodology, using a highway-railroad crossing crash or incident prediction formula, traffic control device system effectiveness, and cost parameters, provides a funding priority ranking of projects. On the State and local levels, it can be used to prioritize crossing projects and options through a data-driven process.

It should be emphasized that, in the use of ranking procedures (for example, hazard indices or resource allocation), the quantitative ranking does not dictate the final decision. These tools should be considered only as an aid to State and local officials and railroad management for making decisions. Local conditions and the judgment of State and local officials should also play a role in this evaluation process.

Note: This document summarizes current practices but does not set standards; practitioners are advised to check current local standards and requirements (refer to Disclaimer and Quality Assurance Statement). Users of the data provided within this document should anticipate possible variations from current information within the FRA databases, which are updated monthly.

FUNDING

Sources of funds for highway-rail grade crossing improvements include federal, State, and local government agencies, and the railroad industry to a lesser extent. Additional information regarding funding sources and their history and legacies can be found in Appendix A, Section 2.

Federal Sources

Federal program sources of funding have grown and adapted over the years. This section will briefly discuss some of the more impactful funding sources that have been available in recent years and their importance. It is important to note that most federal-aid funding programs are State administered.

Highway Safety Improvement Program

The Highway Safety Improvement Program (HSIP) is a core federal-aid Highway program with the purpose to achieve a significant reduction in traffic fatalities and serious injuries on all public roads, including non-State-owned roads and roads on tribal land. The HSIP requires a data-driven, strategic approach to improving highway safety on all public roads with a focus on performance.⁽⁴⁹⁾ The HSIP is legislated under Section 148 of Title 23, United States Code (23 U.S.C. 148) and regulated under Part 924 of Title 23, Code of Federal Regulations (23 CFR 924). The HSIP consists of three main components, the Strategic Highway Safety Plan (SHSP), State HSIP or program of Highway Safety Improvement Projects and the Railway-Highway Crossing Program (RHCP). The RHCP is legislated under Section 130 of Title of the United States Code (23 U.S.C. 130), with funding allocated to States as a set-aside of the HSIP.

Section 130

The RHCP provides funds for the elimination of hazards at railway-highway crossings. Program requirements and eligibility information can be found on the FHWA Office of Safety website at <https://safety.fhwa.dot.gov/hsip/xings/>. The Section 130 Program has been correlated with a significant decrease in fatalities at railway-highway grade crossings. Since RHCP's establishment in 1987 through 2017, for which most recent data is available, fatalities at these crossings have decreased by approximately 56 percent according to FRA data.⁽⁵⁰⁾ The overall reduction in fatalities comes despite an increase in the vehicle miles traveled on roadways and an increase in the passenger and freight traffic on the railways.

The 2015 Fixing America's Surface Transportation Act (FAST Act, PL 114-94) continues the annual set-aside for railway-highway crossing improvements under 23 U.S.C. 130(e).⁽⁵¹⁾ The funds are set-aside from a State's Highway Safety Improvement Program (HSIP) apportionment by a legislative formula and allocated to States, who administer the Federal-aid Highway Program with federal oversight. The FAST Act increased the set-aside amount for each fiscal year as shown. In addition, the Consolidated Appropriations Act of 2016 (Public Law 114-113) provided a one-time increase for fiscal year 2016.

- FY 2016: \$350 million
- FY 2017: \$230 million
- FY 2018: \$235 million
- FY 2019: \$240 million
- FY 2020: \$245 million

Other federal-aid highway funds may be used for improvements at crossings, depending upon the specific program eligibility guidelines. For example, HSIP funds other than Section 130 funds may be eligible for rail crossing safety improvements if a State has determined a need through its data-driven SHSP. Surface Transportation Block Grant Program funds may be another federal-aid highway funding source. See Appendix A for more information on federal-aid crossings improvement programs.

Consolidated Rail Infrastructure and Safety Improvements Program (CRISI)

The FRA periodically provides grant funding for rail improvements which may be used to pay for crossing elimination and improvements. This program provides a comprehensive solution to leverage private, State and local investments to support safety enhancements and general improvements to infrastructure for both intercity passenger and freight railroads. Congress authorized this grant program for the Secretary to invest in a wide range of projects within the United States to improve railroad safety, efficiency, and reliability; mitigate congestion at both intercity passenger and freight rail chokepoints; enhance multi-modal connections; and lead to new or substantially improved Intercity Passenger Rail Transportation corridors. Additionally, the program includes rail safety projects, such as grade crossing enhancements, and rail line relocations and improvements. Applicable work also includes the following: rail regional and corridor planning, environmental analyses and research, workforce development, and training.

In 2018, the FRA issued a Notice of Funding Opportunity for the CRISI Program that includes more than \$318 million in grant funding authorized under the FAST Act. The CRISI grant program directs at least 25 percent of available funds towards rural communities to safely connect and upgrade rural America's rail infrastructure.

In addition, selection preference is given to projects with a 50 percent non-federal funding match from any combination of private, State, or local funds. The USDOT will consider how well the project aligns with key objectives including supporting economic vitality; leveraging federal funding; preparing for life-cycle costs; using innovative approaches to improve safety and expedite project delivery; and holding grant recipients accountable for achieving specific, measurable outcomes.

Additional requirements that may pertain to the use of federal-aid funds are as follows:

- Federal funds are not eligible for costs incurred solely for the benefit of the railroad.
- At grade separations, federal funds are eligible to participate in costs to provide space for more tracks than are in place when the railroad establishes to the satisfaction of the State highway agency and FHWA that it has a definite demand and plans for the installation of the additional tracks within a reasonable time.
- Railroad share in the cost of certain crossing improvement projects is specified in 23 CFR 646.210.⁽⁵²⁾ Exceptions include the following:
 - State laws that require railroads to share in the cost of work for the elimination of hazards at highway-rail crossings shall not apply on federal-aid projects.

- Projects for crossing improvements are deemed to be of no ascertainable net benefit to the railroads and there shall be no required railroad share of the costs.
- Projects for the reconstruction of existing grade separations are deemed to generally be of no ascertainable net benefit to the railroad and there should be no required railroad share of the costs, unless the railroad has a specific contractual obligation with the State or its political subdivision to share the costs.
- As per 23 CFR 646.212(a)(3), the federal share of the cost of a grade separation should be based on the cost to provide horizontal and/or vertical clearances used by the railroad in its normal practice, subject to limitations as shown in the appendix or as required by a State regulatory agency.⁽⁵³⁾
- The railroad share of federal-aid projects that eliminate an existing crossing at which active control devices are in place or ordered to be installed by a State regulatory agency is to be 5 percent. These costs are to include costs for preliminary engineering, ROW, and construction as specified below and in 23 CFR 646.210:
 - Where a crossing is eliminated by grade separation, the structure and approaches required to transition to a theoretical highway profile that would have been constructed if there were no railroad present, for the number of lanes on the existing highway and in accordance with the current design standards of the State highway agency.
 - Where another facility, such as a highway or waterway, requiring a bridge structure is located within the limits of a grade-separation project, the estimated cost of a theoretical structure and approaches as described in 23 CFR 646.210 (c)(1) to eliminate the highway-rail crossing without considering the presence of the waterway or other highway.
 - Where a crossing is eliminated by railroad or highway relocation, the actual cost of the relocation project, the estimated cost of the relocation project, or the estimated cost for a structure and approaches as described in § 646.210 (c)(1) whichever is less.
 - Railroads may voluntarily contribute a greater share of project costs. Also, other parties may voluntarily assume the railroad's share.

Additional information can be found at the following websites:

- <https://www.fhwa.dot.gov/federalaid/projects.cfm>
- <https://www.fhwa.dot.gov/fastact/factsheets/railwayhwycrossingsfst.cfm>
- <https://www.fhwa.dot.gov/policy/olsp/fundingfederalaid/>

State Funding

Section 130 RHCP funds are allocated by legislative formula to States who administer the Federal-aid Highway Program under federal oversight. Historically, States also have participated in funding highway-rail crossing improvement projects through fuel taxes and other sources. Additionally, States sometimes finance entire crossing projects, particularly if the crossing is on a State highway, or a State may set aside a designated amount of State funds for specific work as a sub-program such as crossing surface improvements.

In general, for crossings on the State highway system, States provide for the maintenance of the highway approach and for traffic control devices not located on the railroad ROW. Typically, these include advance warning signs and pavement markings.

Local Agency Funding

Cities and counties can establish highway-rail crossing improvement programs in their local agencies. These types of programs can provide funding for partial reimbursement of railroad maintenance costs at crossings, or can meet the matching requirements of State and federal programs. Local agencies are often sources of funding for low-cost improvements such as removing vegetation and providing illumination. In addition, local agencies are responsible for maintaining the roadway approaches and the traffic control devices off the railroad ROW on highways under their maintenance jurisdiction.

Railroad Funding

Railroads often volunteer to participate if they receive some benefit from the project. For example, if a project includes the closure of one or more crossings, the railroad may benefit from reduced maintenance costs. Railroads also may assist in low-cost improvements such as changes in railroad operations, track improvements, ROW clearance, and others.

AGREEMENTS

A highway-rail crossing project involves a minimum of two parties: the State and the railroad. If the crossing is not on the State highway system, an agreement with the county or municipality having maintenance and enforcement jurisdiction over the road will usually be required. The agreement between the State agency and the railroad should establish the project location, scope of work, standards to be applied, basis of payment, and billing procedures. The agreement between the State and the local jurisdiction should do the following:

- Provide the authority for the State and the railroad to work and control traffic on the local facility
- Provide the amount and basis of payment for any local share
- Establish the maintenance responsibility for the improvement
- Provide for the passage of a law or ordinance so that any traffic control devices being installed at the crossing can be implemented and enforced

Current practice is to define project responsibilities of the highway authority and the railroad in construction and maintenance (C&M) agreements developed prior to initiation of final design and construction of improvements. The C&M agreements can include provisions regarding right of entry and railroad flagging.

The FHWA provides a variety of resources and tools that encompass strategies to help railroads and DOT's mitigate the responsibilities between the two agencies. The publication *Strategies for Improving the Project Agreement Process Between Highway Agencies and Railroads* is comprised of model documents that can be used as a resource for both agencies to help expedite negotiations.⁽⁵⁴⁾

DESIGN AND CONSTRUCTION

The design of highway-rail crossing improvement projects is usually completed by the State or engineering consultant selected by the State (per FHWA federal-aid requirements for consultant selection) where federal and State funds are to be used or by the local roadway authority or its engineering consultant when local funds are to be used.

The railroad signal department usually prepares the design for the active traffic control system, including the train detection circuits. In addition, the railroad signal department usually prepares a detailed cost estimate of the work.

Adequate provision for needed easements, rights of way, temporary crossings for construction purposes, or other property interests should be included in the project design and covered in the agreement.

TRAFFIC CONTROL DURING CONSTRUCTION

Traffic control for highway-rail crossing construction is very similar to traffic control for highway construction. The major difference is that the work area is in joint-use ROW, and the possibility of conflict exists between rail and highway traffic as well as in construction operations. Construction areas can present unexpected or unusual situations to the motorist as far as traffic operations are concerned. Because of this, special care should be taken in applying traffic control techniques in these areas.

Temporary Traffic Control (TTC), as found in Part 6 of the MUTCD, discusses the importance of each mode of transportation and road user in relation to highway construction, utility work, maintenance operations, and the management of traffic incidents. Additional information regarding the requirement for a Traffic Management Plan for significant projects and TTC for non-significant projects can be found in Subpart J and K of the Work Zone Management Program's *Work Zone Safety and Mobility Rule (Subpart J)* and the *Temporary Traffic Control Devices Rule (Subpart K)* (website: <https://ops.fhwa.dot.gov/wz/resources/policy.htm>).

Traffic safety in construction zones should be an integral and high-priority element of every project, from planning through design and construction. The TTC planning is important to provide continuity for the movements of all modes and highway-users during periods when the normal function of the roadway is suspended. Providing for the safe and effective movement of highway-users as they travel through or around a TTC zone, while also focusing on the safety of workers and first responders, is a key function of TTC. The basic safety principles governing the design of crossings should also govern the design of construction and maintenance sites. The goal should be to route traffic through such areas with geometries and traffic control devices comparable, as possible, to those for normal crossing situations.

A traffic control plan in detail appropriate to the complexity of the work project should be prepared and understood by all responsible parties before the site is occupied. If traffic flow will be impacted or the roadway will be closed, advance notification to the public should be provided to the public through news releases, social media, and other means as needed. Information on the length and times of closure or impact as well as established detour information should also be provided.

When planning construction or maintenance work at highway-rail crossings, proper coordination with the railroad is essential. The safety of road users, highway and railroad work crews, and train crews can best be provided through the development of a work plan to meet the needs of rail and highway traffic.

Traffic Control Zones

When traffic is affected by construction, maintenance, utility, or similar operations, traffic control is needed to safely guide and protect road users and workers in a traffic control zone. The traffic control zone is the distance between the first advance warning sign and the point beyond the work area where traffic is no longer affected. Temporary traffic control should be developed and/or reviewed by the road authority, not the railroad.

Traffic Control Devices

Signs. Regulatory and warning signs are used in construction work areas. Regulatory signs impose legal restrictions and may not be used without permission from the authority having jurisdiction over the highway. Warning signs are used to give notice of conditions that are potentially hazardous to traffic.

Delineators. Delineators are reflective units with a minimum dimension of approximately 3 inches. Delineators should not be used alone as channelizing devices in work zones but may be used to supplement these channelizing devices in outlining the correct vehicle path. They are not to be used as a warning device. To be effective, several delineators need to be seen at the same time. The color of the delineator should be the same as the pavement marking that it supplements.

Pavement markings. Pavement markings, in conjunction with delineators, outline the vehicular path and, thus, guide the motorist through the construction area. Pavement markings include longitudinal markings such as center lines, edge lines and lane lines, as well as word, symbol and arrow markings.

Channelizing devices. Channelizing devices consist of cones, tubular markers, vertical panels, drums, barricades, and barriers (refer to MUTCD Figure 6F-7). These types of devices are used to maintain traffic through work zones.

Lighting devices. Three types of warning lights may be used in construction areas. Flashing-lights are appropriate for use on a channelizing device to warn of an isolated hazard at night or call attention to warning signs at night. High-intensity lights are appropriate to use on advance warning lights during day and night. Steady-burn lights are appropriate for use on a series of channelizing devices or on barriers that either form the taper to close a lane or shoulder, or keep a section of lane or shoulder closed, and are also appropriate on the channelizing devices alongside the work area at night.

Flagging. Flagging of the highway should be used only when required to control traffic or when all other methods of traffic control are inadequate to warn and direct drivers. The procedures for flagging traffic are contained in MUTCD Chapter 6E. It should be noted that construction activity within the railroad right-of-way will require railroad flagging. The industry standard

is that the operating railroad will provide flaggers with the appropriate safety certifications. Availability of railroad flaggers is limited and construction activities need to be carefully coordinated with the railroad which controls the scheduling of qualified flaggers.

Typical Applications

Practitioners should refer to Part 6 of the MUTCD for various “Typical Applications” of temporary traffic control, some of which could be used where a construction detour near a crossing is required. Two examples showing applications of traffic control devices in crossing work zones are shown in **Figure 62** and **Figure 63** for work in the vicinity of a crossing and where there is work on a side road with a crossing, respectively. The dimensions shown in these figures may be adjusted to fit field conditions in accordance with the guidelines presented in MUTCD and the *Traffic Control Devices Handbook*. When numerical distances are shown for sign spacing, the distances are intended for rural areas and urban areas with a posted speed limit of 45 mph or more. For urban areas with a posted speed of 45 mph or less, the sign spacing should be in conformance with **Table 9**.

Table 9. Recommended Advance Warning Sign Minimum Spacing

Road Type	Distance Between Signs ^b		
	A	B	C
Urban (low speed) ^a	100 feet	100 feet	100 feet
Urban (high speed) ^a	350 feet	350 feet	350 feet
Rural	500 feet	500 feet	500 feet
Expressway/Freeway	1,000 feet	1,500 feet	2,640 feet

^a Speed category to be determined by the highway agency.

^b The column headings A, B, and C are the dimensions shown in Figures 6H-1 through 6H-46 (MUTCD). The A dimension is the distance from the transition or point of restriction to the first sign. The B dimension is the distance between the first and second signs. The C dimension is the distance between the second and third signs. (The “first sign” is the sign in a three-sign series that is closest to the TTC zone. The “third sign” is the sign that is furthest upstream from the TTC zone.)

Source: Manual on Uniform Traffic Control Devices, 2009 Edition, Washington, DC, FHWA, 2009.

Signs with specific distances shown should not be used if the actual distance varies significantly from that shown. The word message “Ahead” should be used in urban areas and in other areas where a specific distance is not applicable. Standard crossing pavement markings are not shown in the figures for clarity but should be utilized where appropriate. All applicable requirements for traffic control in work areas set forth in MUTCD should apply to construction and maintenance of crossings. Additional traffic control devices other than those shown in the figures should be provided when highway and traffic conditions warrant. These devices should conform to the requirements of MUTCD. All traffic control devices that are not applicable at any specific time should be covered, removed, or turned to not be visible to the motorist.

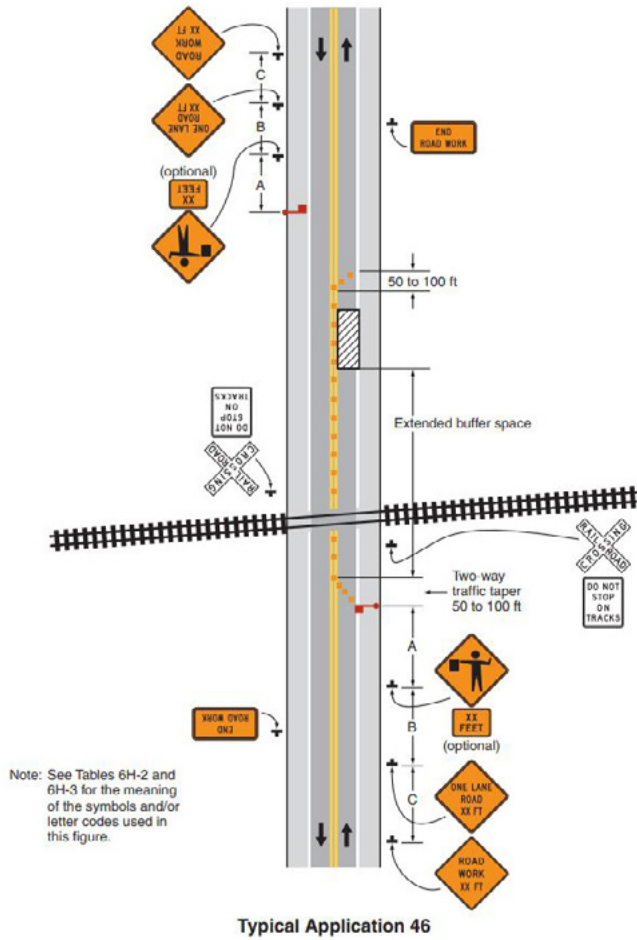

Figure 62. Work in the Vicinity of a Crossing (TA-46)

Source: *Manual on Uniform Traffic Control Devices, 2009 Edition, Washington, DC, FHWA, 2009.*

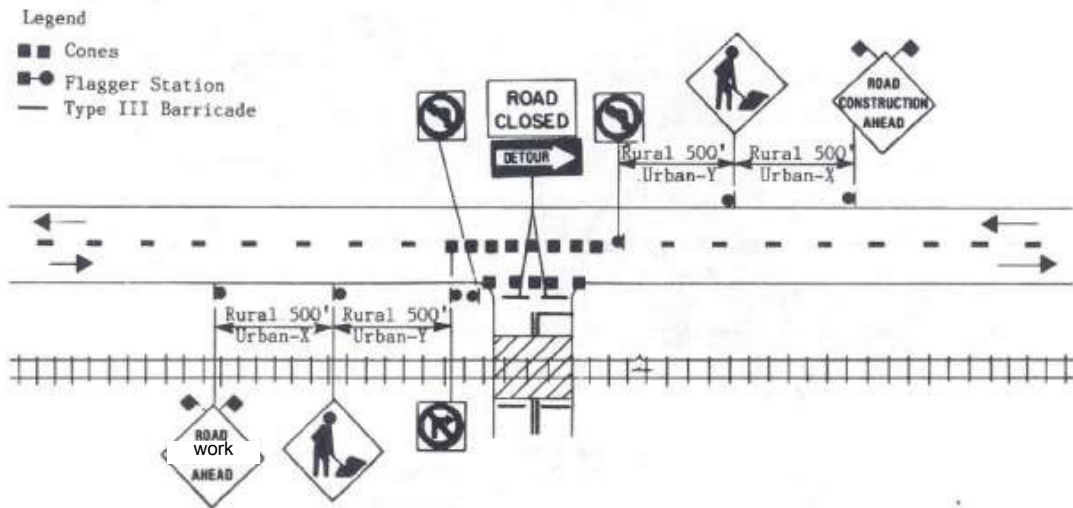

Figure 63. Crossing Work Activities, Closure of Side Road Crossing

Source: *Railroad Highway Grade Crossing Handbook, Revised Second Edition.*

CHAPTER 5. MAINTENANCE, MANAGEMENT, AND OPERATIONS

RESPONSIBILITIES

The highway-rail crossing is unique as compared to other highway features in that railroads install, operate, and maintain the traffic control devices located at the crossing. Even though much of the cost of designing and constructing crossings, including traffic control devices, is assumed by the public, current procedures place maintenance responsibilities for devices located in the railroad ROW with the railroad. The railroad may be responsible for crossing surface maintenance within the rail and for several feet outside of the rail proper, depending upon State law. The public agency having jurisdiction usually terminates its responsibility for the roadway at the crossing surface.

Traffic control devices on the approach, in most instances, are the responsibility of the public agency. Maintenance-sharing with highway or other local authorities is typically included in C&M agreements developed prior to initiation of final design and construction of improvements. It should be noted that the railroad that usually installs and maintains the active warning system within the railroad right-of-way may require local jurisdictions to assume the added maintenance cost for treatments installed to obtain a Quiet Zone.

The highway agency is usually responsible for traffic control devices that are outside of the railroad ROW. The highway authority is also usually responsible for all types of advance warning signs.

TRAFFIC CONTROL DEVICES

Traffic control devices on approaches to highway-rail crossings require regular inspection and maintenance. Pavement markings, if present, may need to be replaced to maintain adequate retroreflectivity and legibility of word and symbol markings. Signs on the approaches will gradually lose their retroreflectivity and should be inspected as outlined in MUTCD Section 2A.08.

Lighting and active devices should be observed on a regular basis and re-lamped as necessary. Road crews should be on alert for missing or damaged devices. Road crews should also observe the approach roadway to confirm that vegetation does not obscure the traffic control devices from approaching drivers and should trim or cut trees or brush as necessary.

Higher-quality materials, such as improved sign sheeting and preformed tape, thermoplastic, or other durable pavement marking materials, can offer dual benefits by increasing the effectiveness of the devices while reducing the required number of maintenance cycles.

Note: This document summarizes current practices but does not set standards; practitioners are advised to check current local standards and requirements (refer to Disclaimer and Quality Assurance Statement). Users of the data provided within this document should anticipate possible variations from current information within this document should anticipate possible variations from current information within the FRA databases, which are updated monthly.

INTERCONNECTED SYSTEMS

Interconnected traffic signals and AAWS signs should be jointly inspected on a regular basis by State and railroad signal personnel. County or municipal representatives need to be included in this inspection if they share the responsibility for operation or maintenance of the device. Operation of the preempt should be checked any time a railroad or roadway signal maintainer visits the crossing or the highway intersection. Installation of recording devices which monitor train detection and operation of the relays associated with operation of the railroad warning devices should be provided in accordance with current FRA policies. The highway agency and the local law enforcement agency should have a railroad company's telephone number available 24 hours per day to report railroad signal damage or malfunctions.

Relevant Federal requirements include the following regulations, safety advisories, and technical bulletins:

- 49 CFR 234.261—Requires that a railroad test each highway traffic control signal pre-emption interconnection for which it has maintenance responsibility at least once each month.
- FRA Technical Bulletin S-12-01—“Guidance Regarding the Appropriate Process for the Inspection of Highway-Rail Grade Crossing Warning System Pre-Emption Interconnections with Highway Traffic Signals”: This technical bulletin recommends that the inspector conduct the following: review circuit plans which should show the interconnection and designed pre-emption time; request maximum right-of-way transfer time (RTT), minimum track clearance green (TCG) interval, and “worst-case” traffic control signal condition from the highway authority, and test pre-emption function by observing a train movement and implementation of the pre-emption function.⁽⁵⁵⁾
- FRA Safety Advisory 2010-02—“Signal Recording Devices for Highway-Rail Grade Crossing Active Warning Systems that are Interconnected with Highway Traffic Signal Systems”⁽⁵⁶⁾: This safety advisory recommends that States, local highway authorities, and railroads install, maintain, and upgrade railroad and highway traffic signal recording devices at crossings. This safety advisory also recommends that States, local highway authorities, and railroads conduct comprehensive periodic joint inspections of highway traffic signal pre-emption interconnections and use information obtained from any railroad and highway traffic signal recording devices during those inspections to determine whether further investigation of any recorded operational anomalies may be warranted. Additional information on recording devices can be found in an Informational Report published by USDOT/FHWA.⁽⁵⁷⁾

ROADSIDE CLEAR ZONE

As defined by the AASHTO *Roadside Design Guide*⁽²³⁾, the roadside clear zone is the total roadside border area, starting at the edge of the traveled way, available for safe use by errant vehicles. This area may consist of a shoulder, a recoverable slope, a non-recoverable slope, and/or a clear run-out area. This area allows a driver to stop safely or regain control of a vehicle that has left the roadway.

The AASHTO *Roadside Design Guide* recommends a clear zone width of 30 to 32 feet for flat, level terrain adjacent to a straight section of a 60-mph highway with an average daily traffic of

6000 vehicles. For steeper slopes, AASHTO recommends a 36 to 44 foot zone. For horizontal curves, AASHTO indicates the clear zone can be increased by up to 50 percent from these figures.

The roadside clear zone serves the dual purpose of increasing the visibility of the crossing and traffic control devices as well as providing a safe recovery area for an errant motorist. The clear zone should be kept free of brush; trees that are more than 4 inches in diameter or that may obscure traffic control devices; and rocks, eroded areas, standing water, or other defects that may entrap an errant vehicle or lead to deterioration of the roadway or track structure.

The maintenance of the sight triangle, beyond highway and railroad ROW, presents a unique problem. Except for portions on the railroad ROW, this often involves private property. The removal of trees, brush, crops, buildings, signs, storage facilities, and other obstructions to the driver's view requires the landowner's permission to access to the property to remove the obstruction.

ROADSIDE APPROACHES

In addition to typical roadway maintenance, the following are a few special considerations maintenance forces need to keep in mind on roadway approaches to a crossing:

- Roadway maintenance equipment can damage crossing surfaces or the adjacent track. Repairs adjacent to the crossing should be done with care.
- Maintenance personnel should be aware of potential train movements and should be alert for trains. Highway authorities should coordinate with the railroad before conducting roadway maintenance in the vicinity of a crossing, and most railroads require use of a flagman if maintenance activities are conducted within 8 feet of the near rail.
- Drainage from the crossing or track structure should not be blocked when maintaining pipes and ditches.
- Snow removal and ice control should be done with care. Snow should not be plowed such that longitudinal piles extend across the tracks. Snowplows can damage crossing surfaces. Chemicals can corrode track and fittings and can short-out track circuits. Snow and slush should not be pushed or carried onto the crossing.
- Where possible, resurfacing operations should be coordinated with the railroad. Resurfacing lifts should be feathered near the crossing so as not to leave the crossing surface in a hole or dip. Drainage should be checked to assure that the additional roadway height has not directed water onto the crossing surface. All necessary steps should be taken to prevent interference between resurfacing equipment and personnel and trains.

ROUTINE MAINTENANCE

Highway maintenance personnel should be aware of the design, operational, safety, and maintenance issues surrounding highway rail crossings and railroad track structure. In particular, activities which could affect the vertical profile and the interface between the rail right-of-way and the approach roadway should be coordinated with the railroad, and railroads should also coordinate maintenance activities that affect vertical profile with the adjacent highway authority. Pavement markings and signs should be kept up to date and worn, damaged, or missing signs

should be replaced. The railroad stop line should be maintained the proper distance from active warning devices and the placement of advance warning signs should be consistent with advance pavement markings. The roadway maintenance supervisor should pay attention to the crossings under his or her jurisdiction and coordinate with the railroad, as necessary, to resolve any problems. If maintenance is being done under a regular program, coordination with affected railroad(s) can address these issues at all relevant crossings. The maintenance supervisor should also contact the crossing program administrator, as necessary, should any needed improvements be identified. Railroad road masters, track supervisors, signal inspectors, and signal maintainers also have a critical role in maintaining features of a highway-rail crossing.

BLOCKED CROSSINGS

A crossing can become blocked when a train is required to stop for a signal or during switching operations. Even if the crossing is not physically occupied by a train, if a train is standing on the track circuits used to activate the crossing warning system, the flashing-light signals and crossing gates may activate and indicate to road users that a train is approaching the grade crossing.

Appendix C to the FHWA/FRA *Noteworthy Practices Guide*⁽⁵⁸⁾ notes the following consequences of blocked crossings:

- Excessive Roadway Delays
- Increased Emergency Response Time
- Truck Traffic Detours onto Local Streets
- Pedestrians Cutting Through or Under Trains

The FRA regulations do not specifically address the length of time a train may block a grade crossing. However, FRA regulations do address standing (idling) trains that unnecessarily activate grade crossing warning devices such as flashing lights and gate arms.⁽⁵⁹⁾ FRA regulations specifically prohibit standing trains, locomotives, or other rail equipment from interfering with the normal functioning of crossing warning devices without first taking measures to provide for the safety of highway traffic.

Responsibility for grade crossings varies among the States. For some, it is divided between several public agencies and the railroad. In other States, jurisdiction is assigned to regulatory agencies such as public utility commissions, public service commissions, or State corporation commissions. Still other States split the authority among State, county, and city governmental agencies that have jurisdiction and responsibility for their respective highway systems.⁽¹¹⁾ Where there is a conflict between the State law and federal rail safety requirements, the courts have found the State law to be superseded by federal requirements.

Solutions to Blocked Crossings

Appendix C to the *Noteworthy Practices Guide* addresses potential remedies and encourages States to address these issues in their respective State Action Plans.^a Improved communication between the railroad, the local community, and local emergency services personnel is encouraged.

Potential operational changes that a railroad might make include the following:

- Hold a train outside the congested area until it can move through the grade crossing without stopping
- Improve management of rail yard traffic to accommodate train movements more efficiently
- Trains awaiting a crew change should be located in an area that allows minimal frequency of blocked crossings
- Break a long train by de-coupling two rail cars to allow the resumption of highway traffic when it is anticipated that a grade crossing will be blocked for an extended period

Potential mitigation strategies for chronic grade crossing blockages include the following:

- Use private and/or public investments to:
 - Add tracks, lengthen sidings, or make other rail infrastructure improvements
 - Create grade separations where the highway is located above or below the tracks
 - Close and consolidate grade crossings to mitigate congestion and improve traffic flow
 - Relocate a rail line to a completely new right-of-way
- Provide advance warning of blocked grade crossings to motorists and emergency responders and recommend possible alternate routes via Intelligent Transportation Systems
- Improve communication between, and provide training for, railroads, local communities, State agencies, and emergency responders
- Encourage local governments to formally consider the potential for new residential or commercial development to generate more highway traffic and how such developments may impact grade crossing use, safety and emergency response

^a The Railroad Safety Improvement Act (RSIA) of 2008 required the ten states with the highest number of grade crossing collisions during 2006, 2007 and 2008 to develop action plans identifying specific solutions for improving safety at crossings.

DOT CROSSING INVENTORY

The FRA is the custodian for the U.S. DOT National Highway-Rail Crossing Inventory (“Crossing Inventory”), which is a national database of highway-rail and pathway crossings. Regulations governing railroad reporting to the Crossing Inventory were published by FRA in 2015. See Appendix C, Section 1 for further details.

The Guide for Preparing U.S. DOT Crossing Inventory Forms (“Inventory Guide”) provides instructions for how to fill out the Crossing Inventory form to submit crossing data to the Crossing Inventory. The Inventory Guide can be found at: <https://safetydata.fra.dot.gov/OfficeofSafety/Documents/Crossing%20Inventory%20Guide%20Final.pdf>.

CHAPTER 6. SPECIAL TOPICS

Several issues are important to highway-rail crossing safety and operations that either were not specifically covered in previous chapters or warrant special consideration. These include the following:

- Private Crossings
- Short-line Railroads
- LRT and Busways
- High-Speed Rail
- Trucks and Buses
- Bicycles and Motorcycles
- Intelligent Transportation Systems
- Quiet Zones

PRIVATE CROSSINGS

Private highway-rail crossings are generally located on roadways not open to use by the public. Usually, an agreement between the land owner and the railroad governs the use of the private crossing. Typical types of private crossings are as follows:

- Farm crossings that provide access between tracts of land lying on both sides of the railroad
- Industrial plant crossings that provide access between plant facilities on both sides of the railroad
- Residential access crossings over which the occupants and their invitees reach private residences from another road, frequently a public road paralleling and adjacent to the railroad ROW
- Utility access crossings over which a utility company or public authority reach electric, sewer, water, flood control, or other facilities from another road
- Temporary crossings established for the duration of a private construction project or other seasonal activity
- In some instances, changes in land use may result in a need for the private crossing to become a public crossing. If the public uses a crossing, appropriate traffic control devices should be installed for warning and guidance. Usually the conversion of a private crossing will be governed by a construction and maintenance agreement with the public road authority and the railroad. Some State laws may have minimum traffic control device requirements that apply to

Note: This document summarizes current practices but does not set standards; practitioners are advised to check current local standards and requirements (refer to Disclaimer and Quality Assurance Statement). Users of the data provided within this document should anticipate possible variations from current information within this document should anticipate possible variations from current information within the FRA databases, which are updated monthly.

the conversion of a private crossing to a public crossing. However, State and federal funds are generally not available for use at private crossings.

As with public crossings, the first option to be considered for improving private crossings is closure. Adjacent public crossings should be evaluated to determine if they can be used instead of the private crossing. Every effort to close the crossing should be made.

Some private crossings have sufficient train and roadway traffic volume to necessitate active traffic control devices. Considerations for the installation of these devices are the same as for public crossings. Federal funds and, often, State funds cannot be used for the installation of traffic control devices at private crossings. The railroad and the landowner usually come to an agreement regarding the financing of the devices.

SHORT LINE RAILROADS

There are numerous short line railroads, and the number is growing due to federal deregulation. Short line railroads are typically Class III railroads, as defined by the STB. Class III railroads include all switching and terminal companies and all line-haul railroads that have annual operating revenues of less than \$35,809,698 million (as of 2017).⁽⁶⁰⁾ Many of these short line railroads provide switching and terminal services for the larger Class I and II railroad companies. Many short line railroads are members of the American Short Line and Regional Railroad Association (ASLRRA). The ASLRRA provides liaison with governmental agencies, serves as a source for information and assistance, and provides other benefits to short-line railroads.

Ownership of these smaller rail lines varies from State or local governments, port authorities, other short lines, private entrepreneurs, and shipper groups. Many new owners of short lines are keenly aware of the costs of line acquisition, track and rolling stock rehabilitation, and other operational expenditures. However, new operators may be unaware of the substantial expenditures needed for rebuilding crossing surfaces, renewing older traffic control systems, and maintaining them.

Costs associated with crossings may constitute a considerable portion of the limited annual maintenance-of-way budgets of short-line railroads. An abandoned plant, when acquired by the new owner, may not be in good condition. The track condition may be adequate, requiring little annual expense in comparison to other plant needs. Therefore, as annual track maintenance costs are reduced, crossing expenditures may constitute as much as 50 percent of the annual maintenance-of-way budget over a period of years. This depends on factors such as the location of the line in relation to population centers and the volume of heavy truck traffic.

On short-line railroads, there is often a lack of specialized personnel in-house for handling crossing responsibilities, such as the continuing maintenance of highly complex electronic grade crossing warning systems.

Although rail traffic on smaller lines tends to be sparse, as well as slow, grade crossing safety on smaller lines is no less important than those on larger railroads. National statistics indicate that the vast majority of crossing collisions occur at relatively low train speeds.

Adequate planning is essential to ensure the proper formation of new short line railroads and to improve their survival as a necessary part of the U.S. transportation system. State agencies can assist by informing short line railroads of the requirements for improving crossings on their system and direct them to other appropriate sources of information. State agencies should ensure that the short line railroads operating in their State are included in the lines of communication regarding crossings. Short line railroads also should be encouraged to participate in other crossing safety programs, such as Operation Lifesaver.

LIGHT RAIL AND BUSWAYS

Where LRT and Busways are separated from highway facilities, their design and operations can be very similar. These parallels can be seen in the configuration, signage, and policy guidance recommended for each type. It is important to note where an FTA-regulated rail service operates in a “shared corridor” with conventional rail, FRA regulations apply at crossings. The National Transit Database (NTD) is a valuable resource of data regarding operation and safety data for transit operations. The following section highlights some important considerations for both LRT and busway crossings.

Table 10 presents typical issues and possible solutions at LRT crossings through which Light Rail Vehicles (LRVs) operate. These issues are separated into five categories: system design, system operations, traffic signal placement and operations, automatic gate placement, and pedestrian control.

Table 10. Possible Solutions to Observed Problems at LRT Crossings

Issue	Possible Solution
<p>1. System design</p> <p>Vehicles driving around closed automatic gates.</p>	<p>Install raised medians with barrier curbs.</p> <p>Install channelization devices (tubular posts, vertical delineators).</p> <p>Install longer automatic gate arms.</p> <p>Photo enforcement.</p> <p>Four-quadrant gates.</p> <p>For parallel traffic, install protected signal indications or LRV-activated “NO RIGHT/LEFT TURN” signs (R3-1, 2).</p> <p>For parallel traffic, install turn automatic gates.</p>
<p>LRV operator cannot visually confirm if gates are working.</p>	<p>Install gate indication signals or in-cab wireless video link.</p> <p>Install and monitor at a central control facility a Supervisory Control and Data Acquisition system.</p>
<p>Slow trains share tracks/ crossings with LRVs and near-side LRT station stops.</p>	<p>Constant warning time. Use gate delay timers.</p>

Issue	Possible Solution
Motorist disregard for regulatory signs at LRT crossings and crossing warning devices.	Avoid excessive use of signs. Photo enforcement.
Motor vehicles queue back across LRT tracks from a nearby intersection controlled by STOP signs (R1-1).	Allow free flow (no STOP sign) off the tracks or signalize intersection and interconnect with crossing.
Sight distance limitations at LRT crossings.	Maximize sight distance by limiting potential obstructions to 3.5 feet in height within about 100 to 200 feet of the LRT crossing (measured parallel to the tracks back from the crossing).
Motor vehicles queue across LRT tracks from downstream obstruction.	Install “DO NOT STOP ON TRACKS” sign. Install “Keep Clear” zone striping. Install queue cutter signal. [See also “Do Not Block Intersection Markings” from MUTCD Section 3B.17].
Automatic gate and traffic signal interconnect malfunctions.	Install plaque at crossing with 1-800 phone number and crossing name and/or identification number. [See also Emergency Notification Signs from MUTCD Section 8B.19].
2. System operations Freight line converted to, or shared with, light-rail transit.	For new LRT systems, initially operate LRVs slower, then increase speed over time.
Collisions occur when second LRV approaches pedestrian crossing.	When practical, first LRV slows/stops in pedestrian crossing, blocking pedestrian access until second, opposite direction LRV enters crossing.
Motorists disregard crossing warning devices.	Adequately maintain LRT crossing hardware (routinely align flashing-light signals) and reduce device “clutter.”
Emergency preparedness.	Training of staff and emergency response teams (fire, police, EMS).
3. Traffic signal placement and operation Motorists confused about conflicting flashing-light signal and traffic signal indicators.	Use traffic signals on the near side of the LRT crossing (pre-signals) with programmable visibility or louvered traffic signal heads for far-side intersection control. Avoid using cantilevered flashing-light signals with cantilevered traffic signals.
Track clearance phasing.	Detect LRVs early to allow termination of conflicting movements (pedestrians).
Excessive queuing near LRT crossings.	Use queue prevention strategies, pre-signals.
Turning vehicles hesitate during track clearance interval.	Provide protected signal phases for through and turning motor vehicles.
Vehicles queue back from closed gates into intersection.	Control turning traffic toward the crossing.

Issue	Possible Solution
LRT crosses two approaches to a signalized intersection (diagonal crossing).	Detect LRVs early enough to clear both roadway approaches and/or use pre-signals or queue cutter signals. Delay the lowering of the gates that control vehicles departing the common intersection.
Motorists confused about gates starting to go up and then lowering for a second, opposite direction LRV.	Detect LRVs early enough to avoid gate pumping (also allows for a nearby traffic signal controller to respond to a second LRV preemption). At near-side station locations, keep gates raised until LRV is ready to depart.
LRT versus emergency vehicle preemption.	At higher-speed LRT crossings (speeds greater than 55 km/hr. (35 mph)), LRVs receive priority and emergency vehicles second priority.
Turning motorists violate red protected left-turn indication due to excessive delay.	Recover from preemption to phase that was preempted.
With leading left-turn phasing, motorists violate red protected left-turn arrow during preemption.	Switch from leading left-turn phasing to lagging left-turn phasing.
4. Automatic gate placement At angled crossings or for turning traffic, gates descend on top of or behind motor vehicles.	Install gates parallel to LRT tracks. Install advanced traffic signal to control turning traffic.
5. Pedestrian control Limited sight distance at pedestrian crossing.	Install pedestrian automatic gates (with flashing-light signals and bells (or alternative audible device)).
Pedestrians dart across LRT tracks without looking.	Install warning signs. Install swing gates.
Pedestrians fail to look both ways before crossing tracks.	Channel pedestrians (Z-crossings). Paint LRT directional arrow between tracks.
Pedestrians ignore regulatory and warning signs.	Mount signs lower, but in accordance with MUTCD requirements, so they are closer to average eye level for pedestrians. Install active pedestrian warning devices. Provide education and enforcement.
Pedestrians stand too close to tracks as train approaches crossing.	Install pedestrian stop bar with tactile warning outside of the dynamic envelope.
Pedestrians and bicyclists routinely cross the LRT tracks behind the automatic gate mechanism while it is activated.	Install positive control behind the sidewalk (if present) or roadway shoulder.

Source: Korve, Hans W., Brent D. Ogden, Joaquin T. Siques, Douglas M. Mansel, et al. Light Rail Service: Pedestrian and Vehicular Safety. Washington, DC.: Transit Cooperative Research Project Report 69, Transportation Research Board, 2001.

HIGH SPEED RAIL

Special consideration should be given to highway-rail crossings on high-speed passenger train routes. The potential for a catastrophic collision injuring many passengers demands special attention. This not only includes dedicated routes with train speeds over 79 mph, but also other passenger routes over which trains may operate at speeds higher than freight trains, see **Table 11**.

Variations in warning time may occur with high-speed passenger trains at crossings equipped with active crossing warning devices. Because of the wide variation in train speeds (passenger trains versus freight trains), train detection circuitry should be designed to provide the appropriate advance warning for all trains.

All crossings located on high-speed rail corridors should either be closed, grade separated, or if remaining at grade, equipped in accordance with FRA recommended policies summarized below. The train detection circuitry should provide constant warning time. Where feasible, other site improvements may be necessary at these crossings. Sight distance should be improved by clearing all unnecessary signs, parking, and buildings from each quadrant. Vegetation should be periodically cut back or removed. Improvements in the geometries of the crossing should be made to provide the best braking and acceleration distances for vehicles.

The FRA *Highway-Rail Grade Crossing Guidelines for High-Speed Passenger Rail*⁽⁶¹⁾, address the following topics:

- Consolidation and Grade Separation
- Safety Improvements at Private Crossings
- Creation of “Sealed Corridors”
- Warning Systems and Other Highway Traffic Control Devices
- Train Control Integration
- Barrier Systems
- Pedestrian and Trespass Considerations
- Systems Approach

The “Sealed Corridors” approach involves a diagnostic process to assess the appropriate level of safety improvement needed for existing grade crossings which may include closure/consolidation, enhanced warning devices, medians, and grade separation. For public highway-rail grade crossings within a “sealed corridor,” FRA expects highway authorities will consider installing equipment such as (a) four-quadrant gates, (b) three-quadrant gates (exit gate on one side with a 100-foot minimum non-traversable median on opposite side), (c) 100-foot minimum non-traversable medians, or (d) paired one-way streets. Similarly, FRA expects diagnostic teams will evaluate private crossings for closure or treatment with active warning systems, such as flashing-lights and gates or a locked gate system interlocked with the railroad signal system.

Table 11. Potential Tier Structure for Passenger Systems at Highway-Rail Crossings

Tier	I		II	III	
Service Description	Feeder	Regional		Core Express	Core Express
Speed Range (mph)	0–90	91–110	111–125	126–150	126–220
Other Traffic Allowed on Same Track	Mixed Use (passenger and freight)	Mixed Use	Mixed Use	Mixed Use	Dedicated ROW
Maximum Track Class	Class 5	Class 6	Class 7	Class 8	Class 9
Signals and Train Control	PTC	PTC + vital perimeter protection	PTC + vital perimeter protection	PTC + HSR-125	PTC + HSR-125
Public Highway—Rail Grade Crossing Treatments	Automated warning; supplementary measures or sealed corridor treatments where necessary	Sealed corridor; evaluate need for presence detection and PTC feedback	Barrier/warning systems required per §213.247; Presence detection tied to PTC	None above 125 mph	None above 125 mph
Private Highway—Rail Grade Crossing Treatments	Automated warning or manually locked gate preferred; cross-buck and stop or yield sign where conditions permit	Automated warning or locked gate with signal interlock	Barrier/warning systems required per §213.247; Presence detection tied to PTC	None above 125 mph	None above 125 mph

Source: Highway-Rail Grade Crossing Guidelines for High-Speed Passenger Rail, FRA, 2009, as updated to reflect subsequent changes in FRA allowable maximum speeds.

Special attention should be given to the interconnection of grade crossing warning systems with other traffic control systems, where applicable. This is to ensure that the traffic/railroad preemption timing is sufficient to safely clear vehicular traffic away from the crossing prior to the activation of the grade crossing flashing-lights and gates. A traffic engineering study should be conducted to determine the appropriate timing for the interconnection; whether the interconnection should be simultaneous or advanced preemption. The use of pre-signals and queue-cutter signals should also be explored where warranted.

Vehicle Presence Detection (VPD) technology should be considered when four-quadrant gates are present. At highway-rail grade crossings that are near highway-highway crossings, with vehicular storage constraints present, VPD should be provided in connection with the train control system when train speeds above 100 mph are present with crossings equipped with non-traversable medians.

As stated in the 2009 *Highway-Rail Grade Crossing Guidelines for High-Speed Passenger Rail*, the use of Remote Health Monitoring (RHM) technology at grade crossings on high-speed rail lines is clearly indicated. RHM allows immediate reporting to the railroad signal's trouble desk (or railroad dispatcher) when an intermittent malfunction or a complete failure of the grade crossing signaling system occurs. RHM provides for the continuous monitoring of the crossing system's health performance. Once a failure is detected and reported, the system enables responsive action by dispatchers, train crews, and signal maintainers to diagnose and correct the problem.

Special signing might also be employed at these crossings to remind the public that the crossings are used by high-speed trains. The signing should be in conformance with the guidelines provided in MUTCD Section 8B.20, see **Figure 64**.



Figure 64. Train Speed Warning Sign

Source: Manual on Uniform Traffic Control Devices, 2009 Edition. Figure 5F-1 Highway-Rail Grade Crossing Signs and Plaques for Low-Volume Roads, Washington, DC, FHWA, 2009.

TRUCKS AND BUSES

Highway-rail crossings are designed and controlled to accommodate the vehicles that use them. Trucks and buses have unique characteristics that should be considered. The following describes the additional evaluation and design taken into consideration for trucks and buses at crossings.

Trucks with Hazardous Material Cargo

Crossings used by vehicles with hazardous material cargo should be considered for improvements and, in turn, these improvements should consider the special needs of these vehicles.

Based upon various NTSB studies of collisions involving trucks including those carrying hazardous materials, the following guidance should be considered:

- Trucks carrying bulk hazardous material should use routes that have grade separations or active control devices. Where routes that have crossings with only passive control devices are near terminals, the crossings should be considered for upgrading to active control.
- Ensure that active warning devices are activated with enough “warning time” (activation in advance of the arrival of a train) so that trucks have the available distance required for stopping. Also, for vehicles stopped at the crossing when signals are not operating, adequate warning time should be provided for clearance of tracks by loaded trucks before the arrival of a train.
- If feasible, where there is an intersection near the crossing, increase the storage space (defined as the “clear storage distance” in MUTCD) between the tracks and the intersecting highway. If on a direct route to a truck terminal, also consider giving ROW to the critical movement through control measures.
- Promote a program of education and enforcement to reduce the frequency of hazardous driving and alert the driver of potential danger. Driver training and education programs such as Operation Lifesaver should be expanded to include a specific program that addresses the problems.
- At crossings where a significant volume of trucks is required to stop, consideration should be given to providing a pull-out lane. These auxiliary lanes allow trucks to come to a stop and then to cross and clear the tracks without conflicting with other traffic. Hence, they minimize the likelihood of rear-end collisions or other vehicle-vehicle collisions. They would be appropriate for two-lane highways or for high-speed multilane highways.

Buses

Because buses carry many passengers and have performance characteristics like large trucks, these vehicles also need special consideration. Many of the measures suggested for trucks with hazardous material apply to buses. Railroad-highway crossings should be taken into consideration when planning school bus routes.

Potentially hazardous crossings, such as those with limited sight distance or horizontal or vertical alignment issues, should be avoided if possible. Crossings along school bus routes should be evaluated by the appropriate highway personnel to identify the need for improvements. Drivers should be instructed on safe crossing procedures and routes.

In addition to the recommendations that apply to trucks with hazardous cargo, the following should be considered when evaluating crossings where buses are likely to cross regularly:

- Special training for bus drivers
- Pavement markings and stop lines to delineate where buses should stop when checking for possible on-coming trains

Long and Heavily Laden Trucks

Large trucks have problems at crossings because of their length and performance characteristics. Longer clearance times are required for longer vehicles and those slow to accelerate. Also, longer braking distances become necessary when trucks are heavily laden, thus reducing their effective braking capability.

As truck sizes, configurations, and weights have increased over time, it is critical to address currently allowable large vehicles (such as the interstate semitrailer truck—WB-62 or WB-65), where such vehicles may be expected to utilize a highway-rail crossing on a regular basis. Consequently, when considering improvements, the designer should be aware of and design for the amount and type of current and expected truck traffic. Areas that should be focused upon include the following:

- Longer sight distances
- Placement of advance warning signs
- Warning time for signals
- Approach and departure grades
- Storage area between tracks and nearby highway intersection

BICYCLES AND MOTORCYCLES

The configuration of each trail-rail intersection is unique. There are available reference guides, but solutions should be adapted to site conditions using standard treatments, where applicable. The FRA, State DOTs, and Class 1 railroads are working to close existing at-grade rail crossings to reduce liability, exposure, and incidents.

To enhance visibility of the trail-rail intersection for approaching cyclists and other trail users, advance notice of the crossing should be displayed via pavement markings and signage. Allowing the cyclists enough time to assess the situation and choose whether to clear the intersection or stop prior to entering the crossing. The angle of the trail-rail crossing is another critical issue. Right-angle crossings are preferred. Where unable to meet these criteria (crossing angle is less than 45 degrees) additional width should be provided near the crossing. **Figure 65** illustrates this guidance.

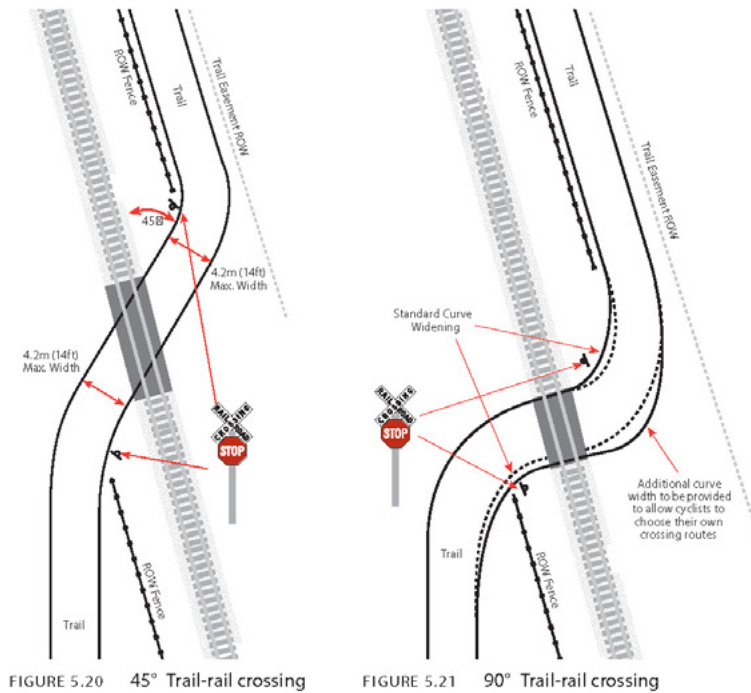

Figure 65. Design for Degree of Trail-Rail Crossing

Source: Adapted from Rails-with-Trails: Lessons Learned, Literature Review, Current Practices, Conclusions, USDOT, FTA, FHWA, FRA, August 2002.

The crossing surface type will likely impact cyclists as well. Depending on the angle and type of crossing, a cyclist may lose control if the wheel becomes trapped in the flangeway. The surface materials and the flangeway width and depth should be evaluated. The more the crossing deviates from the ideal 90-degree crossing, the greater the potential for a cycle wheel to be trapped in the flangeway. If the crossing angle is less than 45 degrees, consideration should be given to widening the bikeway to allow sufficient width to cross the tracks at a safer angle.

For signing and markings at a crossing intended for use by bicyclists, refer to **Figure 48**, which shows the MUTCD treatment for a pathway crossing.

ITS

ITS extends into applications that can be implemented at railroad crossings and within vehicles which will affect traffic signal preemption. Typically, trains have the ROW at crossings, and the crossings are managed to maximize safety of all users while minimizing delay to roadway traffic. This involves the coordination of railroad active safety devices with highway traffic signals, as well as the dissemination of crossing status information to aid in route planning. The advancement of ITS applications can enhance these capabilities for all parties involved.

ITS National Architecture and User Service 30

Per FHWA, “National ITS Architecture (also “national architecture”) means a common framework for ITS interoperability. The National ITS Architecture comprises the logical architecture and physical architecture which satisfy a defined set of user services. The National ITS Architecture is maintained by the USDOT and is available on the DOT website.⁽⁶²⁾

The FHWA, in conjunction with FRA, has developed “User Service 30” to describe the ITS applications that relate to the highway-rail crossing. These ITS applications have been defined in the National ITS Architecture, which is a framework for developing integrated transportation systems. The National ITS Architecture defines a set of “subsystems,” “terminators,” and “architecture flows” that describe the transfer of information between ITS systems.

Subsystems are the building blocks of the National ITS Architecture that perform the ITS functions identified in 33 user services (which include the highway-rail crossing user service). Terminators are systems that interface with the ITS systems. Architecture flows are the definition of the information that is passed between subsystems or between subsystems and terminators. In the context of the National ITS Architecture, highway-rail crossing functions are identified with the following three interfaces (refer to **Figure 66**):

- Roadway subsystem and the wayside equipment terminator
- Traffic management subsystem (TMS) and the rail operations terminator
- Highway-rail intersection data, traffic management to roadway

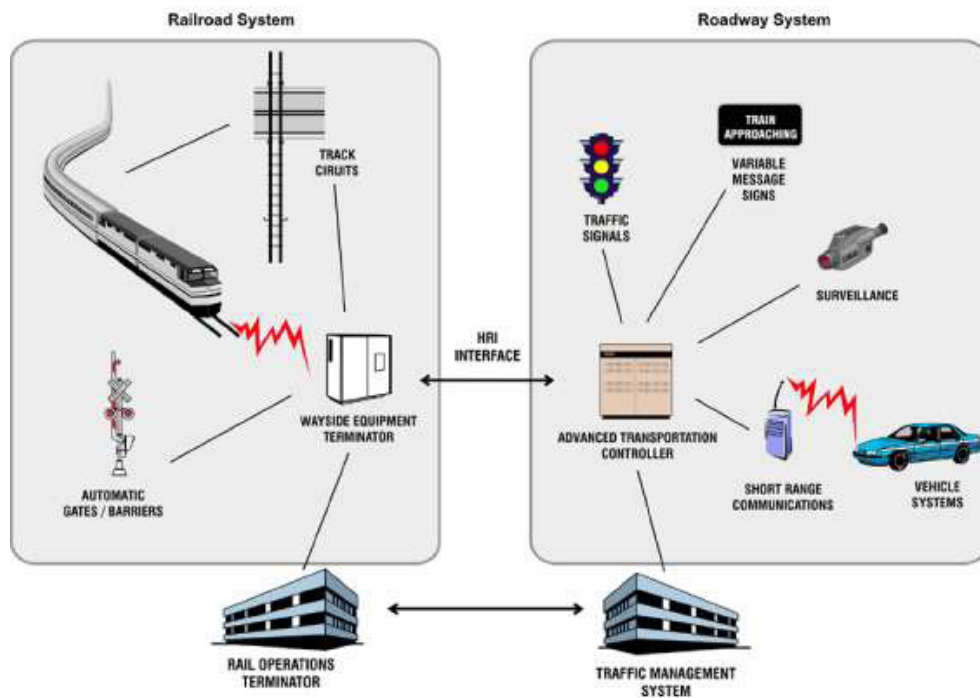

Figure 66. Highway Rail Intersection Interface Overview

Source: The National Architecture for ITS, USDOT.

Roadway subsystem and the wayside equipment terminator. The roadway subsystem represents ITS field equipment, including traffic control signal controllers. The wayside equipment terminator represents train interface equipment (usually) maintained and operated by the railroad and (usually) physically located at or near a crossing. The roadway subsystem interface with the railroad wayside equipment will provide crossing status and blockage notification to wayside equipment and, conversely, real-time information about the approach (actual or predicted) of a train to the roadway subsystem. The interface operates as follows:

- The roadway subsystem sends the real-time crossing status to the wayside equipment. This includes a confirmation that the crossing is closed (gates are down) and that trains may proceed at full authorized speed.
- The roadway subsystem also sends a real-time indication of intersection blockage. This message would be used to provide the information needed by the wayside equipment to alert the train to reduce speed or stop.
- The wayside equipment provides a real-time indication of its operational status via the track status flow. This would alert the roadside equipment to possible failures or problems in the wayside equipment. The track status flow also includes the simple binary indication of a train approaching, which is currently used when traffic control signal controller units are interconnected with the wayside equipment.
- In future implementations, the wayside equipment would provide expected time of arrival and length of closure via an arriving train information flow.

TMS and the rail operations terminator. The interface between the rail operations terminator and TMS provides for the exchange of management or near real-time data between these two key functions.

- The rail operations function will send information to the TMS to support forecasting of crossing closures. This includes train schedules and crossing maintenance schedules. In addition, the rail operations function will send to the TMS information about rail incidents that may impact vehicle traffic. This latter information would be in near real time; other schedule information would be provided on a periodic basis (such as daily).
- The TMS would notify the rail operations function in near real time about equipment failure, intersection blockage, or other incident information (such as a nearby hazardous material spill). The TMS would also send information about planned maintenance activities occurring at or near the crossing that would impact the railroad ROW.

Roadway subsystem and TMS. Beginning in 2011, FRA began researching connected vehicle concepts appropriate for highway-rail crossings. The primary objective of this research is to explore the feasibility of in-vehicle safety concepts capable of providing an alert of an approaching train to a highway vehicle approaching a highway-rail crossing. The technology is intended to be deployed at any highway-rail crossing where benefit would be accrued by increasing situational awareness to minimize safety related incidents or improving the flow of roadway traffic.

A set of the following potential scenarios were initially identified and evaluated for future implementation:

Highway-rail crossing equipped with active warning devices. Connected vehicle roadside equipment is activated by the highway-rail crossing signaling system preemption signal by means of a hardwire interconnection. Approaching highway vehicles received alerts over the connected vehicle Dedicated Short Range Communications (DSRC) communications channel.

Trains equipped with advanced technology. This scenario would utilize emerging train positioning technology. Connected vehicle roadside equipment could receive train location information over the 220MHz communications network and provide alerts to approaching highway vehicles over the connected vehicle DSRC communications channel.

Highway-rail crossing not equipped with active warning devices. A train is equipped with connected vehicle onboard equipment that allows it to transmit over a DSRC communications channel directly with highway vehicles. This is the only scenario that is dependent upon the installation of connected vehicle technology on trains.

To this end, FRA has been exploring the feasibility of the first scenario and has developed concept of operations and system requirements documents to support this approach. Proof-of-concept testing was performed in 2017 on a DSRC-based platform, but the effort remains in the exploratory phase.

Standard 1570

The Institute of Electrical and Electronics Engineers (IEEE) empaneled a working group that developed IEEE Standard 1570, “Standard for the Interface Between the Rail Subsystem and the Highway Subsystem at a Highway Rail Intersection.”⁽⁶³⁾ This standard was developed to coordinate information transfer between the two with emphasis on digital data communication and to enable interoperability among the various types of equipment.

QUIET ZONES

Overview

The FRA regulations on quiet zones allow localities nationwide to mitigate the effects of train horn noise, while maintaining a high level of safety at grade crossings located within quiet zones.⁽⁵⁾ These regulations were developed to provide a consistent approach nationwide to enable local jurisdictions to establish quiet zones without compromising safety. They address use of the horn at public highway-rail grade crossings.

The public authority responsible for traffic control or law enforcement at the highway-rail grade crossing is the only entity authorized to establish a quiet zone.

FRA regulations on quiet zones:

- Define engineering solutions known as “supplementary safety measures” (SSMs) for use at highway-rail grade crossings without FRA approval.

- Provide explicit flexibility for the modification of SSMs to receive credit as “alternative safety measures” (ASMs).
- Include a provision that provides risk reduction credit for pre-existing SSMs and pre-existing modified SSMs that were implemented prior to December 18, 2003.
- Allow use of education and enforcement options, including photo enforcement, subject to verification of effectiveness.

Public authorities may establish quiet zones in which train horns will not be routinely sounded at grade crossings. The details for establishment of quiet zones differ depending on the type of quiet zone to be created (pre-rule or new) and the type of safety improvements to be implemented (if needed).

FRA regulations governing quiet zones (49 CFR Part 222) also:

- Allow establishment of quiet zones that prohibit sounding of horns during the nighttime hours only. These quiet zones are referred to as partial quiet zones.
- Require diagnostic team reviews of pedestrian crossings and private crossings that provide access in active industrial or commercial sites, if the pedestrian and private crossings are located within proposed new quiet zones.
- Require that public authorities retain automatic bells at public highway-rail grade crossings subject to pedestrian traffic.
- Require public authorities to provide notification of their intent to create a new quiet zone. During the 60-day period after the Notice of Intent is mailed, comments may be submitted to the public authority.
- Require that public highway-rail grade crossings located within a Quiet Zone comply with applicable MUTCD provisions.

Once a quiet zone is established, the railroad is generally barred from routine sounding of the horn at the affected grade crossings. However, railroads remain free to use the horn for other purposes as prescribed in railroad operating rules on file with FRA. In addition, railroads must use the horn as specified in other FRA regulations (see 49 CFR 222.23), even within quiet zones.

The FRA provides a web-based tool for communities to use in performing “what if” calculations and preparing submissions necessary to create or retain quiet zones. This tool, the [Quiet Zone Calculator](#), may be found on FRA’s website.⁽⁶⁴⁾

The FRA regional personnel are available to participate in diagnostic teams evaluating options for quiet zones.

Requirement to Sound the Locomotive Horn

Outside of quiet zones, railroads must sound the horn 15–20 seconds prior to a train’s arrival at a public highway-rail grade crossing, but not more than one-quarter-mile in advance of the crossing (49 CFR 222.21).

Note: Before 49 CFR Part 222 was issued, State laws and railroad rules generally required that the locomotive horn begin sounding from a point one-quarter-mile in advance of the highway-rail grade crossing and continue sounding until the crossing is occupied by the lead locomotive of a train. For trains operating at less than 45 miles per hour, FRA's current regulations in 49 CFR Part 222 reduce the time and distance over which the horn is sounded, thereby reducing noise impacts on local communities.

The required pattern for sounding the horn is two long, one short, and one long blast repeated or prolonged until the lead locomotive occupies the public highway-rail grade crossing. Train operators may vary this pattern as necessary where public highway-rail grade crossings are closely spaced; they are also authorized (but not required) to sound the horn in the case of an emergency, even in a quiet zone.

The FRA regulations in 49 CFR 229.129 also prescribe a minimum and a maximum volume level for the train horn. The minimum level is 96 dB(A), and the maximum volume level is 110 dB(A).

Creation of Quiet Zones

The rule provides significant flexibility to communities to create quiet zones. This flexibility extends to communities that had existing whistle bans, as well as other communities that previously did not have an opportunity to restrict locomotive horn sounding at grade crossings.

It should be noted that 49 CFR Part 222 permits implementation of quiet zones in low-risk locales without requiring the addition of safety improvements.

- This concept utilizes a risk index approach that estimates expected safety outcomes (that is, the likelihood of a fatal or non-fatal casualty resulting from a collision at a highway-rail crossing including the existing risk caused by the absence of the sounding of the locomotive horn)
- Risk is averaged over the public highway-rail grade crossings in a proposed quiet zone. This averaged risk is called the Quiet Zone Risk Index (QZRI)
- The QZRI within the proposed quiet zone is then compared with the average nationwide risk at gated public highway-rail grade crossings where the horn is sounded (the "Nationwide Significant Risk Threshold" [NSRT]). FRA periodically revises the NSRT

The effect of this approach is that it may be possible to establish quiet zones without significant expense if flashing-lights and gates are already in place at the public highway-rail grade crossings. Typically, these quiet zones have few trains traveling at low speeds.

If the QZRI for a proposed new quiet zone exceeds the NSRT and the level of risk when horns are routinely sounded within the proposed quiet zone, SSMs or ASMs will need to be used to reduce that risk (to fully compensate for the absence of the train horn or to reduce risk to a level below the NSRT).

Establishment of New Quiet Zones

New quiet zones may be established if all public highway-rail grade crossings within the proposed quiet zone are equipped with flashing-lights and gates; and either of these following specifications:

- The QZRI within the proposed quiet zone is less than the NSRT
- SSMs are present at each public highway-rail grade crossing
- Safety improvements (SSMs or ASMs) are made to compensate for loss of routine sounding of the train horn
- Safety improvements (SSMs or ASMs) are made to reduce the QZRI within the proposed quiet zone to a level below the NSRT

Note: FRA regulations (49 CFR 222.35) require that the active warning system at each public highway-rail grade crossing within a quiet zone consist of flashing-lights and gates be equipped with power-out indicators, which provides information on the presence of commercial electrical power at the crossing. FRA regulations also require that the active crossing warning system be equipped with constant warning time train detection, if reasonably practical. Detailed instructions for establishing a quiet zone are available on FRA's website.⁽⁶⁵⁾

Length of Quiet Zones

FRA regulations require that a quiet zone be at least one-half-mile in length and include at least one public highway-rail grade crossing. (See 49 CFR sections 222.9 and 222.35 for more information.)

Supplemental and Alternative Safety Measures

Supplemental Safety Measures (SSMs) are engineering improvements that have been determined by FRA to be an effective substitute for the train horn. If employed at every public highway-rail grade crossing in the quiet zone, the public authority can establish the quiet zone by designation without prior FRA approval (subject to reporting requirements). They also may be used at some public highway-rail grade crossings in a proposed quiet zone to fully compensate for the lack of warning provided by the train horn or to reduce existing risk levels to a level below the NSRT. SSMs include the following:

- Temporary closure of a public highway-rail grade crossing (for partial quiet zone only)
- Permanent closure of a public highway-rail crossing
- Four-quadrant gates
- Gates with traffic channelization arrangements (for example, non-mountable curb or mountable curb with delineators) at least 100 feet in length on each side of the crossing (or 60 feet where there is an intersecting roadway) and no commercial or industrial driveways located within 60 feet of the gate arm.
- One-way street with gate(s) across all approaching roadway lanes

Alternative Safety Measures (ASMs) may also be applied to reduce existing risk levels at one or more public highway-rail grade crossings within a proposed quiet zone. The public authority must apply (per 49 CFR 222.39(b)) to FRA for approval of the effectiveness rate that will be assigned to each ASM proposed for use at public highway-rail grade crossings in the quiet zone. ASMs include the following:

- Any modified SSM (such as crossing gates with traffic channelization less than 60 feet in length)
- Education and/or enforcement programs (including photo enforcement) with verification of effectiveness
- Engineering improvements, other than modified SSMs
- Combination of the above

FRA regulations provide that pre-existing SSMs and pre-existing modified SSMs can also be counted toward risk reduction.

Automated Wayside Horn

49 CFR Part 222 authorizes use of the automated wayside horn at highway-rail grade crossings equipped with flashing-lights and gates (inside or outside a quiet zone) as a one-to-one substitute for the train horn.

The MUTCD Section 8C.07 provides guidance on Wayside Horn Systems at crossings.

Special Circumstances

A public authority or railroad seeking relief from a regulatory provision in 49 CFR Part 222 may request a waiver from the provision from FRA.

A railroad or public authority seeking a waiver from a regulatory provision in 49 CFR Part 222 must first consult with the other party to find out whether the other party would be willing to submit a joint waiver request. If agreement to file a joint waiver petition cannot be achieved, the party may still request the regulatory relief by a waiver, provided the waiver petition reflects the efforts of the submitting party to reach agreement with the other party and explains why a joint waiver petition would not be likely to contribute significantly to public safety.

The FRA may grant waivers if in the public interest and consistent with the safety of highway and railroad users of the highway-rail crossings.

EDUCATION AND ENFORCEMENT

This *Handbook* presents guidance and standards which are applied to develop engineered treatments intended to improve safety and operations at crossings. Sound engineering is fundamental to safety. It is acknowledged that the synergy of the “Three E’s—Engineering, Education, and Enforcement” maximizes the benefits of engineering treatments. It is beyond the scope of this *Handbook* to provide an in-depth presentation of materials on education and enforcement, but practitioners should be aware that initiatives in these areas are fundamental to maximizing safety at crossings.

Education

Education on crossing safety at the national level is provided by Operation Lifesaver, Inc. (OLI) as well as several Federal agencies. The OLI is a nonprofit public safety and awareness organization established in 1972, which provides educational resources, public awareness materials and

community involvement activities focused on crossing safety. The OLI engages volunteers who provide training on rail crossing safety. The OLI also partners with emergency responders and local law enforcement to support initiatives to promote crossing safety. The OLI partners with the USDOT in supporting “Rail Safety Week.” The first U.S. Rail Safety Week was held on September 24–30, 2017. This effort was timed to occur with the beginning of the school year when other safety initiatives take place. More information on OLI, its activities and materials can be found at its website at <https://oli.org/>.

Transit districts across the country promote education on crossing safety. Large urban transit districts also develop and disseminate safety-related materials within their districts using a wide range of venues. Examples include the Chicago Transit Authority “It’s Not Worth Your Life. Stay off the Tracks” campaign⁽⁶⁶⁾, New York MTA’s “Wait for the Gate” campaign⁽⁶⁷⁾, and Los Angeles Metro, which has developed a series of “Safetyville” videos using stick figure animation to deliver graphic reminders of transportation-related safety hazards and consequences of risky behavior.⁽⁶⁸⁾

Enforcement

Crossing collisions occur less frequently than collisions involving highway vehicles, bicycles, motorcycles, or pedestrians, and risky behavior at a crossing does not necessarily entail a legal violation. Local initiatives and targeted enforcement campaigns have been used to enhance crossing safety. A recent example was an “enforcement blitz” conducted in Portage County, WI, involving the State patrol, local police and CN railroad police in May 2018.⁽⁶⁹⁾

The Volpe Center prepared an in-depth study of enforcement campaigns in the Public Education and Enforcement Research Study (USDOT, December 2006).⁽⁷⁰⁾ The Public Education and Enforcement Research Study (PEERS) assessment describes two local initiatives and success factors. Improved safety was identified in the Arlington Heights, IL, initiative characterized by commuter train operations and a population of repeat crossing users versus Macomb, IL, where the rail traffic was predominantly long freight trains and the population more variable.

A. APPENDIX—BACKGROUND

INTRODUCTION

The highway-rail grade crossing is unique in that it constitutes the intersection of two transportation modes which differ in both the physical characteristics of their traveled ways and their operations.

Railroad transportation in the United States had its beginning during the 1830s and became a major factor in accelerating the great westward expansion of the country by providing a reliable, economical, and rapid method of transportation. Today, railroads are major movers of coal, ores, minerals, grains, and other farm products; chemicals and allied products; food and kindred products; lumber and other forest products; motor vehicles and equipment; and other bulk materials and products.

In addition, railroads contribute to the movement of non-bulk intermodal freight, which also moves by water and highway during the journey from origin to destination. Finally, although few privately-operated passenger services operate on Class I railroads, publicly-funded long distance, corridor, and commuter services as well as light-rail transit (LRT) lines all may operate through grade crossings.

The number of railroad line miles grew until a peak was reached in 1920, when 252,845 miles of railroad line were in service. Line Miles are defined as the actual length of the corridor within which the track is located. Track miles are defined as the total centerline length of mainline trackage in a corridor (Railroad Facts, 2017).⁽⁷¹⁾ The number of railroad line miles and track miles has been decreasing since the 1930s, as shown in **Table A-1**.

Highway-rail grade crossings became more of a concern with the advent of the automobile in the early 1900s. Vehicle Miles Traveled (VMT) increased from 47.6 billion in 1920 to approximately 3.2 trillion by 2016. US lane miles totaled approximately 8.7 million by 2016.⁽⁷²⁾

The number of highway-rail grade crossings grew with the increase in highway miles. In many cities and towns, the grid method of laying out streets was utilized, particularly in the Midwest and west. A crossing over the railroad was often provided for every street, resulting in about 10 crossings per mile. As of July 2015, there are 211,631 highway-rail crossings, 58.5 percent are public, 40.4 percent are private, and 2 percent are pedestrian.⁽⁷³⁾

Crossings are divided into categories. Public crossings are those on highways under the jurisdiction of, and maintained by, a public authority and open to the traveling public. In 2017, there were 164,604 public crossings, of which 128,878 were at grade and 35,726 were grade separated. Private crossings are those on roadways privately owned and utilized only by the landowner or tenant. There were 83,415 private crossings in 2017. Pedestrian crossings are those used solely by pedestrians. There were 4,376 pedestrian crossings in 2017.⁽⁷⁴⁾ Please note that since the Inventory form revision in 2015, crossings can now be marked as public or private and highway or pedestrian, rather than public, private or pedestrian.

Table A-1. Class 1 Railroad Line Miles and Track Miles

Year	Line miles	Track miles
1929	229,530	381,417
1939	220,915	364,174
1947	214,486	355,227
1955	211,459	350,217
1960	207,334	340,779
1970	196,479	319,092
1980	164,822	270,074
1990	119,758	200,074
2000	99,250	168,535
2002	100,125	170,048
2003	99,126	169,069
2004	97,662	167,312
2005	95,830	164,291
2006	94,942	162,056
2007	94,440	161,114
2008	94,209	160,734
2009	94,048	160,781
2010	95,700	161,926
2011	95,514	162,393
2012	95,391	162,306
2013	95,235	161,980
2014	94,372	161,240
2015	93,628	160,692
2016	93,339	160,141

Source: Railroad Facts, page 47, Washington, DC, Association of American Railroads, 2017.

Sixty percent, or 77,214, of public at-grade crossings were in rural areas, compared to 50,195 in urban areas. For both urban and rural areas, most crossings are located on local roads, as depicted in **Table A-2**. Twenty-two percent of public at-grade crossings are located on federal-aid highways, as shown in **Table A-3**.

Table A-2. Public At-Grade Crossings by Functional Classifications, 2017

Functional Classification	Number
Rural	
Interstate*	69
Other principal arterial	1,095
Minor arterial	3,200
Major collector	10,871
Minor collector	7,367
Local	54,570
Other freeways and expressways	23
Not reported	19
Total—Rural	77,214
Urban	
Interstate*	129
Other principal arterial	4,711
Minor arterial	9,126
Major Collector	10,158
Minor Collector	282
Local	25,477
Other freeways and expressways	214
Not reported	98
Total—Urban	50,195
Total not reported as Rural or Urban	1,469
Grand Total	128,878

**Note: Crossings classified as “Interstate” are typically located on ramps.
Source: Unpublished data from Federal Railroad Administration.*

Table A-3. Public At-Grade Crossing by Highway System, 2017

Highway System	Number
Interstate Highway System	151
Federal-aid, not National Highway System	28,001
Non-federal-aid	93,830
Other National Highway System	4,778
Not reported	2,118
Total	128,878

**Note: Crossings classified as “Interstate” are typically located on ramps.
Source: Unpublished data from Federal Railroad Administration.*

KEY STATISTICS

Safety and Operations at Highway-Rail Grade Crossings

National statistics on crossing collisions have been kept since the early 1900s resulting from the requirements of the Accident Reports Act of 1910. The act required rail carriers to submit reports of collisions involving railroad personnel and railroad equipment, including those that occurred at crossings. Since this time, the Federal Rail Administration (FRA) Office of Railroad Safety developed the *FRA Guide for Preparing Accident/Incident Reports*, which includes a section on reporting thresholds for accidents/incidents. The reporting threshold is updated annually, so users should check the latest information regarding these thresholds. This information can be accessed online at this link: (<https://safetydata.fra.dot.gov/OfficeofSafety/publicsite/ProposedFRAGuide.aspx>). Figure A-1 shows data for the past 10 years.

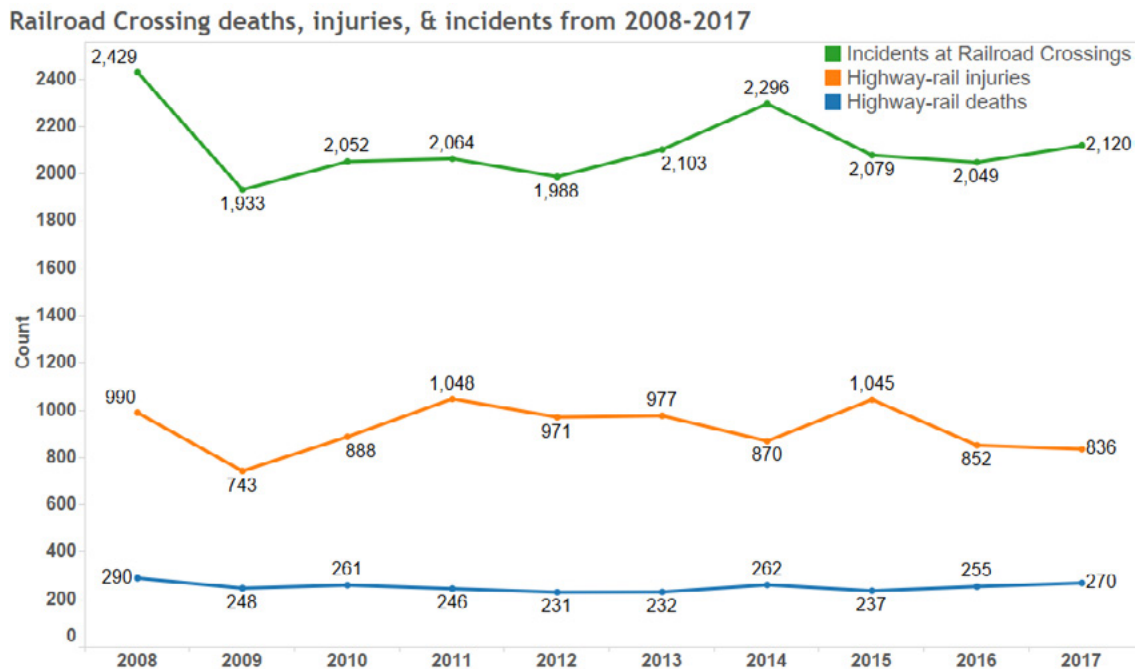

Figure A-1. Railroad Crossing deaths, injuries, and incidents from 2008–2017

Source: USDOT FRA, *Safety Data Statistic of Railroad Crossing deaths, injuries, & incidents from 2008–2017*. Data from Report 1.12. <https://www.fra.dot.gov/Page/P0855>.

These reporting requirements remained essentially the same until 1975, when the FRA redefined the threshold for a reportable highway-rail grade crossing collision. Under the new guidelines, any impact “between railroad on-track equipment and an automobile, bus, truck, motorcycle, bicycle, farm vehicle, pedestrian or other highway user at a rail-highway crossing” was to be reported.⁽⁷⁵⁾

Table A-4 gives the number of fatalities occurring at public highway-rail grade crossings from 1920 to 2017. Also, shown separately, are fatalities resulting from collisions involving motor vehicles. **Table A-5** provides data on the number of collisions, injuries, and fatalities at public highway-rail grade crossings for the period from 1975 to 2017. Collisions and injuries from 1920 to 1974 are not provided because not all collisions and injuries were required to be reported during those years.

The variation in the number of motor vehicle fatalities appears to be related to various occurrences over the years. From 1920 to 1930, railroad expenditures for the construction of grade separations and crossing active traffic control devices were extensive. During the early four-year period of the depression, railroad expenditures for crossing improvements lagged, and the number of motor vehicle fatalities increased. Starting in 1935, some special federal programs were initiated to improve crossing safety, and the number of motor vehicle fatalities began to decrease. During the wartime 1940s, crossing improvement work was reduced, and the number of motor vehicle fatalities remained constant. Since 1946, federal aid has increased.

During the period between 1960 and 1967, the number of fatalities increased despite continual federal funding for grade separations and crossing traffic control device improvements. A national concern for crossing safety developed, as witnessed by national conferences to address the increase in casualties. The U.S. Congress responded by establishing a categorical funding program for crossing safety improvements in the 1973 Highway Act. This categorical safety program was extended in the 1976 Highway Act and the 1978 and 1982 Surface Transportation Acts. The result of this safety program and other emphases on crossing safety is demonstrated in **Table A-4**, which shows the dramatic reduction in the number of fatalities involving motor vehicles.

Approximately 6.3 million motor vehicle traffic collisions occurred in 2015. Crossing collisions accounted for less than 0.05 percent of all motor vehicle collisions on roads; however, the severity of crossing collisions demands special attention. In 2015, there were 153 motor vehicle fatalities at crossings and a total of 32,539 motor vehicle fatalities. Therefore, crossing fatalities accounted for 0.5 percent of all motor vehicle fatalities. 0.5 percent of vehicle collisions resulted in a fatality, but 8 percent of crossing collisions resulted in a fatality.^(76,77) In 2017, 821 fatal incidents occurred involving rail. A large portion of these fatalities involved trespassers.⁽⁷⁸⁾

In addition to the possibility of a collision between a train and a highway user, a highway-rail grade crossing presents the possibility of a collision that does not involve a train. Non-train collisions include collisions in which a vehicle that has stopped at a crossing is hit from the rear; collisions with fixed objects such as signal equipment or signs; and non-collision accidents in which a driver loses control of the vehicle.

Most collisions with trains involve mainline freight operations, as shown in **Table A-6**.

Table A-4. Fatalities at Public Crossings, 1920–2017

Year	All Fatalities	Motor Vehicle Fatalities	Year	All Fatalities	Motor Vehicle Fatalities	Year	All Fatalities	Motor Vehicle Fatalities
1920	1,791	1,273	1953	1,494	1,328	1986	578	507
1921	1,705	1,262	1954	1,303	1,161	1987	598	533
1922	1,810	1,359	1955	1,446	1,322	1988	652	594
1923	2,268	1,759	1956	1,338	1,210	1989	757	682
1924	2,149	1,688	1957	1,371	1,222	1990	648	568
1925	2,206	1,784	1958	1,271	1,141	1991	565	497
1926	2,491	2,062	1959	1,203	1,073	1992	536	466
1927	2,371	1,974	1960	1,364	1,261	1993	584	517
1928	2,568	2,165	1961	1,291	1,173	1994	572	501
1929	2,485	2,085	1962	1,241	1,132	1995	524	455
1930	2,020	1,695	1963	1,302	1,217	1996	449	377
1931	1,811	1,580	1964	1,543	1,432	1997	419	378
1932	1,525	1,310	1965	1,534	1,434	1998	385	325
1933	1,511	1,305	1966	1,780	1,657	1999	363	309
1934	1,554	1,320	1967	1,632	1,520	2000	369	306
1935	1,680	1,445	1968	1,546	1,448	2001	386	315
1936	1,786	1,526	1969	1,490	1,381	2002	316	271
1937	1,875	1,613	1970	1,440	1,362	2003	300	249
1938	1,517	1,311	1971	1,356	1,267	2004	333	256
1939	1,398	1,197	1972	1,260	1,190	2005	329	258
1940	1,808	1,588	1973	1,185	1,077	2006	325	267
1941	1,931	1,691	1974	1,220	1,128	2007	299	227
1942	1,970	1,635	1975	888	786	2008	266	199
1943	1,732	1,396	1976	1,066	978	2009	226	161
1944	1,840	54	1977	944	846	2010	226	136
1945	1,903	1,591	1978	1,018	926	2011	211	138
1946	1,851	1,575	1979	834	727	2012	199	135
1947	1,790	1,536	1980	788	708	2013	207	141
1948	1,612	1,379	1981	697	623	2014	235	144
1949	1,507	1,323	1982	580	526	2015	208	127
1950	1,576	1,410	1983	542	483	2016	227	129
1951	1,578	1,407	1984	610	543	2017	241	139
1952	1,407	1,257	1985	537	480			

Source: Data from the Federal Railroad Administration.

Table A-5. Collisions, Fatalities, and Injuries at Public Crossings, 1975–2017

Year	Collisions	Fatalities	Injuries
1975	11,409	888	3,736
1976	12,374	1,066	4,535
1977	12,595	944	4,646
1978	12,667	1,018	4,260
1979	11,777	834	4,172
1980	9,926	788	3,662
1981	8,698	697	3,121
1982	7,324	580	2,508
1983	6,691	542	2,467
1984	6,798	610	2,723
1985	6,497	537	2,508
1986	5,965	578	2,328
1987	5,891	598	2,313
1988	6,027	652	2,417
1989	5,980	757	2,683
1990	5,237	648	2,254
1991	4,864	565	1,923
1992	4,478	536	1,830
1993	4,480	584	1,744
1994	4,523	572	1,829
1995	4,168	524	1,754
1996	3,799	449	1,486
1997	3,416	419	1,370
1998	3,097	385	1,179
1999	3,110	363	1,264
2000	3,113	369	1,079
2001	2,843	386	1,038
2002	2,713	316	866
2003	2,606	300	921
2004	2,663	333	957
2005	2,643	329	921
2006	2,517	325	933
2007	2,354	299	881
2008	2,081	266	907
2009	1,644	226	644
2010	1,771	226	782
2011	1,789	211	885
2012	1,700	199	819
2013	1,781	207	848
2014	1,969	235	736
2015	1,783	208	944
2016	1,739	227	727
2017	1,833	241	734

Source: Federal Railroad Administration Safety Data website (safetydata.fra.dot.gov/officeofsafety).

Table A-6. Collisions at Public Crossings Involving Motor Vehicles by Type of Train, 2004.

Type of train	Collisions
Freight	1,199
Passenger/commuter	179
Yard switching	84
Other*	155
Total	1,617

* Note: "Other" includes work trains, light locomotives, single car, short group of cars being switched, maintenance/inspection car, and special maintenance-of-way equipment.

Source: Unpublished data from Federal Railroad Administration.

Crossing Improvement Funding Programs

The first authorization of federal funds for highway construction occurred in 1912 when Congress allocated \$500,000 for an experimental rural post road program. The Federal-Aid Road Act of 1916 provided federal funds to the States for the construction of rural post roads. These funds could be expended for safety improvements at highway-rail grade crossings, as well as for other highway construction. The States had to match the federal funds on a 50-50 basis and often required railroads to pay the State's 50 percent share or more.

Since then, the program has gone through various revisions. The remainder of this section will focus on how the current program has been more recently shaped. The Surface Transportation Assistance Act (STAA) of 1987 established Section 130 of Chapter 23 of the United States Code, giving the Federal-Aid Rail-Highway Grade Crossing Safety Program permanent status under the law for the first time.⁽⁷⁹⁾

In 1991, Congress passed the Intermodal Surface Transportation Efficiency Act (ISTEA). This act established the National Highway System (NHS) and Surface Transportation Program (STP). The NHS consists of the interstate system and other highways of national significance, plus certain intermodal connections; the STP covers all other public roads and streets.

Section 1007(d)(1) of ISTEA required that 10 percent of each State's STP funds be set aside for safety improvements under Sections 130 and 152 (Hazard Elimination) of Title 23. It further required that the State reserve in each fiscal year an amount not less than the amount apportioned in each program for fiscal year 1991. If the total set aside was more than the 1991 total for these programs, the surplus was to be used for safety, but may be used for either program; if the total is less than the total 1991 apportionment, the safety set-aside funds were to be used proportionately for each program. ISTEA, therefore, provided for the continuation of categorical safety programs.⁽⁸⁰⁾

The ISTEA removed the potential to fund railroad grade separations at 100 percent, or G-funded projects as referred to at that time. It also reduced the percentage of a State's federal funds that could be used for G-funded work from 25 percent, which had been in effect for many years, to 10 percent.

Section 1021(c) of ISTEA permitted an increased federal share on certain types of safety projects, including traffic control signalization; pavement marking; commuter carpooling and vanpooling; or installation of traffic signs, traffic lights, guardrails, impact attenuators, concrete barrier end treatments, breakaway utility poles, or priority control systems for emergency vehicles at signalized intersections. FHWA determined that railroad grade crossing signals are included in the category “traffic control signalization.”

In 1995, Congress passed the NHS Designation Act, which included a provision that made any activities associated with the closure of a highway-railroad grade crossing eligible for 100 percent federal funding. This increased federal share was discontinued with the subsequent passage of Safe, Accountable, Flexible, Efficient Transportation Equity Act—A Legacy for Users (SAFETEA-LU).

Congress enacted the Transportation Equity Act for the 21st Century (TEA-21) in 1997. This act extended the funding arrangements (safety set-asides and other provisions) that had been established in ISTEA and the NHS Designation Act.

In the summer of 2005, Congress passed the SAFETEA-LU, which was signed into law by the President on August 10, 2005. The SAFETEA-LU requires that each State develop a Strategic Highway Safety Plan (SHSP), which addresses engineering, management, education, enforcement, and emergency service elements of highway safety as key factors in evaluating highway safety projects. Highway-rail grade crossing safety may be considered part of the SHSP.

The SAFETEA-LU created the Highway Safety Improvement Program (HSIP), elevating it to a new core federal-aid funding program beginning in fiscal year 2006, with the aim of achieving a significant reduction in traffic fatalities and serious injuries on all public roads. This new program replaced the 10 percent safety set-aside program element of the STP established under ISTEA. It also restored categorical funding for each of the highway safety construction programs. SAFETEA-LU continued the Section 130 program as a set-aside under the new HSIP and established that the federal share payable on any Section 130-funded project shall be 90 percent. A total of \$220 million in highway-railroad crossing safety funds was apportioned among the States for fiscal years 2006 through 2009. Half of these funds were apportioned among the States according to the formula for apportionment of STP funding; the other half were apportioned according to the number of public highway-rail crossings in each State. To aid in the implementation of the new program, FHWA published fact sheets on the new HSIP and the Rail-Highway Crossing provisions.⁽⁸⁰⁾

The SAFETEA-LU continued the requirement that a State spend a minimum of 50 percent of its apportionment for the installation of protective devices at railway-highway crossings. The remaining funds could be spent for other types of improvements as defined in Section 130, including for installation of protective devices at railway-highway crossings. At a minimum, each State was to receive of one-half percent of the total program funding. The SAFETEA-LU also contained a provision to use up to 2 percent of the funds apportioned to a State for compilation and analysis of data for the required annual report to the Secretary on the progress being made to implement the railway-highway crossings program. It also contained a Special Rule under 23 U.S.C. 130(e) that if a State could demonstrate to the satisfaction of the Secretary

it had met all of its needs for installation of protective devices at railway-highway crossings, funds could be used for other highway safety improvement purposes.⁽⁸¹⁾

The program further required each State to conduct and systematically maintain a survey of all highways to identify those railroad crossings that may require separation, relocation, or protective devices, and established a schedule of projects for this purpose. At a minimum, this schedule was to provide signs for all railway-highway crossings (23 U.S.C. 130(d)).⁽⁸¹⁾ Through the HSIP planning process, each State was required to incorporate analyzing safety data to develop a Rail-Highway Crossings Program that (A) considered the relative risk of rail crossings based on a hazard index formula; (B) includes on-site inspection; and (C) resulted in a program of safety improvement projects with special emphasis on providing standard signing and marking at all rail crossings (23 CFR 924.9(a)(4)(ii)).⁽⁸²⁾

After several continuing resolutions extended SAFETEA-LU, the Moving Ahead for Progress in the 21st Century (MAP-21) Act passed in July 2012 continuing funding of the Section 130 Railway-Highway Crossings Program at \$220 million per year through 2014 with minimal changes.

The Fixing America's Surface Transportation (FAST) Act, passed in late 2015, authorized \$225 million starting in fiscal year 2016 and increasing by an additional \$5 million each year through fiscal year 2020.⁽⁸³⁾ In addition, the 2016 Department of Transportation (DOT) Appropriations Act raised the Section 130 set-aside for fiscal year 2016 to \$350 million. The FAST Act also continues all prior program eligibilities in addition to extending eligibility to include the relocation of highways to eliminate railway-highway grade crossings and projects at crossings to eliminate hazards posed by blocked crossings due to idling trains. Apart from the new authorized amounts and eligibility described herein, the FAST Act makes no changes to the Section 130 Railway-Highway Crossings Program.

Additional information can be found online at <https://www.fhwa.dot.gov/fastact/>.

In summary, there are three sources of federal funding for construction of highway-rail grade crossing safety improvements:

- The State's normal federal-aid highway funding may be used. This may include Bridge Replacement, NHS, or STP funding
- Section 130 set-aside funds may be used
- Funding from other safety programs, such as other HSIP funds, may be used if such use is consistent with the State's SHSP and the project meets HSIP program eligibility requirements

Activities eligible for the use of Section 130 safety funds are as follows:

- Crossing consolidations (including the funding of incentive payments up to \$7,500 to local jurisdictions for crossing closures if matched by the railroad)
- Projects that eliminate hazards at railway-highway crossings
- Separation or protection of grades at crossings
- Reconstruction of existing railroad grade crossing structures

- Relocation of highways to eliminate grade crossings
- Projects at grade crossings to eliminate hazards posed by blocked grade crossings due to idling trains
- Signage at crossings
- Pavement marking at crossings
- Illumination at crossings
- Signals at crossings, including interconnection and preemption
- Improved crossing surfaces
- Sight distance or geometric improvements at crossings
- Data analysis in support of annual reporting requirements (up to 2 percent of apportionment)

The purpose of Section 130 funds is for the elimination of hazards at railway-highway crossings and therefore are not eligible for new crossings or quiet zones to address noise abatement.

Many States have been active in crossing improvement programs for decades. States have been responsible for initiating and implementing projects under the various federal programs. In the past, States have required the railroad or the local government to provide the funds needed to match the federal contribution. States may utilize State funds for crossing improvements and to provide the 10 percent match requirement. In addition to financing costs directly associated with the improvement of highway-rail grade crossings, all States contribute incidentally to crossing components. In general, for crossings located on the State highway system, States provide for the construction and maintenance of the roadway approaches and for signs, markings, and other traffic control devices not located on the railroad right of way. Typically, these include advance warning signs and pavement markings.

Local governments have contributed to highway-rail grade crossing safety improvements by providing the matching funds for improvement projects constructed under Section 130 programs. Localities have also contributed for decades through the construction and maintenance of street approaches to crossings and the signs and pavement markings in advance of the crossings. Some cities and counties conduct traffic engineering and safety studies at specific crossing locations.

Although public agencies have established funding programs for crossing elimination and improvements, the railroads have continued to contribute as well. In some cases, the railroad may pay all, or a part of, the required matching share of a project, or the railroad may contribute “in-kind” by way of supplying materials, providing for flagging services, or constructing or signing a detour route during construction of an improvement. Railroads may also contribute through their track and crossing surface maintenance programs or through vegetation or right-of-way (ROW) clearance programs to improve sight distances at crossings. Some railroads make direct cash contributions to local jurisdictions for crossing consolidations or closures.

RESPONSIBILITIES

Fundamental Issues of Highway-Rail Crossings

An issue as old as the grade crossing safety problem is the question of who should provide and pay for traffic control devices at highway-rail grade crossings.

During the years between 1850 and 1890, tremendous growth in population followed the railroads west. Consequently, there was a need for new highways and streets, practically all of which crossed the railroads at grade. In most cases, the responsibility for these crossings automatically fell upon the railroads. There were occasional collisions at crossings, but they usually were not as serious as those occurring today.

One early collision, involving a train and a wagon in Lima, Indiana, resulted in a suit that eventually reached the U.S. Supreme Court in 1877. In *Continental Improvement Co. v. Stead*, the Supreme Court had to decide who was responsible for the damages incurred. In its decision, the Supreme Court said that the duties, rights, and obligations of a railroad company and a traveler on the highway at the public crossing were “mutual and reciprocal.” It also said that the train had the right of way at over crossings because of its “character,” “momentum,” and the “requirements of public travel by means thereof.” The railroad, however, was bound to give reasonable and timely warning of the train’s approach.

The Supreme Court further stated that “those who are crossing a railroad track are bound to exercise ordinary care and diligence to ascertain whether a train is approaching.” This Supreme Court decision indicated that there was a responsibility upon railroads to warn travelers on highways of approaching trains and a responsibility upon travelers to look, listen, and stop for approaching trains.

This expanded federal highway construction program had a great deal of influence on the Supreme Court’s landmark decision in *Nashville, C. & St. L. Ry. v. Walters* in 1935. Justice Brandeis, writing for the majority of the Court, said:

The railroad has ceased to be the prime instrument of danger and the main cause of accidents. It is the railroad which now requires protection from dangers incident to motor transportation.

Government Agency Responsibility and Involvement

Today, because a highway-rail crossing involves the intersection of two transportation modes—one public and the other private—safe and efficient operation requires strict cooperation and coordination of the involved agencies and organizations.

At the federal level, six agencies within the United States Department of Transportation (USDOT) and two agencies outside USDOT have specific safety-related roles with respect to highway-rail grade crossings:

- Federal Highway Administration (FHWA)
- Federal Railroad Administration (FRA)
- National Highway Traffic Safety Administration (NHTSA)
- Federal Motor Carrier Safety Administration (FMCSA)
- Federal Transit Administration (FTA)
- Pipeline and Hazardous Materials Safety Administration (PHMSA)
- National Transportation Safety Board (NTSB)
- Surface Transportation Board (STB)

At the State level, program administration and responsibility include the following:

- State highway departments
- State departments of transportation
- State regulatory agencies (usually called public service commissions or public utility commissions)
- State highway safety agencies
- State departments of public safety (State police or highway patrol)

At the local level, public agencies involved include the following:

- State highway department field maintenance organizations
- County or township road departments
- City street departments or public works agencies
- County or local law enforcement agencies

Each of these involvements is described below.

FHWA

The FHWA provides oversight for the State administered federally-funded programs, several of which are available for crossing improvements. FHWA apportions funds to the States according to a legislated formula and in the amounts authorized by Congress for each program. It establishes procedures by which the States obligate the funds to specific projects and oversees the overall implementation of the federally-funded programs.

The FHWA establishes standards for traffic control devices and systems at crossings and publishes them in the *Manual on Uniform Traffic Control Devices* (MUTCD).⁽¹⁾ FHWA also has adopted various design criteria and guidelines developed by the American Association of State Highway and Transportation Officials (AASHTO) and other organizations for use on federal-aid construction and reconstruction projects. It approves State-developed design directives and

design criteria for resurfacing, restoration, and rehabilitation projects and other activities. The FHWA provides technical assistance to States and local agencies through the distribution of state-of-the-art publications, training classes, and the activities of State Local Technical Assistance Program centers.

The FHWA conducts research to support the previously listed activities, and research conducted by the States is often funded using Federal-Aid State Planning and Research funds. Typical research topics include traffic control devices, roadside safety, collision causation, program management tools, and collision countermeasures. Any FHWA crossing research is coordinated with FRA. FHWA promotes the maintenance of individual State grade crossing inventories and the updating of the national inventory database.

FRA

The FRA maintains the national Railroad Accident/Incident Reporting System that contains information reported by the railroads on crossing collisions. The FRA also serves as custodian of the National Highway-Rail Crossing Inventory that contains the physical and operating characteristics of each crossing. The information in the Crossing Inventory is submitted and updated by the railroads and the States. The FRA prepares, publishes, and distributes reports summarizing collision and crossing data and makes the data available on the Internet.

The FRA generally conducts field investigations of railroad accidents/incidents, including crossing collisions, which result in the death of a railroad employee or the injury of five or more persons. FRA also investigates complaints by the public pertaining to crossings and makes recommendations to the industry as appropriate.

The FRA conducts research to identify solutions to crossing problems, primarily from a railroad perspective. Typical research involves program management tools, train-borne warning devices, train car and locomotive reflectorization, and track circuitry improvements. Research is coordinated with FHWA. Both FHWA and FRA have field offices located throughout the United States that collaborate with State agencies and individual railroads on program and project issues. They ensure that policies and regulations are effectively implemented and provide feedback to headquarters regarding needs identified at the field level.

The FRA also sponsors a considerable amount of research into railroad and crossing safety issues. A significant portion of this research is carried out by the John A. Volpe National Transportation Systems Center in Cambridge, Massachusetts. Other research is performed through the National Cooperative Highway Research Program (NCHRP), administered by the Transportation Research Board.

The FRA regulations enhance highway-rail crossing safety by requiring railroads to:

- Report any impact between a highway user and railroad on-track equipment at a highway-rail grade crossing
- Equip locomotives with auxiliary lights to improve the conspicuity of approaching trains

- Place retro-reflective material on railroad rolling stock to make them more visible during the night or reduced light situations
- Periodically maintain, inspect and test automatic warning devices
- Sound locomotive horns when approaching public highway-rail crossings, unless the crossing is located within a quiet zone
- Have an Emergency Notification System by which the public may report unsafe conditions at crossings to the railroad
- Submit accurate, up-to-date railroad-related crossing information to the National Highway-Rail Crossing Inventory

NHTSA

The NHTSA maintains the Fatal Accident Reporting System (FARS), a database containing information on all fatal highway collisions. The NHTSA coordinates with FRA and FHWA to provide information in FARS pertinent to crossings. The NHTSA also funds educational programs and selective law enforcement programs at crossings through State highway safety offices.

FMCSA

The FMCSA was established as a separate administration within USDOT on January 1, 2000, pursuant to the Motor Carrier Safety Improvement Act of 1999. The primary mission of FMCSA is to reduce crashes, injuries, and fatalities involving large trucks and buses. The FMCSA is committed to increasing grade crossing safety messages to the freight and passenger motor carrier industry, as well as to its safety oversight and enforcement partners. The FMCSA encourages States to use their Motor Carrier Safety Assistance Program (MCSAP) contacts to distribute grade crossing safety materials focused on motor carrier needs and issues at crossings. The FMCSA also develops informational packages for firms in the motor carrier industry.

FTA

The FTA is one of 10 modal administrations within USDOT. It provides financial and technical assistance to local public transit systems including buses, subways, light rail, commuter rail, monorail, trolleys and ferries. FTA maintains the Safety Management System which compiles and analyzes transit safety and security data. FTA also maintains the National Transit Database (NTD) which provides a repository of data about the financial, operating and asset conditions of transit systems.

PHMSA

The PHMSA is a separate operating administration for pipeline safety and hazardous materials transportation safety operations. The PHMSA is the federal agency charged with the safe and secure movement of almost one million daily shipments of hazardous materials by all modes of transportation, including by rail. The agency also oversees the U.S. pipeline infrastructure, which accounts for 64 percent of the energy commodities consumed in the United States. The agency establishes national policy, sets and enforces standards, educates, and conducts research

to prevent incidents. The PHMSA also prepares the public and first responders to reduce consequences if an incident does occur.

NTSB

The NTSB provides a comprehensive review of the safety aspects of all transportation systems. Through special analyses and collision investigations, it identifies specific safety problems and recommends associated remedies that are presented as recommendations to specific agencies and organizations.⁽⁸⁴⁾

STB

The STB was created as an economic regulatory agency with the ICC Termination Act of 1995 and is the successor agency to ICC. The STB serves as both an adjudicatory and a regulatory body. The agency has jurisdiction over railroad rate and service issues and rail restructuring transactions including mergers, line sales, line construction, and line abandonments.

State and Local Level

Jurisdiction over highway-rail grade crossings resides primarily with the States. State highway and transportation agencies are responsible for the implementation of a program that is broad enough to involve any public crossing within the State. Within some States, responsibility is assigned to a regulatory agency referred to as a public service commission, a public utilities commission, or similar designation. In other States, the authority is divided among the public administrative agencies of the State, county, or city having jurisdiction over the respective highway and street systems—practitioners are advised to verify current local responsibilities. State and local law enforcement agencies are responsible for the enforcement of traffic laws at crossings. Local government bodies are responsible for ordinances governing traffic laws and operational matters relating to crossings. States have State-specific laws that can affect how their programs (including funding and maintenance) are managed.

The historical shifting of responsibility for safety at crossings from the railroads to the public and the increasing availability of federal funds have led to more of that responsibility being placed on State and local agencies. This shift culminated with the inclusion of Part VIII, “Traffic Control Systems for Highway-Rail Grade Crossings,” in the 1978 edition of MUTCD. Part VIII consolidated certain information that had been scattered throughout MUTCD and superseded the Association of American Railroads (AAR) bulletins covering crossing signalization that had been issued by AAR Committee D. The FHWA has also issued regulations specifying criteria for the selection of traffic control devices at highway-rail grade crossings.

The highway agency having jurisdiction at public crossings is the entity responsible for determining appropriate traffic control devices. Even though the railroads retain the responsibility for the installation and maintenance of Crossbuck signs at passive crossings and for the design, construction, operation, and maintenance of railroad crossing signals, State transportation and regulatory agencies have the responsibility to assure that the standards set forth in MUTCD and elsewhere in federal regulations are followed. The street or highway agency is also responsible for the installation and maintenance of all traffic control devices on the

approaches to the crossing; for the design, construction, operation, and maintenance of highway traffic signals that may be interconnected with the grade crossing signals; and for the installation and maintenance of certain passive signs at the crossing, such as STOP signs or “Do Not Stop on Tracks” signs.

Although the railroads retain responsibility for the construction, reconstruction, and maintenance of the track structure and the riding surface at the highway-rail intersection, their obligation for the roadway usually ends within a few inches of the outside ends of the ties that support the rails and the crossing surface. The street or highway agency has responsibility for the design, construction, and maintenance of the roadway approaches to the crossing, even though these approaches may lie within the railroad’s ROW.⁽⁸⁵⁾

Railroad Responsibility and Involvement

Railroads work with State, county, and municipalities to alleviate operational and safety concerns at highway-rail grade crossings. Typically, Class I carriers have “public projects” staff who work with State and local highway authorities to implement improvements to grade crossings, grade crossing closures, grade separations, and quiet zone improvements. Railroads also conduct some research to identify and apply new technology and further new concepts regarding crossing safety and operations.

Founded in 1934, the AAR leads a wide range of policy, research, standards setting, and technology related to the operations of the U.S. freight rail industry. The AAR full members include the major freight railroads in the United States, Canada and Mexico, as well as Amtrak. The AAR railroad affiliate and associate members include non-Class I and commuter railroads, rail supply companies, engineering firms, signal and communications firms, and rail car owners.

Policy Making

Working with elected officials and leaders in Washington, DC, AAR works to advance sound public policy that supports the interests of the freight rail industry to ensure it will continue to meet America’s transportation needs.

Standard Setting

As the standard setting organization for North America’s railroads, AAR establishes safety, security, and operating standards that provide for seamless and safe operations across America’s 140,000-mile freight rail network.

Industry Data, Reports and Publications

The AAR prepares weekly, quarterly, and annual statistical reports providing comprehensive insight into the operations of North America’s freight railroads. The AAR members may access the publications catalog, covering many aspects of freight railroading from the latest economic statistics to the correct means of loading and securing various freight shipments and research reports from AAR’s Transportation Technology Center, Inc. (TTCI). These publications offer economic, financial, policy, and general statistical information, and can be purchased from their online catalog.

Research and Technology Initiatives

Through its two subsidiaries, TTCI and Railinc, AAR supports continued research and development projects to enhance the safety, security, and efficiency of the railroad industry. The TTCI is the world's leading research, development, and testing facility, and develops next-generation advancements in safety and operational efficiency. Railinc serves as the rail industry's leading resource for rail data, information technology, and information services, and uses one of the world's largest data networks to track customer shipments. The AAR also supports the Railroad Research Foundation, a world-class policy research organization dedicated to sustaining a safe, secure, and technologically advanced rail network.

The AAR has been active in crossing programs and has established a State-Rail Programs Division within its Operations and Maintenance Department. This division provides information to Congress and USDOT to assist in the administration and establishment of crossing programs. Railroad interests and concerns regarding crossing programs are typically coordinated through the AAR office. The State-Rail Programs Division has an appointed railroad employee in each State to serve as the AAR State representative on crossing safety matters. A list of State representatives is available from AAR.

Other railroad-related companies and suppliers also participate in crossing safety programs. The signal suppliers and manufacturers of crossing surface systems provide guidance for the selection of a specific device or crossing surface. In addition, these companies are actively conducting research to improve their products.

B. APPENDIX—COMPONENTS OF A HIGHWAY-RAIL GRADE CROSSING

A highway-rail grade crossing can be viewed as simply a special type of highway intersection, in that the three basic elements of any intersection are present: the driver, the vehicles, and the physical intersection. As with a highway intersection, drivers must appropriately yield the ROW to opposing traffic; unlike a highway-highway intersection, the opposing traffic—the train—is not required to yield the ROW to the highway vehicle. Drivers of motor vehicles have the flexibility of altering their path of travel and can alter their speed within a short distance. Train operators, on the other hand, are restricted to moving their trains down a fixed path, and changes in speed can be accomplished much more slowly. Because of this, motorists bear most of the responsibility for avoiding collisions with trains.

The railroad Crossbuck sign is defined in the MUTCD as a regulatory sign. In effect, it is a YIELD sign, and motorists have the obligation to so interpret it. Traffic and highway engineers can assist motorists with the driving task by providing them with proper highway design, adequate sight distances, and proper traffic control devices.

The components of a highway-rail grade crossing are divided into two categories: the highway and the railroad. The highway component can be further classified into several elements including the roadway, drivers, pedestrians and bicyclists, and vehicles. The railroad component is classified into train and track elements. The location where these two components meet should be designed to incorporate the basic needs of both highway vehicles and trains.

Traffic control devices are utilized to provide road users with information concerning the crossing. Typically, an advance warning sign and pavement markings inform the motorist that a crossing lies ahead in the travel path. The crossing itself is identified and located using the Crossbuck. These traffic control devices—the advance sign, pavement markings, and Crossbuck—are termed “passive” because their message remains constant with time.

“Active” traffic control devices tell the motorist if a train is approaching or occupying a crossing and, thus, give a variable message. Typical active traffic control devices are flashers or flashers and automatic gates. A highway traffic signal may also be interconnected to the crossing signals and would form part of the traffic control system at the crossing.

The USDOT National Highway-Rail Crossing Inventory provides information on the number of crossings having each type of traffic control device, as shown in **Table B-1**.

HIGHWAY COMPONENTS

Driver

The driver is responsible for obeying traffic control devices, traffic laws, and the rules of the road. Highway and railroad engineers who plan and design initial installations or later improvements to traffic control systems at railroad grade crossings should be aware of the several capabilities, requirements, needs, and obligations of the driver. This information will help them, through the proper engineering design of improvements, assisting drivers in meeting their responsibilities.

Table B-1. Public Crossings by Warning Device, 2017

Warning device	Number	Percent
Active devices		
Gates	50,018	39.16
Flashing lights	17,613	13.79
Highway signals, wigwags, or bells	1,326	1.04
Special ^a	908	0.71
Total active	69,865	54.69
Passive devices		
Crossbucks	43,289	33.89
STOP signs	11,877	9.30
Other signs	265	0.21
Total passive	55,431	43.39
No signs or signals	2,442	1.91
Total	127,738	100.00

^a Note: “Special” are traffic control systems that are not train activated, such as a crossing being flagged by a member of the train crew.

Source: Federal Railroad Administration.¹

This section deals with the duties of the motor vehicle driver.

As of 2000, the Uniform Vehicle Code (UVC) is a specimen set of motor vehicle laws designed or advanced as a comprehensive guide or standard for State motor vehicle and traffic laws.⁽⁸⁶⁾ It describes the actions a driver is required to take at highway-rail grade crossings. The UVC defines the “appropriate actions” vehicle operators are required to take for three situations: vehicle speed approaching the crossing; vehicle speed traversing the crossing; and stopping requirements at the crossing. The provisions in UVC for these actions are set out below:

- Approach Speed (Sec. 11-801).

No person shall drive a vehicle at a speed greater than is reasonable and prudent under the conditions and having regard to the actual and potential hazards then existing. Consistent with the foregoing, every person shall drive at a safe and appropriate speed when approaching and crossing an intersection and railroad grade crossing....

- Passing (Sec. 11-306).

(a) No vehicle shall be driven on the left side of the roadway under the following conditions...

...2. When approaching within 100 feet of or traversing any intersection or railroad grade crossings unless otherwise indicated by official traffic control devices...

¹ (Updated data can be found on the FRA’s Office of Safety Analysis website [also known as Safetydata] at <https://safetydata.fra.dot.gov>)

- Vehicles Approaching a Highway-Rail Grade Crossing (Sec. 11-701)

(a) Whenever any person driving a vehicle approaches a railroad grade crossing under any of the circumstances stated in this section, the driver of such vehicle shall stop within 50 feet but not less than 15 feet from the nearest rail of such railroad, and shall not proceed until it is safe to do so. The foregoing requirements shall apply when:

- 1. A clearly visible electric or mechanical signal device gives warning of the immediate approach of a railroad train;*
- 2. A crossing gate is lowered or when a human flagger gives or continues to give a signal of the approach or passage of a railroad train;*
- 3. A railroad train approaching within approximately 1,500 feet of the highway crossing emits a signal audible from such distance, or such railroad train by reason of its speed or nearness to such crossing is an immediate hazard;*
- 4. An approaching railroad train is plainly visible and is in hazardous proximity to such crossing.*

(b) No person shall drive any vehicle through, around or under any crossing gate or barrier at a railroad crossing while such gate or barrier is closed or is being opened or closed.

- Designated Vehicles Must Stop at Highway-Rail Grade Crossings (11-702)

(a) Except as provided in subsection (b), the driver of any vehicle described in regulations issued pursuant to subsection (c), before crossing at grade any track or tracks of a railroad, shall stop such vehicle before the stop line (if present) and not less than 15 feet from the nearest rail of such track, and while so stopped shall listen and look in both directions along such track for any approaching train and for signals indicating the approach of a train and shall not proceed until it is safe to do so. After stopping as required, upon proceeding when it is safe to do so, the driver shall cross only in a gear of the vehicle that will not require manually changing gears while traversing such crossing and the driver shall not manually shift gears while crossing the track or tracks.

(b) This section shall not apply at:

- 1. Any railroad grade crossing at which traffic is controlled by a police officer or flagger;*
- 2. Any railroad grade crossing at which traffic is regulated by a traffic-control signal;*
- 3. Any railroad grade crossing protected by crossing gates or an alternately flashing light signal intended to give warning of the approach of a railroad train;*
- 4. Any railroad grade crossing at which an official traffic control device gives notice that the stopping requirement imposed by this section does not apply.*

(c) The (commissioner or other appropriate State official or agency) shall adopt regulations, as may be necessary, describing the vehicles that must comply with the stopping requirements of this section. In formulating those regulations, the (commissioner or other appropriate State

official or agency) shall give consideration to the number of passengers carried by the vehicle and the hazardous nature of any substance carried by the vehicle in determining whether such vehicle shall be required to stop. Such regulations shall correlate with, and so far as possible, conform to the most recent regulation of the United States Department of Transportation.

Each State has its own traffic laws, which may vary from those above. The pertinent sections of the State code and the State driver licensing handbook should be consulted for more information.

Vehicle

The design and operation of a railroad grade crossing should reflect the number and types of vehicles that can be expected to use it. In this regard, crossings are exposed to the full array of vehicle types found on highways, from motorcycles to truck tractor/triple-trailer combinations, although the use of crossings by the largest vehicle types is rare. Typically, the largest vehicles that will use an at-grade crossing are full-size passenger buses or design trucks such as WB-50. The vehicles utilizing highway-rail grade crossings have widely different characteristics that will directly influence the design elements of the crossing. Equally important is the cargo these vehicles carry, especially children in school buses and hazardous materials in trucks.

Table B-2 summarizes collisions at crossings by vehicle type. Rates are defined as collisions per billion miles of travel. The data provides some indication of the relative hazards for each of the vehicles. Trucks have the highest collision rates of all vehicle types. Motorcycles have a higher fatality rate, probably because of the lack of operator protection provided by the vehicle.

Several physical and performance characteristics influence the safety of vehicles at crossings. These include vehicle dimensions, braking performance, and acceleration performance.

Vehicle Dimensions

The length of a vehicle has a direct bearing on the inherent safety of the vehicle at a grade crossing and, consequently, is an explicit factor considered in the provision of sight distances. Long vehicles and vehicles carrying heavy loads have longer braking distances and slower acceleration capabilities; hence, long vehicles may be exposed to a crossing for an even greater length of time than would be expected in proportion to their length.

Vehicle length is explicitly considered in determining the effect of sight distance, and the corner sight triangle on the safe vehicle approach speed toward the crossing and in determining the sight distance along the track for vehicles stopped at the crossing. The design lengths of various vehicles are specified by the AASHTO and shown in **Table B-3**.

Table B-2. Motor Vehicle Collisions and Casualties at Public Crossings by Vehicle Type, 2017

—	Automobiles ^a	Buses	Trucks ^b	Motorcycles	Total
Total collisions					
Number	1,828	7	587	9	2,431
Rate ^c	0.67	1.05	2.59	0.90	0.84
Percent	75.19	0.29	24.15	0.37	100.00
Total fatalities					
Number	204	0	35	2	241
Rate ^c	0.08	0.00	0.15	0.20	0.08
Percent	84.65	0.00	14.52	0.83	100.00
Total injuries					
Number	648	7	225	5	885
Rate ^c	0.24	1.05	0.99	0.50	0.31
Percent	73.22	0.79	25.42	0.57	100.00
Vehicle miles of travel (billions)	2,719.32	6.64	226.51	10.05	2,890.89
Registered vehicles	228,276,000	795,000	8,171,000	5,781,000	236,761,000
Collisions per million vehicles	8.01	8.81	71.84	1.56	10.27

^a “Automobiles” includes passenger cars, pick-up trucks, vans, and sport utility vehicles.

^b “Trucks” includes both single-unit trucks and combination trucks.

^c “Rate” is the number of collisions, fatalities, or injuries divided by billions of vehicle miles traveled.

Source: FRA and FHWA.

Table B-3. U.S. Customary Lengths for Design Vehicles

Design vehicle type	Designation	Length (feet)
Passenger car	P	19
Single-unit truck	SU	30
Buses		
Intercity bus (motor coaches)	BUS-40	40
	BUS-45	45
City transit bus	CITY-BUS	40
Conventional school bus (65 passengers)	S-BUS 36	35.8
Large school bus (84 passengers)	S-BUS 40	40
Articulated bus	A-BUS	60
Trucks		
Intermediate semitrailer	WB-40	45.5
Intermediate semitrailer	WB-50	55
Interstate semitrailer	WB-62*	68.5
Interstate semitrailer	WB-65** or WB-67	73.5
“Double-bottom” semitrailer/trailer	WB-67D	73.3
Triple-semitrailer/trailers	WB-100T	104.8
Turnpike double-semitrailer/trailer	WB-109D*	114
Recreational Vehicles		
Motor home	MH	30
Car and camper trailer	P/T	48.7
Car and boat trailer	P/B	42
Motor home and boat trailer	MH/B	53

*Design vehicle with 48-foot trailer as adopted in the 1982 Surface Transportation Assistance Act.

**Design vehicle with 53-foot trailer as adopted grandfathered in with the 1982 Surface Transportation Assistance Act.

Source: From *A Policy on Geometric Design of Highway and Streets, 2011*, by the American Association of State Highway and Transportation Officials, Washington, DC. Used by permission.

The AASHTO recognizes 20 design vehicle classes. This reflects the increase in the size of tractor-semitrailers, which began with the passage of the Surface Transportation Assistance Act of 1982, as well as the increasing presence of articulated buses in the U.S. transit fleet and the increasing popularity of recreational vehicles and motor homes.⁽⁸⁷⁾

Unless trucks are prohibited at the crossing, it is desirable that the design vehicle be at least a tractor-semitrailer truck (WB-15 SI Metric, or WB-50). Typically, the design vehicle should be a “double-bottom” vehicle (WB-18 SI Metric, or WB-60) for those crossings on routes designated for longer trucks, although consideration should be given especially to long vehicles where

applicable. On major arterials with significant truck traffic, the design vehicle should be an “interstate” semitrailer truck (WB-62 or WB-65).

The width of the vehicle may be an issue when selecting the crossing surface. Since the passage of the 1982 STAA, trucks and intercity buses are permitted to have widths of 102 inches, as indicated in Table 2-1b of the AASHTO: *A Policy on Geometric Design of Highways and Streets*.⁽⁸⁷⁾

Braking Performance

One component of stopping sight distance is a function of a vehicle’s braking performance. If a crossing experiences a significant percentage of heavy trucks, any given sight distance will dictate a slower speed of operation to allow for the braking performance of these vehicles.

Acceleration Performance

Acceleration of vehicles is important to enable a stopped vehicle to accelerate and clear the crossing before a train that was just out of sight or just beyond the train detection circuitry reaches the crossing. Large trucks that have poor acceleration capabilities coupled with long lengths are particularly critical in this type of situation.

There are three phases of operation for a truck that has stopped at a crossing: start-up when the clutch is being engaged; acceleration from the point of full clutch engagement; and continued travel until the crossing is cleared.

Another aspect of the acceleration performance of vehicles at crossings is the design of the crossing approaches coupled with the condition of the crossing surface. Crossings and approaches on a steep grade are difficult and time-consuming to cross. Also, vehicles will move more slowly over crossings that have rough surfaces.

Special Vehicles

The following three vehicle types are of particular concern for crossing safety: trucks carrying hazardous materials; any commercial motor vehicle transporting passengers; and school buses. Collisions involving these vehicles can result in numerous injuries and/or fatalities, perhaps in catastrophic proportions if certain hazardous cargoes are involved.

In a special study conducted by the NTSB, it was determined that an average of 62 collisions involving a train and a truck transporting hazardous materials occur annually. NTSB’s examination of the collision data revealed that these collisions tend to occur near truck terminals.⁽⁸⁸⁾

Requirements for commercial vehicles to stop or slow at highway-rail grade crossings are contained in 49 CFR 392.10, which requires that the driver of a specified commercial motor vehicle:

Except as provided in paragraph (b) of this section, the driver of a commercial vehicle specified in paragraphs (a) (1) through (6) of this section shall not cross a railroad track or tracks at grade unless he/she first: Stops the commercial motor vehicle within 50 feet of, and not closer than 15 feet to, the tracks; thereafter listens and looks in each direction along the tracks for an approaching train; and ascertains that no train is approaching. When it is safe to do so, the driver may drive the commercial motor vehicle across the tracks in a gear that permits the

commercial motor vehicle to complete the crossing without a change of gears. The driver must not shift gears while crossing the tracks.

Vehicles to which this rule pertains include but are not limited to the following:

- Every bus transporting passengers and vehicles transporting migrant workers. (“Bus” is defined at 49 CFR 390.5 as “as any motor vehicle designed, constructed, and or used for the transportation of passengers, including taxicabs.”)
- Every commercial motor vehicle which, in accordance with the regulations of USDOT, is required to be marked or placarded with hazardous materials including the following:
 - Poison Gas
 - Flammables
 - Chlorine
 - Poison
 - Oxygen
 - Combustible liquids

As required by 49 CFR 398.4, all such motor vehicles shall display a sign on the rear reading, “This Vehicle Stops at Railroad Crossings.”

Finally, 49 CFR 392.11 provides that:

Every commercial motor vehicle other than those listed in §392.10 shall, upon approaching a railroad grade crossing, be driven at a rate of speed which will permit said commercial motor vehicle to be stopped before reaching the nearest rail of such crossing and shall not be driven upon or over such crossing until due caution has been taken to ascertain that the course is clear

Provisions to enhance safety for these special vehicles are further discussed in Chapter 6, Special Topics.

Pedestrians

In 2017, collisions involving pedestrians at crossings accounted for 8.1 percent, or 172, of all crossing collisions. As might be expected, these collisions almost always result in an injury or fatality. In 2017, there were 86 pedestrian fatalities, comprising 31.7 percent of all crossing fatalities. These statistics do not include pedestrian collisions occurring elsewhere along railroad tracks. Excluding collisions and incidents at crossings, 535 trespasser fatalities occurred on railroad property during 2017. This represents 63 percent of all railroad-related fatalities.

Table B-4 shows the number of highway-rail grade crossing collision fatalities and trespasser fatalities from 2008 to 2017. During this 10-year period, crossing collision fatalities and trespasser fatalities fluctuated. Each year since 2008, the number of trespasser fatalities has been greater than the number of highway-rail grade crossing collision fatalities.

Table B-4. Highway-Rail Grade Crossing Collision Fatalities versus Trespasser Fatalities, 2008–2017

Year	Highway-Rail Grade Crossing Collision Fatalities	Trespasser Fatalities
2008	290	457
2009	248	416
2010	261	441
2011	246	399
2012	231	405
2013	232	427
2014	262	470
2015	236	449
2016	253	465
2017	271	535

Source: Federal Railroad Administration Safety Data website (safetydata.fra.dot.gov/officeofsafety).²

Roadway

A major component of the crossing is the physical configuration of the highway on the approach and at the crossing itself. The following roadway characteristics are relevant to the design and control of highway-rail grade crossings:

- Location—urban or rural
- Type of road—arterial, collector, or local
- Traffic volumes
- Geometric features—number of lanes, horizontal and vertical alignment, sight distance, crossing angle, etc.
- Crossing surface and elevation
- Nearby intersecting highways
- Illumination

Urban crossings often carry more vehicular traffic than rural crossings and have sight restrictions due to developed areas. Urban crossings also involve obstructions to continuous traffic flow, such as controlled intersections, driveways, business establishments and distracting signs, significant lane interaction, and on-street parking.

² Updated data can be found on the FRA's Office of Safety Analysis website (also known as Safetydata) at <https://safetydata.fra.dot.gov>.

All other factors being the same, for a given train volume, collision frequency increases with increasing traffic volume. However, traffic volume alone is not a sufficient forecaster of collisions at crossings.

The geometric features that can affect traffic operations at highway-rail grade crossings include the following:

- Number of lanes and pavement width
- Horizontal and vertical alignment
- Crossing angle
- Crossing elevation

These features, in turn, affect sight distances to and at crossings.

Number of Lanes

Less than 10 percent of all public crossings are on highways with more than two lanes.⁽⁷⁵⁾ It is not known how many crossings with two lanes have an approach width greater than two lanes. The reduction of lanes at a crossing can cause vehicle-vehicle collisions as well as collisions with trains.

At two-lane crossings, a pullout lane may be provided for trucks or buses that may be required to stop for the crossing. By providing a pullout lane, the likelihood of rear-end collisions may be reduced.

Crossings with more than two lanes are usually candidates for cantilevered flashing light signals to improve the visibility of the signals for drivers.

Horizontal Alignment

Sight distance to the crossing is affected by the vertical and horizontal alignment of the crossing and by the crossing angle. Crossings located around a curve or over the crest of a hill may require special attention from the motorist and may need additional signing or active advance warning devices. For new crossings, or major reconstruction, it is desirable to have the crossing angle as close to 90 degrees as possible.

Crossing and Approach Surfaces

The roughness of a crossing surface and the profile of the surface and its approaches may be major areas of concern for road users. A rough surface may contribute to a collision by diverting the road user's attention from the prime tasks of observing the crossing signals and looking for a train.

Crossing Elevation or Profile

Another aspect of the crossing is its elevation. Vehicles that cross the tracks from a stopped position cannot accelerate quickly on steep grades. In addition, trucks with low ground clearances may become trapped on high-profile or "hump-backed" crossings, delaying highway and rail traffic and, possibly, being struck by a train.

Intersecting Highways

Frequently, roads parallel the railroad, and intersecting roads intersect the railroad, resulting in a crossing near the highway intersection. The higher occurrence of collisions at these intersections is due in part to a short storage area for vehicles waiting to move through the crossing and the intersection. If the intersection is signalized or if the approach from the crossing is controlled by a STOP sign, queues may develop across the crossing, leading to the possibility of a vehicle becoming “trapped” on the crossing. Also, there are more distractions to the motorist, leading to the possibility of vehicle-vehicle conflicts.

Crossings within a close distance to a signalized or STOP-controlled intersection should be carefully evaluated for proper controls. STOP controls should be evaluated where either the crossing or the intersection, or both, is not signalized. Traffic signal timing should be carefully evaluated, and an interconnection circuit installed if needed. Joint inspections of interconnected or preempted signals by the railroad and the highway agency should be made on a regular basis to assure that the crossing signals and the highway traffic signal are functioning properly and that the phasing and timing plans are still appropriate.

The critical distance between a highway-rail crossing and a highway-highway intersection is a function of the number of vehicles expected to be queued up by the intersection traffic control.

For additional information, refer to MUTCD Section 4D.27 Preemption and Priority Control of Traffic Control Signals.

Illumination

Illumination of the crossing can definitely aid the motorist. Illumination may be effective in reducing collisions at night; as it will assist road users, including bicyclists and pedestrians, in traversing the crossing at night. USDOT Inventory reports that commercial power is available at more than 90 percent of public crossings. Therefore, lighting is feasible at most crossings; depending, of course, on the reliability of the power source.

Traffic Control Devices

The responsibility for the design, placement, operation, and maintenance of traffic control devices normally rests with the governmental body having jurisdiction over the road or street. For the purpose of installation, operations and maintenance of devices constituting traffic control devices at highway-rail grade crossings, it is recognized that any crossing of a public road with a railroad is situated on a right of way that is available for the use of both highway traffic and railroad traffic on their respective roadway and tracks. This requires joint responsibility in the traffic control function between the public agency and the railroad.

The determination of need and the selection of devices at a grade crossing are normally made by the public agency having jurisdiction. Subject to such determination, the design, installation, and operation of such devices shall be in accordance with the principles and requirements set forth in MUTCD.

Due to the character of operations and the potentially severe consequences of collisions, traffic control devices at highway-rail grade crossings and on the approaches thereto need to be viewed as a system. The combination of approach signs and pavement markings on the roadway approach and the Crossbucks or signals at the crossing provides the road user with multiple notices of the presence of the crossing and the likelihood of encountering a train.

For those sections where rail tracks run within a roadway, which is a common practice for light rail and streetcar operations, traffic control may be provided by a combination of signs, pavement markings, and typical “highway” type control devices such as STOP signs and traffic signals. However, for the broader case, where rail tracks are in a separate ROW with designated crossings of highways and pedestrian pathways, traffic is typically controlled with one of three types of devices, each requiring a distinct compliance response per the UVC, various Model Traffic Ordinances and State regulations:

- A Crossbuck is a type of YIELD sign—The driver should be prepared to stop at least 15 feet before the near rail unless, and until, the driver can make a reasonable decision that there are no trains in hazardous proximity to the crossing and it is safe to cross.
- Operating flashing lights have the same function as a STOP sign—A vehicle is required to stop completely at least 15 feet short of the near rail. Then, even though the flashing lights may still be operating, the driver can proceed after stopping (subject to State or local laws), when safe to do so.
- Flashing lights with lowered gates are equivalent to a red vehicular traffic signal indication—A vehicle is required to stop short of the gate and remain stopped until the gates go up.

Motorist comprehension and compliance with each of these devices is mainly a function of education and enforcement. The traffic engineer should make full use of the various traffic control devices as prescribed in MUTCD to convey a clear, concise, and easily understood message to the driver.

RAILROAD COMPONENTS

Train

Headlights

FRA regulations require that, for locomotives operated through one or more public highway-rail grade crossings at speeds greater than 20 miles per hour, auxiliary lights are to be placed at the front of the locomotive to form a triangle with the headlight.⁽⁸⁹⁾ The inclusion of auxiliary lights helps crossing users determine the distance and approximate speed of an approaching train.⁽⁹⁰⁾

Train Horns

Locomotives are equipped with air-powered horns to sound a warning of a train's approach to a crossing and for various other signals in railroad operations. FRA requires the horn to produce a minimum sound level of 96db(A) and a maximum of 110 db(A) at 100 feet forward of the locomotive. The locomotive engineer sounds the horn in advance of a crossing in a sequence of two long blasts, followed by a short blast, then followed by one long blast. Additional information can be found under Title 49 CFR 222.21 and Title 49 CFR 229.129.^(89, 91)

Reflectorization

FRA regulations governing the reflectorization of rail freight rolling stock (49 CFR Part 224) apply to “railroad freight cars and locomotives that operate over a public or private highway-rail grade crossing and are used for revenue or work train service.”⁽⁹²⁾

These reflectorization regulations require railroads to install yellow or white reflective materials on freight cars and locomotives before placing them in service. **Figure B-1** illustrates the application on a typical freight car.

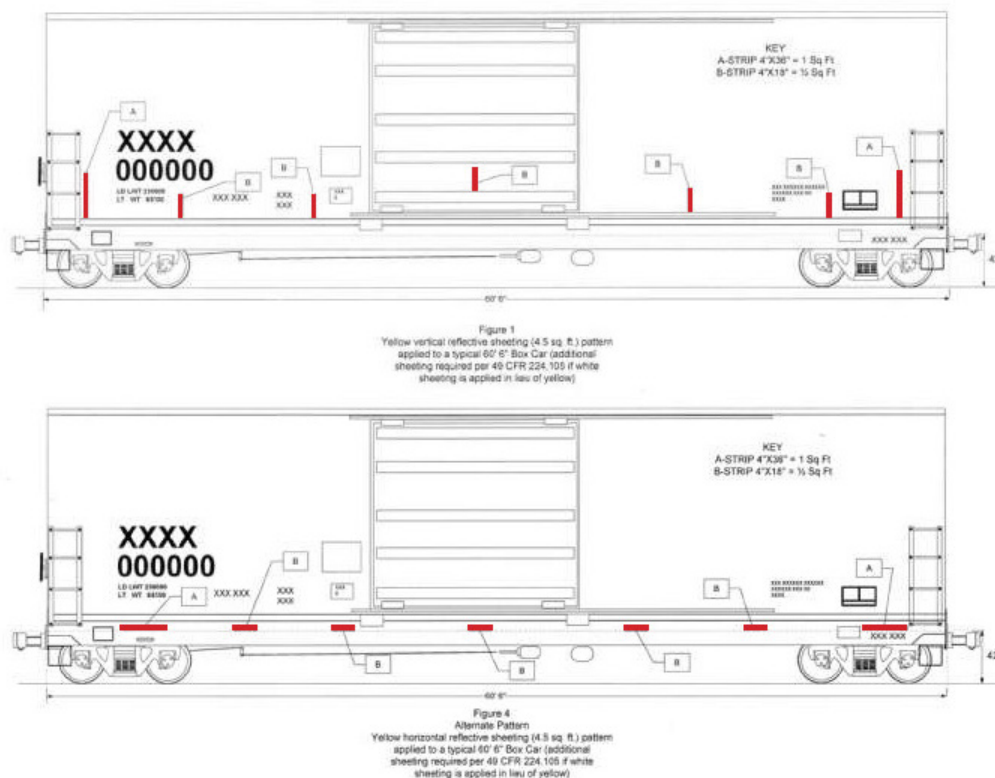

Figure B-1. Reflectorization Example—Standards Applicable to Boxcars

Source: Reflectorization of Rail Freight Rolling Stock final rule, 70 FR 62166 (October 28, 2005).

Braking

Primarily because of their enormous weight, railroad trains are slow to accelerate and decelerate. Numerous factors affect a train's acceleration capability, such as the number of locomotive units, the horsepower rating of each unit and, of course, the number and weight of freight cars. At low speeds, a commuter train may accelerate at 1.5 miles per hour (mph) per second; a fast freight train may accelerate at 0.3 mph per second. As speed increases, the acceleration rate decreases. A freight train with 4.0 horsepower per ton can accelerate at only about 0.1 mph per second at 70 mph.

The braking system used on trains is the air brake that provides adequate uninterrupted pressure from car to car. The single air hose at the end of each car is manually connected to its neighbor, then the brake system is charged. When braking is required, the pressure in the brake pipe leading back through the train is reduced. This causes the valve on each car to use air from the auxiliary reservoir to build pressure in the brake cylinder, thus applying the brakes. For an emergency application, the brake valve opens the brake pipe to atmospheric pressure and the resulting rapid rate of brake pipe pressure reduction causes the car valves to dump the contents of both auxiliary and emergency reservoirs into the brake cylinder.

Braking distances are dependent on many factors that vary for each train, such as the number and horsepower rating of locomotives; number and weight of cars; adhesion of wheels on rails; speed; and grade. Therefore, the braking distance of a train cannot be stated exactly. An estimate is that a typical 100-car freight train traveling at 60 mph would require more than one mile to stop in emergency braking.

Track

In the United States, railroad track is classified into nine classes based upon maximum allowable operating speed. FRA's Track Safety Standards set maximum train speeds for each class of track, as shown in **Table B-5** and specified in FRA's regulations at 49 CFR 213.9 and 213.307.

Initially, there were many different track gauges; however, in 1863, President Lincoln designated 4 feet, 8.5 inches as the gauge for the railroad to be built to the Pacific coast. Other railroads then began changing to this gauge.

The rolling resistance that provides many of the technological advantages for railroads as a means of transportation is made possible by the steel wheel rolling on a steel rail. This steel-wheel-to-steel-rail contact involves the transfer of pressures from the rail to a steel plate under the rail (tie plate), which spreads the load over a tie, which spreads the load over ballast (crushed rocks or other materials), which spreads the load to a sub-ballast (usually gravels, cinders, or sand), which spreads the load to the subgrade consisting of either the native soil below or some superior material obtained off site.

Table B-5. Maximum Train Speeds by Class of Track³

Class of track	Freight	Passenger
Class 1	10 mph	15 mph
Class 2	25 mph	30 mph
Class 3	40 mph	60 mph
Class 4	60 mph	80 mph
Class 5	80 mph	90 mph
Class 6	110 mph	110 mph
Class 7	125 mph	125 mph
Class 8	160 mph	160 mph
Class 9 ⁴	220 mph	220 mph

Rail is rolled from high-quality steel. Rail being rolled today weighs from 115 to 140 pounds per yard and is 6 to 8 inches high. Currently, the standard rail length is 78 feet. In track, these rails are held together by bolted joint bars or are welded end-to-end in long strings. Bolted joints are, however, less rigid than the rest of the rail so that the rail ends wear more rapidly. Continuously welded rail is often used today, particularly on mainline tracks. Rail is welded into lengths of about 1,500 feet and taken to the point of installation. The remaining joints can be eliminated by field welding in place.

The steel rails are spiked to ties typically made of wood with preservative impregnated to prevent decay. The ties hold the rails to gauge, support the rails, distribute the load to the ballast, and provide flexibility to cushion impacts of the wheels on the rail. Pre-stressed concrete ties have come into greater use on railroads in recent years.

Spikes or other rail fasteners are used to fix the rail to the ties for the primary purpose of preventing the rail from shifting sideways. Because rail tends to move lengthwise, rail anchors can be used, particularly on heavy-duty track.

Ballast is used to hold the ties in place, to prevent lateral deflections, and to spread out the load. Ballast should be able to resist degradation from the effects of tie motion that generates “fines” that may “cement” into an impervious mass. FRA regulations (49 CFR 213.103) require that ballast provide good drainage, which is especially important for the strength of the subgrade and prevents mud from working its way up to contaminate the ballast.

Railway track is normally maintained by track gangs (small groups of maintenance-of-way employees) for small scale repairs or by sophisticated, high production, mechanized equipment for large scale projects. As an example, track surface is maintained by tamping machines that raise the track and compact the ballast under the ties. In this process, it is often necessary to raise the track a few inches. The best track stability will occur if this raise can continue through the crossing area instead of leaving a dip in the track. Lowering track is a very costly operation and can lead to subgrade instability problems.

³ Trains operating at Class 6–9 speeds must be qualified in accordance with 49 CFR sections 213.329 and 213.345. There are additional requirements for freight trains and trains operating at or above 125 mph, as provided in 49 CFR 213.307(a).

⁴ Federal Register Volume 78, Issue 49 (March 13, 2013). <https://www.govinfo.gov/app/details/FR-2013-03-13/2013-04679>.

Similar to highways, railroad track is classified into several categories dependent on its utilization in terms of traffic flow. Main tracks are used for through train movements between and through stations and terminals. Branch lines typically carry freight from its origin to the mainline on which it moves to its destination or to another branch line to its destination. Passing tracks, normally called sidings, are used for meeting and passing trains. Side tracks and industrial tracks are generally used to store cars and to load or unload them. **Table B-6** provides a tabulation indicating the number of tracks present on various categories of track.

Table B-6. Public At-Grade Crossings by Type of Track, 2017

No. of Tracks	Type of Track				
	Main	Siding	Yard	Transit	Industry
0	14,825	80,152	79,972	85,831	77,313
1	102,963	7,710	4,911	110	8,454
2	10,441	924	1,119	130	889
3	543	177	330	0	149
4	61	47	146	1	34
5	12	11	67	0	15
> 5	28	8	60	0	29
Total	128,873	89,029	86,605	86,072	86,883

Source: Unpublished data from Federal Railroad Administration.⁵

⁵ Updated data can be found on the FRA's Office of Safety Analysis website (also known as safety data) at <https://safetydata.fra.dot.gov>

C. APPENDIX—ASSESSMENT OF CROSSING SAFETY AND OPERATION

COLLECTION AND MAINTENANCE OF DATA

The FHWA requires each State to develop and implement a HSIP that consists of three components: planning, implementation, and evaluation. The process for improving safety and operations at highway-railroad grade crossings consists of the same three components and may be considered part of a State's HSIP.

FHWA policy and procedures for an HSIP are contained in the Federal-Aid Policy Guide (FAPG) Title 23—Code of Federal Regulations (and Non-Regulatory Supplements).⁽⁹³⁾ The purpose of an HSIP is to reduce fatalities and serious injuries on all public roads, including the development of a data-driven Strategic Highway Safety Plan (SHSP), Railway-Highway Crossings Program, and program of highway safety improvement projects. Types of safety data includes, but are not limited to, crash, roadway characteristics, and traffic data on all public roads. For railway- highway crossings, safety data also includes the characteristics of highway and train traffic, licensing, and vehicle data.

USDOT Grade Crossing Inventory

Under FRA regulations in subpart F to 49 CFR Part 234, railroads are required to report highway-rail and pathway crossings to the National Crossing Inventory.⁽⁹⁴⁾ The USDOT National Highway-Rail Crossing Inventory was developed in the early 1970s through the cooperative efforts of FHWA, the FRA, the AAR, individual States, and individual railroads. Originally this was a voluntary effort by the various stakeholders. A PDF file of the USDOT Crossing Inventory Form can be downloaded from: <https://www.fra.dot.gov/eLib/Details/L16197>. The railroads assign each crossing a unique DOT Crossing Inventory Number consisting of six numeric characters and an alphabetic character. To obtain new DOT Crossing Inventory Numbers, railroads should email RequestDOTGXNumber@dot.gov and provide the following:

- Name of person requesting the number(s)
- Title of person requesting the number(s)
- Email address of the person request the number(s)
- Railroad name
- Railroad mailing address
- Number of DOT crossing numbers(s) requested

The FRA is the custodian for the Crossing Inventory database. The data for the Inventory is provided by the railroad and States. The railroads and States can find the [Guide for Preparing USDOT Crossing Inventory Forms](#) (Guide). The Guide explains what information is required for each box of the Inventory Form. The Guide also includes information on what fields of the Inventory are the responsibility of the railroads and what fields are the responsibility of the States.

According to the Guide, a railroad must update the Crossing Inventory record for each open at-grade crossing at least once every three years; however certain changes require more frequent updates:

- New crossings must be reported to the Inventory within 6 months of becoming operational
- Closure or sale of a crossing must be reported to the Inventory within 3 months
- Change in crossing surface must be reported to the Inventory within 3 months
- Changes in warning devices must be reported to the Inventory within 3 months

To maintain consistency with accident history and other data, once an Inventory Number is assigned to a crossing it should not be assigned to another location.

Highway-Rail Grade Crossing Collision Data

Information on highway-rail grade crossing collisions is also needed to assess safety and operations. Data on collisions involving trains are essential in identifying crossings with safety problems. In addition, data on collisions not involving trains but occurring at or near a crossing are useful. For example, non-train-involved collisions may indicate a deficiency in stopping sight distance such that a vehicle suddenly stops at a crossing, causing the following vehicle to hit the leading vehicle in the rear.

Collision data is available from several sources, including State and local police and FRA. In addition, the NHTSA and FHWA maintain some information on crossing collisions. The FRA's Office of Safety Analysis has a website (also known as Safetydata) where their updated data is uploaded. This can be accessed at <https://safetydata.fra.dot.gov>.

Information regarding accidents, reporting, and investigations can be accessed at <https://www.fra.dot.gov/Page/P0037>.

The FRA Guide for Preparing Accident/Incident Reports can be found online at https://www.fra.dot.gov/eLib/details/L18093#p1_z5_gD_kpreparing%20accident. A PDF file of the Accident Report Form for Federal Railroad Administration can be downloaded from: https://safetydata.fra.dot.gov/officeofsafety/publicsite/Newregulation.aspx?doc=F6180_54_Expires06302020.pdf. NHTSA maintains a database on all fatal highway traffic collisions, including those occurring at highway-rail grade crossings. The FARS database can be accessed at <https://www-fars.nhtsa.dot.gov/Main/index.aspx> (see **Figure C-1**).

The FMCSA maintains data on highway collisions involving motor carriers. An accident is “an occurrence involving a commercial motor vehicle operating on a highway engaged in interstate or intrastate commerce which results in (i) a fatality; (ii) bodily injury to a person who, as a result of the injury, immediately receives medical treatment away from the scene of the accident; or, (iii) one or more motor vehicles incurring disabling damage as a result of the accident, requiring the motor vehicle(s) to be transported away from the scene by a tow truck or other motor vehicle” (49 CFR 390.5).⁽⁹⁵⁾

In the past, FMCSA required motor carriers to report crashes directly to the agency. This is no longer the case. This information is now forwarded by States; however, motor carriers must

maintain accident registers for three years after the date of each accident occurring on or after April 29, 2003 (49 CFR 390.15).

Collisions involving the transport of hazardous materials are reported to PHMSA. The PHMSA develops regulatory programs to help ensure the safe and secure movement of hazardous materials. The PHMSA also enforces the Federal Motor Carrier Safety Regulations which can be found in 49 CFR 350-399.

Significant transportation accidents are investigated by the NTSB. The NTSB issues a report for each accident investigated. The report presents the circumstances of the accident, the data collected, and the analysis of the data as well as conclusions, which are identified as “findings” of NTSB. In addition, NTSB issues specific recommendations to various parties for improvement of safety conditions.

DEPARTMENT OF TRANSPORTATION FEDERAL RAILROAD ADMINISTRATION (FRA)		RAIL EQUIPMENT ACCIDENT/INCIDENT REPORT		OMB No. 2130-0500	
1. Name of Reporting Railroad		1a. Alphabetic Code		1b. Railroad Accident/Incident No.	
2. Name of Other Railroad or Other Entity with Consist Involved		2a. Alphabetic Code		2b. Railroad Accident/Incident No.	
3. Name of Railroad or Other Entity Responsible for Track Maintenance (single entry)		3a. Alphabetic Code		3b. Railroad Accident/Incident No.	
4. U.S. DOT Grade Crossing Identification Number		5. Date of Accident/Incident Month Day Year		6. Time of Accident/Incident AM <input type="checkbox"/> PM <input type="checkbox"/>	
7. Type of Accident/Incident (single entry in code box)		8. HAZMAT Cars Damaged/Dealted		9. Cars Releasing HAZMAT	
9. HAZMAT Cars Damaged/Dealted		10. Cars Releasing HAZMAT		11. People Evacuated	
13. Nearest City/Town		14. Milepost (to nearest tenth)		15. State Abbr. Code	
16. County		17. Temperature (F) (Specify if minute)		18. Visibility (single entry) Code	
19. Weather (single entry) Code		20. Type of Track Code		21. Track Name/Number	
22. FRA Track Class (F-G, X) Code		23. Annual Track Density (gross feet in millions)		24. Time Table Direction Code	
25. Type of Equipment Consist (single entry)		26. Was Equipment Abandoned? 1. Yes 2. No		27. Train Number/Symbol Code	
28. Speed (recorded speed if available) MPH Code		29. Type of Territory (enter code(s) that apply) Signalization (Mandatory) 1. Signalized 2. Not Signalized Method of Operation/Authority for Movement (Mandatory) 1. Signal Indication 2. Dotted Train Control 3. Restricted Lanes 4. Block-Register Trolley 5. Other Than Main Track Supplemental/Agent Codes (mandatory) * Mandatory to the extent that all applicable codes are entered		30. Remotely Controlled Locomotive? 0 = Not a remotely controlled locomotive 1 = Remote control portable transmitter 2 = Remote control tower operation 3 = Remote control portable transmitter more than one remote control transmitter	
31. Principal Car/Unit a. Initial and Number b. Position in Train c. Loaded (yes/no)		32. If railroad employee(s) tested for drug/alcohol use, enter the number that were positive in the appropriate box.		33. Was this consist transporting passengers? (y/n)	
34. Locomotive Units (Circle EMS, DMU, and Cab Car Locomotives) a. Head End b. Manual c. Remote d. Manual e. Remote		35. Cars (Circle DMU, DMU, and Cab Car Locomotives) a. Loaded b. Freight c. Freight d. Pass. e. Caboose		36. Equipment Damage This Consist: 37. Track, Signal, Way, or Structure Damage	
40. Engineers/Operators 41. Firemen 42. Conductors 43. Brakemen		44. Engineer/Operator Hrs. Mins.		45. Conductor Hrs. Mins.	
Casualties to: 46. Railroad Employees 47. Train Passengers 48. Others		49a. Special Study Block A		49b. Special Study Block B	
50. Latitude		51. Longitude		52. Narrative Description (Be specific; and outline on separate sheet if necessary)	
53. Type/Printed Name of Reporter		54. Signature		55. Date	
NOTE: This report is part of the reporting railroad's accident report pursuant to the accident reports statute and so such shall not be admitted as evidence or used for any purpose in any suit or action for damages growing out of any matter mentioned in said report. * 49 U.S.C. 20303; See 49 C.F.R. 225.7(f)(3)					
This collection of information is mandatory under 49 CFR 211, and is used by FRA to monitor national rail safety. Public reporting burden is estimated to average 2 hours per response, including the time for reviewing instructions, searching existing databases, gathering and maintaining the data needed, and completing and reviewing the collection of information. The information collected is a matter of public record, and no confidentiality is promised to any respondent. Please note that an agency may not conduct or sponsor, and a person is not required to respond to a collection of information unless it displays a currently valid OMB control number. The OMB control number for this collection is 2130-0500.					
FORM FRA F 6180.54 (Rev. 08/10)		OMB approved 6/2/2017, Approval expires 6/30/2020			

Figure C-1. Rail Equipment Accident/Incident Report Form

Source: FRA, Office of Safety (website accessed) https://safetydata.fra.dot.gov/officeofsafety/publicsite/Newregulation.aspx?doc=F6180_54_Expires06302020.pdf

HAZARD INDICES AND ACCIDENT PREDICTION FORMULAE

A systematic method for identifying crossings that have the most need for safety and/or operational improvements is essential to ensure that federal and State funds for highway-railroad grade crossing improvement projects are spent at the locations that are considered to be most in need of improvement. Considerations for prioritizing locations for improvement include the following:

- The potential reduction in the number and/or severity of collisions
- The cost of the projects and the resources available
- The relative hazard of public highway-rail grade crossings based on a hazard index formula
- Collision history of a particular crossing location
- On-site inspections of public crossings
- The potential danger to large numbers of people at public crossings used on a regular basis by passenger trains, school buses, transit buses, pedestrians, bicyclists, or by trains and/ or motor vehicles carrying hazardous materials
- Other criteria as appropriate in each State

To support the prioritization process, various hazard indices and collision prediction formulae have been developed to assist with ranking the hazard potential of highway-rail grade crossings. A hazard index ranks crossings in relative terms (the higher the calculated index, the more hazardous the crossing), whereas the collision prediction formulae are intended to compute the actual collision occurrence frequency at the crossing. These are commonly used to identify crossings to be investigated in the field. A 2017 review of State DOT hazard ranking practices found that 39 out of 50 States (78 percent) utilized some type of hazard ranking index, collision prediction formula, or other systematic method for prioritization.⁽⁹⁶⁾ This section discusses the application of hazard index techniques and crash prediction formula techniques for highway-railroad grade crossing hazard ranking. Procedures for conducting the on-site inspection are discussed in the next section.

It should be noted that hazard indices or crash prediction formulas are not the exclusive method used by State DOTs and other agencies to identify hazardous highway-railroad grade crossings. Crossings may also be selected for field investigation because of requests or complaints from the public. State district offices, local governmental agencies, other State agencies, and railroads may also request that a crossing be investigated for improvement. A change in highway or railroad operations over a crossing may justify the consideration of that crossing for improvement. For example, a new residential or commercial development may increase the volume of highway traffic over a crossing such that its hazard index would increase. Other crossings may be selected for a field investigation because they are utilized by buses, passenger trains, and vehicles transporting hazardous materials. Some States incorporate these considerations into a hazard index, thus providing an objective means of assessing the potential danger to large numbers of people. Finally, professional judgment on the part of the highway-rail intersection safety specialist in determining the appropriateness of a particular warning device project at a particular crossing location should also be considered in the process.

Hazard Index

The hazard index approach to prioritization of grade crossing locations requires the analyst to calculate a ranking metric or value that will provide insight into the hazard level of a particular crossing relative to other crossing locations. A commonly used index is the New Hampshire Hazard Index ranking methodology. Historically, the New Hampshire Hazard Index was the most common hazard ranking model used by State DOTs. A 2017 review of State DOT grade crossing hazard ranking practices found that at least seven States were utilizing the New Hampshire Hazard Index, or a State-specific variation thereof, for prioritization activities.⁽⁹⁶⁾ The New Hampshire Hazard Index is the most basic form of the hazard index model type consisting of the exposure index (cross product of the AADT and train volume) with a “protection factor” adjustment for the type of warning device provided at the crossing. The New Hampshire Hazard Index formula is as follows:

HI = (V) * (T) * (PF), where:

- HI = Calculated Hazard Index Value
- V = Highway Traffic Volume at Crossing (AADT)
- T = Train Movements per Day at Crossing
- PF = Protection Factor based on Warning Device Type

The original New Hampshire Hazard Index formula utilized protection factors of 0.1 for automatic gates, 0.6 for flashing lights, and 1.0 for signs only. Some States have revised these protection factors to include more refined levels of protection available at a crossing. For example, the Michigan DOT utilizes the New Hampshire Hazard Index with 13 different values of protection factors based on the presence of additional warning device features.⁽⁹⁷⁾ The primary advantage of the hazard index approach is that it is easily understood. An increase in either highway traffic volume or train traffic volume increases the risk of a crash at a crossing location; that risk is lower if more sophisticated protective devices are present at that location. The primary disadvantage of the hazard index approach is that the hazard index value is calculated relative to other crossings; consequently, the hazard index value for a single crossing without reference to other crossings has limited usefulness for prioritization.

Crash Prediction Model

The crash prediction model approach to prioritization of grade crossing locations utilizes a mathematical formula to predict the expected annual crash frequency at a crossing location; this value is used as the ranking metric for prioritization purposes. A crash prediction model is intended to estimate, in absolute terms, the likelihood of a collision occurring over a given period of time based on the given conditions at the crossing. Some crash prediction models also allow for the severity of crashes to be predicted. The structure of the crash prediction models includes all the characteristics or factors that are thought to significantly influence the risk of a crash at a grade crossing. A crash prediction model can also be used to either rank crossings or identify potential high-accident locations for further review. Additionally, the model output can be combined with economic data on crash costs to support a comprehensive economic analysis of proposed grade crossing improvement projects.

A 2017 review of State DOT grade crossing hazard ranking practices found that at approximately half of the States utilized a crash prediction formula of some type for prioritization activities. Crash prediction formulas currently in use by State DOTs include the USDOT Accident Prediction Model, the NCHRP 50 Accident Prediction Model, the Peabody-Dimmick formula. Additionally, some States have developed crash prediction models based on State-specific crash trends and experiences. Among the crash prediction models currently in use, the USDOT Accident Prediction Model is the most prevalent, with at least 19 States (38 percent) reporting the use of this model for prioritization activities. Additional details of the USDOT Accident Prediction Model are presented in this section; details of other, less commonly-used crash prediction models, are available elsewhere.⁽⁹⁶⁾

USDOT Accident Prediction Model

The USDOT Accident Prediction Model is an accident prediction model that was developed in the mid-1970s to support a comprehensive grade crossing project selection process known as the *Rail-Highway Crossing Resource Allocation Procedure*.⁽⁹⁸⁾ The most up-to-date version of the USDOT Accident Prediction Model is described in detail in the FRA's [GradeDec.net Crossing Evaluation Tool Reference Manual](#), which was published in 2014.⁽⁹⁹⁾ The USDOT crash prediction model is a multi-stage calculation that combines three independent calculations to produce a crash prediction value. The basic formula provides an initial hazard ranking based on a crossing's characteristics, like other formulae such as the Peabody-Dimmick formula and the New Hampshire Index. The second calculation utilizes the actual collision history at a crossing over a determined number of years to produce a collision prediction value. This procedure assumes that future collisions per year at a crossing will be the same as the average historical collision rate over the time period used in the calculation. The third equation adds a normalizing constant, which is adjusted periodically to keep the procedure matched with current collision trends. If desired, the analyst can also predict the annual frequency of crashes by crash severity (fatality, injury, or property damage only).

The basic steps to utilize the USDOT Accident Prediction Model are as follows:

- Step 1: Gather Required Input Data
- Step 2: Generate Preliminary Crash Frequency Estimate
- Step 3: Adjustment for Crash History
- Step 4: Normalizing Constant Adjustment for Crash Trends
- Step 5: Estimate of Crash Severity (Optional)

The specific requirements for each step listed above are described in the following sections. Specific formula information and numerical parameters are obtained directly from the FRA [GradeDec.net](#) manual.⁽⁹⁹⁾ The FRA has provided a web-based tool, known as the [Web Accident Prediction System](#), where highway-rail intersection safety specialists may view current estimates of the predicted annual crash frequency for any public highway-rail intersection in the national inventory database.

ENGINEERING STUDY

Federal requirements (23 U.S.C. 130(d)) dictate that each State develop a crossing program based on the following:

- The potential reduction in collisions or collision severities
- The project costs and available resources
- The relative hazard of each crossing based on a hazard index formula
- An onsite inspection of each candidate crossing

An engineering study is the comprehensive analysis and evaluation of available pertinent information, and the application of appropriate principles, provisions, and practices. MUTCD Part 1A.13 requires that an engineering study shall be performed by an engineer, or by an individual working under the supervision of an engineer, through the application of procedures and criteria established by the engineer. Based on a review of these conditions, an assessment of existing and potential hazards can be made. If safety deficiencies are identified, countermeasures can be recommended.

An engineering study should be conducted of highway-rail crossings that have been selected from the priority list. The purpose of this study is to accomplish the following:

- Review the crossing and its environment
- Identify the nature of any problems
- Recommend alternative improvements

Diagnostic Team Study Method

The Diagnostic Team Study Method is the procedure adopted in FHWA's *Highway Safety Engineering Study Procedural Guide* and adopted in concept by several States.⁽¹⁰⁰⁾ This survey procedure utilizes experienced individuals from several sources. The procedure involves the Diagnostic Team's evaluation of the crossing as to its deficiencies and consensus as to the recommended improvements.

The primary factors to consider when determining stakeholders to be a part of the Diagnostic Team are that the team is interdisciplinary, and representative of all groups having responsibility for the safe operation of crossings. This enables each of the vital factors relating to the operational and physical characteristics of the crossing to be identified properly. Individual team members are selected based on their specific expertise and experience. The overall structure of the team is built upon the following three desired areas of responsibility:

- Local responsibility
- Administrative responsibility
- Advisory capability

For the purpose of the Diagnostic Team, the operational characteristics of crossings can be classified into the following three areas:

Traffic Operations

This area includes both vehicular and train traffic operation. The responsibilities of highway traffic engineers and railroad operating personnel chosen for team membership include, among other criteria, specific knowledge of highway and railroad safety, types of vehicles and trains, and their volumes and speeds.

Traffic Control Devices

Highway maintenance engineers, signal control engineers, and railroad signal engineers provide the best source for expertise in this area. Responsibilities of these team members include knowledge of active traffic control systems, interconnection with adjacent signalized highway intersections, traffic control devices for vehicle operations in general and at crossings, and crossing signs and pavement markings.

Administration

Many issues relating to crossing safety also involve the apportionment of administrative and financial responsibility. This should be reflected in the membership of the Diagnostic Team. The primary responsibility of these members is to advise the team of specific policy and administrative rules applicable to the modification of crossing traffic control devices.

To ensure appropriate representation on the Diagnostic Team, it is suggested that the team be comprised of at least a traffic engineer with safety experience as well as a railroad signal engineer. Following are other disciplines that might be represented on the Diagnostic Team:

- Railroad administrative official
- Highway administrative official
- Human factors engineer
- Law enforcement officer
- Regulatory agency official
- Railroad operating official
- Local government agencies
- Regional transportation planning organization
- Pedestrian/bicycle coordinator
- Emergency services representative
- Commercial motor carrier
- Stakeholders and special interest groups

The Diagnostic Team should study all available data (including as-built plans and/or proposed improvement plans that may impact the location) and inspect the crossing and its surroundings with the objective of determining the conditions that affect safety and traffic operations. In conducting the study, a questionnaire is recommended to provide a structured account of the crossing characteristics and their effect on safety. Some States are now using automated diagnostic review forms to facilitate the collection, storage, and analysis of crossing data. **Figure C-2** shows a sample questionnaire, which can be altered to fit individual agency needs. The questionnaire shown in **Figure C-2** is divided into the following four sections:

- Distant approach and advance warning
- Immediate highway approach
- Crossing proper
- Summary and analysis

Important considerations when studying traffic flow and operations at a highway-rail grade crossing are traffic volumes (daily and peak hour); speeds; the mix of vehicle types; intersecting volumes and turning movements at intersections near the crossing; the capacity of the road; delays; and the formation of any traffic queues. These should be reviewed in light of current conditions and how they might be affected by changes at the crossing.

Key concerns are routing and access for emergency vehicles and the use of the crossing by special vehicles such as low clearance vehicles, buses, and trucks transporting hazardous materials.

Locational Data:

Street Name: _____

City: _____

Railroad: _____

Crossing Number: _____

VEHICLE DATA: No. of Approach Lanes: _____

Approach Speed Limit: _____ AADT: _____

Approach Curvature: _____ Approach Gradient: _____

TRAIN DATA: No. of Tracks: _____ Train Speed Limit: _____

Trains Per Day: _____

Track Gradients: _____

SECTION I—Distance Approach and Advance Warning

1. Is advance warning of railroad crossing available? If so, what devices are used?

2. Do advance warning devices alert drivers to the presence of the crossing and allow time to react to approaching train traffic?

3. Do approach grades, roadway curvature, or obstructions limit the view of advance warning devices? _____ If so, how?

4. Are advance warning devices readable under night, rainy, snowy, or foggy conditions?

SECTION II—Immediate Highway Approach

1. What maximum safe approach speed will existing sight distance support?

2. Is that speed equal to or above the speed limit on that part of the highway?

3. If not, what has been done, or reasonably could be done, to bring this to the driver's attention?

4. What restrictive obstructions to sight distance might be removed?

5. Do approach grades or roadway curvature restrict the driver's view of the crossing?

6. Are railroad crossing signals or other active warning devices operating properly and visible to adequately warn drivers of approaching trains?

SECTION III—Crossing Proper

1. From a vehicle stopped at the crossing, is the sight distance down the track to an approaching train adequate for the driver to cross the tracks safely?

2. Are nearby intersection traffic signals or other control device affecting the crossing operation? If so, how?

3. Is the stopping area at the crossing adequately marked?

4. Do vehicles required by law to stop at all crossings present a hazard at the crossing? _____
Why? _____

5. Do conditions at the crossing contribute to, or are they conducive to, a vehicle stalling at or on the crossing?

6. Are nearby signs, crossing signals, etc. adequately protected to minimize hazards to approaching traffic?

7. Is the crossing surface satisfactory? _____ If not, how and why?

8. Is surface of highway approaches satisfactory? _____
If not, why?

SECTION IV—Summary and Analysis

1. List major attributes of the crossing which may contribute to safety:

2. List features which reduce crossing safety:

3. Possible methods for improving safety at the crossing (including closure, if practicable):

4. Overall evaluation of crossing:

5. Other comments:

Figure C-2. Sample Questionnaire for Diagnostic Team Evaluation

To help the Diagnostic Team identify viewpoints of reference for the field evaluation, traffic cones can be placed on the approaches, as shown in **Figure C-3**.

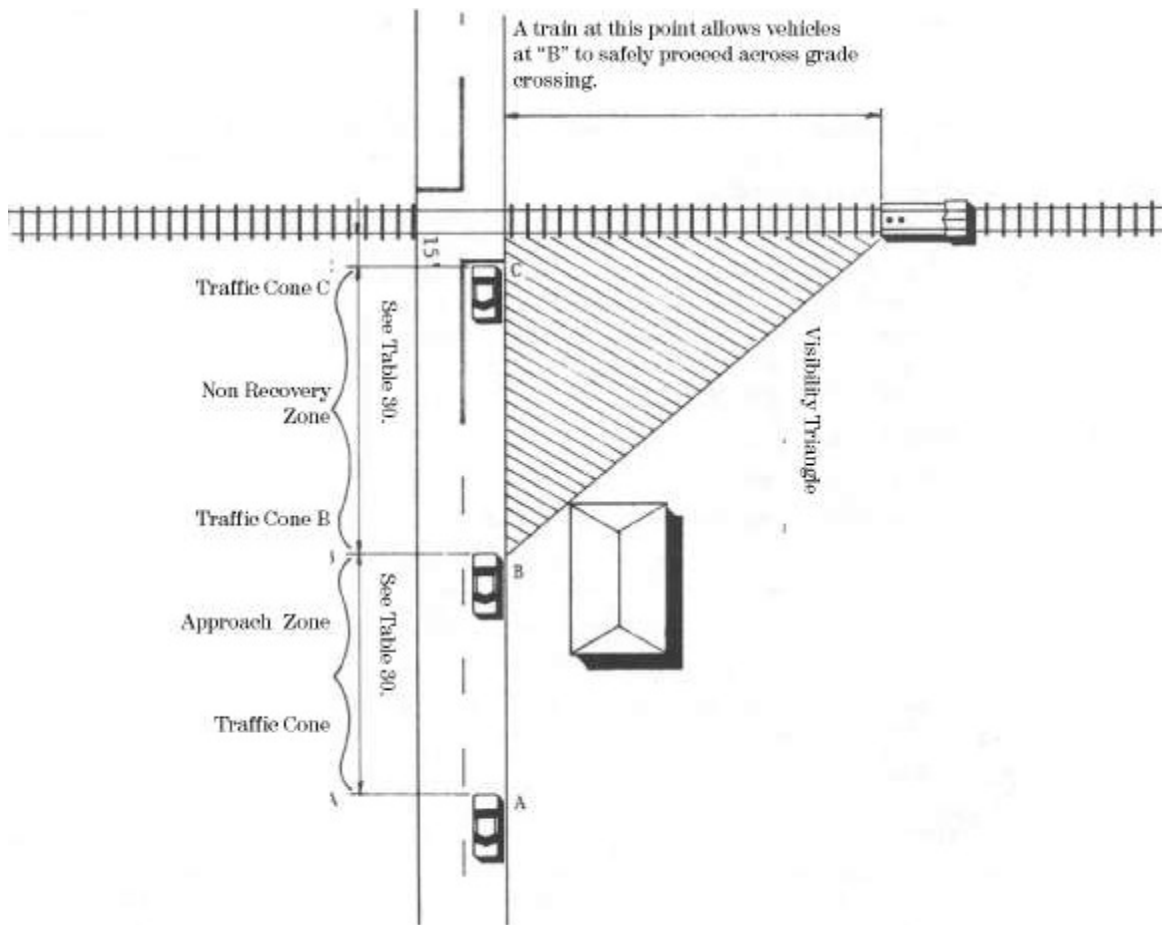

Figure C-3. Study Positions for Diagnostic Team

Crossing Approach Zone

Cone A is placed at the point where the driver first obtains information that there is a crossing ahead. This distance is also the beginning of the approach zone. Usually, this information comes from the advance warning sign, the pavement markings, or the crossing itself. The distance from the crossing is based on the decision sight distance (refer to bottom row of **Table C-1**), which is the distance required for a driver to detect a crossing and to formulate actions needed to avoid colliding with trains. In calculating sight distances, a level approach is assumed. If this is not the case, an allowance should be made for the effects of positive or negative approach grades.

Table C-1. Sight Distances for Combinations of Highway Vehicle and Train Speeds

Train Speed (MPH)	Case B Departure from Stop	Case A Moving Vehicle							
		Vehicle Speed (MPH)							
—	0	10	20	34	40	50	60	70	80
Distance Along Railroad Crossing from d_r (ft)									
10	255	155	110	102	102	106	112	119	127
20	509	310	220	203	205	213	225	239	254
30	794	465	331	305	307	319	337	358	381
40	1,019	619	441	407	409	426	450	478	508
50	1,273	774	551	509	511	532	562	597	635
60	1,528	929	661	610	614	639	675	717	763
70	1,783	1,084	771	712	716	745	787	836	890
80	2,037	1,239	882	814	818	852	899	956	1,017
90	2,292	1,394	992	915	920	958	1,012	1,075	1,144
Distance Along Highway from Crossing, d_H (ft)									
—	—	69	135	220	324	447	589	751	931

Source: American Association of State Highway and Transportation Officials (AASHTO): *A Policy on Geometric Design of Highways and Streets, 7th Edition, Washington, DC, 2018.*

Safe Stopping Point

Cone B is placed at the point where the approaching driver has adequate corner sight distance to see an approaching train so that a safe stop can be made if necessary. This point is located at the end of the approach zone and the beginning of the non-recovery zone. Distances to point B are based on the design vehicle speed and maximum authorized train speed (refer to “Case A—Moving Vehicle” in Table C-1).

Stop Line

Cone C is placed at the stop line, which is assumed to be 15 feet from the near rail of the crossing, or 8 feet from the gate if one is present.

The questions in Section I of the questionnaire (refer to **Figure C-2**) are concerned with the following:

- Driver awareness of the crossing
- Visibility of the crossing
- Effectiveness of advance warning signs and signals
- Geometric features of the highway

When responding to questions in this section, the crossing should be observed from the beginning of the approach zone, at traffic cone A.

The questions in Section II of the questionnaire (refer to **Figure C-2**) are concerned with whether the driver has sufficient information to detect an approaching train and make correct decisions about crossing safely. Observations for responding to questions in this section should be made from cone B. Factors considered by these questions include the following:

- Driver awareness of approaching trains
- Driver dependence on crossing signals
- Obstruction of view of train's approach
- Roadway geometrics diverting driver attention
- Potential location of standing railroad cars
- Possibility of removal of sight obstructions
- Availability of information for stop or go decision by the driver

The questions in Section III of the questionnaire (refer to **Figure C-2**) apply to observations adjacent to the crossing, at cone C. Of concern, especially when the driver must stop, is the ability to see down the tracks for approaching trains. Intersecting streets and driveways should also be observed to determine whether intersecting traffic could affect the operation of highway vehicles over the crossing. Questions in this section relate to the following:

- Sight distance down the tracks
- Pavement markings
- Conditions conducive to vehicles becoming stalled or stopped on the crossing
- Operation of vehicles required by law to stop at the crossing
- Signs and signals as fixed object hazards
- Opportunity for evasive action by the driver

In Section IV of the questionnaire (see **Figure C-2**), the Diagnostic Team is given the opportunity to do the following:

- List major features that contribute to safety
- List features that reduce crossing safety
- Suggest methods for improving safety at the crossing
- Give an overall evaluation of the crossing
- Provide comments and suggestions relative to the questionnaire

In addition to completing the questionnaire, team members should take photographs of the crossing from both the highway and the railroad approaches.

Current and projected vehicle and train operation data should be obtained from the team members. Information on the use of the crossing by buses, school buses, trucks transporting hazardous materials, and passenger trains should be provided. The evaluation of the crossing should include a thorough evaluation of collision frequency, collision types, and collision circumstances. Both train-vehicle collisions and vehicle-vehicle collisions should be examined.

Team members should drive each approach several times to become familiar with all conditions that exist, at or near, the crossing. All traffic control devices (signs, signals, markings, and train detection circuits) should be examined as part of this evaluation. If the crossing is equipped with signals, the railroad signal engineer should activate them so that their alignment and light intensity may be observed.

The MUTCD should be a principal reference for this evaluation. Also, *A User's Guide to Positive Guidance* provides information for conducting evaluations of traffic control devices.⁽¹⁰¹⁾

After the questionnaire has been completed, the team is reassembled to discuss it. Each member should summarize his or her observations pertaining to safety and operations at the crossing. Possible improvements to the crossing may include the following:

- Closing of crossing—available alternate routes for highway traffic
- Site improvements—removal of obstructions in the sight triangle, highway realignment, improved cross section, drainage, or illumination
- Crossing surfaces—rehabilitation of the highway structure, the track structure, or both; installation of drainage and subgrade filter fabric; adjustments to highway approaches; and removal of retired tracks from the crossing
- Traffic control devices—installation of passive or active control devices and improvement of train detection equipment

The results and recommendations of the Diagnostic Team should be documented. Recommendations should be presented promptly to programming and implementation authorities. Current practice is to use a team in order to ensure all stakeholder perspectives are included.

Sight Distance Computation

Available sight distances help determine the safe speed at which a vehicle can approach and clear a crossing. Refer to the AASHTO “Green Book” for additional information.⁽⁸⁷⁾ The following three sight distances should be considered (refer to **Figures C-4 and C-5**):

- Distance ahead to the crossing—Approach stopping sight distance
- Distance to and along the tracks on which a train might be approaching the crossing from either direction—Corner sight distance
- Sight distance along the tracks in either direction from a vehicle stopped at the crossing—Clearing sight distance

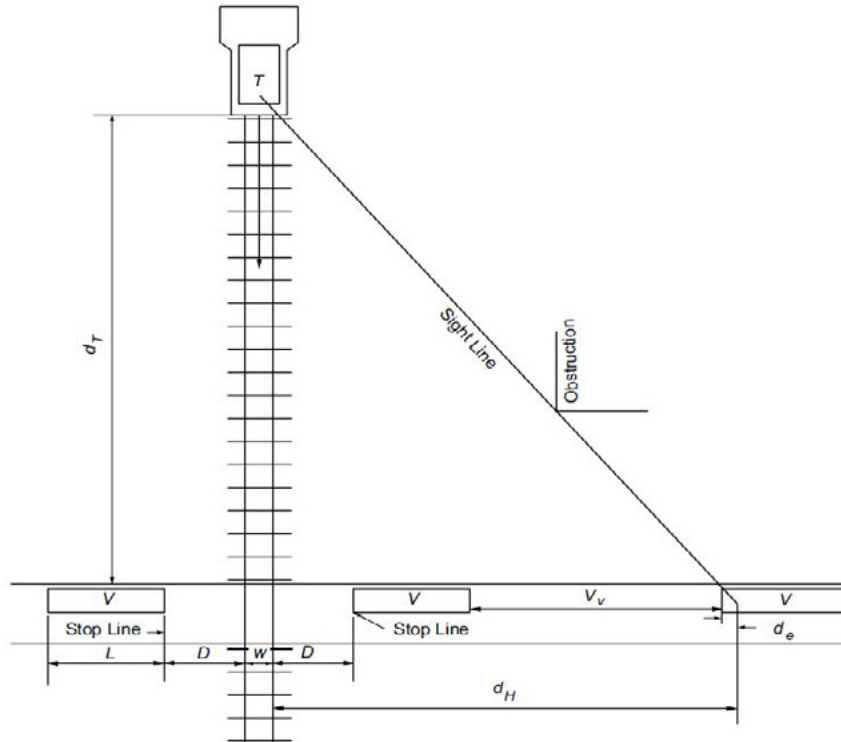

Figure C-4. Sight Distance for Moving Vehicle

Source: American Association of State Highway and Transportation Officials (AASHTO): *A Policy on Geometric Design of Highways and Streets, 7th Edition*, (Figure 9-77), Washington DC, 2018.

The formula for computing safe stopping distance for vehicles approaching a crossing is set forth in the following formula (refer to **Figure C-4**):

$$d_H = AV_v t + \frac{BV_v^2}{a} + D + d_e$$

where:

- A = constant = 1.47
- B = constant = 1.075
- d_H = sight distance measured along the highway from the nearest rail to the driver of a vehicle, which allows the vehicle to be safely stopped without encroachment of the crossing area, feet
- V_v = velocity of the vehicle, mph
- t = perception-reaction time, seconds, assumed to be 2.5 seconds
- a = driver deceleration, assumed to be 11.2 feet per second²
- D = distance from the stop line or front of vehicle to the near rail, assumed to be 15 feet
- d_e = distance from the driver to the front of the vehicle, assumed to be 8 feet

The minimum safe sight distances, d_H , along the highway for selected vehicle speeds are shown in the bottom line of **Table C-1**. As noted, these distances were calculated for level approaches to 90-degree crossings and should be increased for less favorable conditions.

The second sight distance utilizes a so-called “sight triangle” in the quadrants on the vehicle approach side of the track. This triangle is formed by:

- The distance (d_H) of the vehicle driver from the track
- The distance (d_T) of the train from the crossing

This sight triangle is depicted in **Figure C-4**. The distance along the along the railroad (d_T) is determined by the vehicle speed and maximum timetable train speed and is set forth in the following formula:

$$d_T = \frac{V_T}{V_V} \left((A)V_v t + \frac{BV_v^2}{a} + 2D + L + W \right)$$

where:

- d_T = sight distance along the railroad tracks to permit the vehicle to cross and be clear of the crossing upon arrival of the train
- V_T = velocity of the train, mph
- V_v = velocity of the vehicle, mph
- A = constant = 1.47
- B = constant = 1.075
- t = perception-reaction time, seconds, assumed to be 2.5 seconds
- a = driver deceleration, assumed to be 11.2 feet per second
- D = distance from the stop line or front of vehicle to the near rail, assumed to be 15 feet
- L = length of vehicle, assumed to be 65 feet
- W = distance between outer rails (for a single track, this value is 5 feet)

Clearing Sight Distance

In the case of a vehicle stopped at a crossing, the driver needs to see both ways along the track to determine whether a train is approaching and to estimate its speed. The driver needs to have a sight distance along the tracks that will permit sufficient time to accelerate and clear the crossing prior to the arrival of a train, even though the train might come into view as the vehicle is beginning its departure process.

Figure C-5 illustrates the maneuver. These sight distances, for a range of train speeds, are given in the column for a vehicle speed of zero in **Table C-1**. These values are obtained from the following formula:

$$d_T = 1.47V_T \left(\frac{V_G}{a_1} + \frac{L + 2D + W - d}{V_G} + J \right)$$

where:

- d_T = sight distance along the railroad tracks to permit the vehicle to cross and be clear of the crossing upon arrival of the train
- V_T = velocity of the train, mph
- V_G = maximum speed of vehicle in selected starting gear; assumed to be 8.8 feet per second
- a_1 = acceleration of vehicle in starting gear, assumed to be 1.47 feet per second²
- D = distance from the stop line or front of vehicle to the near rail, assumed to be 15 feet
- L = length of vehicle, assumed to be 65 feet (see **Table C-2** for further clarification)
- W = distance between outer rails (for a single track, this value is 5 feet)
- d = distance the vehicle travels while accelerating to maximum speed in first gear, assumed to be 26.4 feet
- J = Perception-reaction time (3 seconds)

Adjustments for longer vehicle lengths, slower acceleration capabilities, multiple tracks, skewed crossings, and other than flat highway grades are necessary. The formulas in this section may be used with proper adjustments to the appropriate dimensional values. It would be desirable that sight distances permit operation at the legal approach speed for highways, however, this is often impractical.

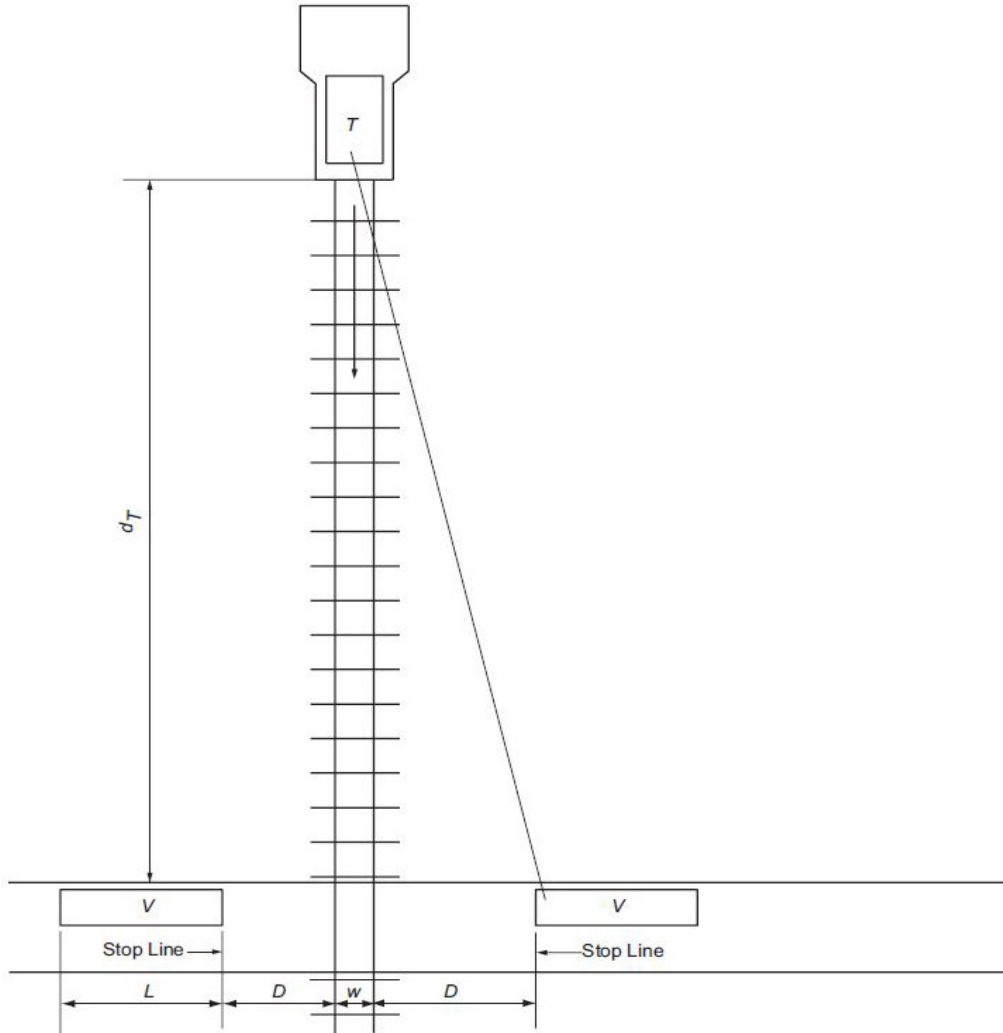

Figure C-5. Sight Distance for Stopped Vehicle

Source: American Association of State Highway and Transportation Officials (AASHTO): A Policy on Geometric Design of Highways and Streets, 7th Edition, (Figure 9-68), Washington DC, 2018.

Pedestrian Sight Distance Triangle

Evaluation of clearing sight distance at a pedestrian crossing should consider the pedestrian walking speed, the maximum authorized speed of trains at the crossing, as well as a decision/reaction distance and buffer zone (refer to **Figure C-6**).

Table C-2 provides computed values for both pedestrians as well as typical highway vehicles. The pedestrian sight distance, which is shown in the right-hand column, is based upon the following quantities: walking speed of 3.5 feet per second, 10 feet for decision/reaction distance (about 2.8 seconds), 15-foot track centers, a dynamic envelope of 11 feet, and a 6-foot buffer zone. In this example, the pedestrian will traverse the 42-foot distance in 12 seconds. The required sight distance is then computed by considering the distance the train will traverse in 12 seconds based upon the approach speed. At crossings where this distance is not available, active control devices should be considered. It should be noted that crossing users cannot be expected to reliably judge the precise approach speed of a train, so practitioners should consider that the required distances represent an absolute minimum.

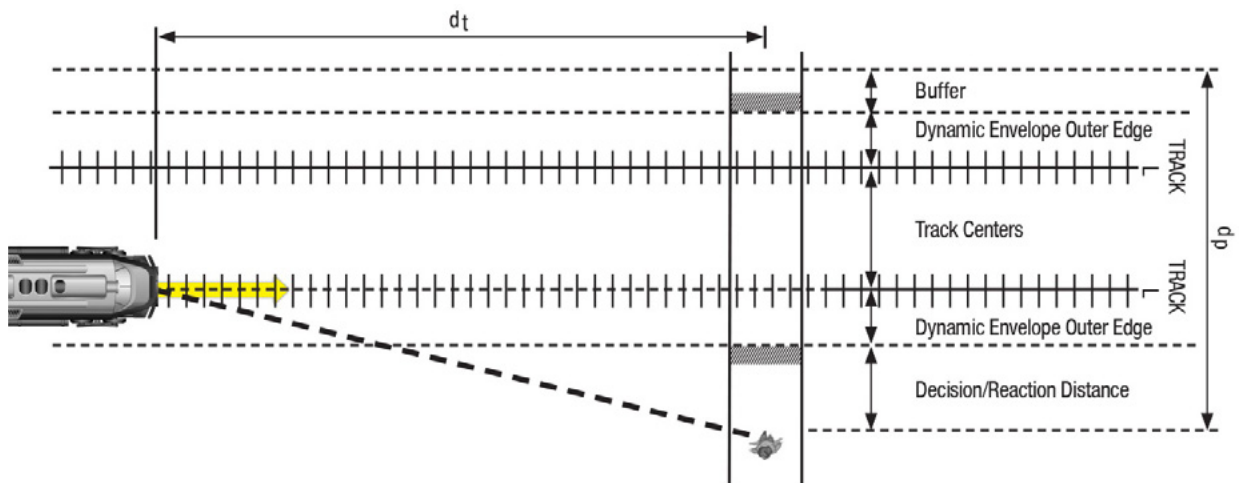

Figure C-6. Pedestrian Sight Distance Triangle (Double Track Crossing)

Source: Institute of Transportation Engineers.

Table C-2. Clearing Sight Distances (in Feet)

Train Speed^a	Car^a	Single-unit Truck^a	Bus^a	WB-50 Semitruck^a	65-foot Double Truck^a	Pedestrian^b
10	105	185	200	225	240	180
20	205	365	400	450	485	355
25	255	455	500	560	605	440
30	310	550	600	675	725	530
40	410	730	795	895	965	705
50	515	910	995	1,120	1,205	880
60	615	1,095	1,195	1,345	1,445	1,060
70	715	1,275	1,395	1,570	1,680	1,235
80	820	1,460	1,590	1,790	1,925	1,410
90	920	1,640	1,790	2,015	2,165	1,585

^a A single track, 90-degree, level crossing.

^b Walking 3.5 feet per second across two sets of tracks 15 feet apart, with a 2-second reaction time to reach a decision point 10 feet before the center of the first track, and clearing 10 feet beyond the centerline of the second track. Two tracks may be more common in commuter station areas where pedestrians are found.

Source: *Guidance on Traffic Control Devices at Highway-Rail Grade Crossings*. Washington, DC: Federal Highway Administration, Highway/Rail Grade Crossing Technical Working Group, November 2002.

Corridor Approach

The procedures for evaluating highway-rail grade crossings are generally based upon the physical and operational characteristics of individual crossings. A typical crossing safety program consists of several individual crossing projects. Funding for crossing safety is approved based on the requirements of these individual projects. Therefore, crossing evaluation, programming, and construction follow traditional highway project implementation procedures.

The corridor approach may be applied to an urban area, city, or community. In this case, all public crossings within the jurisdiction of a public agency are evaluated and programmed for improvements. The desired outcome is a combination of engineering improvements and closures such that both safety and operations are highly improved.

A corridor approach developed for crossings in a specified community or political subdivision provides for a comprehensive analysis of highway traffic operations. Thus, unnecessary crossings can be closed, and improvements can be made at other crossings. This approach enhances the acceptability of crossing closures by local officials and citizens.

Initially, all crossings in the system, both public and private, should be identified and classified by jurisdictional responsibility (for example, city, county, and State for public crossings; parties to the agreement for private crossings). This also includes crossings with train speeds from 80–110 mph. Information should be gathered on highway traffic patterns, train operations, emergency access needs, land uses, and growth trends. Inventory records for the crossings should be updated to reflect current operational and physical characteristics. A Diagnostic Team consisting of representatives from all public agencies having jurisdiction over the identified crossings and the railroads operating over the crossings should make an on-site assessment of each crossing (as described in the previous section). The Diagnostic Team’s recommendations should consider, among other things, crossing closure, installation of traffic control devices, upgrading existing traffic control devices, crossing elimination by grade separation, surface improvements, and improvements in train detection circuits. For railroad crossing locations interconnected to the traffic signaling system, appropriate timing should be re-evaluated to determine whether simultaneous or advanced preemption is suitable. The use of pre-signals and queue-cutter signals should also be explored, where warranted, to assist the preemption phasing to safely clear vehicles off the track prior to the activation of the railroad flasher lights and gates.

Federal, State, and local crossing funding programs should be reviewed to identify the eligibility of each crossing improvement for public funding. Other funding sources including railroads, urban renewal funds, land development funds, and other public or private funding sources should also be explored.

There are several advantages of the corridor approach. A group of crossings may be improved more efficiently through the procurement of materials and equipment in quantity, thus reducing product procurement and transportation costs. Usually, only one agreement between the State, local jurisdiction, and railroad is necessary for all the improvements. Train detection circuits may be designed as a part of the total railroad signal system rather than custom designed for each individual crossing. Electronic components, relay houses, and signal transmission equipment may be more efficiently utilized. Labor costs may be significantly reduced and travel time of construction crews may be reduced when projects are near each other.

If a crossing consolidation is contemplated, the effects on traffic circulation and the impact on the operation of adjacent intersections should be considered. Frequently, the consolidation of crossings also leads to the consolidation of traffic on other facilities and may permit the construction of a traffic signal at a nearby intersection or other improvements that could not be justified otherwise. In light of these and other potential impacts, communication with first responders on any changes with crossings should be considered a priority.

Railroads benefit from the application of the systems approach in several ways. Train speeds may be increased due to safety improvements at crossings. Maintenance costs may be reduced if enough crossings are closed. Other improvements may enhance the efficiency of rail operations.

Safety improvements are an obvious benefit to the public. Other benefits include reduced vehicular delays and better access for emergency vehicles.

The traffic study should also consider the impacts of crossing operations on the community. Considerations include frequency and length of train operations, pedestrian and bicycle access, and the need for crossings to provide adequate access to schools and services.

Standard data collection procedures can be found in several sources, including the *Highway Safety Engineering Studies Procedural Guide* or the *Manual of Transportation Engineering Studies* from the Institute of Transportation Engineers.^(100, 102)

D. APPENDIX—DIAGNOSTIC TEAM CROSSING EVALUATION REPORTING EXAMPLES FROM STATES

This appendix provides two example forms. The first shown in **Figure D-1** is an example of a Diagnostic Team Crossing Evaluation Report, Preliminary Document from the Texas Department of Transportation. The second is a link to an example of a Railroad Safety Diagnostic Team Crossing Evaluation Report Review Form for Quiet Zones from the State of Nevada Department of Transportation.

- [State of Texas Department of Transportation Review Form \(Figure D-1\)](#)
- [State of Nevada Department of Transportation Diagnostic Review Form](#)

**PRELIMINARY DOCUMENT
NOT FOR RELEASE PURSUANT TO 23 U.S.C. SECTION 409**

OFFICE USE ONLY

MINIMUM WARNING TIME
20 seconds Minimum Time (MT)
seconds Clearance Time (CT)
seconds Minimum Warning Time (MWT)
seconds Buffer Time (BT)
seconds Equipment Response Time (ERT)
seconds Advance Traffic Signal Preemption Time (APT)
seconds TOTAL APPROACH TIME

_____ Average Daily Traffic (ADT)
_____ Special Vehicle moves
_____ MPH
_____ through trains at _____ mph per day
_____ switch moves at _____ mph per day

Salvaged equipment: YES NO

Total estimated cubic yards of fill material:

- This project is actual cost for reimbursement of payment to the Railroad Company as agreed to by:
 This project is lump sum cost for reimbursement of payment to the Railroad Company as agreed to by:

TxDOT: _____ Railroad Company: _____

- Existing cross bucks meet TMUTCD guidelines
 Existing cross bucks do not meet TMUTCD guidelines and need to be replaced repaired. If replacement or repair is needed the railroad company or its contractor will make necessary arrangements, within 30 days of diagnostic
Notify TRF/RR when discrepancies are correct
- RxR pavement markings are to be installed, per the guidelines in the TMUTCD
 No RxR pavement markings are to be installed because
 Stop bars are to be installed, per the guidelines in the TMUTCD
 No stop bars are to be installed because
- Side lights are to be installed at this location. (Crossing is 50 feet or less from the parallel roadway)
 No side lights will be installed at this location. (Crossing is greater than 50 feet from the parallel roadway)
- AC power service is available at this location
 AC power service is not available at this location
- A signalized intersection is located _____ ft from crossing. Distance measured from the warning device to the edge of road/shoulder.
Attach copy of the preemption form
 No signalized intersection at this location
- Letter to proceed with project development was given to the Railroad Company
 No letter to proceed with project development was given to the Railroad Company because
- No yield or stop signs are to be installed by the State because
 Yield signs were recommended by the diagnostic team on an interim basis, per the guidelines in the TMUTCD. The local road authority was notified at Diagnostic. will be notified in writing. Yield signs to be installed within 30 days of diagnostic.
Notify TRF/RR when signs are installed
- Stop signs were recommended by the diagnostic team on an interim basis, per the guidelines in the TMUTCD. The local road authority was notified at Diagnostic. will be notified in writing. Stop signs to be installed within 30 days of diagnostic.
Notify TRF/RR when signs are installed
- Memo to install signs given to the district

DIAGNOSTIC TEAM

PROJECT INFORMATION

COUNTY: _____
 DOT No.: _____
 CONTROL: _____
 PROJECT: _____
 LOCATION: _____

RAILROAD: _____
 MILEPOST: _____

Date of Inspection: _____
 Date Layout Due: _____

**PRELIMINARY DOCUMENT
NOT FOR RELEASE PURSUANT TO 23 U.S.C. SECTION 409**

GENERAL NOTES

1. Signal circuits are designed to give 20 seconds Minimum Warning Time prior to the arrival of the fastest train at this crossing. Refer to signal circuit layout for total approach time.
2. **Constant warning** **Phase motion** **C Style /AC-DC** _____ circuits are to be used at this location. Upgrades required; _____ for circuit compatibility.
3. Conduit, fill dirt and crushed cover rock to be furnished in place by the Railroad Company or its Contractor at state's expense.
4. The Railroad Company or its Contractor will remove the existing **cross bucks** **mast flashers** **cantilevers** and dispose of the foundations.
5. The State or its Contractor will furnish and install or replace the appropriate pavement markings as outlined on the attached layout and standard sheet and in accordance with the guidelines in the Texas Manual on Uniform Traffic Control Devices.
6. The State or its Contractor will furnish and install or replace the following signs in accordance with the guidelines in the Texas Manual on Uniform Traffic Control Devices (TMUTCD) and the Standard Highway Sign Designs Manual for Texas(SHSD): _____ ea.(W10-1), _____ ea.(W10-2), _____ ea.(W10-3), _____ ea.(W10-4), _____ ea.(R15-4). Additional signs to be added. _____
7. The **State** **County** **City** agrees to maintain the pavement markings and advance warning signs placed along the roadways under their jurisdiction in accordance with the guidelines in the Texas Manual on Uniform Traffic Control Devices and as shown on the layout and standard sheets as acknowledged on the Title Sheet.
8. The Railroad Company or its Contractor shall furnish, install and maintain sign mounting brackets for the report sign (R15-4) at the States expense.
9. The Railroad Company or its Contractor shall stencil the DOT-AAR numbers on the signal masts facing the adjacent roadway in 2" black lettering.
10. The **State** **County** **City** agrees to trim and maintain trees and vegetation for adequate visibility of the crossing signals and advance warning signs as acknowledged on the Title Sheet.
11. The Railroad Company or its Contractor will provide traffic control in accordance with the guidelines in the Texas Manual on Uniform Traffic Control Devices.
12. The **State** **Railroad Company** or its Contractor will install metal beam guard fence as shown on the layout, at the **State's** **Railroads** expense.
13. The **State** **Railroad Company** or its Contractor will install retaining wall as shown on the layout, at the **State's** **Railroads** expense.
14. The Railroad or its Contractor will furnish and install a relay to provide **simultaneous** **advance preemption** to **existing traffic signal** **proposed traffic signal** **advance flasher**. Normally a closed circuit is required between the control relay of the grade crossing warning device and the traffic signal controller or flasher as stated in the Texas Manual on Uniform Traffic Control Devices.



W10-1



W10-2



W10-3

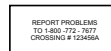

R15-4



R15-2



R8-8

ADDITIONAL NOTES

DESCRIPTION OF PROJECT

_____ Complete gate assemblies with _____ gate arm
 _____ Complete cantilever assemblies with _____ foot arm
 _____ Ea. R15-2, (_____ Tracks)

12" lamp housing shall be used and equipped with LED's (light emitting diodes), operated at not less than 8.5 volts under normal operating conditions.

Source: Texas Department of Transportation.

Figure D-1. State of Texas Department of Transportation Diagnostic Review Form

**E. APPENDIX—PREEMPTION CALCULATION PROCEDURES,
EXAMPLE FROM STATE OF TEXAS**

The following pages are the forms used by Texas DOT for preemption calculation procedures.

RESET

Form 2304
(Rev. 7/17)



Texas Department of Transportation
GUIDE FOR DETERMINING TIME REQUIREMENTS FOR
TRAFFIC SIGNAL PREEMPTION AT HIGHWAY-RAIL GRADE CROSSINGS

City CSJ Date
 County Completed by
 District District Approval

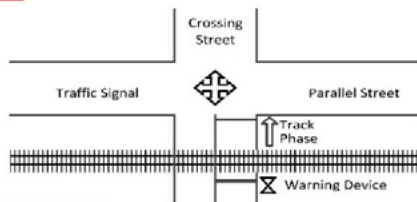

Parallel Street Name
 Crossing Street Name

Railroad Railroad Contact
 Crossing DOT# Phone

NOTE: After approval by the District, a copy of this form, along with the traffic signal design sheets and the phasing diagrams for normal and preempted operation, shall be placed in the traffic signal cabinet. See Section 7 for traffic signal timings.

SECTION 1: GEOMETRY DATA & DEFAULTS

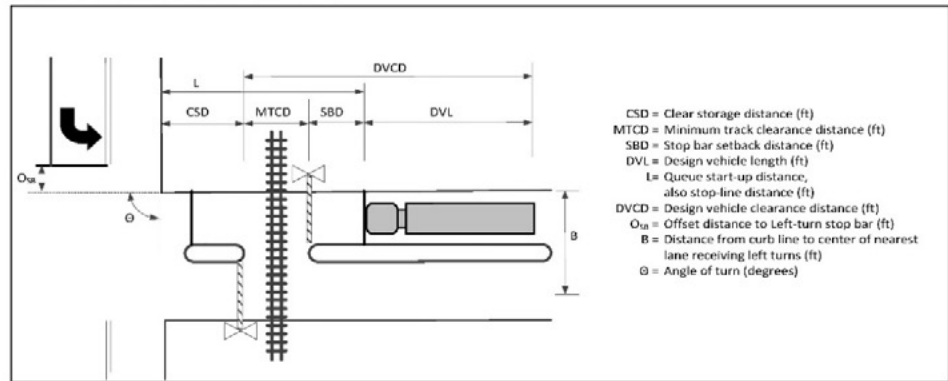

GEOMETRIC DATA FOR CROSSING

1. Clear storage distance (CSD, feet)	1.	<input type="text" value="0"/>
2. Minimum track clearance distance (MTCD, feet)	2.	<input type="text" value="0"/>
3. Stop bar setback distance (SBD, feet)	3.	<input type="text" value="8"/>
4. Width of receiving approach (B, feet)	4.	<input type="text" value="0"/>
5. Offset distance of left turn stop bar (O _{sa} , feet)	5.	<input type="text" value="0"/>
6. Approach grade. % (0 if approach is on downgrade)	6.	<input type="text" value="0.0"/>
7. Angle of turn at Intersection (θ, degrees)	7.	<input type="text" value="90"/>

Remarks

Enter "0" if no stop bar is present

DESIGN VEHICLE DATA

8. Select Design Vehicle
 School Bus Intermediate Truck Interstate Semi-Truck Other

9. Default design vehicle length (feet)	9.	<input type="text" value="75"/>	Based on selected Design Vehicle
a. Additional vehicle length, if needed (feet)	9a.	<input type="text" value="0"/>	Use only if "Other" selected as Design Vehicle
10. Total design vehicle length (DVL, feet)	10.	<input type="text" value="75"/>	Sum of line 9 and 9a
11. Centerline turning radius of design vehicle (R, feet)	11.	<input type="text" value="41"/>	Based on selected Design Vehicle
12. Passenger car vehicle length (LV, feet)	12.	<input type="text" value="19"/>	Default value

SECTION 2: RIGHT-OF-WAY TRANSFER TIME CALCULATION

Preempt verification and response time

13. Preempt delay time (seconds)	13.	<input type="text" value="0"/>	Remarks _____ Manufacturer: _____ Firmware Version: _____
14. Controller response time to preempt (seconds)	14.	<input type="text" value="0.0"/>	
15. Preempt verification and response time (seconds): add lines 13 and 14	15.	<input type="text" value="0.0"/>	

Worst-case conflicting vehicle time

16. Minimum green time during right-of-way transfer (seconds)	16.	<input type="text" value="5"/>	Remarks Value may be adjusted to meet local conditions _____ _____ _____
17. Other green time during right-of-way transfer (seconds)	17.	<input type="text" value="0"/>	
18. Yellow change time (seconds)	18.	<input type="text" value="0.0"/>	
19. Red clearance time (seconds)	19.	<input type="text" value="0.0"/>	
20. Worst-case conflicting vehicle time (seconds): add lines 16 through 19	20.	<input type="text" value="5.0"/>	

Worst-case conflicting pedestrian time

21. Minimum walk time during right-of-way transfer (seconds)	21.	<input type="text" value="0"/>	Remarks Value may be adjusted to meet local conditions _____ Refer to instructions for pedestrian truncation guidance _____
22. Pedestrian clearance time during right-of-way transfer (seconds)	22.	<input type="text" value="0"/>	
23. Vehicle yellow change time, if not included on line 22 (seconds)	23.	<input type="text" value="0.0"/>	
24. Vehicle red clearance time, if not included on line 22 (seconds)	24.	<input type="text" value="0.0"/>	
25. Worst-case conflicting pedestrian time (seconds): add lines 21 through 24	25.	<input type="text" value="0.0"/>	

Worst-case conflicting vehicle or conflicting pedestrian time

26. Worst-case conflicting vehicle or conflicting pedestrian time (seconds): maximum of lines 20 and 25	26.	<input type="text" value="5.0"/>	
27. Right-of-way transfer time (seconds): add lines 15 and 26	27.	<input type="text" value="5.0"/>	

SECTION 3: QUEUE CLEARANCE TIME CALCULATION

28. Are there left-turns towards the tracks? <input type="checkbox"/> Yes <input checked="" type="checkbox"/> No			Remarks _____ LTL = $\lceil TR6/180 \rceil$ _____ Default value Equation: $(\text{line } 4 + \text{line } 5 + \text{line } 12 - \text{line } 11) + \text{line } 29 + \text{line } 10$ _____ Equation: $(\text{line } 31 * 3600) / (\text{line } 30 * 5280) - \text{line } 18 - \text{line } 19$ _____
29. Distance traveled by truck during left-turn (LTL, feet):	29.	<input type="text" value="0"/>	
30. Travel speed of left-turning truck (S _{LTT} , mph):	30.	<input type="text" value="10"/>	
31. Distance required to clear left-turning truck from travel lanes on track clearance approach (feet):	31.	<input type="text" value="0"/>	
32. Additional time required to clear left-turning truck from travel lanes on track clearance approach (seconds):	32.	<input type="text" value="0.0"/>	
33. Worst-case Left Turning Truck time (seconds): if Line 28 = 'Yes', use line 32; otherwise Use 0	33.	<input type="text" value="0.0"/>	
34. Queue start-up distance, L (feet): add lines 1 through 3	34.	<input type="text" value="8"/>	
35. Time required for design vehicle to start moving (seconds): calculate as $2+(L*20)$	35.	<input type="text" value="2.4"/>	
36. Design vehicle clearance distance, DVCD (feet): add lines 2, 3 and 10.....	36.	<input type="text" value="83"/>	
37. Time for design vehicle to accelerate through the DVCD (seconds), level terrain	37.	<input type="text" value="12.1"/>	
38. Factor to account for slower acceleration on uphill grade	38.	<input type="text" value="1.00"/>	
39. Time for design vehicle to accelerate through DVCD (seconds), adjusted for grade: multiply lines 37 and 38	39.	<input type="text" value="12.1"/>	
40. Queue clearance time (seconds): add lines 33, 35 and 39	40.	<input type="text" value="14.5"/>	

SECTION 4: MAXIMUM PREEMPTION TIME CALCULATION

41. Right-of-way transfer time (seconds): line 27	41.	<input type="text" value="5.0"/>	Remarks _____ Typical Value _____
42. Queue clearance time (seconds): line 40	42.	<input type="text" value="14.5"/>	
43. Desired minimum separation time (seconds)	43.	<input type="text" value="4.0"/>	
44. Maximum preemption time for Queue Clearance (seconds): add lines 41 through 43	44.	<input type="text" value="23.5"/>	

SECTION 5: SUFFICIENT WARNING TIME CHECK

		<u>Remarks</u>
45. Required minimum time, MT (seconds): per regulations	45. <input type="text" value="20"/>	_____
46. Clearance time, CT (seconds): (line 2 -35) / 10 (rounded up to nearest second).....	46. <input type="text" value="0"/>	_____
47. Total minimum warning time, MWT, needed (seconds): add lines 45 and 46 (excludes buffer time and equipment response time).....	47. <input type="text" value="20"/>	_____
48. Required advance preemption time (APT) from railroad (seconds): subtract line 47 from line 44, round up to nearest full second, enter 0 if less than 0	48. <input type="text" value="4"/>	_____
49. APT currently provided by railroad (seconds): Enter "0" if new crossing or signal	49. <input type="text" value="0"/>	_____

If the required advance preemption time (line 48) is greater than the amount of advance preemption time currently provided by the railroad (line 49), additional warning time must be requested from the railroad. Alternatively, the maximum preemption time (line 48) may be decreased after performing an engineering study to investigate the possibility of reducing the values on lines 13, 16, 17, 21, 22 and 43.

Remarks:

SECTION 6: TRACK CLEARANCE GREEN TIME CALCULATION (IF NO GATE DOWN CIRCUIT PROVIDED)

Preempt Trap Check

		<u>Remarks</u>
50. Warning Time Variability (Select One)		
<input type="checkbox"/> Consistent Warning Times	<input checked="" type="checkbox"/> Low Warning Time Variability	<input type="checkbox"/> High Warning Time Variability
51. APT required or provided (seconds): maximum of Line 48 or Line 49.....	51. <input type="text" value="4"/>	See Instructions for details.
52. Multiplier for maximum APT due to train handling	52. <input type="text" value="1.25"/>	_____
53. Maximum APT (seconds): multiply line 51 and 52	53. <input type="text" value="5.0"/>	_____
54. Minimum duration for the track clearance green interval (seconds)	54. <input type="text" value="15"/>	_____
55. Track Clearance Green Time to avoid Preempt Trap (seconds): add lines 53 and 54	55. <input type="text" value="20.0"/>	_____

Clearing of Clear Storage Distance

56. Time waiting on left-turn truck (seconds): line 33	56. <input type="text" value="0.0"/>	_____
57. Time required for design vehicle to start moving (seconds): line 35	57. <input type="text" value="2.4"/>	_____
58. Design vehicle clearance distance (DVCD, feet): line 36	58. <input type="text" value="83"/>	_____

If CSD ≤ DVL, you must clear the design vehicle through the entire CSD during the traffic clearance phase; however, if CSD > DVL, you should consider providing enough time to clear the design vehicle from the crossing.

Is the clear storage distance (CSD) less than or equal to the design vehicle length (DVL)?

- YES. The design vehicle MUST clear through the entire CSD. (CSD will be entered in Line 59).
- NO. The design vehicle may clear through a portion of the CSD.

Do you want to clear the design vehicle through the entire CSD?

- YES. Clear the entire CSD. (CSD will be entered in Line 59).
- NO. Clear the crossing ONLY. (DVL will be entered in Line 59).

59. Portion of CSD to clear during track clearance phase (feet)	59. <input type="text" value="0"/>	_____
60. Design vehicle relocation distance (DVRD, feet): add lines 58 and 59	60. <input type="text" value="83"/>	_____
61. Time required to accelerate design vehicle through DVRD (seconds), level terrain:	61. <input type="text" value="12.1"/>	_____
62. Factor to account for slower acceleration on uphill grade	62. <input type="text" value="1.00"/>	_____
63. Time required to accelerate design vehicle through DVRD (seconds), adjusted for grade: multiply lines 61 and 62	63. <input type="text" value="12.1"/>	_____
64. Time to clear portion of clear storage distance (seconds): add lines 56, 57 and 63	64. <input type="text" value="14.5"/>	_____
65. Track clearance green interval (seconds): maximum of lines 55 or 64, round up to nearest full second	65. <input type="text" value="20"/>	_____

Maximum Duration of Track Clearance Green after gates are down (in absence of a gate down circuit)

66. Total time to complete track clearance green (seconds): line 27 + line 65	66. <input type="text" value="25.0"/>	_____
67. Total time before gates are down (seconds): subtract 5 seconds from line 44 (per AREMA Manual)	67. <input type="text" value="18.5"/>	_____
68. Maximum Duration of Track Clearance Green after gates are down (seconds): Line 66 - Line 67	68. <input type="text" value="7"/>	_____

SECTION 7: SUMMARY OF CONTROLLER PREEMPTION SETTINGS

		<u>Remarks</u>
69. Duration Time (seconds)	69. <input type="text" value="0"/>	Default Value
70. Preempt Delay Time (seconds)	70. <input type="text" value="0"/>	From Line 13
<u>Right of Way Transfer Phase</u>		
Remarks		
71. Minimum Green Interval (seconds)	71. <input type="text" value="5"/>	From Line 16
72. Pedestrian Walk Interval (seconds)	72. <input type="text" value="0"/>	From Line 21
73. Pedestrian Clearance Interval (Flashing "DON'T WALK", seconds)	73. <input type="text" value="0"/>	From Line 22
74. Yellow Change Interval (seconds)	74. <input type="text" value="0.0"/>	From Line 18
75. All Red Vehicle Clearance (seconds)	75. <input type="text" value="0.0"/>	From Line 19
<u>Track Clearance Phase</u>		
Remarks		
76. Green Interval (seconds) (in the absence of gate down circuit)	76. <input type="text" value="20"/>	From Line 65
77. Green Interval (seconds) <u>with</u> gate down circuit	77. <input type="text" value="15"/>	From Line 40
78. Yellow Change Interval (seconds)	78. <input type="text" value="0.0"/>	From Line 18
79. All Red Vehicle Clearance (seconds)	79. <input type="text" value="0.0"/>	From Line 19
<u>Exit Phase</u>		
Remarks		
80. Dwell/Cycle Minimum Green Time (seconds)	80. <input type="text" value="0"/>	Default Value
81. Yellow Change Interval (seconds)	81. <input type="text" value="0.0"/>	From Line 18
82. All Red Vehicle Clearance (seconds)	82. <input type="text" value="0.0"/>	From Line 19

Remarks:

Figure E-1. Texas DOT—Guide for Determining Time Requirements for Traffic Signal Preemption at Highway-Rail Grade Crossings

Please visit this website for the original forms:
<http://www.txdot.gov/txdotforms/GetForm?formName=/2304.pdf&appID=/TRF&status=/reportError.jsp&configFile=WFServletConfig.xml>

**Download a PDF file of Texas Department of Transportation—
 Guide for determining time requirements for traffic signal
 preemption at highway-rail grade crossings: [appeniform.pdf](#)**

To view PDF files, you can use the [Adobe® Reader®](#).

REFERENCES

1. *Manual on Uniform Traffic Control Devices*. (2009). Washington, DC: FHWA. <https://mutcd.fhwa.dot.gov/pdfs/2009r1r2/mutcd2009r1r2edition.pdf>, last accessed August 20, 2018.
2. Seyfried, R. K., P.E., PTOE (2013). *Traffic Control Devices Handbook (2nd Edition)*. Washington, DC: ITE.
3. *Proposed Recommended Practice for Preemption of Traffic Signals Near Railroad Crossings*. (2006, updated 2019). Washington, DC: ITE.
4. Benefit-Cost Analysis Guidance for Discretionary Grant Programs, Office of the Secretary, US DOT, Washington, DC 2018.
5. *49 CFR Part 222—Use of Locomotive Horns at Public Highway-Rail Grade Crossings*.
6. *23 CFR 625.4—Design Standards for Highways*. (Washington, DC, October 2018).
7. *Automatic Train Control and Advanced Civil Speed Enforcement System; Northeast Corridor Railroads*. (July 22, 1998). Washington, DC: Government Publishing Office (GPO). Retrieved from: <https://www.gpo.gov/fdsys/pkg/FR-1998-07-22/html/98-19431.htm>, last accessed August 18, 2018.
8. *Highway-Rail Grade Crossing Guidelines for High-Speed Passenger Rail (Version 1.0)*. (November 2009). Washington, DC, FRA, Office of Railroad Safety and Office of Railroad Development. Retrieved from: <https://www.fra.dot.gov/Elib/Document/15140>, Page 12–13, last accessed August 17, 2018.
9. *Uniform Vehicle Code, Millennium Edition*, National Committee on Uniform Traffic Laws and Ordinances (Washington, DC 2000). Retrieved from: <http://iamtraffic.org/wp-content/uploads/2013/01/UVC2000.pdf>, last accessed October 16, 2018.
10. *Research Results: Crossing Consolidation Guidelines, RR 09-12*. (July 2009). Washington, DC: FRA. Retrieved from: <https://www.fra.dot.gov/Elib/Document/2002>, last accessed August 20, 2018.
11. *2013 Compilation of State Laws and Regulations Affecting Highway-Rail Grade Crossings, Sixth Edition*. USDOT, FRA (Washington, DC, February 2013). Retrieved from: <http://www.fra.dot.gov/Elib/Document/3622>, last accessed, October 16, 2018.
12. *Highway Rail Crossing Elimination and Consolidation*, American Association of State Highway and Transportation Officials, Standing Committee on Rail Transportation, (Washington, DC, March 1995). Retrieved from: <https://trid.trb.org/view/573825>, last accessed October 16, 2018.
13. *Consolidating Railroad Crossings: On Track for Safety in North Carolina*. (2000). North Carolina: NCDOT, Rail Division, Engineering and Safety Branch. Retrieved from: <https://www.ncdot.gov/divisions/rail/Pages/safety-education.aspx>, last accessed August 20, 2018.

14. Korve Engineering, Inc. *San Gabriel Valley Grade Crossings Study*, San Gabriel Valley Council of Governments. (Pasadena, CA, January 1997).
15. Alameda-Corridor East Project website Alameda Corridor-East Construction Authority (n.d.). Last accessed August 24, 2018, from <http://www.theaceproject.org/>
16. *BNSF's Campaign to Improve Safety at Grade Crossings*. Progressive Railroading (New York, NY, January 2006). Retrieved from: https://www.progressiverailroading.com/bnsf_railway/article/BNSFs-campaign-to-improve-safety-at-grade-crossings--31830, last accessed October 6, 2018.
17. Accidents that Shouldn't Happen, A Report of the Grade Crossing Safety Task Force to Secretary Federico Pena, March 1, 1996. USDOT, Executive Summary.
18. Sobanjo, John O. (May 2006). *Design Guidelines for Highway Roadway Grade Crossing Profiles in Florida*, Florida State University, FL.
19. *Part III, Box 2E of the USDOT Crossing Inventory Form*. USDOT/FRA, Office of Railroad Safety. (Washington, DC, July 2016). Retrieved from <https://www.fra.dot.gov/eLib/Details/L16201>, last accessed August 20, 2018.
20. Federal Highway Administration, Safety website, Roadway Departure, Clear Zones. USDOT/FHWA (Washington, DC n.d.) Retrieved from: https://safety.fhwa.dot.gov/roadway_dept/countermeasures/safe_recovery/clear_zones, last accessed October 7, 2018.
21. *Illinois Administrative Code Title 92, Section 1535.205—right-of-way to be kept clear*. (December 2005). Des Plaines, IL: ICC. Retrieved from: <ftp://www.ilga.gov/jcar/admincode/092/092015350C02050R.html>, last accessed August 20, 2018.
22. *A Policy on Geometric Design of Highways and Streets, 7th Edition*. American Association of State Highway Transportation Officials. (Washington, DC, 2018).
23. *Roadside Design Guide, 4th Edition*, American Association of State and Highway Transportation Officials (Washington, DC, 2011).
24. *Manual for Assessing Safety Hardware, 2nd Edition*, American Association of State and Highway Transportation Officials (Washington, DC, 2016).
25. *Roadway Lighting*, American National Standards Institute/Illumination Engineering Society RP-8-14 (New York, NY, 2014).
26. *Manual for Railway Engineering*. (Current Edition 2018). Lanham, MD: AREMA. Retrieved from: http://www.arena.org/AREMA_MBRR/Store/MRE_TOC.aspx, last accessed August 20, 2018.
27. *Train and Truck Crash on Railroad Right-of-Way and Subsequent Fire*, National Transportation Safety Board Highway Accident Brief, Accident Number HWY15MH006 (Washington, DC, December 2016).

28. Richards, Stephen H., Heathington, K. W. (1990). Assessment of Warning Time Needs at Railroad-Highway Grade Crossings with Active Traffic Control, Washington, DC, TRB 1254.
29. *Communications & Signals Manual*, American Railway Engineering and Maintenance-of-Way Association (Lanham, MD, 2018.)
30. *Use of Traffic Channelizing Devices at Highway-Rail Grade Crossings*. Research Results RR 10-03, USDOT, FRA (Washington, DC, June 2010). Retrieved from <https://www.fra.dot.gov/Elib/Document/137>, last accessed October 17, 2018.
31. Korve, Hans W., Brent D. Ogden, Joaquin T. Siques, D. Mansel, et al. (2001). *Light Rail Service: Pedestrian and Vehicular Safety*, Transit Cooperative Research Program Report 69, National Academy Press. Washington, DC.
32. Appendix A to 49 CFR Part 211—*Statement of Agency Policy Concerning Waivers Related to Shared Use of Trackage or Rights-of-Way by Light Rail and Conventional Operations*.
33. *Light Rail Vehicle Collisions with Vehicles at Signalized Intersections*, Kelley Klaver Pecheux and Harry Saporta, Transit Cooperative Research Program Synthesis 79, (Washington, DC, 2009), Pg. 33.
34. Korve, Hans W., Jose I. Farran, Douglas M. Mansel, et al. (1996). *Integration of Light Rail Transit into City Streets*. Washington, DC: TRB Cooperative Research Program, Report 17 Retrieved from: <http://www.trb.org/Publications/Blurbs/153829.aspx>, last accessed August 21, 2018.
35. Americans with Disabilities Act website, (n.d.). Retrieved August 21, 2018 from: <https://www.ada.gov/>
36. Korve Engineering et al. *Audible Signals for Pedestrian Safety in LRT Environments*, Research Results Digest 84, Transportation Research Board (2007).
37. *Guidelines and Standards*. United States Access Board. (Washington, DC July 2011). Retrieved from <https://www.access-board.gov/guidelines-and-standards/>, last accessed October 18, 2018.
38. Detectable Warnings Update, United States Access Board. (Washington, DC) <https://www.access-board.gov/guidelines-and-standards/streets-sidewalks/public-rights-of-way/guidance-and-research/detectable-warnings-update>, last accessed October 17, 2018.
39. *Compilation of Pedestrian Safety Devices in Use at Grade Crossings*. USDOT/ FRA (Washington, DC, January 2008). Retrieved from <https://www.fra.dot.gov/Elib/Document/1370>, last accessed October 17, 2018.
40. *Guidance on Pedestrian Safety at or Near Passenger Stations*. USDOT/FRA. (Washington, DC, April 2012).
41. Gabree, S & Chase, Stephanie & daSilva, Marco. (2013). *Effect of Gate Skirts on Pedestrian Behavior at Highway-Rail Grade Crossings*. Washington, DC: FRA.

42. *Engineering Design for Pedestrian Safety at Highway-Rail Grade Crossings Report*. (2016). Cambridge, MA: Volpe National Transportation Systems Center.
43. *Highway Safety Benefit-Cost Analysis Guide*, FHWA-SA-18-001. USDOT/FHWA (February 2018).
44. *Highway Safety Benefit Cost Analysis Tool*, USDOT/FHWA (Washington, DC, n.d.). Retrieved from: https://safety.fhwa.dot.gov/hsip/docs/bcatool030118_finalv2.0.xlsm, last accessed October 17, 2018.
45. Farr, E. H. (1987). *Rail-Highway Crossing Resource Allocation Procedure, User's Guide, Third Edition*. Washington, DC: FRA, Office of Safety Analysis.
46. FRA Web Accident Prediction System. USDOT/FRA, Office of Safety Analysis. (Washington, DC, n.d.). Retrieved from <https://safetydata.fra.dot.gov/webaps/>, last accessed: October 17, 2018.
47. GradeDec.Net—System for Highway-Rail Grade Crossing Investment Analysis. USDOT/FRA (Washington, DC, n.d.). Retrieved from <https://gradedec.fra.dot.gov>, last accessed October 17, 2018.
48. *GradeDec Crossing Evaluation Tool Reference Manual* (FRA, 2014). Retrieved from: <https://www.fra.dot.gov.eLib/details/L03769>
49. *Highway Safety Improvement Program Manual*. (January 2010). Washington, DC: USDOT/FHWA. Retrieved from: <https://safety.fhwa.dot.gov/hsip/resources/fhwasa09029/>, last accessed August 20, 2018.
50. Data is available through 2017. Retrieved from: <https://www.gao.gov/assets/700/695372.pdf>
51. *Fixing America's Surface Transportation Act "Fast Act"* website USDOT/FHWA. (n.d.). Retrieved August 21, 2018, from <https://www.fhwa.dot.gov/fastact/factsheets/railwayhwycrossingsfst.cfm>
52. *23 CFR 646.210—Classification of Projects and Railroad Share of the Cost*. (2004). Washington, DC: FHWA. Retrieved from: <https://www.gpo.gov/fdsys/granule/CFR-2004-title23-vol1/CFR-2004-title23-vol1-sec646-210>, last accessed August 21, 2018.
53. *23 CFR 646.212 Federal Share*. (2004). Washington, DC: FHWA. Retrieved from: <https://www.gpo.gov/fdsys/granule/CFR-2004-title23-vol1/CFR-2004-title23-vol1-sec646-210>
54. *Strategies for Improving the Project Agreement Process Between Highway Agencies and Railroads*, (n.d.). Washington, DC: USDOT/FHWA. Retrieved from: https://www.fhwa.dot.gov/goshrp2/Solutions/Renewal/R16/RailroadDOT_Mitigation_Strategies, last accessed August 21, 2018. A download link to the full document is available at <http://www.trb.org/Publications/Blurbs/164283.aspx>

55. *Technical Bulletin S-12-0 1, Guidance Regarding the Appropriate Process for the Inspection of Highway-Rail Grade Crossing Warning System Pre-emption Interconnections Highway Traffic Signals*. (July 2012). Washington, DC: USDOT/FRA. Retrieved from: <http://ctcinc.com/wp-content/uploads/2013/06/FRA-TB-S-12-01-Pre-emption-Inspections.pdf>, last accessed August 21, 2018.
56. *Notice of Safety Advisory; Signal Recording Devices for Highway-Rail Grade Crossing Active Warning Systems that are Interconnected with Highway Traffic Signal Systems*, Safety Advisory 2010-02, USDOT, FRA, published in Federal Register Vol. 75, No. 190 (Washington, DC, October 1, 2010).
57. Moriarty, Kevin, Bendyk, Joshua, McGee, Hugh, Herr, Joseph, Byrne, Terry, and Dixon, Matthew. (October, 2012). *Recording Devices for Interconnected Grade Crossing and Intersection Signal Systems: An Informational Report*. Washington, DC: USDOT/FHWA. Retrieved from: https://safety.fhwa.dot.gov/hsip/xings/recording_device/, last accessed August 21, 2018.
58. Rutter, Allan, Morgan, Curtis, Warner Jeff, Graves, Brett. (November 2016). *Highway-Railway Grade Crossing Action Plan and Project Prioritization Noteworthy Practices Guide*. Washington, DC: FHWA. Retrieved from file:///D:/Data/Project/LDT_TPTO/097199005%20-%20US%20DOT%20GC%20Handbook/Technical/Background%20Information/16-0040L-HighwayRailCrossingPlan_22nov16_10.pdf, last accessed August 23, 2018.
59. 49 CFR 234.209—*Interference with Normal Functioning of System*.
60. *Frequently Asked Questions*, Surface Transportation Board website. Retrieved from: <https://www.stb.gov/stb/faqs.html>, last accessed October 17, 2018.
61. *Highway-Rail Grade Crossing Guidelines for High-Speed Passenger Rail (Version 1.0)*. (November 2009). Washington, DC: FRA, Office of Railroad Safety and Office of Railroad Development. Retrieved from: <https://www.fra.dot.gov/Elib/Document/15140>, Page 12–13, last accessed August 17, 2018.
62. *Intelligent Transportation System Architecture and Standards*. (n.d.). Washington, DC: USDOT/FHWA. Retrieved from: https://ops.fhwa.dot.gov/its_arch_imp/policy_1.htm, last accessed August 22, 2018.
63. *1570–2002—Standard for the Interface Between the Rail Subsystem and the Highway Subsystem at a Highway Rail Intersection*. (2003, Reaffirmed 2008). New York, NY: IEEE. Retrieved from: <https://www.standards.its.dot.gov/Factsheets/Factsheet/79>, last accessed August 22, 2018.
64. *Quiet Zone Calculator*, FRA website. Retrieved from <https://safetydata.fra.dot.gov/quiet/login.aspx>, last accessed October 17, 2018.
65. *Guide to the Quiet Zone Establishment Process*. (September 2013), Washington, DC: FRA. Retrieved from: <https://www.fra.dot.gov/Elib/Document/3403>, last accessed August 22, 2018.

66. *Safety & Security*, Chicago Transit Authority website. Retrieved from <https://www.transitchicago.com/safety/#Campaigns>, last accessed October 17, 2018.
67. *Riding Safety*, New York MTA website, retrieved from <http://web.mta.info/safety/>, last accessed October 17, 2018.
68. “Safetyville” Video Playlist, Los Angeles County Metro Metropolitan Transportation Authority, https://www.youtube.com/playlist?list=PLli3M8RkN4llxqA4WptrGLP4m7CX_r5Lc, last accessed October 18, 2018.
69. Police Coordinate Special Railroad Crossing Enforcement Operations. (n.d.). Stevens Point, WI: WSAW TV. Retrieved from: <http://www.wsaw.com/content/news/Police-coordinate-special-railroad-crossing-enforcement-operation--481523871.html>, last accessed August 22, 2018.
70. Sposato, S., Bien-Aime, P., & Chaudhary, M. *Safety of highway-rail grade crossings: Public education and enforcement Research study, Final Report* (Report No. DOT/FRA/ORD-06/27, DOT-VNTSC-FRA-06-03), (Cambridge, MA December 2006). Retrieved from: <https://www.fra.dot.gov/Elib/Document/121>, last accessed October 17, 2018.
71. *Railroad Facts*, 2017 Edition, page 47. Washington, DC: Association of American Railroads.
72. U.S. Highway Statistics, Travel Lane Miles. (June 29, 2018). Washington, DC: FHWA, Office of Highway Policy.
73. *Railroad Safety Statistics Preliminary Annual Report*, Table 9-2. (July 2015). Washington, DC: USDOT, FRA. Retrieved from: <https://www.bts.gov/content/highway-rail-grade-crossings-type>, last accessed August 22, 2018.
74. *Safety Data Statistic of Railroad Crossing Deaths, Injuries, & Incidents from 2008–2017*. (n.d.). Washington, DC: USDOT, FRA.
75. *Highway Crossing Accident/Incident and Inventory Bulletin (No.18 Calendar Year 1995). (1996)*. Washington, DC: FRA.
76. *Traffic Safety Facts 2015: A Compilation of Motor Vehicle Crash Data from the Fatality Analysis Reporting System and the General Estimates System*. (2015). Washington, DC: USDOT/NHTSA. Retrieved from: <https://crashstats.nhtsa.dot.gov/Api/Public/ViewPublication/812384>, last accessed August 22, 2018.
77. National Highway Traffic Safety Administration. website—(nd), Washington, DC. Retrieved August 22, 2018, from <https://www.nhtsa.gov/>
78. Accident/Incident Data Query. FRA.—(n.d.). Retrieved August 22, 2018, from <https://safetydata.fra.dot.gov/officeofsafety/publicsite/Query/CasualtiesReport.aspx>
79. *Surface Transportation Assistance Act of 1987, Public Law 100-17*, 101 Stat. 171.
80. *Fact Sheets on Highway Provisions, Highway Safety Improvement Program*. (n.d.). Washington, DC: FHWA. Retrieved from: www.fhwa.dot.gov/safetealu/factsheets/hsip.htm, last accessed August 22, 2018.

81. *23 U.S. Code § 130—Railway-highway crossings*. (January 2012). Retrieved from: <http://uscode.house.gov/view.xhtml?req=granuleid:USC-prelim-title23-section130&num=0&edition=prelim>, last accessed October 12, 2018.
82. *Chapter I—Highway Safety Part 924—Highway Safety Improvement Program, Section § 924.9—Planning*. (April 2016), Washington, DC: FHWA. Retrieved from: <https://www.gpo.gov/fdsys/search/pagedetails.action?sr=952&originalSearch=&st=fur&ps=10&na=&se=&sb=re&timeFrame=&dateBrowse=&govAuthBrowse=&collection=&historical=false&packageId=CFR-2016-title23-vol1&fromState=&bread=true&granuleId=CFR-2016-title23-vol1-sec924-9&collectionCode=CFR&browsePath=Title+23%2FChapter+I%2FSubchapter+J%2FPart+924%2FSection+%26sect%3B+924.9&collapse=true&fromBrowse=true>, last accessed August 22, 2018.
83. Fixing America’s Surface Transportation Act “Fast Act” website USDOT/FHWA. (n.d.). Retrieved August 21, 2018, from: <https://www.fhwa.dot.gov/fastact/factsheets/railwayhwycrossingsfst.cfm>
84. National Transportation Safety Board. NTSB Recommends Training, Operating Guidelines following Glendale, California Grade Crossing Accident. November 27, 2001. Accessed online: https://www.nts.gov/news/press-releases/Pages/NTSB_Recommends_Training_Operating_Guidelines_following_Glendale_California_Grade_Crossing_Accident.aspx
85. *Highway-Rail Crossing Surfaces*. Washington, DC: National Cooperative Highway Research Program Synthesis of Practice 250. (1997). Washington, DC: NCHRP.
86. *Uniform Vehicle Code and Model Traffic Ordinance*. (2005). Evanston, IL: National Committee on Uniform Traffic Laws and Ordinances, Evanston, IL. <http://iamtraffic.org/wp-content/uploads/2013/01/UVC2000.pdf>
87. *A Policy on Geometric Design of Highways and Streets, 7th Edition*. American Association of State Highway Transportation Officials. (Washington, DC, 2018).
88. United States, National Transportation Safety Board. *Railroad/Highway Grade Crossing Accidents Involving Trucks Transporting Bulk Hazardous Materials, A Special Study, Report NTSB-HZM-81-2*. (September 1981). Washington, DC: NTSB.
89. 49 CFR 229.125. *Headlights and Auxiliary Lights*.
90. *Research Results: Alerting Lights on Locomotives*. (July 2007). Washington, DC: USDOT/FRA. Retrieved from: <https://www.fra.dot.gov/Elib/Document/2098>, last accessed August 23, 2018.
91. 49 CFR Part 222.21—Subpart B—Use of Locomotive Horns. 49 CFR 229.129—Locomotive Horn.
92. 49 CFR 224. *Reflectorization of Rail Freight Rolling Stock*.

93. *Federal-Aid Policy Guide (FAPG) 23 CFR 924.3—Code of Federal Regulations (and Non-Regulatory Supplements)*. (2016). Washington, DC: FHWA. Retrieved from: <https://www.fhwa.dot.gov/legisregs/directives/fapgtoc.htm>, last accessed August 23, 2018.
94. 49 CFR Part 234, Subpart F—Highway-Rail and Pathway Crossing Inventory Reporting. (January 2015). Retrieved from: <https://www.govinfo.gov/app/details/CFR-2017-title49-vol4/CFR-2017-title49-vol4-part234-appB>, last accessed October 12, 2018.
95. Section § 390.5: Definitions (2017). Washington, DC: FMSCA. Retrieved from: <https://www.ecfr.gov/cgi-bin/retrieveECFR?gp=1&ty=HTML&h=L&mc=true&=PART&n=pt49.5.390>, last accessed August 23, 2018.
96. Sperry, B.R., B. Naik, and J.E. Warner. (2017). *Current Issues in Highway-Railroad Grade Crossing Hazard Ranking and Project Development*. Transportation Research Record: Journal of the Transportation Research Board, No. 2608, pp. 19–26, Washington, DC.
97. Sperry, B.R., B. Naik, and J.E. Warner. (May 2016). Evaluation of Grade Crossing Hazard Ranking Models. Report No. FHWA/OH-2016/10, Ohio University, Athens, OH.
98. Farr, E. H. (1987). *Rail-Highway Crossing Resource Allocation Procedure—User’s Guide, Third Edition*. Federal Railroad Administration, Report No. DOT/FRA/OS-87/10, Washington, DC.
99. GradeDec.Net Crossing Evaluation Tool Reference Manual. (2014). Washington, DC: FRA. Retrieved from: <https://www.fra.dot.gov/Elib/Document/14852>, last accessed August 23, 2018.
100. *Highway Safety Engineering Studies Procedural Guide*. (November 1991). Washington, DC: FHWA.
101. *A User’s Guide to Positive Guidance*. (June 1977). Washington, DC: FHWA, Office of Operations.
102. *Manual of Transportation Engineering Studies*. (1994). Washington, DC: Institute of Transportation Engineers (ITE).

FHWA-SA-18-040
FRA-RRS-18-001