

# The need for a Design Handbook

## The growth in trails

In 1994 Florida had 1081 kilometers (670 miles) of off-road multi-use trails that are used by bicyclists, skaters, and pedestrians for both transportation and recreation.<sup>1</sup> Because of their popularity, the number and miles of trails is growing rapidly.



The proposed South Dade Greenway Network will ultimately be a system of 10 interconnecting trails that total 313 km (194 mi) (256 km/159 mi are off-road). One hundred thirty-two kilometers (82 mi) are currently programmed for improvements, and the entire SDGN could be completed by 2005.<sup>2</sup>

The continuing increase in trails reflects Floridians' interest in outdoor recreation and growing participation in bicycling, walking, and skating as healthy, environmentally low impact, efficient, and fun ways to get around.

The growth in trails also reflects many people's enjoyment of physical separation from motorized traffic. Segregation allows trail users to avoid the pollution, noise, and intimidation they perceive from motor vehicles, and the potential for an injury-producing crash.

While trails do provide for segregation from motor vehicle traffic along most of their length, they inevitably intersect with roadways and driveways, resulting in varying levels of integration and thus conflict with motorized traffic. It is at junctions where the potential for serious crashes lies.

## Crashes and the difficult task of crossing a junction

Numerous studies have well established that roadway junctions are over represented locations for bicyclist- and pedestrian-motor vehicle crashes.

In a recent nationwide sample, it was found that 57 percent of pedestrian and 73 percent of bicyclist crashes occurred at junctions.<sup>3</sup> Another study examining police-reported bicycle-motor vehicle collisions covering a four-year period in Palo Alto, California found that 74 percent occurred at a junction.<sup>4</sup>

# The need for a Design Handbook

Considering the complexity of crossing a junction, it is no wonder that the majority of crashes occur here.

A person simply walking across the street faces many difficulties—gap selection, turning vehicles, uneven terrain, obstacles (e.g., bollards), and other trail users. Consider then the task of a novice in-line skater who also has to deal with the challenges of staying upright and stopping.

Because of the complexity of crossing an intersection and human limitations, the following problems on the part of trail users and motorists alike can readily arise and lead to crashes:

- ▶ errors in gap judgement;
- ▶ inattention;
- ▶ poor visual search;
- ▶ improper expectations;
- ▶ haste.

“Street crossing is a learned, socialized behavior which we now understand to be much more complex than many behavior modification advocates would have us believe.”<sup>5</sup>

Michael R. Hill

## The lack of guidelines

Quality resources are available concerning the *planning and construction* of trails, but few guidelines for trail-roadway intersection design are available. Publications typically lack specific detail regarding trail crossing arrangements, or are from foreign countries, thus raising questions regarding applicability to the U.S.

*Trail Intersection Design Guidelines* addresses the details associated with trail-roadway intersection design, and incorporates U.S. roadway design principles with domestic and international trail design standards. It is intended to be the most comprehensive resource to date specifically addressing trail junctions.

## Conclusions

Inevitably there will be a substantial increase in the number (and miles) of trails, trail-roadway and -driveway junctions, trail users, and in the *potential* number of trail user-motor vehicle conflicts and crashes. Therefore it is vital to have a manual that provides guidelines to assist in designing these trail junctions so that operations and safety are maximized, and the number of conflicts and crashes are minimized.

Due to the inherent conflict at junctions, the need for careful design is evident. Careful design is especially important at trail junctions because of the vulnerability of trail users and because of the variability in the characteristics of trail users who come

# The need for a Design Handbook

in all ages, sizes, and capabilities. Trail users are indeed a diverse “design” group which requires planners and engineers to pay special attention to the details of intersection design.

While completely eliminating all intersection problems is not always feasible, careful design can reduce the number of incidences and lessen the consequences when they do occur.

*Trail Intersection Design Guidelines* is the result of:

- ▶ a limited literature review of designs and standards currently in use abroad and in the U.S.;
- ▶ a theoretical view of an inherently safe road traffic system, resulting in principles for the safe design of trail-roadway intersections;
- ▶ observations at approximately 60 trail intersections throughout Florida, and detailed research involving approximately 60 hours of video recording conducted at a subset of 20 of these, all along the Pinellas Trail.

## Literature review

Elements of bicycle and pedestrian planning and intersection design from the following principle sources are imbedded throughout these design guidelines.



*Diverse trail users*

## Development of the *Handbook*

### European

*Main roads in Urban Areas; Bikes and Pedestrians*<sup>6</sup> from Finland, and *Sign Up for The Bike*<sup>7</sup> from The Netherlands offer significant detail on accommodating bicyclists both on and off road, including intersection design. Both contain a wealth of information that contributed greatly throughout this document. But these documents are too broad in scope to thoroughly cover all aspects of trail intersection design, and all lack a United States context.

A third document, *Making Ways for the Bicycle*,<sup>8</sup> was produced by Sustrans, a British civil engineering charity which designs and builds traffic-free routes for cyclists, walkers, and people with disabilities. This attractive 56-page design manual is principally concerned with building a trail, and devotes only two pages to intersection design.

### Canada

The *Technical Handbook of Bikeway Design*<sup>9</sup> was produced by a bicycle advocacy organization known as Velo Quebec in collaboration with the Ministry of Transport of Quebec and the Canadian International Development Agency. The handbook offers recommendations and guidelines in an effort to ensure that “all bicycle facilities created in the next decade will be built to the highest possible standards.”

### United States

*Project Task 16: Evaluation of Issues In Planning And Design of Bicycle Trail-Highway Crossing*<sup>10</sup> produced by the Pennsylvania Transportation Institute at The Pennsylvania State University for the Pennsylvania Department of Transportation was the only domestic resource of information that considered many of the critical issues of trail intersections such as sight distance, signs, and pavement markings. This excellent document, while detailed, does not deal with the full breadth of considerations including access control and refuge islands, for examples.

*Trails For The Twenty-first Century*,<sup>11</sup> and *Greenways: A Guide to Planning, Design, and Development*<sup>12</sup> are very attractive trail design publications that cover all aspects of building a trail in detail, but are light on road crossing specifics.

The “bibles” of roadway and bikeway design, the *Manual on Uniform Traffic Control Devices (MUTCD)*<sup>13</sup>, *Traffic Control Devices Handbook*,<sup>14</sup> *A Policy on Geometric Design of Highways and Streets*,<sup>15</sup> known as the AASHTO “Green Book,” and the *Guide for the Development of Bicycle Facilities*<sup>16</sup> are referred to throughout this document. *The Design and Safety of Pedestrian Facilities*,<sup>17</sup> a monograph prepared by the Institute of Transportation Engineers (ITE) technical council committee 5A-5, also provided valuable information.

## Development of the *Handbook*

Greenways, Inc., of Cary, North Carolina, is a planning and landscape architecture firm that specializes in the design of greenways, rail-trails, and urban bicycle and pedestrian systems. This organization produced an illustrated technical memorandum describing how six trails in the U.S. have dealt with roadway crossings.

### Theoretical view

Years of experience, trial and error, and research have led to the development of roadway design documents such as the *MUTCD* and the *Green Book*. While relatively few references are made specifically regarding bicyclists and pedestrians, these populations **are** a part of the traffic stream. Many of the elements contained in these documents that apply to the safe movement of motor vehicles may—with modification if necessary—be applied to the safe movement of non-motorized travelers. Chapter 2 contains a compilation of principles for safely enabling trail users to cross a roadway intersection. It is in part an outgrowth of standards for safely moving motorized traffic.

### New research

Approximately 60 trail-roadway and -driveway junctions were observed throughout Florida. Trails included the:

- ▶ St. Marks Trail in Tallahassee
- ▶ Depot Rail-Trail in Gainesville
- ▶ Cady Way and West Orange Trails in the Orlando area

- ▶ Pinellas Trail in the Clearwater/St. Petersburg area
- ▶ State Road 84 Bike Path in Fort Lauderdale
- ▶ M Path in Miami.

The observed junctions were as diversified as the geographic locations themselves. Crossings included 2-lane up to 8-lane roads of varying widths and geometric configurations, with a range of motor vehicle speeds and volumes. The trails varied widely in terms of design and usage, and crossed at various points (e.g., midblock vs. near a roadway intersection). Also evident was the broad range in the quality of the crossings. Indeed, the junctions varied from the hopelessly uncrossable to a “deluxe” signalized situation where there was a median refuge area, elaborate illuminated warning signs, and the trail user was given “hot” button immediate response priority (see page 3-16). In addition, a representative sample of 20 junctions along the Pinellas Trail was examined in detail. Each was filmed for approximately three hours, and depending on the situation, various measures such as crossing time, use of refuge, motor vehicle interactions, violations and others were gathered from the video recordings. The knowledge gained from this research is found throughout this design handbook.

## Development of the *Handbook*

### What the *Handbook* is and isn't.

Only standard at-grade crossings are covered in this document. For information on roundabouts and overpasses, see the *Florida Bicycle Facilities Planning and Design Manual*.<sup>18</sup>

This document is not intended to be the final word on trail intersection design. Rather, it is a beginning. Additional knowledge is very much needed. This manual provides guidelines, not absolutes. Ultimately, it is the designer who, through good engineering study for each particular circumstance, is responsible for the safe and efficient design of the intersection.

Many figures are used throughout the document. **It is important to note that the figures are typically used to depict a particular design component and do not show all elements of intersection design.**

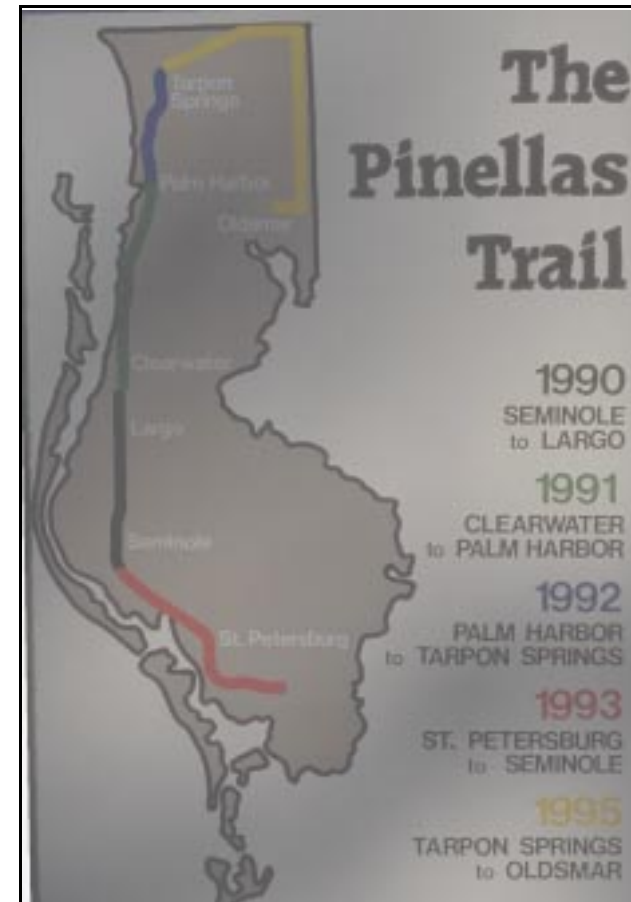

20 intersections of the Pinellas Trail were examined in detail.

# An elevated status

In both Finland and The Netherlands, non-motorized transportation is afforded high priority status. This is embodied throughout their respective planning practices to the extent that bicycle routes are well-developed and prevalent enough to be functionally classified similar to roadways. The Finns specify main, local, and recreational routes (Table 1), and the Dutch categorize through, distributor, and access routes.

Bicycle routes and pedestrian walkways are considered an integral part of the transportation system and are not merely amenities.

Two generalized standards from the Finns, who describe bicycle and pedestrian traffic as “light traffic,” demonstrate this philosophy:

- ▶ “arrangements are so clear that even those with little traffic sense (e.g., children) can use them properly;
- ▶ the alignment and conditions of a light-traffic route must be roughly the same standard as (or better than) the motor-vehicle road running along side it, to ensure the highest possible utilization rate.”

**Table 1.** Trail classification in Finland.

Trail Functional Classification	Function
Main Route	Links various parts of a built-up area together and serves primarily cycling that is either regional or long-distance between parts of the area.
Local Route	Carries internal light traffic in the town district or other suburban area, or between adjacent areas. Substantial pedestrian traffic.
Recreational Route	Serves outdoor recreation on foot, by bicycle, or on skis. Can form part of some other route network. Usually unpaved.

# An elevated status

The non-motorized infrastructure in The Netherlands is considered on two levels—the network and the individual facility—with respect to the five main requirements of:

- ▶ coherence
- ▶ directness
- ▶ attractiveness
- ▶ safety, and
- ▶ comfort.

Each of the five main requirements has a number of specific criteria which are then defined by one or more parameters (Table 2). For each parameter, to the extent possible, measurable limiting values are applied to the network and through, distributor, and access facility levels.

For example, “delay” is a criterion of the main requirement of directness. The defining parameter is “the average waiting time loss per kilometer,” and the limiting value on a through route is 15 seconds, 20 seconds on a distributor, and 20 seconds on an access bicycle route. A limiting value is not applicable on the network level.

While there are many important cultural, social, political, and geographical differences between these countries and the United States, we CAN aspire to rise to their level of planning for bicyclists and pedestrians. These unprotected and vulnerable transportation users deserve consideration equal to or greater than their motorized counterparts.

**Table 2.** The five main requirements and their criteria.

Coherence	Directness	Attractive-ness	Safety	Comfort
ease of finding	actual cycling speed	complaint pattern	traffic accident victims	smoothness
consistency of quality	delay	visibility	chance of confrontation with motor traffic	hilliness
freedom of route choice	detour distance	view	complexity of riding task	traffic obstruction
complete-ness		chance of blinding	pattern of complaint subjective safety	chance of stop
		social safety		impediment due to weather
		experience of surroundings		



## The design trail user

Trail-roadway intersections and driveway crossings must be engineered to accommodate “design” users. Who is a design trail user?

Trails can be expected to attract people of all ages, from very young children to the very elderly, with capabilities ranging from fast-moving bicyclists to the physically challenged. In other words, everybody uses trails.

Typical trail users may include bicyclists, walkers, runners, in-line skaters (rollerbladers), roller skaters, skateboarders, wheelchair users, baby strollers, dog walkers, and others.

Bicyclists have their own set of design user requirements as do foot travelers. The two populations at opposite ends of the age continuum—children and the elderly—are particularly at risk at trail junctions. Children (owing to their lack of traffic experience, impulsiveness, and small size) and the elderly (owing to their age-related physical limitations) present challenges to the designer. Finally, the junction (and trail itself) must also comply with Americans with Disabilities Act (ADA) mandated accessibility standards.



A well planned and designed trail will attract diverse users.

### Considering the needs of bicyclists

The bicycle is a single-track, human-powered vehicle of light weight, small size, and great maneuverability. The bicyclist operates under varying levels of physical and mental stress and is vulnerable to environmental elements and risk of injury.

Adapted from the *Florida Bicycle Facilities Planning and Design Manual*, the following elements must be considered:

# The design trail user

## Stability

- ▶ bicycles derive stability from the angular momentum of spinning wheels—at low speed a bicycle is less stable and requires greater skill to maintain control;
- ▶ cross winds and motor vehicle wind blast negatively affect stability.

## Steering

- ▶ it takes about 1.5 seconds to set up for a turn;
- ▶ bicycles steer more slowly when loaded.

## Surface condition effects

- ▶ tires contact the ground with as little as two dimes of surface area;
- ▶ bicycles provide little shock absorption;
- ▶ loose materials and slick surfaces (steel, thermoplastic, paint, oil, moisture) can cause slippage;
- ▶ longitudinal seams of >0.5 cm and other surface irregularities impact control.

## Braking

- ▶ deceleration:
  - maximum . . . . . 5 m/s<sup>2</sup> (16 ft/s<sup>2</sup>)
  - typical . . . . . 1.2 - 2.5 m/s<sup>2</sup> (4 - 8 ft/s<sup>2</sup>)
- ▶ perception-reaction time 2.5 s;
- ▶ allow additional 1.0 - 3.0 seconds for surprised condition reaction time.

## Visibility

- ▶ viewing object height . . . . . 100 mm (3.9 inches)
- ▶ bicycles are very narrow relative to other vehicles;
- ▶ bicyclists' curbside position on the roadway places them out of motorists' expected viewing area;
- ▶ motorists tend to look for other motor vehicles to the exclusion of bicyclists which are much less numerous;
- ▶ bicycles are especially difficult to detect under low light conditions.

## Speeds

- ▶ level terrain:
  - design minimum . . . . . 32 km/h (20 mi/h)
  - 85th percentile . . . . . 22 km/h (13.6 mi/h)
- ▶ descending . . . . . 50 km/h (31 mi/h)
- ▶ ascending . . . . . 10 km/h (6.2 mi/h)
- ▶ crossing trail-roadway intersection from a stop:
  - mean . . . . . 12.7 km/h (7.9 mi/h)
  - 15th percentile . . . . . 10.8 km/h (6.7 mi/h)
- ▶ acceleration at trail-roadway intersection from a stop:
  - mean . . . . . 1.07 m/s<sup>2</sup> (3.5 ft/s<sup>2</sup>)
  - 15th percentile . . . . . 0.74 m/s<sup>2</sup> (2.4 ft/s<sup>2</sup>)

## Dimensions and operating space

- ▶ length . . . . . 1.8 m (5.9 ft)
- ▶ rail height . . . . . 1.4 m (4.6 ft)
- ▶ bollard spacing . . . . . 1.5 m (4.9 ft)

# The design trail user

Figure 1, adapted from the *Technical Handbook of Bikeway Design*, depicts other design bicyclist dimensions and operating space.

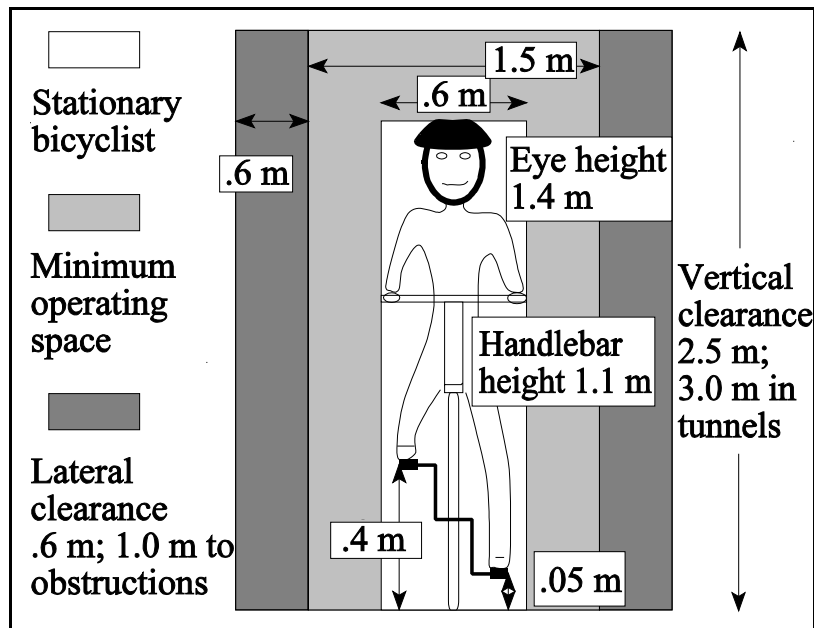

Figure 1. Design bicyclist dimensions. (1 m = 3.28 ft)

## Considering the needs of pedestrians

Figure 2, adapted from *Main Roads in Urban Areas, Bikes and Pedestrians*, depicts pedestrian design dimensions.

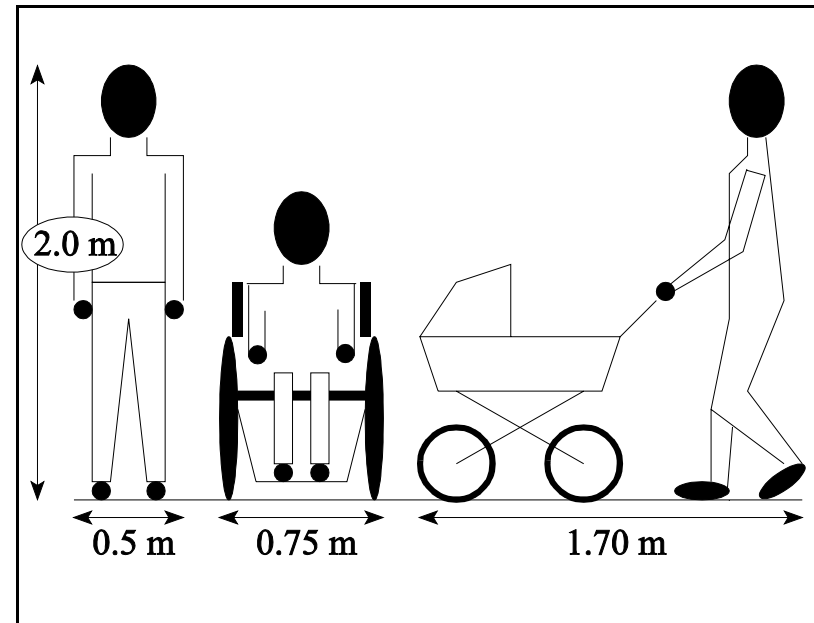

Figure 2. Design pedestrian dimensions. (1 m = 3.28 ft)

Walking speeds among pedestrians range from approximately 0.9 - 1.1 m/s (2.5 - 6.0 ft/s). Average walking speed is 1.2 m/s (4.0 ft/s) in accordance with the 1988 *MUTCD*, but 15 percent walk at or below 1.1 m/s (3.5 ft/s), and a recent study has assessed the walking speed of the elderly at 1.0 m/s (3.2 ft/s).<sup>19</sup>

## The design trail user

In areas where there are many elderly people, a rate of 0.9 m/s (3 ft/s) should be considered when designing facilities. A perception-reaction time of 3 seconds is appropriate.<sup>20</sup>

Walking rates are faster at midblock than at intersections, faster for men than women, and are affected by trip purpose, steep grades, time of day, weather conditions, ice, and snow.

### Considering the needs of skaters

Skaters may include in-line skaters (currently the country's fastest growing sport and the dominant category of skaters), rollerskaters, or skateboarders. While there are differences in operating characteristics among these three types of skater, they are similar enough to consider as one design category.

Similarly, according to the International In-Line Skating Association (IISA), "In-line skaters are enough like bicyclists that it makes sense to treat the two groups alike." There are important differences, however.

The small wheels of skates, typically 72-80 mm (2.8 - 3.1 in) diameter, makes skaters especially sensitive to surface debris and irregularities. In-line skaters require at least as much lateral clearance as bicyclists, and may use as much as 1.8 m (6 ft) of width operating space.

All in-line skates commercially available in the U.S. come with a heel drag brake mechanism, rollerskaters drag the toe, and skateboarders must drag the near end of the board. While

skater braking performance data do not exist, it seems likely that stopping ability is poorer than that of bicyclists, perhaps by 50 percent or more for novice skaters. The IISA recommends a flat section a minimum 9.1 m (30 ft) long in advance of intersections, and a 30 m (100 ft) sight line minimum to accommodate beginning skaters.

### Considering the needs of children

As compared with adults, children:

- ▶ have a lower profile in traffic;
- ▶ have a narrower visual field;
- ▶ cannot detect the direction of a sound as well nor isolate one sound;
- ▶ cannot judge closure speed as well;
- ▶ are overconfident;
- ▶ are restless with a desire for constant motion;
- ▶ once in motion are compelled to complete that motion;
- ▶ are fearless and poorly perceive risk;
- ▶ live in a self-centered world;
- ▶ assume adults will ensure their safety;
- ▶ do not understand complex situations;
- ▶ can only focus on one thought at a time;
- ▶ mix fantasy with reality.<sup>21</sup>

Young children find it difficult to comprehend that if their vision is blocked, they cannot see oncoming traffic and oncoming traffic cannot see them. Anyone who has played "hide-and-seek" with a young child has been amused that the child's idea of hiding may be simply to cover his or her eyes.

## The design trail user

Because of these characteristics, children perform poorly at gap assessment. Complicating this problem is children's propensity to engage in "follow the leader" type behavior, and their inherent lack of traffic experience. It is not surprising then that children are at great risk of a traffic crash.

Having created a world in which children are forced to negotiate the hazards of the road, we have the obligation to protect them from these hazards.

...the traffic system (roads, vehicles and regulations) ought to be such that the likelihood of collisions between children and vehicles would be vanishingly small, and the impact slight . . . <sup>22</sup>

JA Michon

### Considering the needs of the elderly and physically challenged

Physiological changes that occur with age involve a deterioration of sensory and physical capabilities to include vision, audition, cognition, and postural and gait function. Simply put, many elderly often do not see, hear, or walk well.

The decline in peripheral vision increases the chance of not seeing approaching vehicles from the side. The decline in static acuity, the ability to resolve fine spatial detail in the absence of motion, negatively affects the ability to read a crossing signal message or instructions. The decline in dynamic acuity, the ability to resolve fine spatial detail of objects in motion relative to the viewer, negatively affects scanning ability, presenting obvious road safety problems. The decline in depth perception associated with aging reduces the ability to accurately judge oncoming traffic, the width of crossings, and the height of curbs.

Progressive hearing loss with age also presents traffic problems for the non-motorized traveler. Individuals with hearing loss must increasingly rely on visual cues for traffic recognition.

The slowing of motor processes, reaction time, and complex cognitive processes in combination with an increased sense of cautiousness, reduces the ability to effectively respond to approaching traffic or unexpected events in the environment. The use of some medications makes the problem worse. What may have been at one moment a correct decision, if not acted upon immediately, could result in an incorrect decision.

Limited neck and trunk flexibility further reduces scanning ability and contributes to the elderly pedestrian being overrepresented in vehicle turning movement crashes at intersections.

## The design trail user

“Those having slower walking speeds have the moral and legal right to complete their crossing once they have lawfully entered the crossing.”

*Traffic Control Devices Handbook.*

### A Few Words on the Americans with Disabilities Act

Signed into law in 1990, the Americans with Disabilities Act (ADA) assures accessibility for all individuals to all facilities. Standards are set by the Architectural and Transportation Barriers Compliance Board, the Uniform Federal Accessibility Standards, and the American National Standards Institute (ANSI) A117.1 codes. Designers of public facilities such as trails must comply with ADA.

### Census data

Population statistics also bear out the importance of designing to accommodate children and the elderly. According to the 1990 U.S. census, more than one-eighth of the United States' 249 million population comprises citizens 65 years and older, and more than one-quarter of the population is 17 years and younger. Combined, these two groups represent almost 40 percent of Americans.<sup>23</sup>

In Florida, the under 16 and 65+ age groups represented 19.8 percent and 18.3 percent of residents respectively in 1990.<sup>24</sup>



The popularity of trails spans the generations.

## The design process

This section is based on a paper entitled “Research within the framework of the Dutch ‘Master Plan Fiets’”<sup>25</sup> and is intended to remind the designer of the analytical nature of the design process.

Trail designers should devote more attention to human behavior at two complementary levels:

- ▶ in existing situations—by studying the discrepancies between planned for and actual behavior;
- ▶ in the design process—by analyzing the tasks of the motorists and the trail users.

Deviations between expected and actual behavior can be explained two ways:

- ▶ the behavior intended by the designer is too complex for the user—his skills are overestimated;
- ▶ the expected behavior is too inconvenient for the user.

Analyzing the tasks of the intended users should occur early in the design process and focus on trying to determine:

- ▶ the extent to which the expectations of the motorists and trail users will correspond regarding giving and being given right-of-way;
- ▶ which mistakes trail users and motorists could make prior to implementation of the design;
- ▶ how high the risk is that they will make these mistakes;
- ▶ how serious will making a mistake be. The severity of a mistake is largely determined by the direction, mass, and speed of vehicles.

When analyzing the task of the trail-user, designers should consider not only individual junctions, but also the trail and trail network as a whole. Designers should strive for consistency, attempt to reduce the number of inconsistencies, and mitigate them where they do exist.

Inconsistencies can take the form of:

- ▶ changes in the space available for trail users;
- ▶ differences in junction configuration, in right-of-way regulations between successive junctions, or in sign placement and pavement markings;
- ▶ changes in the speed of crossing motor vehicle traffic;
- ▶ transition to a situation in which trail and motor vehicle traffic has become merged.

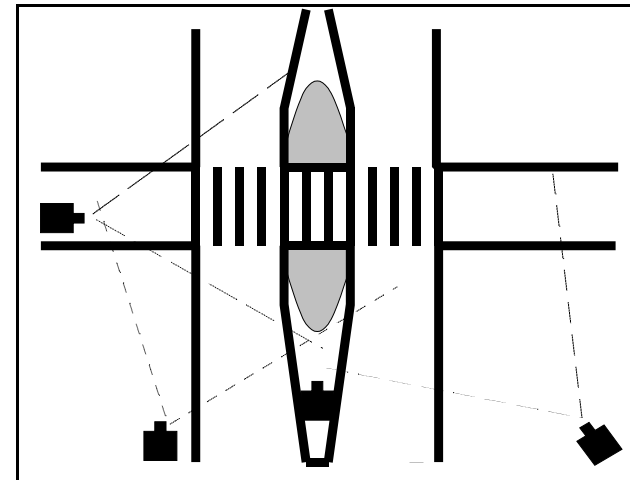

**Figure 3.** Different views are required for fully analyzing an intersection.

## Design principles

According to the AASHTO *Green Book* and the *MUTCD*, the following have been suggested as measures with potential to aid the elderly pedestrian:

- ▶ lower walking speed criterion, particularly at wide signalized intersections;
- ▶ provide refuge islands at wide intersections;
- ▶ provide lighting and eliminate glare sources;
- ▶ consider the traffic control system in the context of the geometric design to assure compatibility;
- ▶ provide adequate advance warning of situations that could surprise or adversely affect safety;
- ▶ use enhanced standard traffic control devices;
- ▶ provide oversized, retroreflective signs with suitable legibility and consider increasing sign letter size to accommodate individuals with decreased visual acuity;
- ▶ use properly located signals with large signal indications;
- ▶ provide enhanced markings and delineation;
- ▶ use repetition and redundancy (*Author's Note. Excessive repetition and redundancy can breed contempt*).

It seems reasonable to conclude that such measures may also be beneficial to other trail users.



The Stadium Trail crossing Chapel Drive, Tallahassee, Florida.

Building upon this list, another in a paper entitled “Designing Pedestrian Friendly Intersections,”<sup>26</sup> and a third compiled at a trails/roadway intersection design caucus held at the National Rails-to-Trails Conference on October 1993 in Concord, California, this manual suggests the following compendium:



## Design principles

### Principles of “friendly” design

- ▶ Design for the full spectrum of trail users—young and old, slow and fast, bicyclists, skaters, and walkers.
- ▶ When assigning right-of-way, give trail users at least the same rights as the motoring public, and provide clear right-of-way assignment.
- ▶ Provide positive guidance for trail users and motorists to ensure full awareness of the intersection.
- ▶ Minimize conflicts and channelize the intersection to separate conflicting movements.
- ▶ Unavoidable conflicts should occur at right angles.
- ▶ Optimize sight triangles, ensuring stopping, intersection crossing, and decision sight distances. Conflicts should be clearly visible.
- ▶ Reduce motor vehicle speed through “traffic calming” techniques as appropriate.
- ▶ Minimize trail user crossing distance with a median refuge area or by narrowing the roadway as appropriate.
- ▶ Provide adequate staging and refuge areas for trail users.
- ▶ Discourage unwanted motor vehicle intrusion onto the trail while enabling emergency and maintenance vehicle entry.
- ▶ Avoid obstacles and visibly highlight unavoidable obstacles.
- ▶ At signalized intersections, minimize trail user delay by minimizing traffic signal cycle time.
- ▶ Provide adequate signal crossing time for design pedestrians.
- ▶ Provide easily accessible tactile/audible pushbuttons.

- ▶ Treat every road as a potential trail entrance and exit point, integrated with sidewalks and on-street bicycle facilities as appropriate.
- ▶ Design to assist the trail user in looking in the direction of the potential hazard.
- ▶ Consider the potential for sun blinding.
- ▶ Consider lighting.
- ▶ Consider the ease of both construction and maintenance and the initial and lifetime costs for construction and maintenance.
- ▶ Be consistent in design.



Provide clear right-of-way assignment.

# Design principles



Provide easily accessible tactile/audible pushbuttons.



Provide adequate staging and refuge areas for trail users.



Optimize sight triangles. Conflicts should be clearly visible.



Visibly highlight obstacles.

# Crossing types

Trail-roadway crossings may be categorized into three main types:

- ▶ Midblock;
- ▶ Parallel Path;
- ▶ Complex Intersection.

Each of these types may cross any number of roadway lanes, divided or undivided, with varying speeds and volumes, and may be uncontrolled, or more typically, sign or signal controlled.

## Midblock

Midblock type crossings are situations at which the trail crosses a roadway far enough from any other junction so that there are no close proximity or unexpected motor vehicle turning movements that the trail user may encounter (Figure 4). This is the most straightforward and desirable of the three configurations. As with all intersections, the designer should strive to conform to the principles of “friendly” trail intersection design outlined in Chapter 2.

While the intersections depicted in Figures 4 and 5 are very simplistic, there are many variables for the designer to consider that add complexity. These are discussed in detail in later sections and include issues such as, traffic control devices, sight distance, refuge island use, access control, pavement markings, and others.

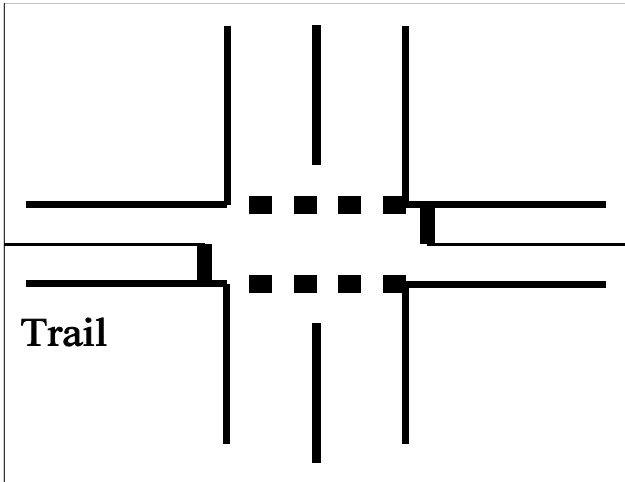

Figure 5. Example Midblock type crossing—roadway with right-of-way.

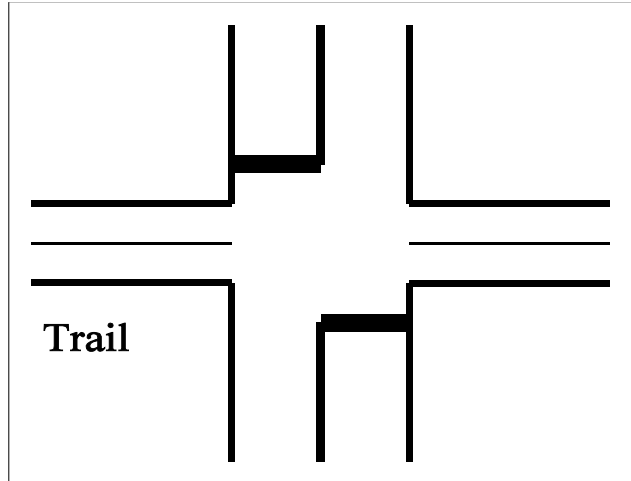
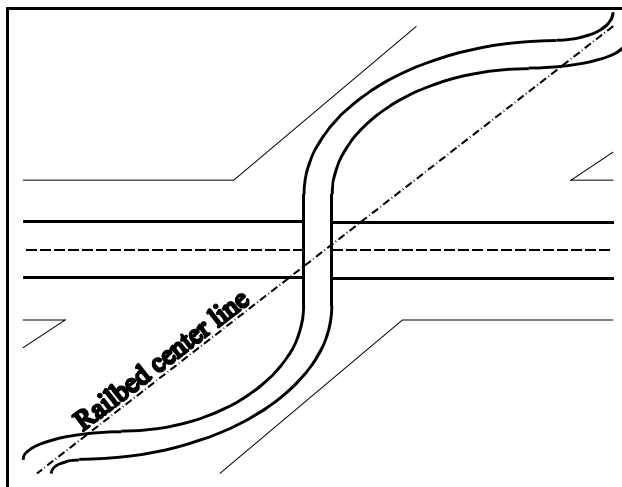

Figure 4. Example Midblock type crossing—trail with right-of-way.

## Crossing types

Ideally, the crossing should be at right angles. The typical redesign of a diagonal road crossing of a rail-trail by curving the trail to achieve an optimal 90-degree approach is shown in Figure 6.

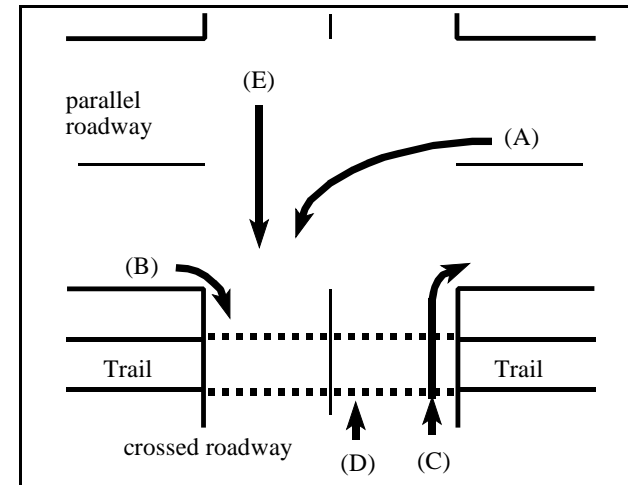

**Figure 6.** Typical redesign of a diagonal road crossing.

If right-of-way is a constraint in providing for design speed curvature or is a cost concern, the crossing may be angled a maximum of 75 degrees, thus reducing right-of-way requirements. This slight compromise lengthens the crossing by only 4%.

### Parallel Path

These type crossings occur where a trail closely parallels a roadway and crosses another roadway (or driveway) near the intersection (Figure 7). With this configuration, the trail user is faced with potential conflicts from motor vehicles turning left (A) and right (B) from the parallel roadway, and on the crossed roadway (C, D, E).



**Figure 7.** Example Parallel Path type crossing.

The major road may be either the parallel or crossed roadway. Right-of-way assignment, traffic control devices, and separation distance between the roadway and trail are also variables of utmost importance which greatly affect the design of this type intersection.

## Crossing types

Further complicating the situation is the possibility of the conflicts being unexpected by both trail users and motorists. Clear sight lines across corners are especially necessary.

At crossings at which the roadway intersection is signalized and the trail is controlled by a “walk/don’t walk” signal in phase with the parallel roadway, conflicts are especially unexpected. The trail user may be lulled into a false sense of security by the “walk” signal while at the same time turning motorists from the parallel roadway have the green signal.

Trail users with their backs to the turning vehicle are even more susceptible to unexpected conflict. On the Figure 7 diagram, trail users moving left to right are more vulnerable to (B) motor vehicles, and those right to left are exposed to (A).

To heighten awareness on the trail, a yellow sign with black lettering warning the trail user to “Watch for Turning Vehicles” can be used. On the crossed roadway, bicycle or pedestrian advance crossing signs and crossing signs should be installed. On the parallel roadway, a modification of the advance railroad crossing sign is suggested (see Figure 11 page 3-7).

### (A) Left turning motor vehicles

The left turning motorist waiting for a gap in approaching traffic is of particular importance. Here, the driver’s attention is focused on gap selection. Accelerating through the turn, the driver is then almost immediately faced with the unexpected trail crossing.

While the driver was waiting to make the turn, a fast-moving right-to-left bicyclist or skater, who is out of the driver’s field of view, may have overtaken, setting up a very hazardous conflict.

Finally, upon slowing or stopping for the trail user, this left turning motor vehicle may interfere with thru traffic on the parallel roadway.

Permissive left turns should be prohibited on busy parallel roads and high use trail crossings. Instead, a protected left turn should be provided at which time the trail user receives a “don’t walk” signal. If a permissive left is in place, the trail should be setback 4 - 10 m from the roadway to allow motor vehicle stacking space.

### (B) Right turning motor vehicles

It is important to control the speed of right turning vehicles, especially when the parallel roadway has a dedicated right turn lane or where there is a large turning radius which both tend to encourage high speed turns.

A speed hump, known as the Hague Hill, is sometimes used in The Netherlands (Figure 8). This device not only forces lower speeds, but also serves to warn the motorist of an unusual situation.

## Crossing types

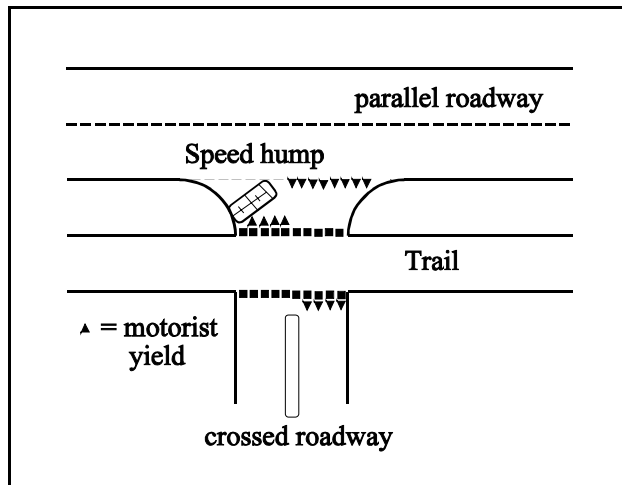

**Figure 8.** Hague Hill speed hump in The Netherlands.

Establishing as small a turning radius as is practicable is another effective measure for reducing turning speed.

### **(C and D) Motor vehicles on the crossed roadway**

To stop motorists prior to the trail crosswalk and to discourage obstructing the crossing, a stop bar with sign R10-6, “Stop Here on Red,” may be positioned in advance of the trail crosswalk. Where the crossed roadway is controlled by a stop sign, it may be possible to install it in advance of the trail.

When the crossed road has multiple lanes, through or turning, the view of the trail to the left may be obstructed by standing traffic for those (C) motorists wishing to make a right-turn-on-red onto the parallel roadway. This creates a very hazardous situation when the driver proceeds across the trail crosswalk prior to making the right turn. Five near-collisions involving right-on red vehicles were observed in less than 4 hours at a Pinellas Trail intersection (Figure 9).

Prohibit right-turn-on-red and motor vehicle advancement across the trail in high volume situations. Where there is a right turn only lane, a speed table in this lane in advance of the trail may be an appropriate treatment.

### **(E) Motor vehicles on the crossed roadway**

It is important to provide these drivers with adequate clearance intervals to ensure their clearance of the trail prior to the trail receiving a “walk” signal. An all-red phase can be used to further protect trail users.

# Crossing types

On the Pinellas Trail at Curlew Avenue, there were 152 separate trail user crossings by individuals or groups in a three hour 43 minute time period on a Saturday afternoon. Of these crossings, 60 (39%) were made with no motor vehicle present and 47 (31%) were with a motor vehicle present but there was no “incident.” The remaining 45 (30%) were with a motor vehicle “incident.” Of these, the “incident” was trail user: delay by moving motor vehicle (symbol w, 29 total); blocked by obstructing stopped motor vehicle (symbol k, 11 total); or conflict with a motor vehicle (symbol f, 5 total). A conflict was defined as a near collision. Figure 9 depicts a detailed breakdown of these “incidents” by trail user and motor vehicle travel direction.

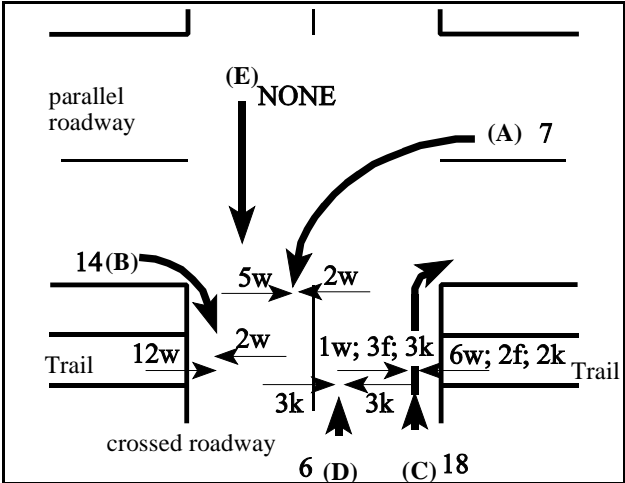

**Figure 9.** “Incidents” on the Pinellas Trail at Curlew Avenue. w = delay; k = blocked; f = conflict.

For example, there were 14 “incidents” involving right turning motor vehicles (B). Twelve involved left-to-right → trail user delay and two involved right-to-left ← trail user delay (there were no blocked or conflict incidents).

# Crossing types

**Separation distance**

The distance between the parallel roadway and trail (Figure 10) has a pronounced effect on operations. At issue is:

- ▶ turning motor vehicle approach speed to the trail;
- ▶ stacking space between the parallel roadway and trail;
- ▶ driver recognition of the trail;
- ▶ trail user recognition of turning motor vehicles; and
- ▶ trail right-of-way prioritization.

Table 3 shows the effects of separation distance on these operations parameters.

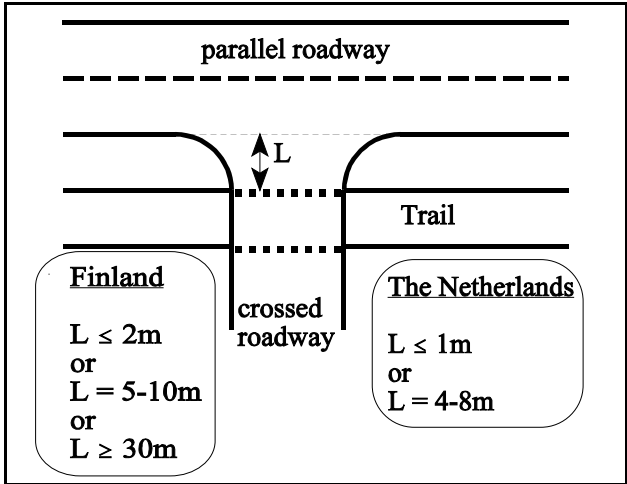

**Figure 10.** Trail spacing near a roadway junction. (1m = 3.28 ft)

**Table 3.** Effects of trail-roadway separation distance.

Parameter	Separation distance		
	<1-2 m	4-10 m	>30 m
Motor vehicle turning speed	Lowest	Higher	Highest
Motor vehicle stacking space	None	Yes	Yes
Driver awareness of trail user	Higher	Lower	High or Low
Trail user awareness of motor vehicles	Higher	Lower	Highest
Chance of trail right-of-way priority	Higher	Lower	Lowest

(1m = 3.28 ft)

It is recommended that the separation distance categories—<1m to 2 m; 4 m to 10 m; or >30 m—in Table 3 be adhered to. They are a composite of the specifications from Finland and The Netherlands as shown in Figure 10. Note that these categories are exclusionary.



# Crossing types

### A proposed new sign

The abandonment of railroad lines and subsequent railbanking and conversion to multi-use trails often creates parallel path type crossings. Part 8B-3 of the *MUTCD* specifies the installation of Railroad Advance Warning Signs W10-2, 3, or 4 for use on roadways that are parallel to railroads. A proposed modification of sign W10-2 to warn right turning motorists of a parallel trail crossing is shown in Figure 11. A similar sign warning left turning motorists would also be valuable.

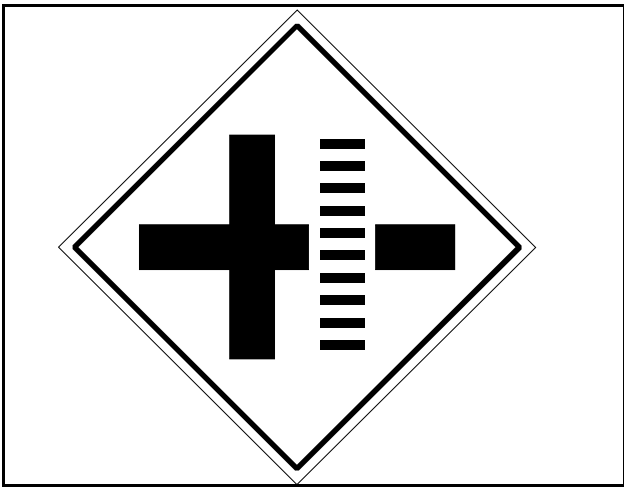
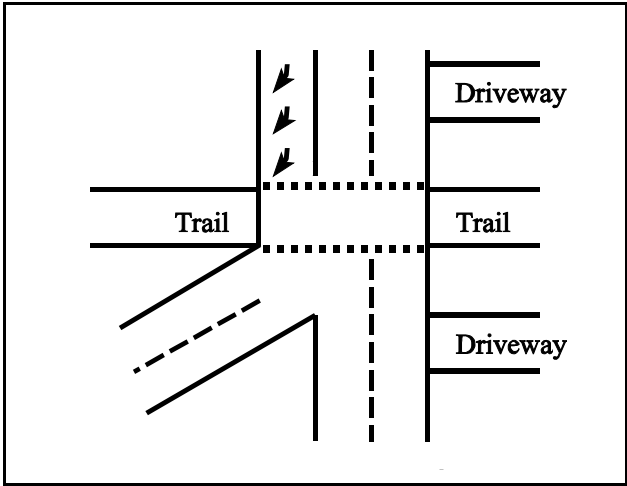

**Figure 11.** Railroad Advance Warning Sign W10-2 modified for parallel path right turn application.

### Complex Intersection

These type crossings constitute all other trail-roadway or driveway junctions. These may include a variety of configurations at which the trail crosses directly through or near a roadway intersection and there may be any number of motor vehicle turning movements (Figure 12).

It is critical for the designer to view the junction from the perspective of both the trail user and motorist, and to pay careful attention to potential conflicts from turning motor vehicles.

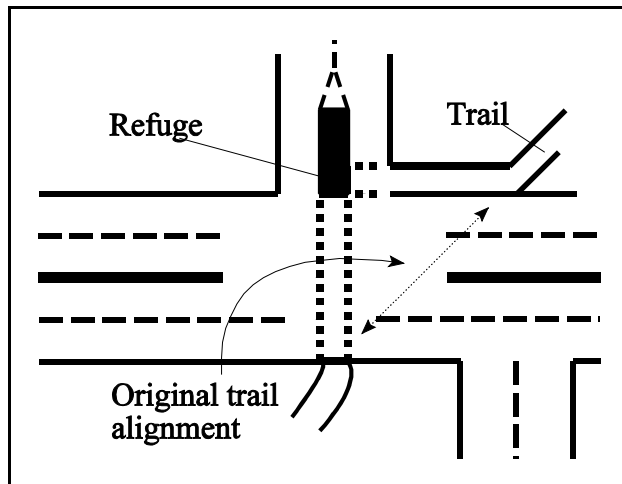

**Figure 12.** Example Complex Intersection type crossing.

## Crossing types

Under certain situations it may be advisable to provide the trail user with a two-step crossing that directs trail users to make two separate movements. This is typically done where, because of alignment constraints, the trail-roadway intersection is skewed markedly from the 90 degree optimum and a trail re-alignment as shown in Figure 6 is not possible.

The designer should carefully consider the task of the trail user to ensure the ease and safety of the expected maneuver. If another intersecting roadway complicates the situation, a two-step crossing with a refuge area can establish right angle or nearly right angle maneuvers to simplify the crossing task (Figure 13).



**Figure 13.** Example Complex Intersection Two-Step type crossing.

It should be noted, however, that many bicyclists or skaters do not follow the two-step crosswalk markings, preferring to follow the original trail alignment which is the most direct route.

The Pinellas Trail intersections at Myrtle Avenue (4 lanes) and at Seminole Blvd. (6 lanes) are configured as two-step crossings similar to Figure 13. At Myrtle Avenue 22% of the trail users crossed as a two-step, 56% used the original trail alignment, and 21% chose a hybrid pattern. At Seminole Blvd. 68% were made as a two-step. However, because the refuge island did not have curb cuts, only 23% of these bicyclist/skater two-step crossers actually used the refuge as intended by the designers.

Complex Intersection type crossings are truly a “mixed-bag.” Every situation is different and no single solution can apply. By following the principles of “friendly” design and using good engineering and sound judgement, a safe and functional intersection can be designed.

# Regulating traffic

## Assigning right-of-way

According the *Traffic Control Devices Handbook*, the following conditions should *normally* be assigned right-of-way:

- ▶ heavier volume of traffic;
- ▶ higher speed traffic; and
- ▶ superior classification of highway.

These dominance-based criteria give a trail little chance of right-of-way assignment. At the least, motor vehicle traffic is always faster than bicycle or pedestrian traffic. But should “might make right” in all situations?

The classification of highway criterion deserves scrutiny. Trails could be considered inferior to any road. However, bicycles *are* vehicles, and trails could be afforded an equal or elevated status and be functionally classified based on a rational assessment of their importance. Thus, the Pinellas Trail, for example, could be considered a non-motorized principal arterial, superior to many of the minor roads it crosses.

Volume, speed, and highway classification should not be the only criteria to consider when assigning right-of-way at a trail crossing. The comfort and convenience of the trail user, and the unique behavioral characteristics of the trail user and motorist alike must also be taken into consideration.

The Europeans have settled on this more equitable balance of needs. For example, in The Netherlands, “chance of stop” is a criterion of the main requirement of comfort. The average maximum number of stops per kilometer is specified as .5 on a through route, 1.0 on a distributor, and 1.5 on an access bicycle route.

Compare these specifications to the distances between stops on a portion of the Pinellas Trail in April 1995, shown in Figure 14.

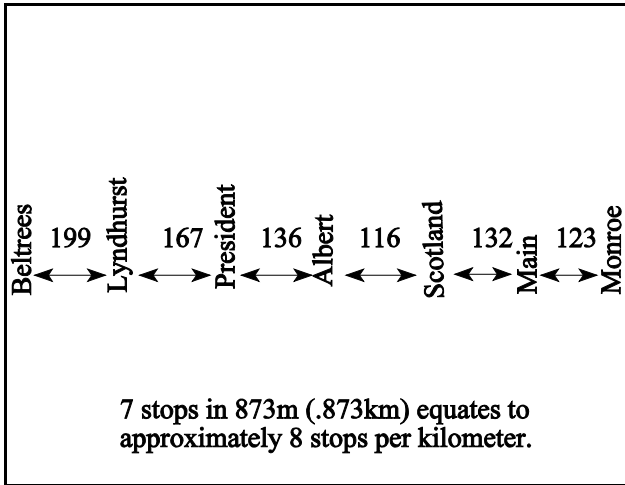

**Figure 14.** Distance (m) between stop signs on the Pinellas Trail in Dunedin, FL. (1m = 3.28 ft)

## Regulating traffic

Regarding behavior, it must be recognized that trail users have:

- ▶ very low delay tolerance (see Table 5, page 3-12);
- ▶ a strong desire to maintain momentum;
- ▶ little traffic knowledge (children); and
- ▶ sometimes a “regulations don’t apply to me” mentality.

The Pinellas Trail at President St. is a 4-way stop in a quiet residential neighborhood. In a 3-hour period there were 67 motor vehicle crossings. All were full stops. Of 77 bicyclist crossings, *none* were a full stop. Ten (13%) were a rolling stop, and 67 (87%) were no stop.

At Poinsettia St., another 4-way stop, there were 900 motor vehicle and 150 bicyclist crossings. Twenty (13%) bicyclists came to a full stop, 34 (23%) a rolling stop, and 96 (65%) no stop. Motorist stopping behavior was not determined.

Also at Poinsettia Street, there were 42 cases in which the motorist arrived at the intersection prior to or nearly simultaneous with the bicyclist (34) or skater (8). Of these, 36 (86%) resulted in the motorist departing the intersection *after* the trail user. (Often, the courteous motorist has “waved” the bicyclist through. This can lead to danger when another bicyclist, perhaps from the opposite direction, mistakenly assumes the same favor.)

When stop signs are incorrectly installed on a trail at extremely low volume intersections or even driveways, the temptation for trail users to disregard them is especially great. The bicyclist or skater is, in effect, being taught this dangerous behavior by these “crying wolf” signs since he or she thinks that there is little chance of cross traffic.

Assigning incorrect priority or being overly restrictive in an attempt to protect the trail user can lead to confusion and unsafe practices by both trail users and motorists, and increase the potential for a collision.



If motorists are asked to stop, why also stop trail users?

# Regulating traffic

Derived from text in *Sign Up For The Bike*, Table 4 depicts conditions under which bicyclists on local and distributor bicycle routes in The Netherlands may be given right-of-way with respect to motor vehicle 85th percentile speed and volume.

**Table 4.** Right-of-way assignment in The Netherlands.

Speed	Right-of-way (ROW) assignment		
>50 km/h (>31 mi/h)	Bicycles not given ROW		
30-50 km/h (19-31 mi/h)	Bicycles <b>may</b> be given ROW only <i>with</i> the use of speed limiting measures to slow motor vehicles.		
<=30 km/h (<=19 mi/h)	Bicycles <b>may</b> be given ROW <i>without</i> the need for motor vehicle speed limiting measures.		
MV Peak Hour Volume	up to 250	up to 600	> 600

(1 km/h = .62 mi/h)

## The level of control

### Background

Where trails intersect with roads, some interruption of traffic flow on either the trail or roadway, or both, is inevitable. Traffic control devices (TCDs) such as yield and stop signs, and traffic signals are used to assign right-of-way and avoid conflicting movements while attempting to maintain a high level of operating efficiency.

Designers are reminded of the following requirements of a traffic control device:

- ▶ fulfill a need;
- ▶ command attention;
- ▶ convey a clear, simple meaning;
- ▶ command respect of road users;
- ▶ give adequate time for proper response.

### Establishing the need

Warrants for the application of TCDs are expressed in the *MUTCD* as numerical requirements or as general policy statements. Warrants are a series of guidelines—not absolute values—that should be used in evaluating a situation.

The satisfaction of a warrant is not proof that a TCD is needed, and failure to fully satisfy any specific warrant does not guarantee that the device could not serve a useful purpose. The application of warrants is effective only when combined with sound engineering judgement.

# Regulating traffic

It is recommended that some form of regulatory traffic control device be installed at all trail-roadway or -driveway junctions.

A gap adequacy study may be used to determine the level of control needed. Many factors directly affect gap acceptance and gap adequacy. These include:

- ▶ vehicle volumes and speeds;
- ▶ street width and geometrics;
- ▶ walking/bicycling speed;
- ▶ perception/reaction time;
- ▶ time waiting;
- ▶ traffic experience and risk tolerance;
- ▶ sight distances.

An acceptable or adequate gap time may be defined as the minimum time between vehicles that 85 percent of all groups waiting to cross a street will accept. Local conditions may warrant a study of all gaps at a location, and gap distribution characteristics or local policy may result in defining an acceptable gap at a point other than the 85th percentile.

Three studies are of particular relevance when considering gap acceptance of pedestrians and bicyclists.

Kaiser concluded that pedestrian limits of delay tolerance are about half that of motorists.<sup>27</sup> Using this supposition and Highway Capacity Manual Chapter 9, he developed a delay based level of service schedule for pedestrians shown in Table 5. Vehicle average delay is shown for comparison purposes.

**Table 5.** Delay based level of service.

Level of Service	Pedestrian Delay (sec)	Vehicle Delay (sec)
A	0 - 5	0 - 5
B	5 - 10	5 - 15
C	10 - 15	15 - 25
D	15 - 20	25 - 40
E	25 - 30	40 - 60

The criteria in Table 5 are also applicable to bicyclists and skaters.

In a study of bicycle traffic at urban intersections, Opiela et al. found that the average accepted gap was 3.9 s and the minimum accepted was 1.1 s. Average rejected gap was 2.6 s and the maximum was 8.1 s. The critical gap was 3.2 s.<sup>28</sup> A

# Regulating traffic

limitation of this data is that it was collected near a college campus, so the results may be applicable to only this population of bicyclists.

Bicycle path-roadway intersection simulation model research was conducted in the early 1970's to evaluate the total delay and delay distribution of bicycle and motor vehicle traffic for various flow rates and traffic control measures. Figure 15 indicates the traffic control warrants that were developed.<sup>29</sup> It is not known to what extent these warrant criteria have been applied in practice.

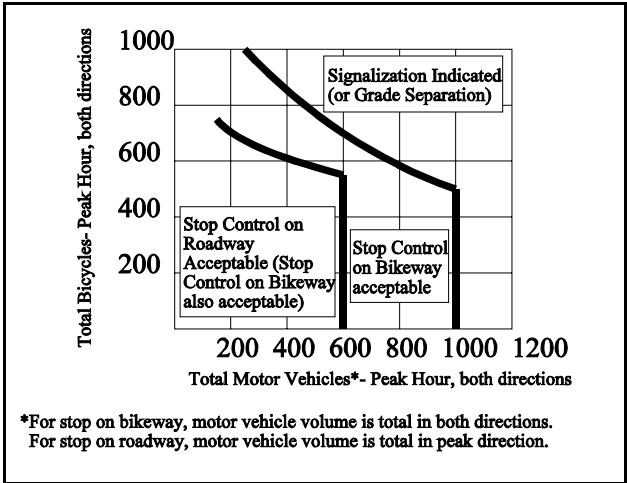

**Figure 15.** Example warrants for an independent bike path crossing a two-lane roadway.

## Choosing crossing treatment

Appendix A shows crossing treatments used in The Netherlands and Finland with respect to motor vehicle speed and functional classification of the bicycle trail (The Netherlands) or motor vehicle volume (Finland).

Tables 6 and 7 on pages 3-18 and 3-19 depict crossing treatment recommendations with respect to number of lanes and motor vehicle speed and volume. They are in part a composite of the European standards and are suggested guidelines, not absolutes. Engineering judgement is necessary for each intersection.

## Traffic signs

The *MUTCD* encourages a conservative use of signs. Overuse of signs and unnecessary signs diminish effectiveness in modifying behavior, wastes taxpayer dollars to place and maintain, and are a visual blight.<sup>30</sup>

Unnecessary STOP signs breed contempt and disrespect for necessary STOP signs.

*Traffic Control Devices Handbook*

## Regulating traffic

Because a bicyclist may be inclined forward, lowering the field of vision, signs along trails should be mounted slightly lower—1.2 - 1.5 m (4 - 5 ft) is typical height—than signs directed specifically to motor vehicle drivers. Signs should be set 0.9 - 1.8 m (3 - 6 ft) laterally off the pavement edge as shown in Figure 9-1 of the *MUTCD*. Warning signs on the trail should be 18" x 18" to reduce the visual clutter.

**Regulatory Signs** should be used only when the legal requirement is not otherwise apparent.

- ▶ yield sign;
- ▶ stop sign;
- ▶ traffic signal signs R10-1 to R10-4.
  - Cross on Green Light Only
  - Cross on Walk Signal Only
  - Push Button for Green Light
  - Push Button for Walk Signal

The yield sign for the trail or road may be used where the available sight distance results in a safe Critical Approach Speed that exceeds 16 km/h (10 mi/h)(yield warrant 1 in the *MUTCD*). The methodologies that have been developed to determine this for motor vehicles are applicable for bicyclists.

If a stop sign is to be used on the trail, it is especially important

to place it as close to the intended stopping point—the edge of the crossed road—as possible, and supplement it with a stop line, generally placed 1.2 m (4 ft) from the edgeline. The STOP pavement marking may also be used.



Signs should be informative, but placed to not obstruct views.



# Regulating traffic

If a sidewalk along the roadway intersects with the trail, the stop sign should be placed 1.2 m (4 ft) in advance of the marked or unmarked crosswalk across the trail. If the sidewalk setback from the roadway is 3.7 m (12 ft) or more, then it is considered to have its own alignment, should be marked across the trail, and should yield to the trail crossing (Figure 16).

If trail median access control is used (Figure 26, pg. 3-32), the sidewalk may be routed through the median at grade if necessary.

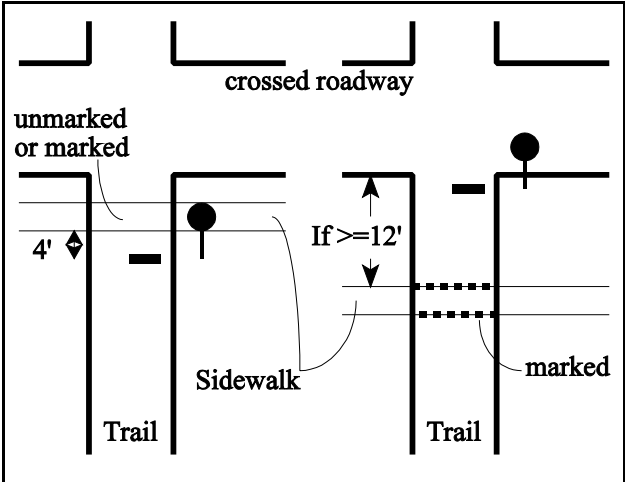

Figure 16. Sidewalk crossing a trail.

The *Traffic Control Devices Handbook* discourages multi-way stop signs for roadway application. Building upon this, it is strongly recommended that multi-way stops not be used at trail intersections because of the demonstrated inconsistent behavior of trail users and motorists at these installations.

**Warning Signs** are used to inform of unusual or unexpected conditions. They should be placed to provide adequate response time.

- ▶ Advance Crossing Signs—W11-1 for bicycles and W11-2 for pedestrians. These may be supplemented with an auxiliary distance sign specifying the distance to the trail crossing.

Text in 9B-14 of the *MUTCD* specifies that the Advance Bicycle Crossing sign “should be erected about 750 feet in advance of the crossing location in rural areas where speeds are high, and at a distance of about 250 feet in urban residential or business areas, where speeds are low.” However, it is recommended that specifications in the *MUTCD*, Table II-1, *A Guide For Advance Warning Sign Placement Distance*, be followed. The *MUTCD* specifies a 30" x 30" size, but a 36" x 36" sign may be useful, especially on higher speed or wider streets, or in rural areas.

# Regulating traffic

- ▶ Crossing Signs (W11A Series). These are distinguished from Advance Crossing Signs by the addition of crossing lines on the symbol plate and may be used immediately adjacent to the trail crossing. If the approach to the intersection is controlled by a signal, stop sign or yield sign, the crossing sign may not be needed.
- ▶ STOP AHEAD (W3-1) or YIELD AHEAD (W3-2a) signs may be used for emphasis on the road or trail.

## Traffic signals

Traffic signals are appropriate under certain circumstances, with warrants for installation as discussed in the *MUTCD*. Though none of the 11 Warrants specifically address trail crossings, they *could* be used since the bicycle *is* considered a vehicle, and trails *could* be functionally classified.

Again, Tables 6 and 7 (pages 3-18 and 19) give suggested signal installation guidelines.

Another criterion could be the development and adoption of a new warrant, perhaps based on the delay schedules from Table 5 (page 3-12). For example:

*Warrant 12: Trail Crossings. The warrant is satisfied for an established trail crossing when a gap study shows that for any one hour period when the trail is being used, the average trail*

*user delay falls below Level of Service E.*

The signal actuation mechanism should be mounted beside the trail 1.2 m (4 ft) above the ground and easily accessible. This enables the bicyclist to activate the signal without dismounting. Another method of activating the signal is to provide a detector loop in the trail pavement, though this works only for bicyclists.

On signalized divided roadways, a push button should also be located at the median to account for the slower trail users who may have been trapped in the refuge area.

Some situations may warrant flashing red and yellow warning lights or specialized trail crossing lights.



The Cady Way Trail at Bennett Road, Winter Park, Florida.

## Regulating traffic

The designer may consider giving a “hot response” or immediate call to encourage trail users with the shortest possible wait.

### An innovative design

Designing a trail intersection is much more than merely determining right-of-way, sign or signal. Crosswalk, refuge area, and traffic calming installations must also be considered. If the trail is given right-of-way, it may be advisable to reinforce this and control the speed of motor vehicles through the use of such traffic calming measures as narrowing the road, installing a median, or by designing the trail itself as a speed table as shown in a design from *Making Ways for the Bicycle* (Figure 17). This design is appropriate on roads with 85% speed less than or equal to 40 km/h (25 mi/h) and ADT less than 2000.

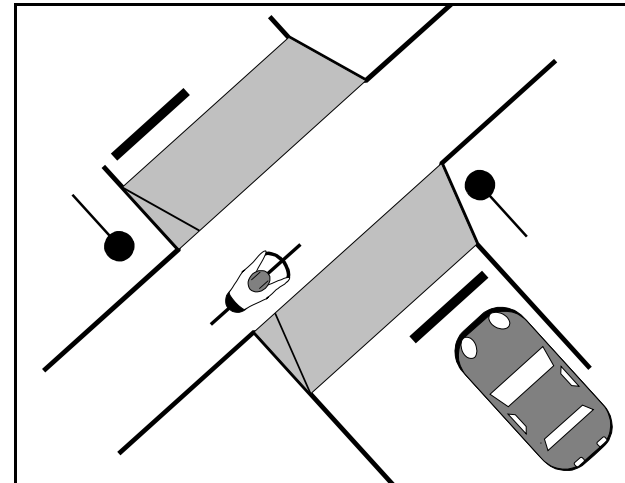

Figure 17. Trail as speed table.

# Regulating traffic

**Table 6.** Suggested treatments on two-lane road crossings.

<b>Two-Lane Road Crossings</b>				
<b>ADT/ Speed (85%)</b>	<b>&lt;2000</b>	<b>2,000-4,999</b>	<b>5,000-9,999</b>	<b>10,000+</b>
<b>&lt;=40 km/h (25 mi/h)</b>	Yield with traffic calming or Stop sign calming optional	Stop sign calming optional	Stop sign with added traffic calming	Consider signal
	Yield refuge not needed	Yield or Stop refuge optional	Stop sign with refuge area or Signal	
<b>50-60 km/h (30-35 mi/h)</b>	Stop sign calming optional	Stop sign with added traffic calming	Stop sign with refuge area or Signal	Consider signal
	Yield or Stop refuge optional	Stop refuge optional		
<b>65-75 km/h (40-45 mi/h)</b>	Stop sign refuge optional	Stop sign with refuge area	Stop sign with refuge area or Signal	Consider signal
<b>80+ km/h (50+ mi/h)</b>	Stop sign refuge optional	Stop sign with refuge area	Consider signal	Consider signal
<b>Trail given right-of-way</b>	<b>Roadway given right-of way</b>	<ul style="list-style-type: none"> <li>- Criteria are for two thru lanes. In general, if turn lanes are present, move one cell to the right for each turn lane.</li> <li>- Yield conditions must satisfy MUTCD Warrant 1. Give precedence to Yield over Stop.</li> <li>- Trail as speed table is acceptable traffic calming for cell &lt;2000 / &lt;=40 km/h only. For other cells, the traffic calming may be lane narrowing (splitter island/refuge area/choker) or some other accepted method.</li> </ul>		

# Sight distance

**Table 7.** Suggested treatments on four (or more) lane road crossings.

<b>Four (or more) Lane Road Crossings</b>			
<b>ADT/ Speed (85%)</b>	<b>&lt;10,000</b>	<b>10,000- 19,999</b>	<b>20,000+</b>
<b>&lt;=60 km/h (35 mi/h)</b>	Refuge area, preferably protected	Protected refuge or Signal	Signal or grade separated
<b>&gt;=65 km/h (40 mi/h)</b>	Protected refuge or Signal	Signal	Signal or grade separated

# Sight distance

Sight distance is a principal element of roadway and trail design. Three types are of particular importance when designing trail intersections:

- ▶ stopping sight distance;
- ▶ intersection sight distance; and
- ▶ decision sight distance.

## Stopping sight distance

Stopping sight distance enables a vehicle—motorized or bicycle—traveling at or near the *design* speed to stop before reaching a stationary object in its path. It is the sum of the distance covered in the perception-reaction time plus the actual braking distance.

Equation (1) from AASHTO's *Guide for the Development of Bicycle Facilities* is used. A total perception and brake reaction time of 2.5 seconds is assumed.

$$S = \frac{V^2}{30 (f \pm G)} + 3.67 V \quad (1)$$

$S$  = minimum sight distance, feet (1 ft = .3048 m)

$V$  = velocity, mi/h (1 mi/h = 1.61 km/h)

$f$  = coefficient of friction (use 0.25)

$G$  = grade (feet/feet) (+  $G$  for ascending; -  $G$  for descending)

## Intersection sight distance

At an intersection, a person must have sufficient sight distance to make a safe departure for a right turn, left turn, or, especially in the case of trail users, crossing maneuver. Intersection sight distance gives a measure of control for personal safety to the trail user.

The amount of crossing maneuver sight distance necessary for trail users depends on the time needed to cross the intersection from a full stop and the distance that crossing motor vehicle traffic, appearing after the crossing movement has begun and operating at the design speed, will travel in that time. The time to cross is a function of trail-user reaction time, crossing performance, and the crossing width (Figure 18).

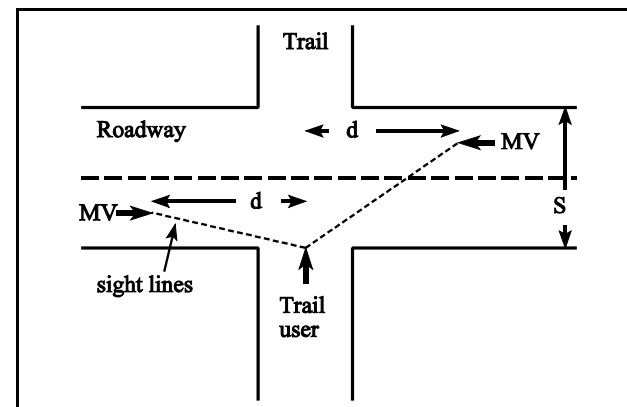

**Figure 18.** Intersection crossing maneuver sight distance.

## Sight distance

From the *Green Book*, crossing sight distance ( $d$ , feet along roadway) is determined using the equation:

$$d = 1.47V(J + t) \quad (2)$$

1.47 = conversion factor

$V$  = design speed (mi/h) of the crossing road

$J$  = perception-reaction time (= 2 seconds for motorists)

$t$  = time required to accelerate and traverse distance  $S$  (feet) to clear the road.

$S$  is the sum of the pavement width, the distance from the near edge of the pavement to the front of a stopped vehicle, and the overall length of the vehicle.

For motor vehicles,  $t$  is given in a table for different values of  $S$ .

### Bicyclists

For bicyclists, no information for trail-roadway intersection crossing time has been available. Research was conducted on the Pinellas Trail to fill this gap.

Bicyclist crossing time from a full stop was measured using video taping equipment at 16 diverse intersections (two to six lanes, stop or signal controlled, divided or undivided) of the Pinellas Trail. A total of 443 bicyclists (single individuals or randomly selected individuals from a group) were timed. A linear regression model was fit to the time and crossing distance data (Figure 19). A linear regression model was also fit to eight 15th percentile data points which were calculated from the raw data.

Using kinematic physics, where bicycle acceleration and intersection crossing velocity are variables, an equation (3) (page 3-23) was derived (Appendix B) to predict bicyclist crossing time for any distance  $S$ . Since this derived equation is a linear function of distance, the regression coefficients could then be used to estimate bicyclist intersection crossing velocity and acceleration on the Pinellas Trail. Mean velocity,  $v_{50}$ , was found to be 12.7 km/h (7.9 mi/h) and mean acceleration,  $a_{50}$ , 1.07 m/s<sup>2</sup> (3.5 ft/s<sup>2</sup>). Similarly, the 15th percentile velocity,  $v_{15}$  = 10.8 km/h (6.7 mi/h), and acceleration  $a_{15}$  = 0.74 m/s<sup>2</sup> (2.4 ft/s<sup>2</sup>) were calculated.

# Sight distance

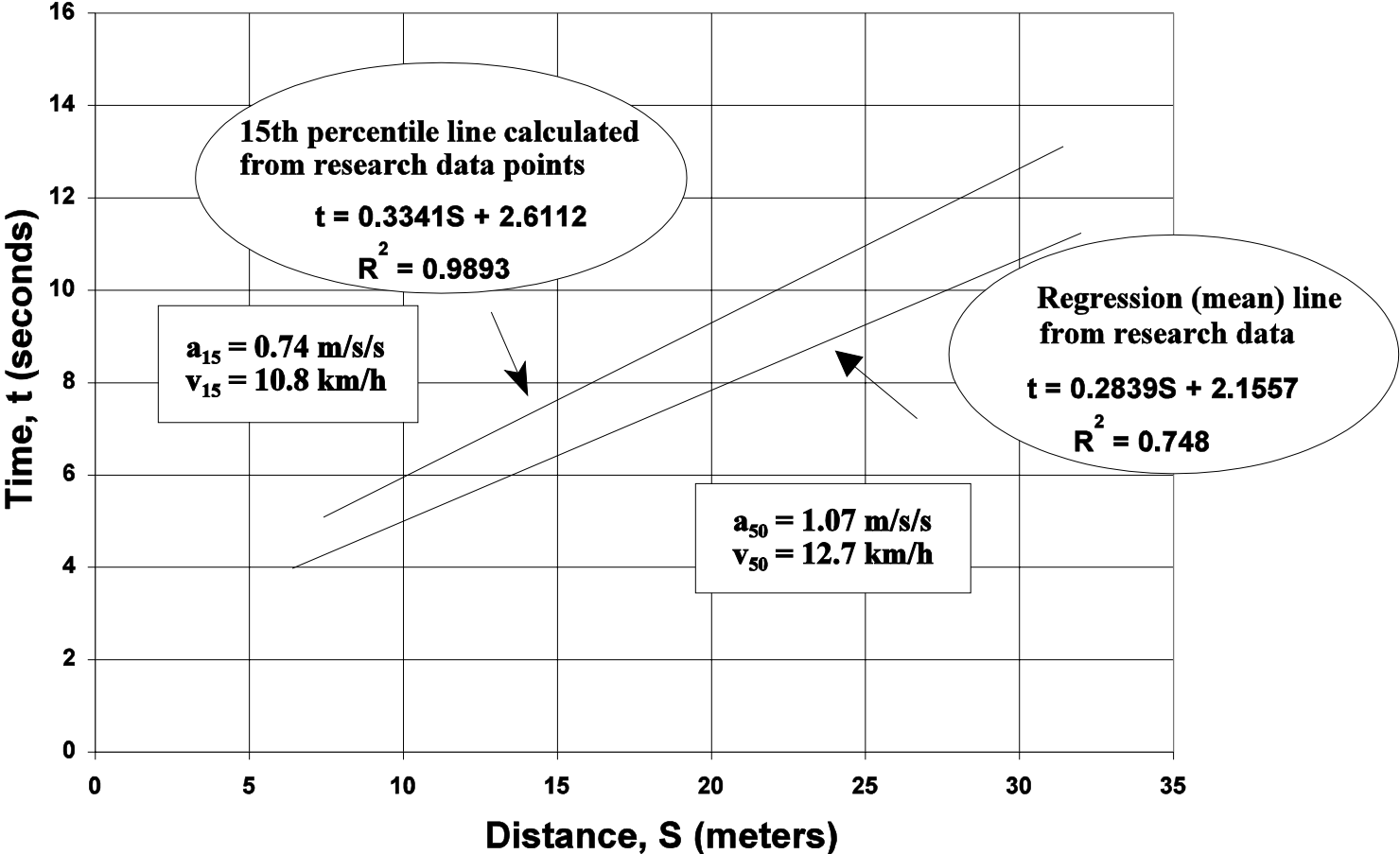

Figure 19. Bicyclist intersection crossing time as a function of distance, and mean and 15th percentile acceleration rates and crossing velocities on the Pinellas Trail.



# Sight distance

$$t = \left(\frac{1}{v}\right)S + \left(\frac{v}{2a} + \frac{1.8}{v}\right) \tag{3}$$

The 15th percentile values found on the Pinellas Trail,  $v = 10.8$  km/h (2.99 m/s; 6.7 mi/h) and  $a = 0.74$  m/s<sup>2</sup> (2.4 ft/s<sup>2</sup>), compare favorably to the values specified by the Dutch in *Sign Up For the Bike*, 10.0 km/h (6.2 mi/h) and 0.8 m/s<sup>2</sup> (2.6 ft/s<sup>2</sup>).

Using equation (3) with  $a = 0.74$  m/s<sup>2</sup> and  $v = 2.99$  m/s to determine crossing time for various crossing widths  $S$ , and then equation (2) (page 3-21), Table 8 gives bicyclist crossing sight distance values. A perception-reaction time of 2.5 seconds is also included.

Use of 15th percentile values for acceleration and crossing velocity when designing intersections for bicyclists is consistent with accepted transportation engineering practice of providing for the vast majority of roadway users. It can be argued, however, that it is improper to disregard the slowest of bicyclists. Perhaps choosing a more inclusionary percentile such as the 5th percentile would be prudent under certain circumstances. An additional 2 seconds of crossing time may also be added for every group of 5 users to account for delayed startup and friction.

Designers of multi-use trail-roadway intersections are also faced with accommodating the slowest of users—pedestrians.

**Table 8.** Bicyclist intersection crossing sight distance.

Crossing width (S); m	Crossing time (t); sec  (includes 2.5 sec p-r time)	Design speed		
		48 km/h (30 mi/h)	64 km/h (40mi/h)	80 km/h (50 mi/h)
		Crossing sight distance value (d); m		
5.0	6.8	91	122	152
6.0	7.1	95	127	159
7.0	7.4	99	132	166
8.0	7.8	105	140	175
9.0	8.1	109	145	181
10.0	8.5	114	152	190
11.0	8.8	118	158	197
12.0	9.1	122	163	204
13.0	9.5	127	170	213
14.0	9.8	132	176	220
15.0	10.1	136	181	226

(1m = 3.28 ft)

# Sight distance

**Pedestrians**

Since they are the slowest trail users, providing intersection sight distance for pedestrians encompasses the requirements of bicyclists (and skaters). Table 9 gives pedestrian intersection sight distance values.

**Table 9.** Pedestrian intersection crossing sight distance.

Crossing width (S); m	Crossing time (t); sec  (includes 3.0 sec p-r time)	Design speed		
		48 km/h (30 mi/h)	64 km/h (40mi/h)	80 km/h (50 mi/h)
		Crossing sight distance value (d); m		
5.0	7.7	104	138	173
6.0	8.6	116	154	193
7.0	9.6	129	172	215
8.0	10.5	141	188	235
9.0	11.4	153	204	255
10.0	12.4	167	222	278
11.0	13.3	179	238	298
12.0	14.2	191	254	318
13.0	15.2	204	272	341
14.0	16.1	216	289	361
15.0	17.1	230	306	383

(1m = 3.28 ft)

A walking rate of 1.07 m/s (3.5 ft/s) and a perception-reaction time of 3 seconds are assumed. As with bicyclists, an additional 2 seconds of crossing time may be added for each group of 5.

Because of their slow crossing speed, and/or other situational constraints (right-of-way; sight restrictions; wide road; high speed), it may be impossible to provide pedestrians with intersection sight distance. Pedestrians should then be accommodated by decreasing the crossing distance with a refuge area or bulbout, slowing the motor vehicles, or providing signalization.

**Decision sight distance**

As traditionally applied to motorists, decision sight distance provides additional protection beyond the minimum afforded by stopping sight distance. It is defined as “the distance required for a driver to detect an unexpected or otherwise difficult-to-perceive information source or hazard in the roadway environment that may be visually cluttered, recognize the hazard or its threat potential, select the appropriate speed and path, and initiate and complete the required safety maneuver safely and efficiently.”

A trail crossing, often an unusual encounter for drivers, seems to be an ideal location to provide motorists with additional sight distance. This can be done by increasing the standard perception-reaction time value of 2.5 seconds for motorists’ stopping sight distance or by using the most appropriate

# Sight distance

decision sight distance value from Table III-3 in the Green Book, though none of these specifically address trail crossings.

Decision sight distance may also be applied to bicyclists, but differs in concept from the motorist-based application. For bicyclists, it involves providing clear sight lines that are based on the distances that approaching motor vehicles will travel in the amount of time a bicyclist takes to fully clear the intersection from a “stop-go” decision point<sup>29</sup> (Figure 20).

From this decision point, located at the stopping sight distance from the pavement edge, a bicyclist must be able to see any conflicting motor vehicle prior to making the choice to stop or proceed without stopping, irrespective of the presence of a stop sign or signal. This concept acknowledges bicyclists’ desire to maintain momentum, and may be used to provide a measure of safety where bicyclists are known to generally not fully stop where required.

A trail design speed of 32 km/h (8.9 m/s; 20 mi/h) yields from equation (1) on page 3-20 a minimum stopping sight distance requirement of 38.4 m (126 ft) at zero grade. Using this value, a bicyclist approach speed of 8.9 m/s, and calculating for decision sight distances X and Y, Table 10 results.

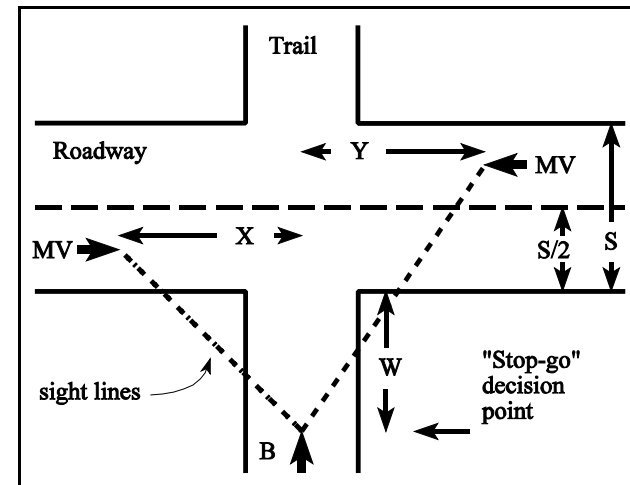

$$X = t_2 MV$$

$$Y = t_1 MV$$

$$t_2 = \frac{W + S/2 + 1.83}{B} = \text{time for near side lane(s) clearance; s}$$

$$t_1 = \frac{W + S + 1.83}{B} = \text{time for full intersection clearance; s}$$

W = bicyclist stopping sight distance; m

S = width of crossing; m

1.83 = length of bicycle; m

B = approach speed of bicyclists; m/s

MV = approach speed of motor vehicles; m/s

**Figure 20.** Bicyclist decision sight distance.

# Sight distance

**Table 10.** Bicyclist decision sight distance values.

Crossing length (S); m	Motor vehicle approach speed (85th percentile)		
	48 km/h 30 mi/h 13.4 m/s	64 km/h 40 mi/h 17.9 m/s	81 km/h 50 mi/h 22.4 m/s
	Sight distance X/Y value; m		
5.0	64 / 68	86 / 91	107 / 113
6.0	65 / 69	87 / 93	108 / 116
7.0	66 / 71	88 / 95	110 / 118
8.0	66 / 72	89 / 97	111 / 121
9.0	67 / 74	90 / 99	112 / 123
10.0	68 / 75	91 / 101	113 / 126
11.0	69 / 77	92 / 103	115 / 128
12.0	69 / 78	93 / 105	116 / 131
13.0	70 / 80	94 / 107	117 / 133
14.0	71 / 81	95 / 109	118 / 136
15.0	72 / 83	96 / 111	120 / 138

(1m = 3.28 ft)

The Finns have also developed guidelines that address the issue of bicyclists maintaining momentum. Their sight distance requirements are shown in Figure 21. In the “good” class a bicyclist traveling at 20 km/h (12.4 mi/h), and in the

“satisfactory” class traveling at 10 km/h (6.2 mi/h), is able to see a motor vehicle along the appropriate sight line defined by distance d, adjust speed to the point of almost stopping prior to reaching the roadway, and then cross the 8 m wide road once the motor vehicle has crossed the intersection. In the “poor” class the bicyclist always has to stop.

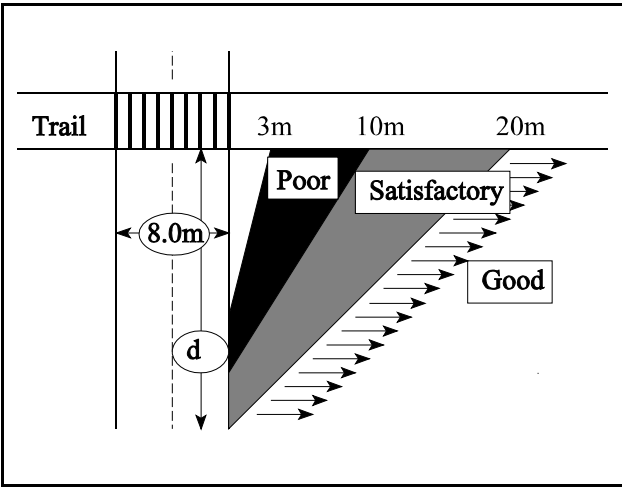

Standard	d for motor vehicles	
	50 km/h	60 km/h
Good	110m	140m
Satisfactory	85m	110m

**Figure 21.** Sight distance standards in Finland. (1m = 3.28 ft)

# Refuge areas

Refuge areas are areas within a trail-roadway intersection where trail users can wait in relative safety until motor vehicle traffic clears. They typically are a median—existing or artificially created—between opposing lanes of traffic, and may be a cut-thru at pavement level of a raised area, a raised island area with curb ramps or, least desirably, an unprotected paint-delineated area at pavement level.

Refuge areas can be beneficial by:

- ▶ enhancing safety by separating conflicts and allowing the trail-user to look for traffic in one direction at a time— when crossing to the refuge and from the refuge to the far side;
- ▶ reducing trail-user delay and clearance interval by enabling the crossing of one direction of traffic during each interval;
- ▶ providing a resting place, storage, and protection for trail-users;
- ▶ functioning as a traffic calming technique;
- ▶ providing a location for traffic control devices. (*Author's Note: Care should be taken to not obstruct the view of the trail user*).

## Placement

The recommended practice of the Institute of Transportation Engineers entitled *Design and Safety of Pedestrian Facilities*<sup>31</sup> concludes that refuge areas are best used:

- ▶ on wide streets (4 or more lanes) with high traffic volume and speed;
- ▶ on streets with insufficient green signal phasing time for safe crossing.

This same publication notes that special consideration should be given to situations at which many children, elderly, or disabled individuals are present. A trail crossing may certainly also fit this special consideration criterion.

The ITE also notes that refuge areas are least beneficial or possibly detrimental:

- ▶ on narrow streets;
- ▶ where their width is substandard;
- ▶ under conditions at which the roadway alignment obscures the island from the motorist;
- ▶ in areas where snow plowing will be hampered.

Any potential disadvantage to motorists must be weighed against the benefits to trail users.

Dunn concluded that a refuge area should be provided if the roadway width exceeds 10 m (33 ft) based on the evidence that pedestrians reject headways of less than four seconds and using

## Refuge areas

an average walking speed of 1.2 m/s (4 ft/s).<sup>32</sup> The Finns specify a refuge area on roadways of three or more lanes.

To be utilized by trail users, a refuge area must be first perceived, and then regarded as offering adequate protection.

The two pictures to the right are different views—the motorists' and the trail users'—of the Pinellas Trail crossing Tilden Street. As can easily be seen from the motorists' view, there is a painted median that can serve as a refuge area.

The trail users' view shows the difficulty in perceiving an unprotected, at-grade refuge area. A raised median would not only help eliminate this perception problem, but would also provide tangible physical protection to otherwise timid trail users.

In two three-hour periods at this intersection, a total of 195 individual or group trail crossings were made. One hundred sixty two (83%) crossed the entire roadway in one maneuver, and 22 (11%) used the refuge area to assist with the crossing. Eleven (6%) *could* have used the refuge area to cross half way, but elected not to (these trail users rejected a 6 second or greater gap in traffic in their first half of the road).



Motorists' view.



Trail users' view.

# Refuge areas

## Specifications

Figure 22 is a composite from Finland and the U.S.

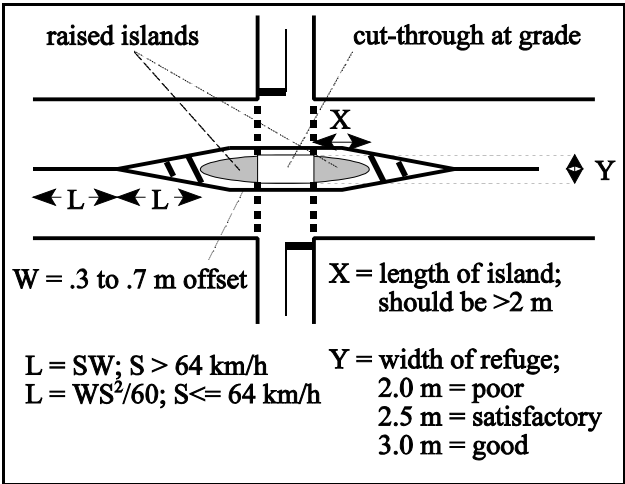

**Figure 22.** Specifications for a created refuge area. (1 m = 3.28 ft; 1 km/h = .62 mi/h)

The obstruction markings are from Figure 3-13 on page 3B-19 of the *MUTCD*. The speed of the motor vehicles, *S*, is the 85th percentile speed. The minimum length of *L* is specified as 30 m (100ft) in urban areas and 61 m (200 ft) in rural areas.

The Finns have provided the dimensions (*X*, *Y*) of the raised island. Given that the length of a standard bicycle is 1.8 m (5.9 ft), it is reasonable to require a minimum width of 2.0 m

(6.6 ft), with 3.0 m (9.8 ft) preferred. The length should be greater than 2 m (6.6 ft).

If sufficient trail right-of-way permits opposite sides of the trail across a roadway to be slightly offset, the median refuge area may be angled 75 degrees in order to turn the trail user toward the approaching motor vehicle traffic to aid visual searching. This design requires a minimum refuge area width of 3.7 m (12 ft), a refuge area center line, and the STOP or YIELD pavement marking as appropriate in the refuge area (Figure 23).

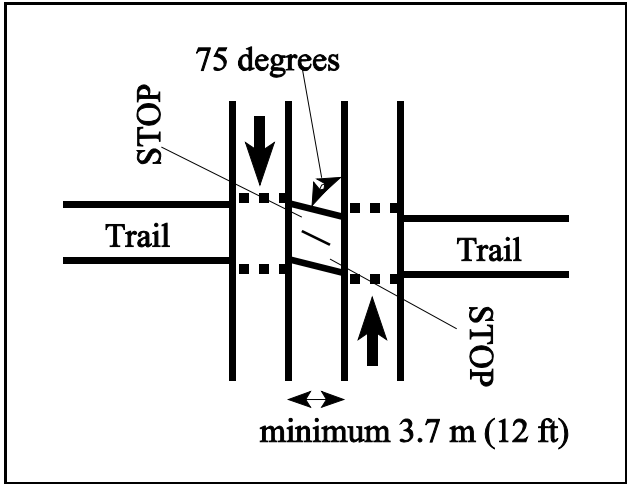

**Figure 23.** Angled refuge area.

# Refuge areas

Figure 24 depicts the situation at which it is desirable to provide additional storage for trail users in the roadway median. This design necessitates stop signs on the median in addition to the normal location at roadway edge.

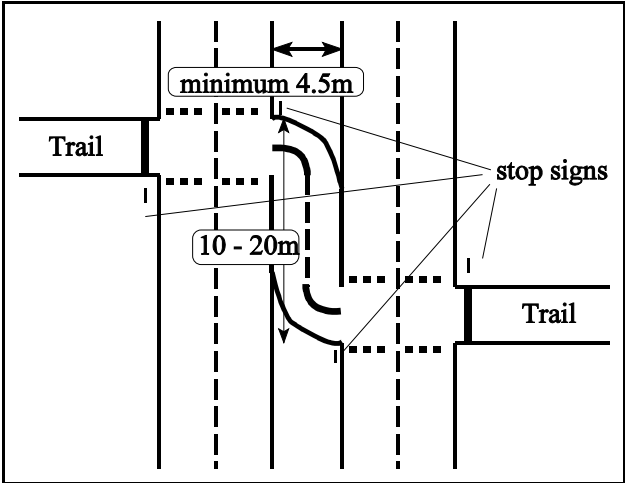

**Figure 24.** Refuge area in median with extended storage. (1 m = 3.28 ft)



## Additional considerations

### Access control

Access control devices should not be routinely installed at all roadway crossings. Rather, they should be used only if there is a demonstrated need to prevent unauthorized motor vehicle entry onto the trail. In urban areas, a high volume of trail users will likely effectively deter unauthorized use of the trail.

The hazard they create is greater than the problem they are trying to solve.

*Trails for the Twenty First Century*

Restrictive access control devices such as “cattle guards” or dismount barriers should generally not be used except under very special circumstances.

A secondary benefit of access control devices is to alert the trail user to the presence of the intersection. They should not be used to force trail users to slow down or stop. Care must also be taken to not force a trail user to slow before clearing the crossed roadway.

Regulatory sign R5-3, No Motor Vehicles, may be placed to prohibit this traffic.

### Bollards

Bollards (barrier posts) are the most frequently used method of controlling motor vehicle access to multi-use trails; however, they are a hazard to bicyclists, divert bicyclists’ attention away from traffic, can present problems for emergency and maintenance vehicles, and can be a bothersome expense in urban areas where there are frequent road crossings.

If bollards are to be used, the following installation guidelines are recommended in *Trails for the Twenty First Century*:

- ▶ bright color and reflectorization for day and night visibility;
- ▶ at least .9 m (3 ft) tall;
- ▶ removable for emergency and maintenance access;
- ▶ setback a minimum of 3 m (10 ft) from the intersection to allow negotiating space;
- ▶ always use one or three, never two bollards, to ensure proper channelization of trail users;
- ▶ where three bollards are used, they should be spaced a minimum of 1.5 m (5 ft) apart.

The *Technical Handbook of Bikeway Design* recommends:

- ▶ minimum height of 1.2 meters (3.9 ft);
- ▶ starting from the top, there must be five black horizontal stripes 56 mm (2.2 in) wide alternating with four yellow reflectorized stripes 80 mm (3.1 in) wide that have a reflectivity at least equal to Grade II of BNQ Standard 6830-101.

It is recommended that yellow reflectorized stripes be used on bollards separating opposing traffic and white on any others.

# Additional considerations

Bollards also must have obstruction striping—yellow when separating opposing traffic, white for same direction. The minimum arrangement is shown in Figure 25.

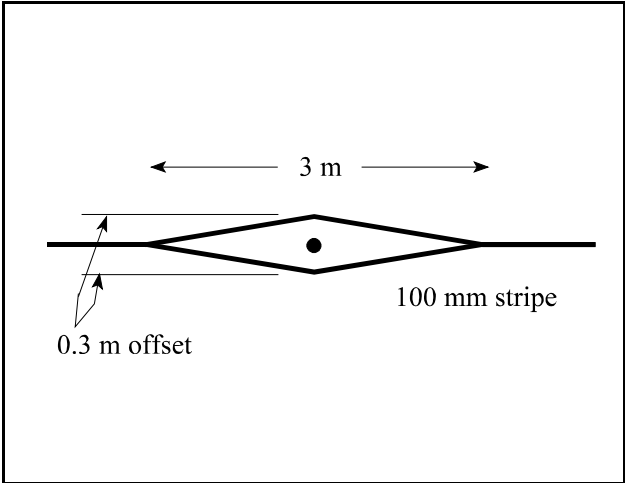

**Figure 25.** Barrier post obstruction marking. (1m = 3.28 ft)

Page 3B-19 of the *MUTCD* gives approach markings dimensions for obstructions in the roadway to motor vehicles. These same principles apply on trails using a bicyclist 85th percentile speed of 22 km/h (13.6 mi/h).

### Lean rails

A lean rail is a structure placed parallel to the trail that functions similarly to a bollard, but provides additional benefits beyond access control. This device enables bicyclists to keep their feet on the pedals when stopped, and can also serve as an

emergency grab rail for novice skaters who may have difficulty stopping. The rail should be steel for durability, 1.1 m (3.6 ft) high, and 2.5 m (8.2 ft) long. The installation guidelines for bollards apply also to lean rails.

### Median

Another method of restricting unauthorized motor vehicle entry is to split the trail with a median into two sections with a minimum width of 1.5 m (5 ft) each. The median area should be a maximum 1m (3.3 ft) wide to allow emergency vehicle straddling, a minimum of 2 m (6.6 ft) long, and setback a minimum of 3 m (10 ft) from the roadway edge to give trail users negotiating space. It can be landscaped with low vegetation to produce an attractive entranceway (Figure 26).

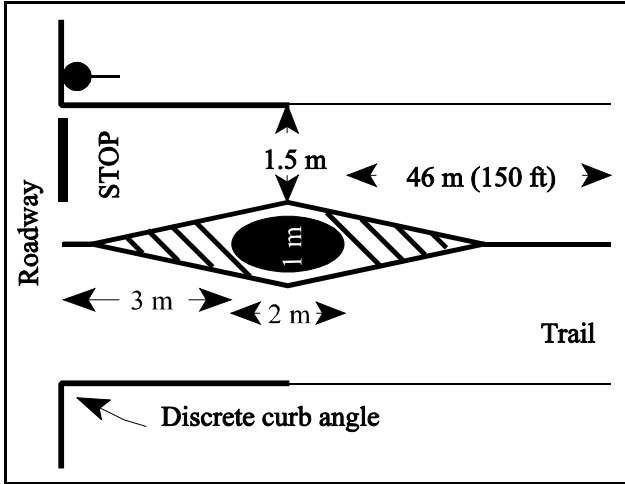

**Figure 26.** Median and discrete curb angle access control. (1m = 3.28 ft)

## Additional considerations

A median is also very effective for channelizing trail users, and for this reason may be especially useful on high volume trails.

### Discrete Curb Angles

By providing 90 degree angles and sharply defined curbing, motor vehicle entry is discouraged. A potential intruder would be forced to negotiate a wide turning radius in order to gain entry to the trail. This method of restricting unauthorized access is also shown in Figure 26.

### Pavement markings

Markings on multi-use trails are intended to channelize trail users to reduce the risk of collisions and to warn them of obstacles or other hazards. Yellow should be used when separating opposing traffic and white for same direction traffic.

At a minimum, a yellow center line (or combined advance warning striping and center line if a bollard, lean rail, or median obstruction is present) 46 m (150 ft) long should be painted on the approach to the intersection. This warns trail users of the impending intersection and channelizes users to help avoid conflicts when negotiating the roadway intersection. As specified in section 3B-20 of the *MUTCD*, the regulatory pavement marking STOP may be used in conjunction with a stop bar and sign. This may be particularly appropriate for a trail because of bicyclists' typical head down position, though the center line as noted above should be adequate advance warning to stimulate search behavior.

If the trail is marked with separate pedestrian and bicyclist areas, these may be continued up to the intersection or else merged at least 50 meters in advance of the intersection. Where they are kept separated, a divided crosswalk is a concept that can be used to help channelize the user groups within the intersection (Figure 27).

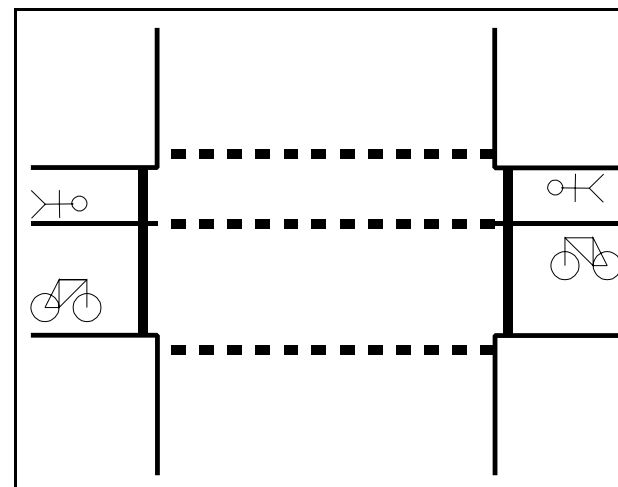

Figure 27. Divided crosswalk.

All trail pavement markings, including roadway crosswalks, must be highly visible, skid resistant, and durable. Thermoplastic should not be used for longitudinal striping along the trail because the raised surface is a hazard to bicyclists and skaters. Its use for transverse striping is a tripping hazard to skaters.

## Additional considerations

### Crosswalk striping

Typical crosswalk marking patterns are shown in Figure 28.

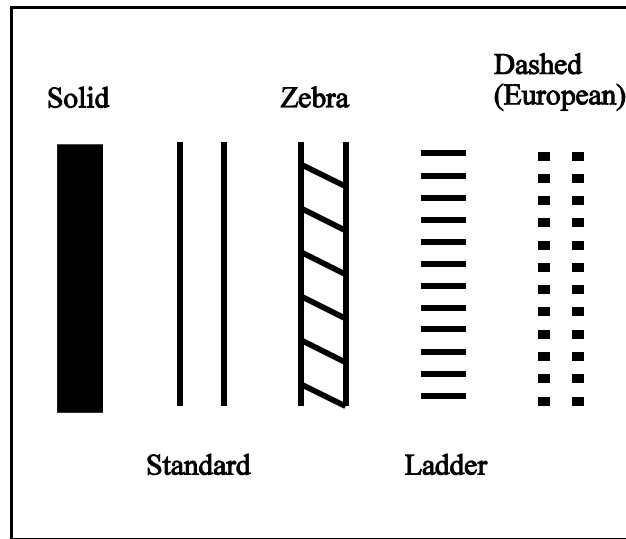

**Figure 28.** Crosswalk patterns.

Section 3B-18 of the *MUTCD* provides guidelines for crosswalk placement. It is recommended that all trail crossings have crosswalk markings.

There is no conclusive evidence that a particular design will provide safer conditions. Most of the crosswalks shown in this manual depict the “Dashed” striping pattern.

#### More paint = More protection?

Although it has not been substantiated, it may be that the greater the amount of paint, the greater the perceived protection on the part of the pedestrian and the stronger the message to motorists of the presence and influence of pedestrians. Thus, it may be applicable for future use to install the heavier paint “ladder” pattern on lower speed and volume roads and the minimal paint “dashed” pattern on higher speed and volume roads. This is a topic requiring further research.

#### Stop Lines

Stop lines are solid transverse white lines, normally 30 - 61 mm (12 - 24 in) wide. They are used to indicate to motorists the optimal stopping point and may be helpful in preventing encroachment into crosswalks. However, stop lines are not necessary at most marked crosswalks, and the use of a wider crosswalk may be useful in lieu of a stop line.

When used, they should be installed 1.2 m (4 ft) in advance of the crosswalk, although some jurisdictions have used them further in advance in an attempt to improve visibility and lessen the chance of a “multiple threat” type collision (Figures 29 and 30).

# Additional considerations

With the stop line setback as in Figure 30, the bicyclist—in the same position—and the moving motorist have an unobstructed view of each other.

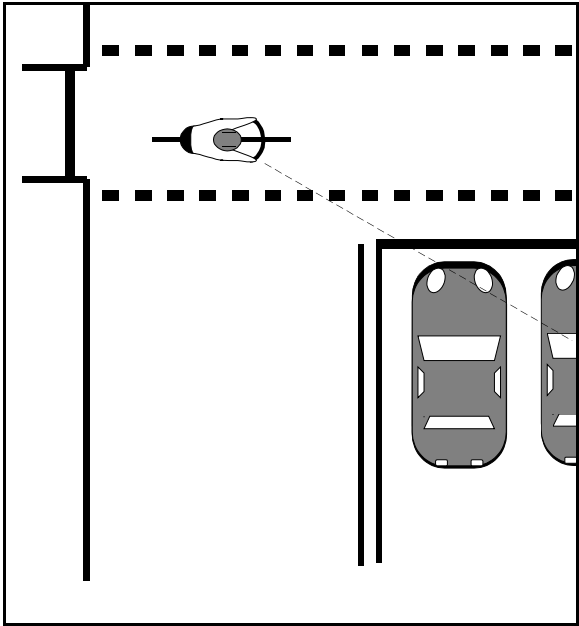

**Figure 29.** Obstructed visibility with stop line close to crosswalk.

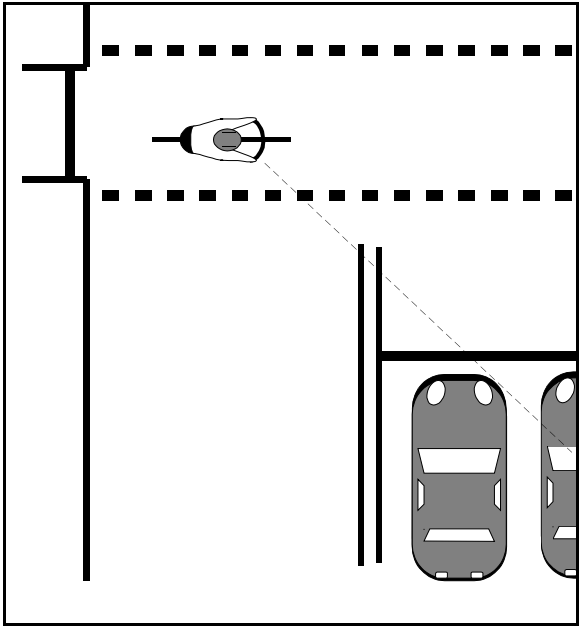

**Figure 30.** Increased visibility with setback stop line.

# Additional considerations

## Texture change

A surface texture change may be used to warn trail users of an approaching intersection. *Trails For The Twenty First Century* notes that an 46 mm (18 in) wide concrete strip can be inlaid into the asphalt across the trail 9 m (30 ft) from the intersection. A raised thermoplastic strip may be a cost-effective means of achieving similar results.

Where used on the Pinellas Trail, a concrete strip 1.5 m (5 ft) wide is located 24 m (80 ft) from the roadway edge.

The benefits of a texture change must be weighed against its additional cost and, more importantly, the tripping hazard it causes skaters.

## Lighting

From the *Technical Handbook of Bikeway Design*, trail horizontal and vertical illumination levels are shown in Table 11.

**Table 11.** Multi-use trail illumination levels in Canada.

Location	Illumination type	Lux min./avg.	Uniformity ratio
Multi-use trail	Horizontal	1/3	10/1
	Vertical	1/3	10/1
Intersection with unlit street	Horizontal	1/3	5/1
	Vertical	2/5	5/1
Intersection with lighted street	Horizontal	1/3	3/1
	Vertical	2/5	3/1

In the approach to an intersection, the trail must be illuminated at least as brightly as the crossed street for a distance of 25 meters (82 ft) on either side of the intersection. Transitional lighting must be installed on an unlit street crossed by the trail to enable motorists to adjust to the illumination level. The handbook specifies that the length of this transition zone depends on the speed limit on the street. It may be advisable to use the 85th percentile speed instead, however.

## Additional considerations

### Curb cuts

The bottom of the curb cut should match the gutter grade and not have an elevated lip at the asphalt seam. The bottom width of the curb cut should be the full width of the crosswalk and trail, with special care taken to ensure that hazardous curb ledges are not created at the outside edges of the trail (Figure 31).

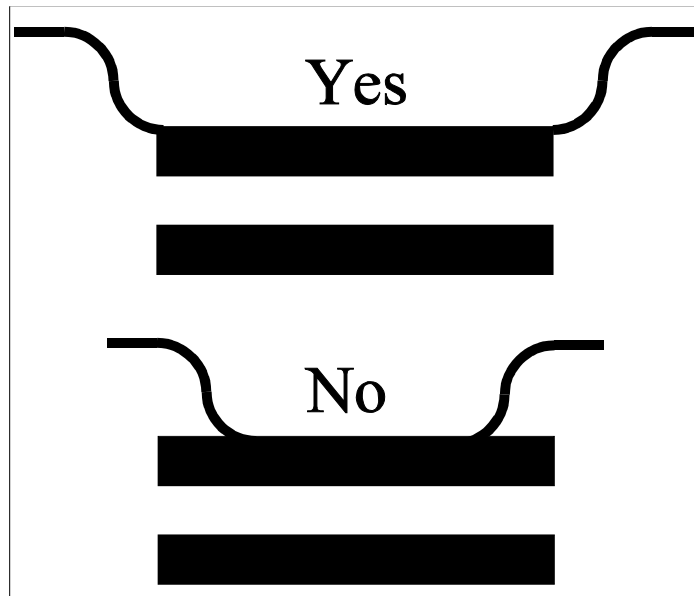

Figure 31. Curb cut width.

# References

---

1. Florida Greenways Commission, Creating a Statewide Greenways System. Report to the Governor. December 1994.
2. The Redland Conservancy, South Dade Greenway Network Master Plan. Dade County, Florida. 1994.
3. William W. Hunter, Jane C. Stutts, Wayne E. Pein, and Chante L. Cox. "Pedestrian and Bicycle Crash Types of the Early 1990's," University of North Carolina Highway Safety Research Center. Report for the Federal Highway Administration, U.S. Department of Transportation. February 1995.
4. Alan Wachtel and Diana Lewiston, "Risk Factors for Bicycle-Motor Vehicle Collisions at Intersections," ITE Journal (September 1994): 30-35.
5. Michael R. Hill, "Social/Behavioral Science Contributions to Our Understanding of the Pedestrian Experience: A Brief Review," in Our Best Foot Forward, Proceedings of the Florida Pedestrian Conference, April 27, 1987, 30-40.
6. Finnish National Road Administration, Main Roads In Urban Areas, Bikes and Pedestrians. Helsinki, Finland. 1991.
7. Center for Research and Contract Standardization in Civil and Traffic Engineering, Sign Up For The Bike, Design Manual For a Cycle-friendly Infrastructure. The Netherlands. 1993.
8. Sustrans Limited, Making Ways for the Bicycle. Bristol, Britain. 1994.
9. Velo Quebec, Technical Handbook of Bikeway Design. Canada. 1992.
10. G. Gittings, D.J. Torbic, and L.A. Zangwill. "Project Task 16: Evaluation of Issues In Planning And Design of Bicycle Trail-Highway Crossing." PennDOT/MAUTC Partnership Agreement No. 250056. The Pennsylvania Transportation Institute, The Pennsylvania State University. December 1994.
11. Rails-to-Trails Conservancy, Kathy-Lee Ryan, ed., Trails for the Twenty First Century. Washington, D.C.: Island Press. 1993.
12. C.A. Flink and R.M. Searns, Greenways: A Guide to Planning, Design, and Development. Washington, D.C.: Island Press. 1993.
13. Federal Highway Administration, Manual on Uniform Traffic Control Devices. 1988.



# References

---

14. Federal Highway Administration, Traffic Control Devices Handbook. 1988.
15. American Association of State Highway and Transportation Officials, A Policy on Geometric Design of Highways and Streets. 1994.
16. American Association of State Highway and Transportation Officials, Guide for the Development of Bicycle Facilities. Washington, D.C. 1991.
17. ITE Technical Council Committee 5A-5, Institute of Transportation Engineers, Design and Safety of Pedestrian Facilities. Washington, D.C. 1995.
18. Florida State Safety Office, State Bicycle/Pedestrian Program, Florida Bicycle Facilities Planning and Design Manual Tallahassee: Department of Transportation. 1996.
19. Richard L. Knoblauch, Marsha Nitzburg, Robert Dewar, John Templer, and Martin Pietrucha, Older Pedestrian Characteristics for Use in Highway Design. FHWA contract No. DTFH61-91-C-00028. 1993.
20. Institute of Transportation Engineers, Manual of Transportation Engineering Studies. 1994.
21. S. Sandels, Children in Traffic. London: Paul Elek. 1975.
22. J.A. Michon, "Traffic Education for Young Pedestrians: An Introduction," Accident Analysis and Prevention, Vol. 13, No. 3, (1981): 163-167.
23. A. W. Zelinka II, "Understanding Communities Through Youths and Seniors," in the proceedings of the "I Can't Get There from Here!" conference held at the University of Florida Nov 30-Dec 4, 1992, 47-56.
24. Center for Urban Transportation Research, College of Engineering, University of South Florida, Demographic & Commuting Trends in Florida, (1994).

# References

---

25. SWOV Institute for Road Safety Research, "Research within the framework of the Dutch 'Master Plan Fiets'," in proceedings of the international conference Strategic Highway Research Program and Traffic Safety on Two Continents, The Hague, September 22-24, 1993, 2260 AD Leidschendam, The Netherlands.
26. Michael J. Wallwork and Theodore A. Petritsch, "Designing Pedestrian Friendly Intersections," in proceedings of "I Can't Get There from Here!" conference at the University of Florida, November 30-December 4, 1992, 13-24.
27. Stephen H. Kaiser, "Urban Intersections that Work For Pedestrians: A New Definition for Level Of Service," (Washington, D.C. January 1994), paper presented at the 73rd annual meeting of the Transportation Research Board.
28. Kenneth S. Opiela, Snehamay Khasnabis, and Tapan K. Datta, "Determination of the Characteristics of Bicycle Traffic at Urban Intersections," Transportation Research Record 743, Pedestrian Behavior and Bicycle Traffic, (1980): 30-38.
29. D.T. Smith, Safety and Locational Criteria for Bicycle Facilities, Federal Highway Administration, FHWA-RD-75-112. October 1975.
30. Institute of Transportation Engineers, Technical Council Committee 5A-5, Design and Safety of Pedestrian Facilities, Washington, D.C. 1994.
31. Ryan R. Forrestel, "Pedestrian Refuge Islands," Design and Safety of Pedestrian Facilities, ITE Technical Council Committee 5A-5 December 1994, 33-34.
32. Roger C. Dunn, "Unsignalized Pedestrian Crossings: New Zealand's Technical Recommendations," ITE Journal, 59, No. 9, (September 1989).