

- 1515.01 General
- 1515.02 Shared-Use Path Design
- 1515.03 Intersections and Crossings Design
- 1515.04 Grade Separation Structures
- 1515.05 Signing, Pavement Markings, and Illumination
- 1515.06 Restricted Use Controls
- 1515.07 Documentation

## 1515.01 General

Shared-use paths are designed for both transportation and recreation purposes and are used by pedestrians, bicyclists, skaters, equestrians, and other users. Some common locations for shared-use paths are along rivers, streams, ocean beachfronts, canals, utility rights of way, and abandoned railroad rights of way; within college campuses; and within and between parks as well as within existing roadway corridors. A common application is to use shared-use paths to close gaps in bicycle networks. There might also be situations where such facilities can be provided as part of planned developments. Where a shared-use path is designed to parallel a roadway, provide a separation between the path and the vehicular traveled way in accordance with this chapter.

As with any roadway project, shared-use path projects need to fit into the context of a multimodal community. Exhibits are provided throughout this chapter to illustrate possible design solutions, which should be treated with appropriate flexibility as long as doing so complies with corresponding laws, regulations, standards, and guidance. Engage various discipline experts, including landscape architects, soil and pavement engineers, maintenance staff, traffic control experts, ADA and bicycle coordinators, and others. Additionally, when designing such facilities, consider way-finding.

This chapter includes technical provisions for making shared-use paths accessible to persons with disabilities. Design shared-use paths and roadway crossings in consultation with your region's ADA Coordinator, Bicycle Coordinator, and State Bicycle and Pedestrian Coordinator. For additional information on pedestrian and bicycle facilities, see Chapters 1510 and 1520, respectively.

## 1515.02 Shared-Use Path Design

When designing shared-use paths, the bicyclist may not be the critical design user for every element of design. For example, the crossing speeds of most intersections between roads and pathways should be designed for pedestrians, as they are the slowest users. Accommodate all intended users, and minimize conflicts. When designing to serve equestrians, it is desirable to provide a separate bridle trail along the shared-use path to minimize conflicts with horses.

## Exhibit 1515 - 1 Shared-Use Path

**1515.02(1) Design Speed**

The design speed for a shared-use path is based on bicycle use and is dependent on the terrain and the expected conditions of use. Design the shared-use path to encourage bicyclists to operate at speeds compatible with other users. Higher speeds are discouraged in a mixed-use setting. Design shared-use paths to maintain speeds at or below the speeds shown in Exhibit 1515-2 by designing to the horizontal curve radii shown.

## Exhibit 1515 - 2 Bicycle Design Speeds

Conditions	Design Speed (mph)	Curve Radius (ft)
Long downgrades (steeper than 4% and longer than 500 ft)	30	166
Open country (level or rolling); shared-use paths in urban areas	20	74
Approaching intersections	12	27

When minimum radius curves cannot be obtained because of right of way, topographical, or other constraints, consider installing the following mitigation measures for traffic calming to slow bicyclists when approaching curves:

- Intermittent curves to slow or maintain desired speeds.
- Standard curve warning signs and supplemental pavement markings in accordance with the [MUTCD](#).

- Perpendicular stripes painted on the pathway in decreasing intervals to provide the perception of increased speed. This has been shown to slow drivers when applied to roadways.
- Changes in pavement texture to encourage reductions in speed at tight curve approaches.

The negative effects of tight radius curves can also be partially offset by widening the pavement through the curves. Steeper vertical grades affect the running speed of bicycles. A shared-use path should be designed not to exceed 5%. Refer to 1515.04(3) for further guidance.

## **1515.02(2) Widths, Cross Slopes, Side Slopes, and Clearances**

### **1515.02(2)(a) Shared-Use Path Widths**

The appropriate paved width for a shared-use path depends on the context, volume, and mix of users. The desirable paved width of a shared-use path, excluding the shoulders on either side, is 12 feet. The minimum paved width, excluding the shoulders on either side, is 10 feet.

A paved width of more than 12 feet, excluding the shoulders on either side, may be appropriate when substantial use by both pedestrians and bicyclists is expected or maintenance vehicles are anticipated.

Shared-use path shoulders are typically unpaved and 2 feet wide on either side. Exhibits 1515-3 through 1515-5 provide additional information and cross-sectional elements.

On bridges or tunnels, it is common to pave the entire shared-use path, including shoulders. This usable width can be advantageous for emergency, patrol, and maintenance vehicles and allows for maneuvering around pedestrians and bicyclists who may have stopped. It also keeps the structure uncluttered of any loose gravel shoulder material.

### **1515.02(2)(b) Exceptions to Minimum Path Widths**

A reduced path width of 8 feet may be designed at locations that present a physical constraint such as an environmental feature or other obstacle. Refer to the [MUTCD](#) for signing and pavement markings for such conditions.

In very rare circumstances, a reduced width of 8 feet may be used where the following conditions prevail:

- Bicycle traffic is expected to be low, even on peak days or during peak hours.
- Pedestrian use of the facility is not expected to be more than occasional.
- Horizontal and vertical alignments provide frequent, well-designed passing and resting opportunities.
- The shared-use path will not be regularly subjected to maintenance vehicle loading conditions that would cause pavement edge damage.
- The share-use path is a short distance such as a spur connection to a neighborhood.

### 1515.02(2)(c) Existing Shared-Use Paths – Considerations

Some existing shared-use paths were constructed with narrower dimensions, generally providing 8 feet of pavement. Evaluate existing older paths for current needs. Consider widening an existing shared-use path to meet current geometric standards.

### 1515.02(2)(d) Cross Slope

The maximum cross slope on a paved shared-use path is to be 2%. The cross slope of the shoulders can be no steeper than 6H:1V. To accommodate drainage, the entire section, including shoulders, should transition through curves. It is desirable to design the pivot point on the outside edge of one side of the shoulder or the other to avoid a pavement crown (see Exhibits 1515-3 through 1515-5).

It is best practice to design the cross slope to be less steep than the allowed maximum to account for some tolerance in construction. For example, design for a 1.5% cross slope (rather than the 2% maximum).

Sloping the pavement surface to one side is desirable and usually simplifies drainage design and surface construction. Generally, surface drainage from the path is dissipated as it flows down the side slope.

### 1515.02(2)(e) Side Slopes and Pedestrian Rail

Side slopes along shared-use paths are an important design feature. Embankment side slopes of 6H:1V or flatter provide a gently sloping path border.

For shared-use paths with side slopes steeper than 3H:1V, or where obstacles or waterways may exist, evaluate the potential risk and provide mitigation such as:

- A minimum 5-foot separation from the edge of the pavement to the embankment edge. This can be accomplished by providing a 5-foot shoulder as shown in Exhibit 1515-5, Example 2.
- A natural barrier such as dense shrubbery on the side slopes.
- A physical barrier, such as a pedestrian rail.
- Where a shared-use path is adjacent to a vertical drop of 2 feet 6 inches or more, a pedestrian rail is needed (see Exhibit 1515-5, Example 4).
- If the vertical drop is less than 2 feet 6 inches, a pedestrian rail, chain link fence, or 4-inch curb at the edge of the shared-use path may be installed to delineate the edge.
- Where a shared-use path is constructed on the side of a hill, drainage facilities may need to be considered.

### 1515.02(2)(f) Clearances

The minimum horizontal clearance from the edge of pavement to an obstruction (such as bridge piers or guardrail) is 2 feet. For vertical clearances see 1515.04 Grade Separation Structures.

Exhibit 1515 - 3 Two-Way Shared-Use Path: Independent Alignment

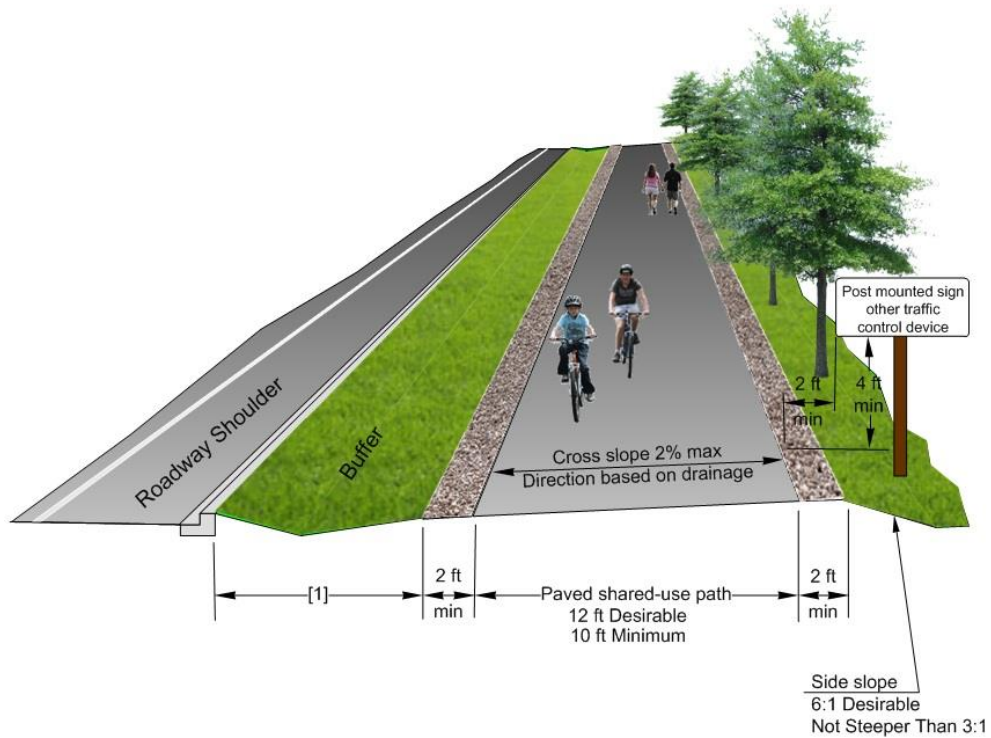
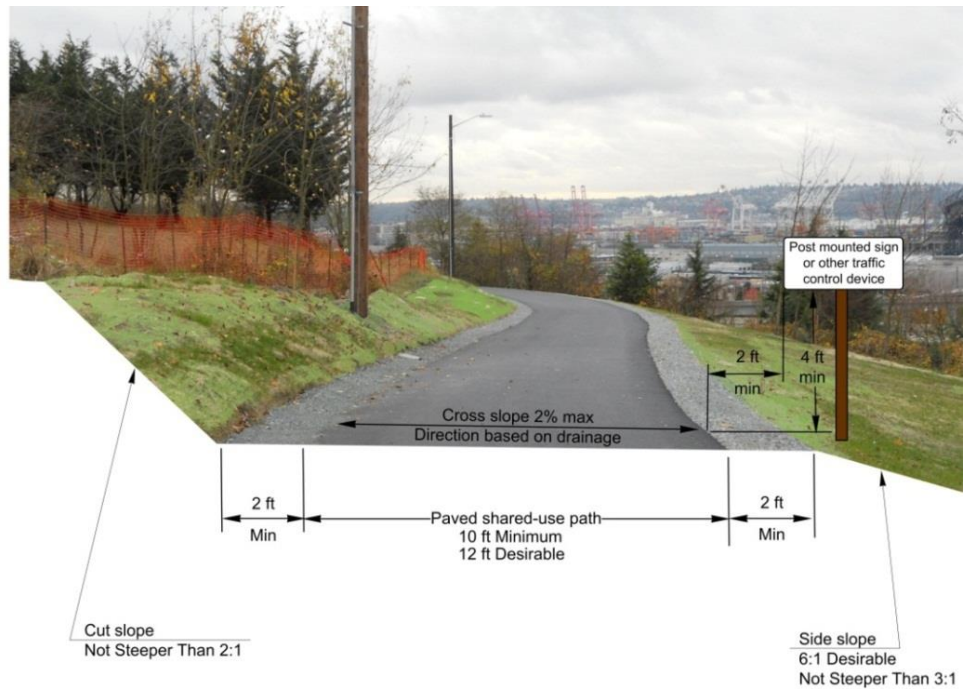

Note:

[1] 3 ft minimum. Provide as much separation from the roadway as practicable.



Exhibit 1515 - 4a Two-Way Shared-Use Path: Adjacent to Roadway (≤ 35 mph)

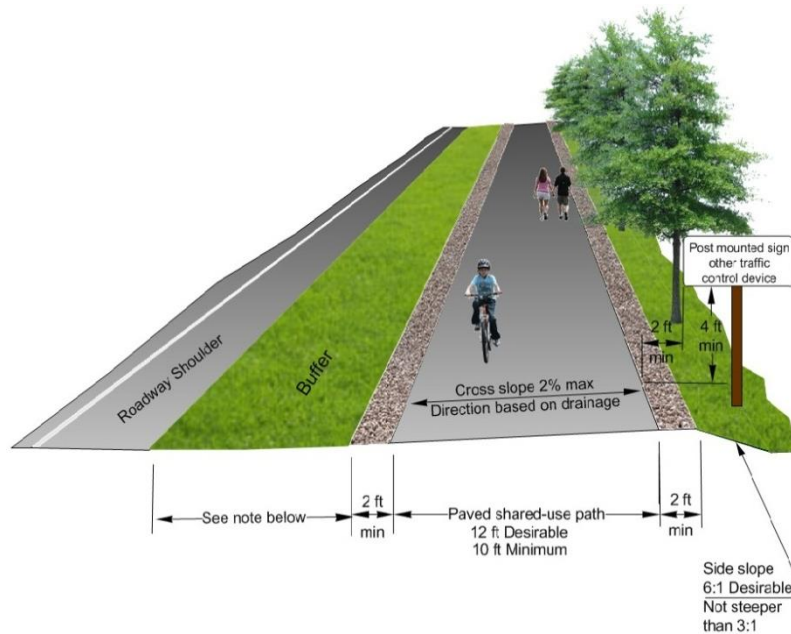

Notes:

A separation greater than 5 feet is required for path user comfort. If separation greater than 5 feet cannot be obtained, provide barrier separation in accordance with Exhibit 1515-4c.

See Chapter 1600 for roadway clear zone design guidance for fixed objects.

Exhibit 1515-4b Two-Way Shared-Use Path: Adjacent to Roadway (> 35mph)

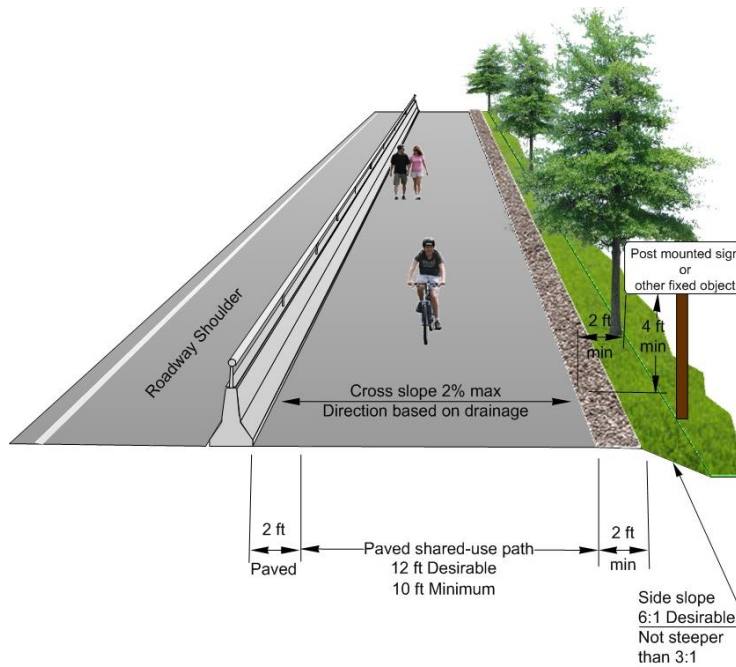

Notes:

It is desirable for the cross slope to slope toward grass areas for drainage.

See Chapter 1610 for barrier design. Pedestrian rail height minimum is 42 inches.

Exhibit 1515 - 5 Shared-Use Path Side Slopes and Railing

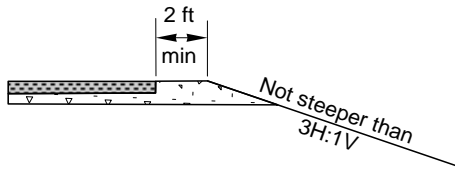

**Example 1: Embankment**

Based on context, flatter slopes are desirable.

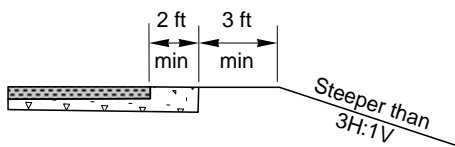

**Example 2: Shoulder widening to 5 feet or more**

Used with steeper fill slopes to provide clear space between the hinge point and path. Vegetation can also be used as a buffer on slopes. Consider a natural or physical barrier in lieu of 3 ft additional widening.

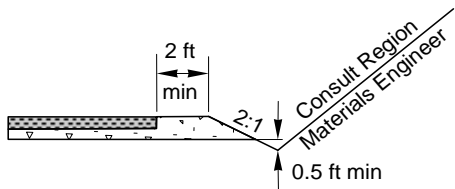

**Example 3: Cut section with ditch**

Consult with the Region Materials Engineer to determine for appropriate cut slopes.

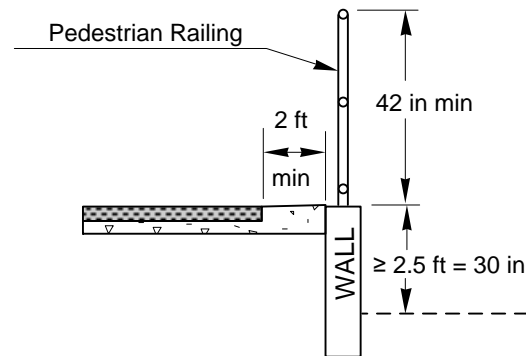

**Example 4: Railing used at drop off**

Apply railing or fencing a minimum of 42 inches high when a drop off is present, such as along a retaining wall. Consult with the Region Materials Engineer to determine if the shoulder along the wall should be paved.

Note: These drawings depict some common applications for various slope alternatives.

### 1515.02(3) Running Slopes, Landings, and Rest Areas

#### 1515.02(3)(a) Running Slopes

Design running slopes (grades) on shared-use paths less than or equal to 5% to accommodate all user types, including pedestrians with disabilities.

When the path is within the highway right of way, its running slope can match the general grade established for the adjacent roadway.

#### 1515.02(3)(b) Landings

Shared-use path landings provide users a level place to rest on extended grades. Exhibits 1515-6 and 1515-7 show these features.

Design landings to:

- Permit users to stop periodically and rest.
- Not exceed maximum running slopes and cross slopes of 2%.
- Be in line and as wide as the shared-use path. Landings are to be at least 5 feet long.
- Avoid abrupt grade changes or angle points. Design transitions to landings using vertical curves.

Exhibit 1515 - 6 Shared-Use Path Landing Profile

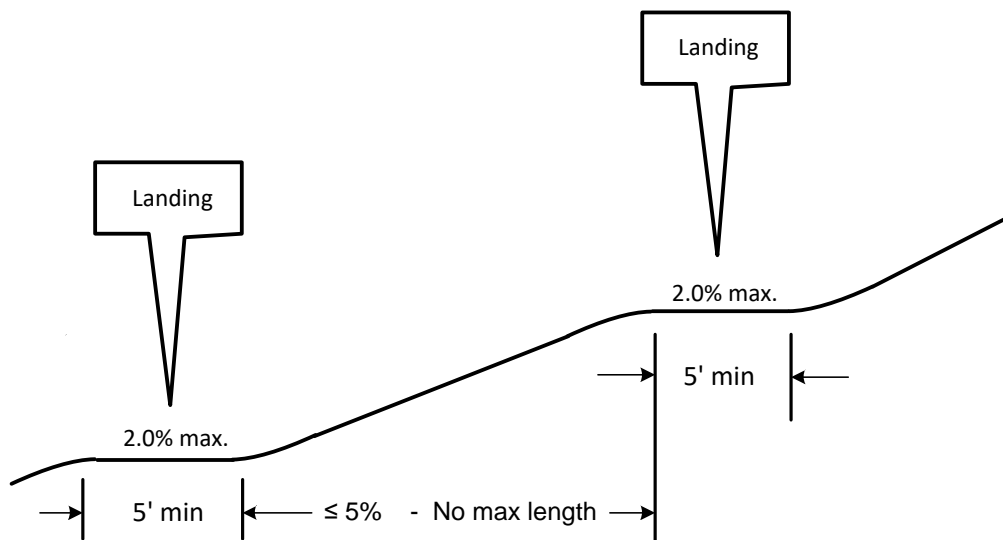

Notes:

Landings are desirable on extended grades.

Design vertical curves to transition from the grade to the landing.

Exhibit 1515-7 illustrates a landing and a rest area.



### 1515.02(3)(c) Rest Areas

Although not required, rest areas may be provided adjacent to the shared-use path outside of the path travelled way as shown in Exhibit 1515-7.

Requirements for rest areas include:

- The maximum running slope and cross slopes are 2%.
- The minimum size is to be 5 feet by 5 feet.
- If features such as benches are provided, they must meet ADA requirements; consult with the region ADA Coordinator for guidance.

### Exhibit 1515 - 7 Shared-Use Path Landing and Rest Area



Notes:

Design inline landings at least 5 feet long and as wide as the shared-use path.

Design inline landings with a maximum cross slope and running slope of 2%.

### 1515.02(4) Pavement Structural Section

Design the pavement structural section of a shared-use path in the same manner as a highway, considering the quality of the subgrade and the anticipated loads on the path. (Design loads are normally maintenance and emergency vehicles.) Provide a firm, stable, slip-resistant pavement surface.

Design the pavement structural section as recommended by the Region Materials Engineer.

Use crushed rock or other suitable material for shoulder graded areas as recommended by the Region Materials Engineer. On bridges or tunnels, it is common to pave the entire shared-use path, including shoulders across the structure.

### **1515.02(5) Stopping Sight Distance**

The distance needed to bring a shared-use path user to a complete stop is a function of the user's perception and braking reaction time, the initial speed, the coefficient of friction between the wheels and the pavement, the braking ability of the user's equipment, and the grade. Exhibits 1515-14a and 14b provide a graph and an equation to obtain minimum stopping sight distances for various design speeds and grades.

#### **1515.02(5)(a) Stopping Sight Distance on Crest Vertical Curves**

Exhibit 1515-15 provides a chart or equations to obtain the minimum lengths of crest vertical curves for varying stopping sight distances and algebraic differences in grade. The values are based on a 4.5-foot eye height for the bicyclist and a 0-foot height for the object (path surface).

#### **1515.02(5)(b) Stopping Sight Distance on Horizontal Curves**

Exhibit 1515-16 gives the minimum clearances to line-of-sight obstructions for sight distance on horizontal curves. Provide lateral clearance based on the sum of stopping sight distances from Exhibits 1515-14a and 14b for bicyclists traveling in both directions and the proposed horizontal curve radius. Where this minimum clearance cannot be obtained, provide curve warning signs and use centerline pavement markings in accordance with the [MUTCD](#).

Exhibits 1515-14a, 14b, 15, and 16 are presented at the end of the chapter.

## **1515.03 Intersections and Crossings Design**

This section covers path/roadway intersections and grade-separated crossings. Detectable warning surfaces are required where shared-use paths connect to the roadway.

### **1515.03(1) Intersections with Roadways**

Clearly define who has the right of way and provide sight distance for all users at shared-use path and roadway intersections.

The common types of shared-use path/roadway at-grade intersection crossings are midblock and adjacent.

For roadway intersections with roundabouts, see Chapter 1320.

**Midblock crossings** are located between roadway intersections. When possible, locate the path crossings far enough away from intersections to minimize conflicts between the path users and motor vehicle traffic. It is preferable for midblock path crossings to intersect the roadway at an angle as close to perpendicular as practicable. A minimum 60-degree crossing angle is acceptable to minimize right of way needs. A diagonal midblock crossing can be altered as shown in Exhibit 1515-8.

There are other considerations when designing midblock crossings. They include traffic right of way assignments; traffic control devices; sight distances for both bicyclists and motor vehicle operators; refuge island use; access control; and pavement markings.

### Exhibit 1515 - 8 Typical Redesign of a Diagonal Midblock Crossing

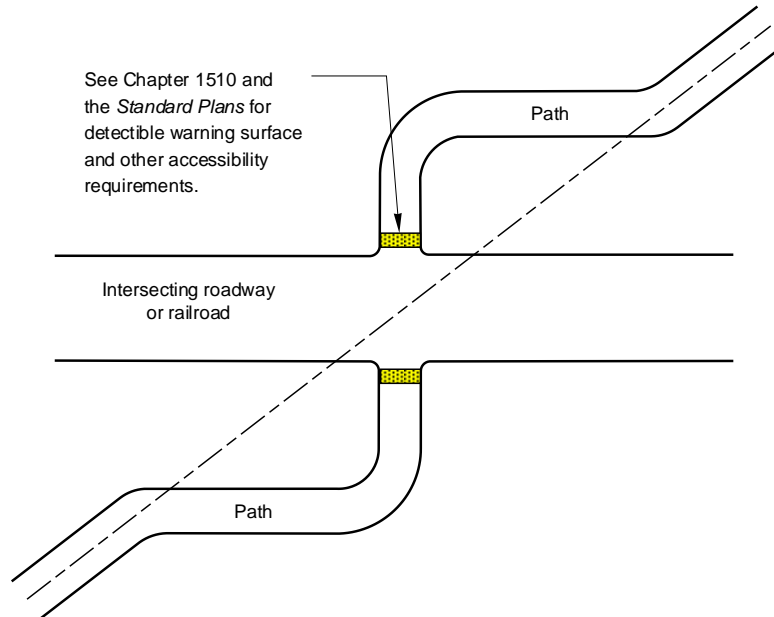

#### Notes:

For path and highway signing and markings, see the [MUTCD](#) and the [Standard Plans](#).

[http://www.wsdot.wa.gov/publications/fulltext/Standards/english/PDF/m09.60-00\\_e.pdf](http://www.wsdot.wa.gov/publications/fulltext/Standards/english/PDF/m09.60-00_e.pdf)

For radii approaching roadway intersections, see Exhibit 1515-2.

**Adjacent path crossings** are located at or near public intersection crosswalks and are normally placed with them. These crossings are usually placed with pedestrian crossings, where motorists can be expected to stop. If alternate intersection locations for a shared-use path are available, select the one with the greatest sight distance.

Adjacent path crossings occur where a path crosses an existing intersection of two roadways, a T intersection (including driveways), or a four-way intersection, as shown in Exhibit 1515-9. It is desirable to integrate this type of crossing close to an intersection so that motorists and path users recognize one another as intersecting traffic. The path user faces potential conflicts with motor vehicles turning left (A) and right (B) from the parallel roadway and on the crossed roadway (C, D, and E).

Consider crossing improvements on a case-by-case basis. Suggested improvements include: move the crossing; evaluate existing or proposed intersection control type; change signalization timing; or provide a refuge island and make a two-step crossing for path users.

Important elements that greatly affect the design of these crossings are traffic right of way assignments, traffic control devices, and the separation distance between path and roadway.

## Exhibit 1515 - 9 Adjacent Shared-Use Path Intersection

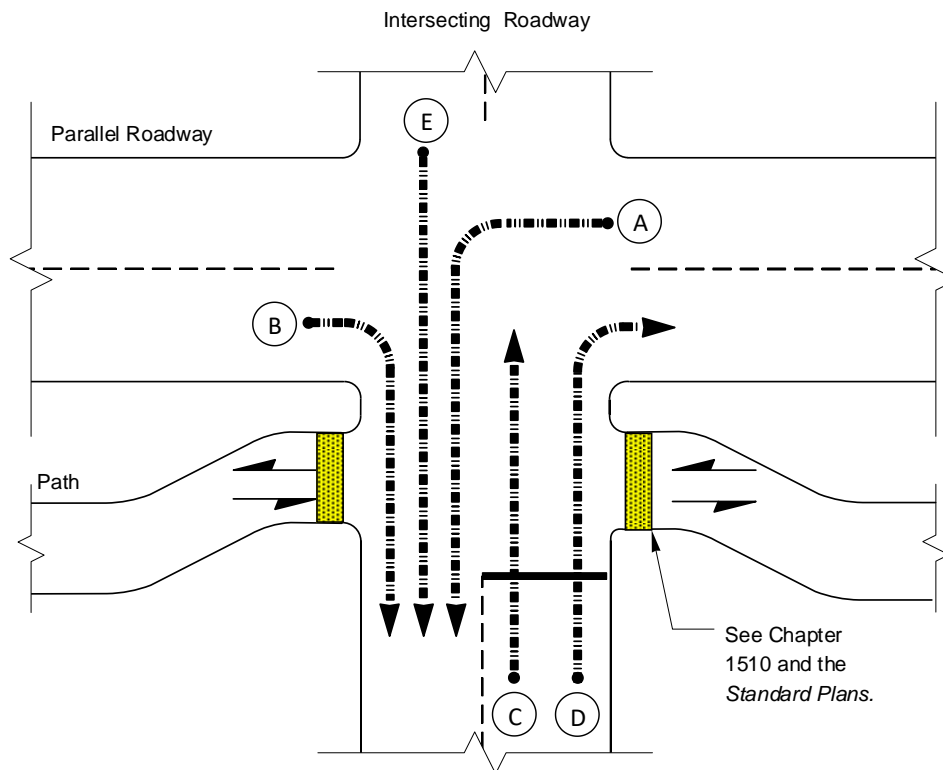

Note:

For signing and pavement markings, see the [MUTCD](#) and the [Standard Plans](#).

### Additional Roadway/Path Intersection Design Considerations

Additional roadway/path intersection design considerations include the following:

#### Evaluate Intersection Control

Determine the need for traffic control devices at path/roadway intersections by using [MUTCD](#) warrants and engineering judgment. Bicycles are considered vehicles in Washington State, and bicycle path traffic can be classified as vehicular traffic for [MUTCD](#) warrants. Provide traffic signal timing set for pedestrians.

#### Signal Actuation Mechanisms

Place the manually operated accessible pedestrian pushbutton in a location that complies with ADA requirements. For additional information, see Chapters 1330 and 1510. A detector loop in the path pavement may be provided in addition to the manually operated accessible pedestrian push button.

#### Signing

Provide sign type, size, and location in accordance with the [MUTCD](#). Place path STOP signs as close to the intended stopping point as feasible. Do not place the shared-use path signs where

they may confuse motorists or place roadway signs where they may confuse shared-use path users. For additional information on signing, see the MUTCD and Chapter 1020.

### Approach Treatments

Design shared-use path and roadway intersections with level grades, and provide sight distances. Provide advance warning signs and pavement markings that alert and direct path users that there is a crossing (see the [MUTCD](#)). Do not use speed bumps or other similar surface obstructions intended to cause bicyclists to slow down. Consider some slowing features such as horizontal curves (see Exhibits 1515-2 and 1515-8). Avoid locating a crossing where there is a steep downgrade where bike speeds could be high.

### Sight Distance

Sight distance is a principal element of roadway and path intersection design. At a minimum, provide stopping sight distance for both the roadway and the path at the crossing. Decision sight distance is desirable for the roadway traffic. Refer to Chapter 1260 for stopping sight distance for the roadway and 1515.04(5) for shared-use path stopping sight distance.

### Curb Ramp Widths

Design curb ramps with a width equal to the shared-use path. Curb ramps and barrier-free passageways are to provide a smooth transition between the shared-use path and the roadway or sidewalk (for pedestrians). Curb ramps at path/ roadway intersections must meet the requirements for curb ramps at a crosswalk. For design requirements, see Chapter 1510, and for curb ramp treatments at roundabouts, see Chapter 1320.

### Refuge Islands

Consider refuge islands where a shared-use path crosses a roadway when one or more of the following applies:

- High motor vehicle traffic volumes and speeds
- Wide roadways
- Use by the elderly, children, the disabled, or other slow-moving users

The refuge area may either be designed with the storage aligned perpendicularly across the island or be aligned diagonal (as shown in Exhibit 1515-10). The diagonal storage area has the added benefit of directing attention toward oncoming traffic since it is angled toward the direction from which traffic is approaching.

### **1515.03(2) At-Grade Railroad Crossings**

Wherever possible, design the crossing at right angles to the rails. For signing and pavement marking for a shared-use path crossing a railroad track, see the [MUTCD](#) and the [Standard Plans](#). Also, see Chapter 1510 for design of at-grade pedestrian railroad crossings.

Exhibit 1515 - 10 Roadway Crossing Refuge Area

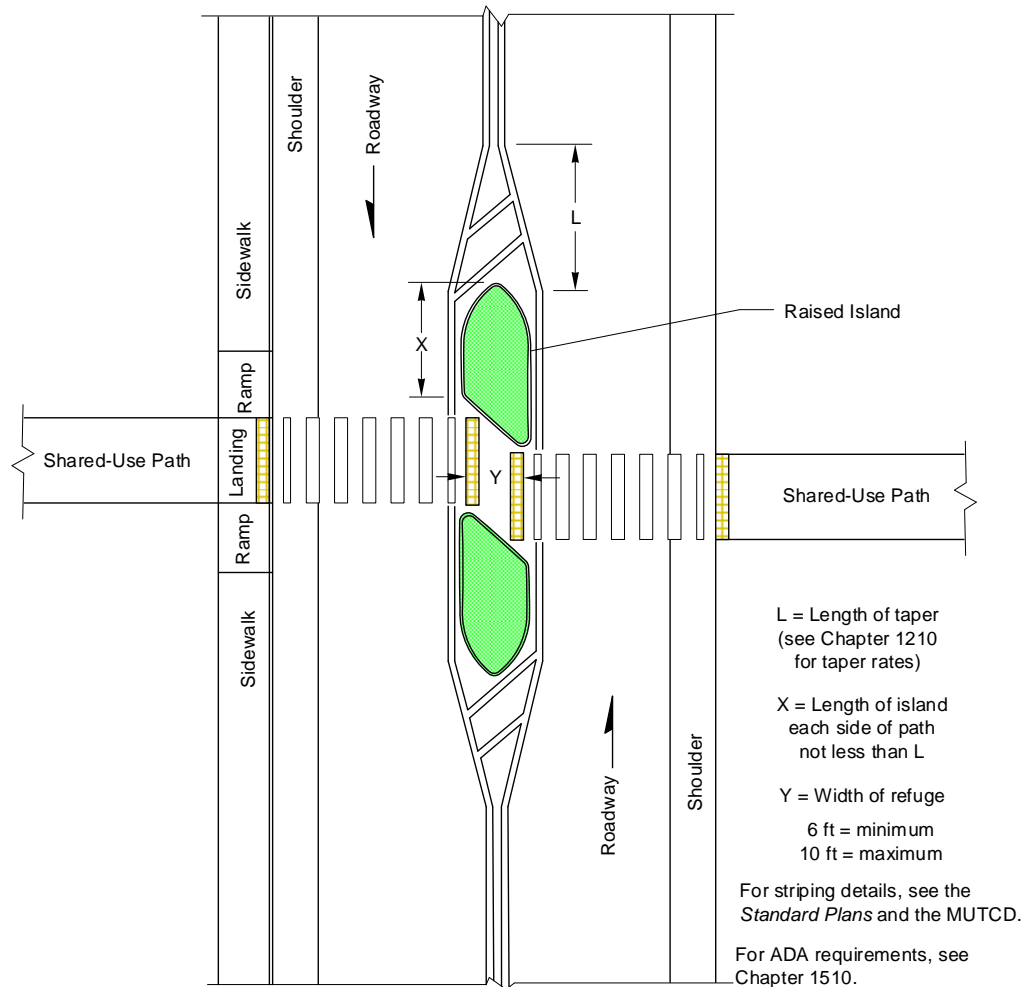

Note:

This exhibit shows a case where a path intersects a roadway framed with both a sidewalk and a paved shoulder, for the purpose of showing detectible warning surface placements.

**1515.04 Grade Separation Structures**

Provide the same minimum clear width as the approach paved shared-use path plus the graded clear areas.

Carrying full widths across structures has two advantages:

- The clear width provides a minimum horizontal shy distance from the railing or barrier.
- It provides needed maneuvering room to avoid pedestrians and other bicyclists.

For undercrossings and tunnels, it is the Designer's responsibility to determine the correct minimum vertical clearance (shared use path pavement surface to overhead obstruction) of



each undercrossing or tunnel based on coordination with maintenance and emergency services. The minimum vertical clearance for bicyclists and equestrians is 10 feet.

Consult the region Maintenance Office and the HQ Bridge Preservation Office to verify that the planned path width and vertical clearance meets their needs. If not, widen and/or increase vertical clearance to their specifications.

Use expansion joints that accommodate shared-use path users. Expansion joints should be perpendicular to the path and have a maximum gap of ½ inch or be covered with a slip-resistant plate.

The installation of protective screening is analyzed on a case-by-case basis. Refer to Chapter 720 for guidance.

### Exhibit 1515 - 11 Shared-Use Path Bridge and Approach Walls



**Note:**

On structures, the bridge railing type and height are part of the structure design. Contact the HQ Bridge and Structures Office for additional information.

**Exhibit 1515 - 12 Bridge and Pedestrian Rail****Notes:**

The photo above shows a bridge with a shared-use path separating the users from the roadway. Pedestrian rail is used on the outside edge.

On structures, the bridge railing type and height are part of the structure design. Contact the HQ Bridge and Structures Office for additional information.

**1515.05 Signing, Pavement Markings, and Illumination**

Generally, WSDOT does not provide continuous centerline striping or channelization for user modes on shared-use paths. However, signing and pavement markings can be beneficial to warn shared-use path users of curves, grades, obstructions, and intersections.

Refer to the [MUTCD](#) for guidance and directions regarding signing (regulatory, warning, and way finding) and pavement markings.

The [Standard Plans](#) shows shared-use path pavement markings at obstructions in accordance with the MUTCD and also shows placement of detectible warning surfaces.

For pavement marking around bollards and other obstructions, see Standard Plan M-9.60:

[http://www.wsdot.wa.gov/publications/fulltext/standards/english/pdf/m09.60-00\\_e.pdf](http://www.wsdot.wa.gov/publications/fulltext/standards/english/pdf/m09.60-00_e.pdf)

The level of illumination on a shared-use path is dependent on the amount of nighttime use expected and the nature of the area surrounding the facility. If illumination is used, provide illumination in accordance with Chapter 1040.

**1515.06 Restricted Use Controls**

This section presents considerations on use of fencing and other treatments to restrict roadway and path users to their domains.

### 1515.06(1) Fencing

Limited access highways often require fencing or other forms of controlling access. Shared-use paths constructed within these corridors, such as shown in Exhibit 1515-13, likely require fencing. For guidance on fencing, limited access controls, and right of way, refer to Division 5 of the *Design Manual*. Evaluate the impacts of fencing on sight distances.

#### Exhibit 1515 - 13 Shared-Use Path in Limited Access Corridor



### 1515.06(2) Restriction of Motor Vehicle Traffic

Shared-use paths often need some form of physical barrier at roadway intersections to prevent unauthorized motor vehicles from entering.

Bollards have been used by many path owners to prevent unauthorized vehicle access. However, bollards should not be applied indiscriminately, and there are other considerations to bollard installation.

#### 1515.06(2)(a) Landscaped Islands

A preferred method of restricting entry of motor vehicles is to split the entry way into two sections separated by low landscaping, thereby splitting a path into two channels at roadway intersections. This method essentially creates an island in the middle of the path rather than installing a bollard. Such an island could be planted with low-growing, hardy vegetation capable of withstanding the occasional authorized vehicle traveling over it. When splitting a path, employ MUTCD pavement markings and signing, such as is used for bollards and obstructions.

### 1515.06(2)(b) Bollard Considerations

Typically, one bollard located in the center of the path is sufficient to control motor vehicle access to the path. If more than one bollard is needed, the additional bollards should be placed at the edge of the shared-use path.

Install bollards at entrances to shared-use paths to discourage motor vehicles from entering. Do not use bollards to divert or slow path traffic. When locating such installations, stripe an envelope around the bollards and paint and reflectorize them to be visible to path users both day and night. Bollards located on or adjacent to shared-use paths represent an object that needs to be avoided by bicyclists and pedestrians. To increase the potential for appropriate maneuvering to occur, provide designs where the post is clearly visible and recognizable.

When designing bollards, the following apply:

- The desirable design is to provide a single bollard, installed in the middle of the path to reduce confusion.
- When multiple bollard posts are used in wide path sections, use a minimum 5-foot spacing between the edge of concrete footings to permit passage of bicycle-towed trailers, wheelchairs, and adult tricycles, with room for bicycle passage without dismounting.
- Provide 4 feet minimum (5 feet desirable) clear width between the edge of concrete footing and edge of path.
- At a minimum, provide stopping sight distance to bollards. An ideal location for bollard placement is in a relatively straight area of the path where the post placement has the stopping sight distance given in Exhibit 1515-14a and 14b. Do not place bollards in difficult-to-see locations (for example, immediately upon entering a tunnel).
- For cases where multiple posts are used longitudinally along the path, locate them at least 20 feet apart, with the first post in line from each direction having stopping sight distance.
- Use a contrasting striping pattern on the post.
- Use reflective materials on the post, such as a band at the top and at the base.
- Design all bollards along a corridor to be uniform in appearance. Frequent cyclists can become familiar with the posts and recognize them easily.
- Provide pavement markings in accordance with the [Standard Plans](#) and [MUTCD](#) at all bollards on paved paths.
- Use removable bollards (Bollard Type 1) to permit access by emergency and service vehicles.
- Non-removable bollards (Bollard Type 2) may be used where access is not needed.

Refer to the [Standard Plans](#) for bollard designs and the [Standard Plans](#) and [MUTCD](#) for pavement markings at bollards.

When bollards need to be placed near the roadway, see Chapter 1600 for clear zone requirements.

## 1515.07 Documentation

For the list of documents required to be preserved in the Design Documentation Package and the Project File, see the Design Documentation Checklist:

[www.wsdot.wa.gov/design/projectdev/](http://www.wsdot.wa.gov/design/projectdev/)

### Exhibit 1515 - 14a Stopping Sight Distance for Downgrades

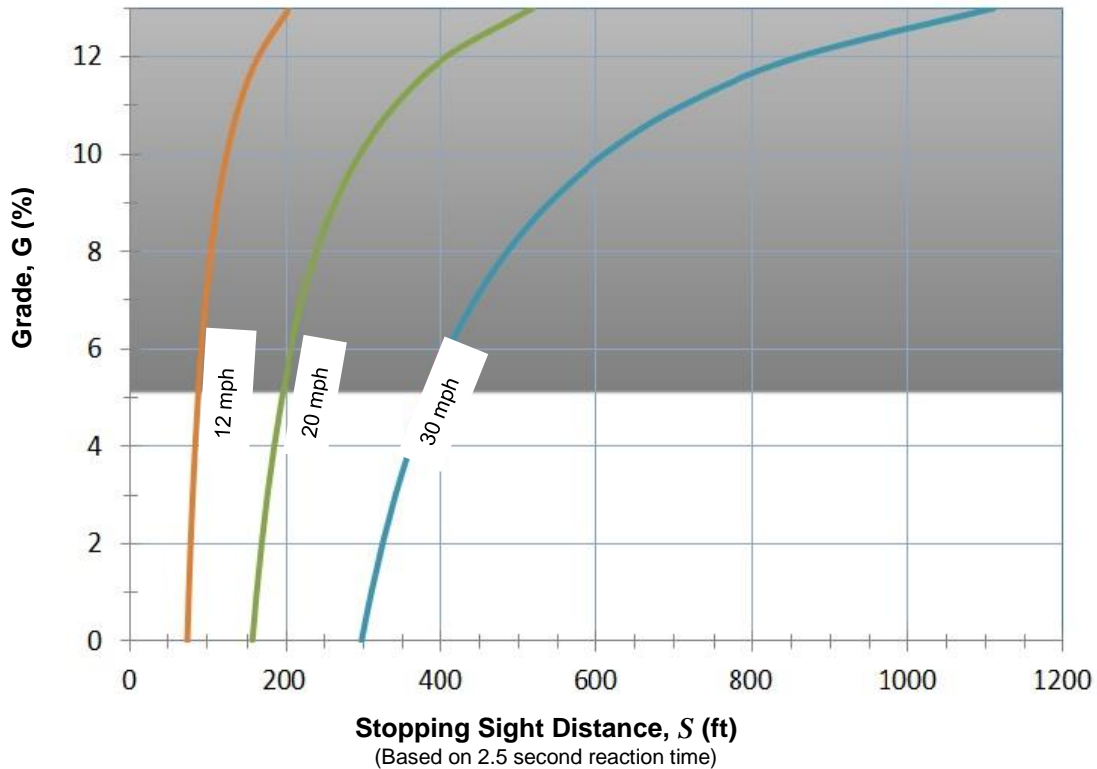

Note:

Shaded area represents grades greater than 5%.

$$S = \frac{V^2}{0.30(f - G)} + 3.67V$$

Where:

- $S$  = Stopping sight distance (ft)
- $V$  = Speed (mph)
- $f$  = Coefficient of friction (use 16)
- $G$  = Grade (%)

Exhibit 1515 – 14b Stopping Sight Distance for Upgrades

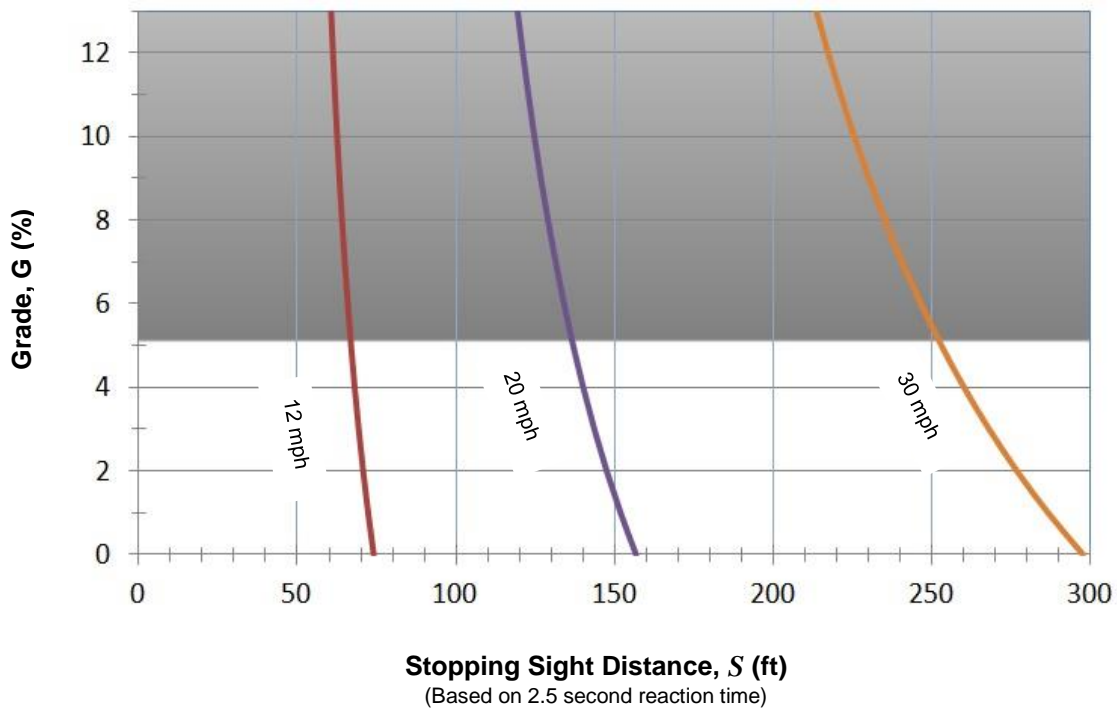

Note:

Shaded area represents grades greater than 5%.

$$S = \frac{V^2}{0.30(f + G)} + 3.67V$$

Where:

- $S$  = Stopping sight distance (ft)
- $V$  = Speed (mph)
- $f$  = Coefficient of friction (use 16)
- $G$  = Grade (%)



Exhibit 1515 - 15 Minimum Lengths for Crest Vertical Curves

A (%)	Stopping Sight Distance, S (ft)													
	40	60	80	100	120	140	160	180	200	220	240	260	280	
2	3	3	3	3	3	3	3	3	3	3	30	70	110	150
3	3	3	3	3	3	3	20	60	100	140	180	220	260	300
4	3	3	3	3	15	55	95	135	175	215	256	300	348	400
5	3	3	3	20	60	100	140	180	222	269	320	376	436	500
6	3	3	10	50	90	130	171	216	267	323	384	451	523	600
7	3	3	31	71	111	152	199	252	311	376	448	526	610	700
8	3	8	48	88	128	174	228	288	356	430	512	601	697	800
9	3	20	60	100	144	196	256	324	400	484	576	676	784	900
10	3	30	70	111	160	218	284	360	444	538	640	751	871	1,000
11	3	38	78	122	176	240	313	396	489	592	704	826	958	1,100
12	5	45	85	133	192	261	341	432	533	645	768	901	1,045	1,200
13	11	51	92	144	208	283	370	468	578	699	832	976	1,132	1,300
14	16	56	100	156	224	305	398	504	622	753	896	1,052	1,220	1,400
15	20	60	107	167	240	327	427	540	667	807	960	1,127	1,307	1,500
16	24	64	114	178	256	348	455	576	711	860	1,024	1,202	1,394	1,600
17	27	68	121	189	272	370	484	612	756	914	1,088	1,277	1,481	1,700
18	30	72	128	200	288	392	512	648	800	968	1,152	1,352	1,568	1,800
19	33	76	135	211	304	414	540	684	844	1,022	1,216	1,427	1,655	1,900
20	35	80	142	222	320	436	569	720	889	1,076	1,280	1,502	1,742	2,000
21	37	84	149	233	336	457	597	756	933	1,129	1,344	1,577	1,829	2,100
22	39	88	156	244	352	479	626	792	978	1,183	1,408	1,652	1,916	2,200
23	41	92	164	256	368	501	654	828	1,022	1,237	1,472	1,728	2,004	2,300
24	43	96	171	267	384	523	683	864	1,067	1,291	1,536	1,803	2,091	2,400
25	44	100	178	278	400	544	711	900	1,111	1,344	1,600	1,878	2,178	2,500

Minimum Length of Vertical Curve, L (ft)

$$L = \frac{AS^2}{900} \quad \text{when } S < L$$

$$L = 2S - \frac{900}{A} \quad \text{when } S > L$$

Where:

S = Stopping sight distance (ft)

A = Algebraic difference in grade (%)

L = Minimum vertical curve length (ft)

Based on an eye height of 4.5 ft and an object height of 0 ft.

Note:

Below represents S ≤ L.

represents A > 10%.

**Exhibit 1515 - 16 Lateral Clearance for Horizontal Curves**

Height of eye: 4.50 ft

Height of object: 0.0 ft

Line of sight at the *M* distance is normally 2.3 ft above centerline of inside lane at point of obstruction, provided no vertical curve is present in horizontal curve.

$$M = R \left( 1 - \cos \frac{S 28.65}{R} \right)$$

$$S = \frac{R}{28.65} \left[ \cos^{-1} \left( \frac{R - M}{R} \right) \right]$$

*S* ≤ Length of curve

Angle is expressed in degrees.

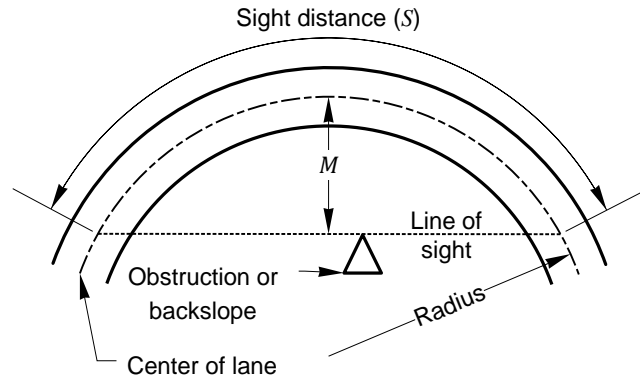

Where:

*S* = Sight distance (ft)

*R* = Centerline radius of inside lane (ft)

*M* = Distance from inside lane centerline (ft)

<i>R</i> (ft)	Stopping Sight Distance, <i>S</i> (ft) <sup>[1]</sup>													
	40	60	80	100	120	140	160	180	200	220	240	260	280	300
25	7.6	15.9												
50	3.9	8.7	15.2	23.0	31.9	41.5								
75	2.7	5.9	10.4	16.1	22.7	30.4	38.8	47.8	57.4	67.2				
95	2.1	4.7	8.3	12.9	18.3	24.6	31.7	39.5	47.9	56.9	66.2	75.9	85.8	
125	1.6	3.6	6.3	9.9	14.1	19.1	24.7	31.0	37.9	45.4	53.3	61.7	70.5	79.7
150	1.3	3.0	5.3	8.3	11.8	16.0	20.8	26.2	32.1	38.6	45.5	52.9	60.7	69.0
175	1.1	2.6	4.6	7.1	10.2	13.8	18.0	22.6	27.8	33.4	39.6	46.1	53.1	60.4
200	1.0	2.2	4.0	6.2	8.9	12.1	15.8	19.9	24.5	29.5	34.9	40.8	47.0	53.7
225	0.9	2.0	3.5	5.5	8.0	10.8	14.1	17.8	21.9	26.4	31.2	36.5	42.2	48.2
250	0.8	1.8	3.2	5.0	7.2	9.7	12.7	16.0	19.7	23.8	28.3	33.0	38.2	43.7
275	0.7	1.6	2.9	4.5	6.5	8.9	11.6	14.6	18.0	21.7	25.8	30.2	34.9	39.9
300	0.7	1.5	2.7	4.2	6.0	8.1	10.6	13.4	16.5	19.9	23.7	27.7	32.1	36.7
350	0.6	1.3	2.3	3.6	5.1	7.0	9.1	11.5	14.2	17.1	20.4	23.9	27.6	31.7
400	0.5	1.1	2.0	3.1	4.5	6.1	8.0	10.1	12.4	15.0	17.9	20.9	24.3	27.8
500	0.4	0.9	1.6	2.5	3.6	4.9	6.4	8.1	10.0	12.1	14.3	16.8	19.5	22.3
600	0.3	0.7	1.3	2.1	3.0	4.1	5.3	6.7	8.3	10.1	12.0	14.0	16.3	18.7
700	0.3	0.6	1.1	1.8	2.6	3.5	4.6	5.8	7.1	8.6	10.3	12.0	14.0	16.0
800	0.2	0.6	1.0	1.6	2.2	3.1	4.0	5.1	6.2	7.6	9.0	10.5	12.2	14.0
900	0.2	0.5	0.9	1.4	2.0	2.7	3.6	4.5	5.5	6.7	8.0	9.4	10.9	12.5
1,000	0.2	0.4	0.8	1.2	1.8	2.4	3.2	4.0	5.0	6.0	7.2	8.4	9.8	11.2

**Minimum Lateral Clearance, *M* (ft)**

Note:

[1] *S* is the sum of the distances (from Exhibits 1515-14a and 14b) for bicyclists traveling in both directions.