



BERNINA 770 QE PLUS

User Manual

Table of Contents

IMPORTANT SAFETY INSTRUCTIONS	9	Swiveling spool pin	36
Important information	12	Horizontal spool pin	36
1 My BERNINA	14	2.6 Free arm	37
1.1 Introduction	14	2.7 Feed dog	37
1.2 BERNINA Quality control	14	Adjusting the feed dog	37
1.3 Welcome to the world of BERNINA	14	2.8 Slide-on table	38
1.4 Overview Machine	16	Using the slide-on table	38
Overview front controls	16	2.9 Presser foot	38
Overview front	17	Adjusting the presser foot position via the knee lifter of the Free Hand System	38
Overview sideways	18	Adjusting the presser foot position via the button «Presser foot up/down»	38
Overview - Back panel	19	Changing the presser foot	38
1.5 Supplied accessories	20	Selecting the presser foot in the User Interface	39
Overview accessories machine	20	Adjusting the presser foot pressure	40
Overview presser feet	22	2.10 Needle and stitch plate	40
Accessory box	24	Changing the needle	40
1.6 Overview User Interface	25	Selecting the needle in the User Interface	41
Overview functions/visual information	25	Selecting needle type and needle size	41
Overview System settings	25	Adjusting the needle position up/down	41
Overview selection menu sewing	26	Adjusting the needle position left/right	42
Software operation	26	Needle stop up/down (permanent)	42
1.7 Needle, Thread, Fabric	28	Changing the stitch plate	42
Overview Needles	28	Selecting the stitch plate in the User Interface	43
Example for needle description	30	2.11 Threading	43
Thread selection	30	Threading the upper thread	43
Needle/thread combination	31	Threading the double needle	46
2 Sewing preparation	32	Threading the triple needle	46
2.1 Before using the machine for the first time	32	Winding the bobbin thread	47
2.2 Accessory box	32	Threading the bobbin thread	48
Accessory box free standing	32	Indicating fill level of bobbin thread	50
Storing accessory	32	3 Setup Program	51
2.3 Connection and Switching on	33	3.1 Sewing settings	51
Connecting the foot control	33	Adjusting the upper thread tension	51
Connecting the machine	33	Adjusting the maximum sewing speed	51
Attaching the knee lifter of the Free Hand System	34	Programming the securing stitches	51
Fixing the touchscreen pen	34	Adjusting the hovering height of the presser foot	51
Switching the machine on	35	Programming the button «Pattern end»	52
2.4 Foot control	35	Programming the button «Thread cutter»	53
Regulating the speed via the foot control	35	Adjusting the presser foot position with needle stop down	53
Activate/deactivate additional function	35	Programming the button «Quick reverse»	54
2.5 Spool pin	36	Programming the button «Securing»	54
		Programming the foot control	54

3.2	Embroidery settings	55	Changing the stitch length	71
	Adjusting the upper thread tension	55	Correcting the balance	72
	Adjusting the maximum embroidering speed	56	Programming pattern repeat	72
	Centering or opening embroidery motifs in the original position	56	Programming long stitch	72
	Calibrating the embroidery hoop	56	Mirror image of stitch patterns	73
	Entering the fabric thickness	57	Editing stitch pattern length	73
	Activating/Deactivating the function thread away	57	Programming the stitch counter function	73
	Programming the securing stitches	58	Sewing stitch patterns using the triple stitch	73
	Adjusting the thread cut	58	Quick reverse	74
	Changing the measuring unit	59	Permanent Quick reverse	74
3.3	Selecting personal settings	59	Backstepping	74
3.4	Monitoring functions	60	5.6 Combining stitch patterns	74
	Activating the upper thread indicator	60	Overview Combi mode	74
	Activating the bobbin thread indicator	60	Creating Stitch pattern combinations	75
3.5	Activating the audio signals	60	Saving a stitch pattern combination	75
3.6	Machine settings	61	Loading a stitch pattern combination	75
	Selecting a language	61	Overwriting a stitch pattern combination	75
	Adjusting the brightness of the display	61	Deleting a stitch pattern combination	76
	Adjusting the sewing light	61	Editing a single stitch pattern	76
	Calibrating the display	62	Deleting a single stitch pattern	76
	Back to default setting	62	Adding a single stitch pattern	77
	Deleting user data	62	Adapting the stitch pattern length and stitch pattern width	77
	Deleting motifs on the BERNINA USB Stick	63	Mirroring a stitch pattern combination	78
	Calibrating the Buttonhole foot No. 3A	63	Stitch pattern combination Subdivider 1	78
	Packing the embroidery module	64	Stitch pattern combination Subdivider 2	79
	Reviewing the total number of stitches	64	Securing a stitch pattern combination	79
	Registering details of the dealer	64	Programming pattern repeat	79
	Saving Service data	65	5.7 Administering stitch patterns	80
	Display machine ID	65	Saving settings of stitch patterns	80
4	System settings	67	Calling up the previously sewn stitch patterns	80
4.1	Calling up the Tutorial	67	Saving stitch patterns in personal memory	80
4.2	Calling up the Creative Consultant	67	Overwriting stitch patterns from the personal memory	80
4.3	Calling up the Help	67	Loading stitch patterns from the personal memory	81
4.4	Using eco mode	67	Deleting stitch patterns from the personal memory	81
4.5	Cancelling any alterations with «clr»	67	Saving stitch patterns on the BERNINA USB stick	81
5	Creative sewing	68	Uploading a stitch pattern from the BERNINA USB stick	81
5.1	Overview selection menu sewing	68	Deleting stitch patterns from the BERNINA USB stick	82
	Selecting a stitch pattern	68	5.8 Securing	82
5.2	BERNINA Dual Feed	68	Securing with the button «Pattern end»	82
	Application of the BERNINA Dual Feed	69	Securing via the icon «Securing»	82
5.3	Regulating the speed	70	5.9 Height Compensation of uneven layers	83
5.4	Adjusting the upper thread tension	70	5.10 Sewing Corners	84
5.5	Editing stitch patterns	71	6 Practical stitches	85
	Changing the stitch width	71	6.1 Overview Practical Stitches	85
			6.2 Sewing straight stitch	88
			6.3 Securing with the automatic Securing Program	88

6.4	Sewing in the zipper	89		Using cord with the Buttonhole Foot #3	115
6.5	Sewing both sides of the zipper from bottom to top	90	9.6	Sewing a test sample	116
6.6	Sewing Triple straight stitch	91	9.7	Determining the buttonhole slit width	116
6.7	Sewing Triple Zigzag	91	9.8	Determining the buttonhole length with the Buttonhole Foot with Slide #3A	117
6.8	Manual darning	92	9.9	Determining the buttonhole length with Buttonhole Foot #3C	117
6.9	Automatic darning	94	9.10	Sewing a buttonhole automatically	118
6.10	Reinforced darning, automatic	94	9.11	Programming the Heirloom buttonhole	119
6.11	Finishing edges	95	9.12	Sewing the manual 7-step buttonhole with the Buttonhole Foot #3C	119
6.12	Sewing Double overlock	96	9.13	Sewing the manual 5-step buttonhole with the Buttonhole Foot #3C	120
6.13	Narrow edgestitching	96	9.14	Cutting the buttonhole open with the seam ripper ..	121
6.14	Wide edgestitching	96	9.15	Cutting open buttonholes with the buttonhole cutter (optional accessory)	121
6.15	Edgestitching using the seam guide	97	9.16	Sewing on buttons	121
6.16	Sewing hem edges	97	9.17	Sewing eyelets	122
6.17	Sewing blind hems	98	10	Quilting	123
6.18	Sewing visible hems	99	10.1	Overview Quilt Stitches	123
6.19	Sewing flat joining seams	100	10.2	Quilting, Securing Program	124
6.20	Sewing basting stitches	100	10.3	Sewing handlook quilt stitches	124
7	Decorative stitches	101	10.4	Guiding the quilt work freely	125
7.1	Overview Decorative Stitches	101	11	BERNINA Stitch Regulator (BSR)	126
7.2	Bobbin-Play	102	11.1	BSR mode 1	126
7.3	Altering the stitch density	103	11.2	BSR mode 2	126
7.4	Sewing cross stitches	103	11.3	BSR mode 3	126
7.5	Pintucks	104	11.4	BSR function with Straight stitch No. 1	126
	Pintucks	104	11.5	BSR function with Zigzag No. 2	126
	Overview Pintuck Feet	104	11.6	Sewing preparations for quilting	126
	Working with cord	105		Attach the BSR presser foot	126
	Sewing Pintucks	106		Changing the presser foot sole	127
8	Alphabets	107	11.7	Using the BSR mode	128
8.1	Overview Alphabet	107	11.8	Securing	128
8.2	Creating lettering	108		Securing in BSR1 Mode with the button «Start/Stop» ...	128
8.3	Altering font size	109		Securing in BSR2 Mode	129
9	Buttonholes	110	11.9	Using the KickStart function	129
9.1	Overview Buttonholes	110	12	My BERNINA Embroidery	130
9.2	Making use of the height compensation tool	112	12.1	Overview Embroidery module	130
9.3	Using the compensation plate	112	12.2	Supplied accessories Embroidery module	130
9.4	Marking buttonholes	113			
9.5	Cord	114			
	Using cord with the Buttonhole Foot with Slide #3A ...	114			



Overview accessory Embroidery module	130	Grid on/off	147
12.3 Overview User Interface	132	Locating the center of the embroidery motif	147
Overview functions/visual information	132	Virtual positioning of the embroidery hoop	147
Overview System settings	132	14 Setup Program	148
Overview Selection menu embroidery	133	14.1 Adjusting the embroidery settings in the Setup Program	148
12.4 Important Embroidery information	133	15 Creative embroidering	149
Upper thread	133	15.1 Overview embroidering	149
Bobbin thread	134	15.2 Selecting and changing the embroidery motif	149
Choosing the embroidery motif	134	15.3 Checking the embroidery time and the embroidery motif size	149
Selecting the embroidery file format	134	15.4 Regulating the speed	149
Embroidery test	134	15.5 Editing the embroidery motif	150
The size of the embroidery motif	134	Overview Editing embroidery motif	150
Embroidering motifs by third-party providers	134	Scaling up the embroidery motif view	150
Underlay stitches	135	Downsizing the embroidery motif view	150
Satin or Leaf stitch	135	Moving the embroidery motif view	151
Step stitch	135	Moving the embroidery motif in enlarged view	151
Connecting stitches	136	Moving the embroidery motif	151
13 Embroidering preparation	137	Rotating motif	152
13.1 Attaching the Module	137	Altering the embroidery motif size proportionally	152
13.2 Preparing the machine	138	Altering the embroidery motif size disproportionately	153
Lowering the feed dog	138	Mirroring embroidery motifs	153
Selecting an embroidery motif	138	Bending the text	153
13.3 Embroidery foot	138	Changing the stitch type	154
Attaching the embroidery foot	138	Altering the stitch density	154
Selecting the presser foot in the User Interface	139	Checking the size and the position of the embroidery motif	155
13.4 Needle and stitch plate	139	Deleting an embroidery motif	155
Inserting the embroidery needle	139	Changing the sequence within an embroidery motif combination	155
Selecting the embroidery needle in the User Interface	140	Grouping embroidery motifs	156
Selecting needle type and needle size	140	15.6 Pinpoint placement	157
Attaching the stitch plate	141	Positioning of grid points	157
Selecting the stitch plate in the User Interface	142	Free point positioning	158
Thread-up command	142	15.7 Combining embroidery motifs	159
13.5 Embroidery hoop	142	Combining embroidery motifs	159
Overview Embroidery hoop selection	142	Deleting a single embroidery motif	159
Selecting the embroidery hoop	142	Duplicating the embroidery motif	160
Tear-away stabilizers	143	Duplicating a combination	160
Cut-away stabilizers	143	15.8 Creating lettering	161
Using adhesive spray	143	Overview embroidery alphabets	161
Using spray starch	143	Creating words/sentences	161
Using iron-on interfacing	143	Editing words/sentences	162
Using paper-backed adhesive stabilizer	144	15.9 Changing the colors of the embroidery motif	163
Using water-soluble stabilizer	144	Overview changing the color	163
Preparing the embroidery hoop	144	Changing the colors	163
Attaching the hoop	145		
Overview Embroidery functions	146		
Center the needle to the embroidery hoop	146		
Moving the hoop to the back	146		
Moving the module for the sewing mode	146		

Changing the thread brand	164	18.2 Troubleshooting	183
15.10 Embroidering the embroidery motif	164	19 Storage and disposal	187
Overview Embroidery menu	164	19.1 Storing the machine	187
Adding basting stitches	164	19.2 Dispose of the machine	187
Moving the hoop	165	20 Technical data	188
Embroidery sequence control when thread breaks	165	21 Overview stitch patterns	189
Cutting connecting stitches	165	21.1 Overview Stitch patterns	189
Reducing color changes	165	Practical stitches	189
Multi-colored embroidery motif on/off	166	Buttonholes	189
Color indication	166	Decorative stitches	189
15.11 Freearm Embroidery	166	Quilt stitches	192
15.12 Administering embroidery motifs	167	21.2 Overview Embroidery motifs	193
Administering embroidery motifs	167	Editing embroidery motifs	193
Saving embroidery motifs in the personal memory	167	Quilt motifs	193
Saving the embroidery motif on the BERNINA USB stick	167	Quilting in the hoop	199
Overwriting the embroidery motif in the personal memory	168	Projects	201
Overwriting the embroidery motif on the BERNINA USB stick	168	Children	203
Importing stitch patterns	168	Animals	205
Loading an embroidery motif from the personal memory	169	Borders	207
Loading an embroidery motif from the BERNINA USB stick	169	Sport and hobbies	209
Deleting an embroidery motif from the personal memory	169	Embellishment	210
Deleting an embroidery motif from the BERNINA USB stick	170	Borders and Lace	213
16 Embroidery	171	Seasons	215
16.1 Embroidering via the button «Start/Stop»	171	Flowers	218
16.2 Increasing the embroidery speed	171	DesignWorks	221
16.3 Adjusting the upper thread tension	171	Index	224
16.4 Embroidering via the foot control	172		
17 Care and maintenance	173		
17.1 Firmware	173		
Checking the firmware version	173		
Updating firmware	173		
Recovering saved data	174		
17.2 Machine	174		
Cleaning the display	174		
Cleaning the feed dog	174		
Cleaning the hook	175		
Lubricating the hook	176		
Cleaning the thread catcher	178		
18 Errors and faults	179		
18.1 Error messages	179		



IMPORTANT SAFETY INSTRUCTIONS

Please be aware of the following basic safety instructions when using your machine. Before using this machine, read instruction manual carefully.

DANGER

To protect against electric shock, the following instructions must be observed.

- Never leave the machine unattended when it is connected to the power supply.
- Immediately after use and before cleaning, switch off the machine and disconnect the power cable from the outlet.

In order to protect against injury, the following instructions must be adhered to.

- Do not look directly into the LED lamp with optical instruments (e. g. magnifying glass).
- If the LED lamp is damaged or defective, have the LED lamp checked or repaired at your local authorized BERNINA dealer.
- Switch off the machine before working in the needle area.
- Before starting the machine, close all covers.

WARNING

To reduce the risk of burns, fire, electric shock or injury to persons, the following instructions must be observed.

General facts

- This machine may only be used for the purpose described in this instruction manual.

Working environment

- Do not use the machine outdoors.
- Only use the machine in dry rooms.
- Do not use the machine in a humid area.
- Do not use the machine in rooms where aerosol products (sprays) are being used.
- Do not use the machine in rooms where oxygen is dispensed.

Technical condition

- Never use the machine when it is damp.
- Do not use the machine if it is not working properly.



- Do not use the machine if a cable or the plug is damaged.
- Do not use the machine if it has been dropped, damaged or has fallen into water.
- If the machine is damaged or does not work properly, have the machine checked or repaired by your local authorized BERNINA dealer.
- Keep all ventilation openings of the machine and the foot control free of lint, dust and loose cloth.
- Do not use the machine if the ventilation openings are blocked.

Accessories and Supplies

- Only use the accessories recommended by the manufacturer.
- Always use the original BERNINA Stitch Plate.
An incorrect stitch plate can result in needle breakage.
- Use only straight needles of good quality.
Bent or damaged needles can cause needle breakage.
- This machine is double-insulated (except for USA, Canada and Japan).
Use only identical replacement parts. See instructions for servicing of double-insulated products.
- To lubricate the machine, only use oil recommended by BERNINA.

Safety instructions

- While operating the machine, all protective inserts must be in place and all covers must be closed.

Appropriate use

- The machine may be used, cleaned and maintained by children older than eight or by people with reduced physical, sensory or mental capabilities or if there is a lack of experience and knowledge as long as they have been given instructions.
- Furthermore, these persons must be supervised while working with the machine, and/or they must know the safe operation of the machine and be aware of the resulting hazards.
- Children must not play with the machine.
- Special care should be taken when the machine is operated by or in the presence of children.
- Only use the machine with the supplied power cable.
- The power cable for USA and Canada (power plug NEMA 1-15) may only be used for a maximum supply voltage of 150 volt-to-ground.
- Only use this machine with the supplied foot control of type LV-1.
- Do not insert any objects into the openings of the machine.



Important information

Availability of the instruction manual

The instruction manual is supplied with the machine.

- Keep the instruction manual safe at a suitable place near the machine to have it at hand in case that you need to look up something.
- If you pass the machine to a third party, always include the instruction manual.
- The latest version of the instruction manual can be downloaded at www.bernina.com

Proper use

Your BERNINA machine is conceived and designed for private household use. It is intended for sewing fabrics and other materials as described in this instruction manual. Any other use is not considered proper. BERNINA assumes no liability for consequences resulting from improper use.


Equipment and scope of delivery

Example images are used in these operating instructions for the purposes of illustration. The machines shown in the images and the accessories shown therefore do not always match the actual items included with your machine. The supplied accessory can vary depending on the country of delivery. You can acquire any accessories mentioned or shown that are not included in the scope of delivery as optional accessories from a specialist BERNINA dealer. Further accessories can be found at www.bernina.com.

For technical reasons and in order to improve the product, changes may be made to the equipment of the machine and the scope of delivery at any time and without prior notice.

Maintenance of double-insulated products

In a double-insulated product, two systems of insulation are provided instead of grounding. No grounding means is provided on a double-insulated product nor should a means for grounding be added to the product. Servicing a double-insulated product requires extreme care and knowledge of the system and should only be done by qualified service personnel. Only original spare parts should be used for service and repairs. A double-insulated product is marked with the words: «Double-Insulation »or «double-insulated».

 The symbol may also be marked on the product.

Environmental Protection

BERNINA is committed to the protection of the environment. We strive to minimize the environmental impact of our products by continuously improving product design and our technology of manufacturing.



The machine is labeled with the symbol of the crossed-out wastebin. This means that the machine should not be disposed of in household waste when it is no longer needed. Improper disposal can result in dangerous substances getting into the groundwater and thus into our food chain, damaging our health.

The machine must be returned free of charge to a nearby collection point for waste electrical and electronic equipment or to a collection point for the reuse of the machine. Information on the collection points can be obtained from your local administration. When purchasing a new machine, the dealer is obliged to take back the old machine free of charge and dispose of it properly.

If the machine contains personal data, you are responsible for deleting the data yourself before returning the machine.

1 My BERNINA

1.1 Introduction

With your BERNINA 770 QE PLUS you can sew, embroider and quilt. Delicate silk or satin fabrics as well as heavyweight linen, fleece and denim can be sewn successfully with this machine. Numerous practical as well as decorative stitches, buttonholes and embroidery motifs are at your disposal.

Additional to this instruction manual, three help programs are provided which will give you useful advice and support at any time how to operate your BERNINA 770 QE PLUS.

The **Tutorial** gives information and explanations, covering various aspects of sewing, embroidering and the different stitches.

The **Sewing Consultant** informs you about decision support for sewing projects. After entering the fabric and the desired sewing project, suggestions concerning the suitable needle and the appropriate presser foot are displayed.

The **Help Program** provides information about individual stitch patterns, functions and operations in the user interface.

Further information

In addition to this instruction manual for your BERNINA 770 QE PLUS the following information products are enclosed.

The current version of your manual as well as many other information about the machine and the accessories can be found on our website <https://www.bernina.com>

1.2 BERNINA Quality control

All BERNINA machines are assembled with utmost care and are subjected to an extensive functionality test. The integrated stitch counter therefore indicates that the machine has already sewn stitches, which were performed exclusively for test purposes and quality control. The subsequent thorough cleaning does not exclude the possibility that thread remnants may still be found in the machine.

1.3 Welcome to the world of BERNINA

Made to create, this is the slogan of BERNINA. Not only with our machines do we support you in the implementation of your ideas. In addition to the offers listed below, we offer you lots of suggestions and instructions for your future projects as well as the opportunity to exchange ideas with other sewing, quilting and embroidery enthusiasts. I wish you lots of pleasure.

BERNINA YouTube Channel

On YouTube we offer a wide range of how-to videos and support concerning the most important functions of our machines. You can also find detailed explanations many presser feet, meaning that your projects will be a complete success.

<https://www.youtube.com/BerninaInternational>

Available in English and German.

inspiration – the sewing magazine in the online shop

Are you looking for ideas, sewing patterns and instructions for great sewing projects? In this case, the BERNINA magazine «inspiration» is exactly what you need. Three times a year, inspiration offers fantastic sewing and embroidery ideas. From seasonal fashion trends to trendy accessories and practical tips to original decorations for your home or cute sewing ideas for children.



The magazine is available in English, German, Dutch, and French.

In our online shop you can purchase "inspiration" as an e-magazine or as a print version, either as individual issues or as a subscription. Furthermore, there are many individual downloadable cutting patterns to discover! Please have a look at <https://www.bernina.com/inspiration>

BERNINA Blog

Subtle instructions, free sewing patterns and embroidery motifs as well as many new ideas: All this you can find in the weekly blog of BERNINA. Our experts give useful tips and explain step by step how you can achieve the desired result. In the community you can upload your own projects and exchange experiences and ideas with other sewing and embroidering enthusiasts.

<https://www.bernina.com/blog>

Provided in English, German and Dutch.

BERNINA Social Media

Follow on social networks to learn more about events, thrilling projects as well as tips and tricks all about sewing, quilting and embroidering. We keep updated and we are happy to show you one or two highlights from the world of BERNINA.

<https://www.bernina.com/social-media>



1.4 Overview Machine

Overview front controls



- | | | | |
|---|------------------------|----|-----------------------------|
| 1 | «Quick Reverse» | 7 | «Pattern Begin» |
| 2 | «Thread Cutter» | 8 | «Needle Up/Down» |
| 3 | «Presser Foot Up/Down» | 9 | «Upper Multi-function knob» |
| 4 | «Start/Stop» | 10 | «Lower Multi-function knob» |
| 5 | «Pattern End» | 11 | «Needle Left/Right» |
| 6 | «Securing» | | |

Overview front



- | | | | |
|---|---|----|---------------------------------|
| 1 | Connection for embroidery module | 7 | Slide speed control |
| 2 | Bobbin cover | 8 | Thread take-up lever cover |
| 3 | Connection for accessory (optional accessory) | 9 | Thread take-up lever |
| 4 | Presser foot | 10 | Fixing screw |
| 5 | Needle threader | 11 | Connection for slide-on table |
| 6 | Sewing light | 12 | Connection for Free Hand System |



Overview sideways



- | | | | |
|---|--|----|-----------------------------------|
| 1 | Connection for foot control | 7 | Power switch |
| 2 | PC-connection | 8 | Connection for power cable |
| 3 | Spool holder | 9 | Magnet holder for touchscreen pen |
| 4 | Bobbin winding unit with thread cutter | 10 | Air vents |
| 5 | Swiveling spool holder | 11 | USB port |
| 6 | Handwheel | 12 | Feed dog up/down |

Overview - Back panel



- | | | | |
|---|-------------------------------|----|--------------------------|
| 1 | Connection for Slide-on Table | 8 | Carry Handle |
| 2 | Connection for Darning Hoop | 9 | Bobbin Winder Pretension |
| 3 | BSR connection | 10 | Thread Guide |
| 4 | Connection for accessory | 11 | BDF BERNINA Dual Feed |
| 5 | Air Vents | 12 | Thread Cutter |
| 6 | Thread Guide | 13 | Feed Dog |
| 7 | Bobbin Winding Unit | 14 | Stitch Plate |

1.5 Supplied accessories

Overview accessories machine





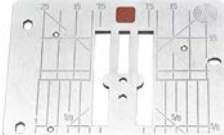



Illustration	Name	Purpose
	Dust cover	To protect the machine from dust and contamination.
	Accessories box	To store the supplied accessories as well as the optional accessories.
	Free Hand System (FHS)	To raise and lower the presser foot.
	Slide-on Table	To increase the sewing surface.
	CutWork/Straight stitch plate	To sew straight stitches and for CutWork.
	Spool disc	To support the regular unwinding of the thread from the spool.
	Bobbin Set of 5	To wind the bobbin thread.
	Foam pad 2 pieces	The foam pad prevents the thread from slipping, tangling or breaking on the spool pin.













Illustration	Name	Purpose
	Touchscreen pen	For precise operation of the touch display.
	Seam ripper	To undo seams and to cut buttonholes open.
	Height compensating tool	To level an angled position of the presser foot sole when sliding over thick seams.
	Selection of needles	For any common applications.
	Seam guide, right	To align regular seam distances.
	Screwdriver Torx, gray	To change the needle.
	Screwdriver red (slot)	To loosen and tighten slotted screws.
	Angular Torx wrench Torx	To open the headframe.
	Brush	To clean the feed dog and the looper area.
	Sewing machine oil	To oil the machine.

Illustration	Name	Purpose
	Power cable	To connect the machine with the power supply system.
	Foot control	To start and stop the machine. To control the sewing speed.

Overview presser feet

Supplied standard presser feet








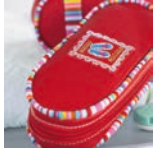






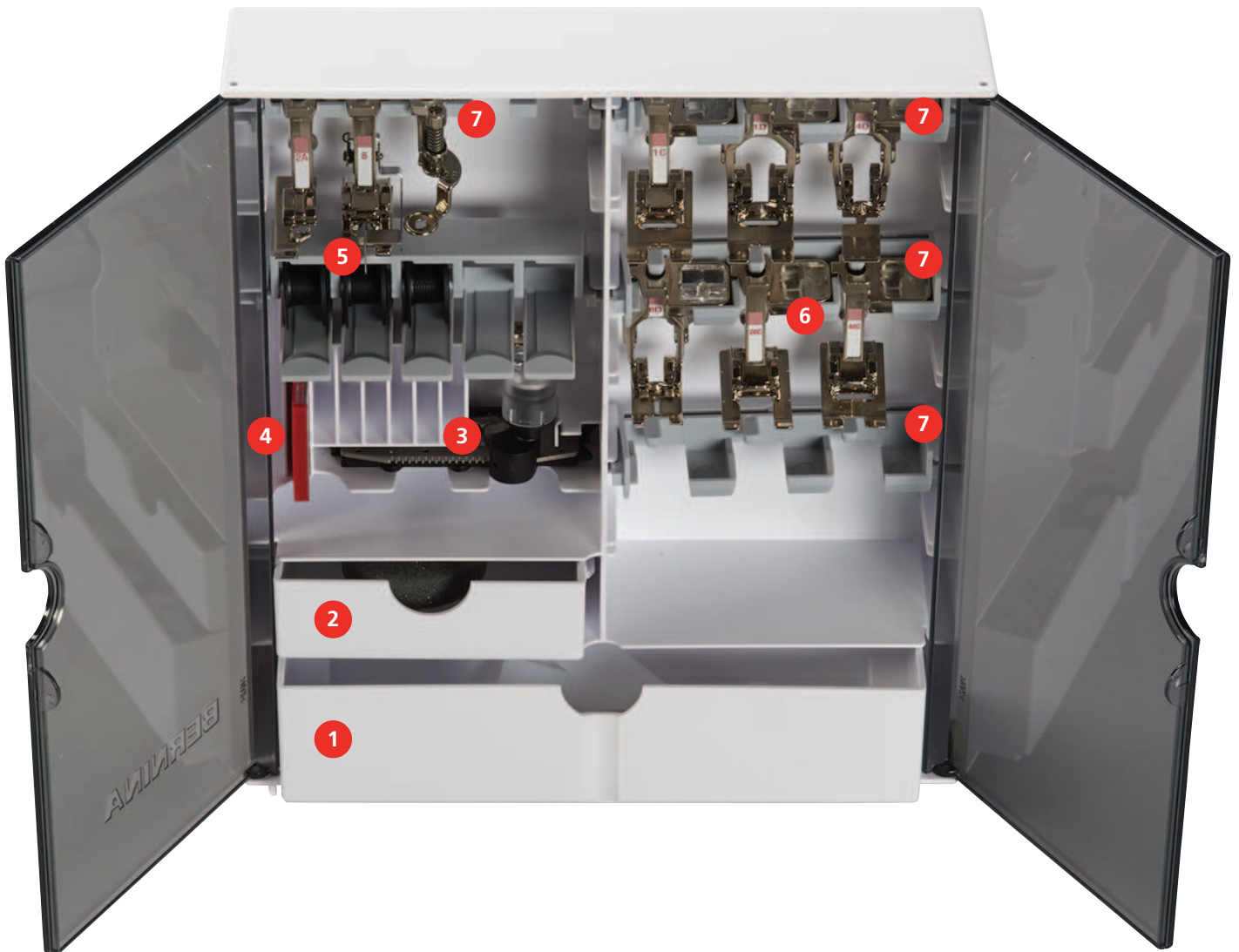
Illustration	Number	Name	Purpose	Example
	#1C	Reverse Pattern Foot	To sew various practical and decorative stitches. To sew forward and in reverse.	
	#1D	Reverse Pattern Foot	To sew various practical and decorative stitches with Dual Feed. To sew forward and in reverse.	
	#3A	Automatic Buttonhole Foot with Slide	To sew buttonholes automatically.	
	#4D	Zipper Foot	To sew in zippers with Dual Feed.	
	#20C	Open Embroidery Foot	To sew appliqués and decorative patterns.	

Illustration	Number	Name	Purpose	Example
	#42	BERNINA Stitch Regulator (BSR)	Free-motion quilting with regular stitch length.	
	#97D	Patchwork Foot	For patchwork and other exact work, if working with BERNINA Dual Feed.	



Accessory box

In the accessory box, accessories can be neatly stored in compartments and matching holders.



- | | | | |
|---|----------------------------|---|---|
| 1 | Big drawer | 5 | Spool Pin |
| 2 | Small drawer | 6 | Presser Feet |
| 3 | Buttonhole foot with slide | 7 | Presser Foot Holders for 5.5 mm and 9.0 mm feet |
| 4 | Selection of needles | | |

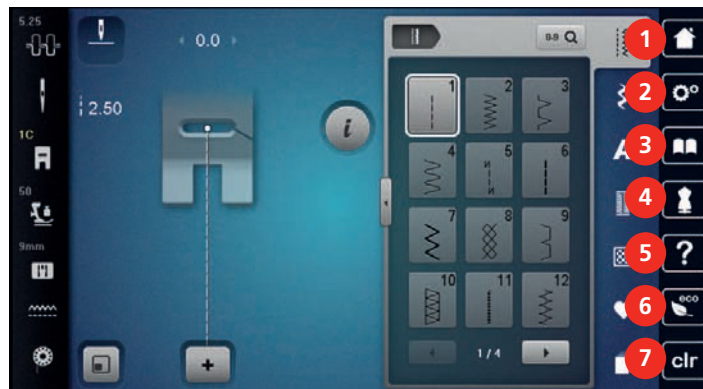
1.6 Overview User Interface

Overview functions/visual information



- | | | | |
|---|---|---|--------------------------|
| 1 | «Upper Thread Tension» | 5 | «Stitch Plate Selection» |
| 2 | «Needle Selection» | 6 | «Feed Dog Up/Down» |
| 3 | «Presser foot indicator / presser foot selection» | 7 | «Bobbin Thread» |
| 4 | «Presser Foot Pressure» | | |

Overview System settings



- | | | | |
|---|-----------------------|---|------------------|
| 1 | «Home» | 5 | «Help» |
| 2 | «Setup Program» | 6 | «eco Mode» |
| 3 | «Tutorial» | 7 | «Clear Settings» |
| 4 | «Creative Consultant» | | |

Overview selection menu sewing



- | | | | |
|---|-----------------------|---|-------------------|
| 1 | «Practical Stitches» | 5 | «Quilt Stitches» |
| 2 | «Decorative Stitches» | 6 | «Personal Memory» |
| 3 | «Alphabets» | 7 | «History» |
| 4 | «Buttonholes» | | |

Software operation

The touch-sensitive screen can be operated with the finger or stylus.

Tap: Short tap of an element.





Swipe: Tap an element and swipe quickly on the screen.

Draw: Tap the screen and slowly move in one direction, eg. for scrolling up and down.


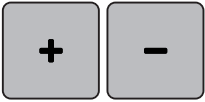

Navigation

Illustration	Name	Purpose
	«Home»	Switch between «Home screen» and «Sewing screen».
	Navigation path	Show a previous menu level.
	«Close»	Close the window.
	More	Show more features or information.
	Continue	Scroll to next display.
	Back	Scroll to previous display.

Activate/deactivate functions

Figure	Element	Status
	Switch	Function is activated.
		Function is deactivated.
	Icon	Function ist deactivated.
		Function ist activated.

Adjust values

Illustration	Name	Purpose
	Slider control	Set the value with the slider control. Reset the value to the default value by tapping the small bullet.
	Field «Plus» / «Minus»	«Plus» increase, «Minus» reduce the value.
	Yellow frame	Indication that the set value differs from the default value. Reset the value to the default value by tapping.

Enter text and numbers

To enter numerical values or text, a corresponding keyboard is shown.











Illustration	Name	Purpose
	Entry field	Display of the entry. Delete all characters entered with a single tap.

Illustration	Name	Purpose
	«Delete»	Delete the last character.
	«Lower Case Characters»	Show the available letters in lower case letters.
	«Upper Case Characters»	Show the available letters in upper case letters.
	«Numbers and Mathematical Characters»	Show the available numbers and mathematical characters.
	«Special Characters»	Show the available special characters.
	«Confirm»	Confirm the entry and leave the submenu.
	«Cancel»	Cancel the entry and the view closes.

1.7 Needle, Thread, Fabric

In the course of time a needle wears out. Therefore it should be replaced regularly. Only a perfect point results in a good stitching result. In general it can be said: the thinner the thread, the finer the needle. The illustrated needles are either standard or optional accessory, depending on the machine.

- Needle sizes 70, 75: for thin fabrics.
- Needle sizes 80, 90: for medium fabrics.
- Needle sizes 100, 110 and 120: for heavy fabrics.

Overview Needles

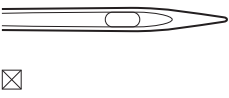
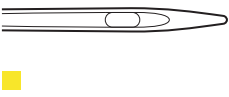
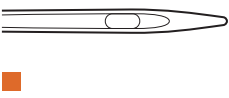
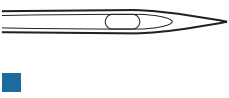
Illustration	Needle name	Needle description	Purpose
	Universal needle 130/705 H 60-120	Slightly rounded point	For nearly all natural and synthetic fabrics (woven and knitted).
	Stretch needle 130/705 H-S 75, 90	Mid-sized ball point, special eye shape and needle scarf	For jersey, tricot, knit and stretch fabrics.
	Jersey/Embroidery needle 130/705 H SUK 60-100	Mid-sized ball point	For knitware, knitted good. For embroidering.
	Jeans needle 130/705 H-J 80-110	Point, narrow point, reinforced shaft	For heavy-weight fabrics such as jeans or canvas.

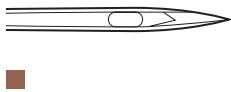
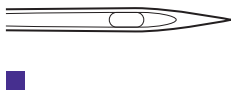
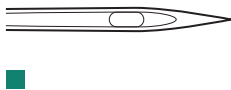
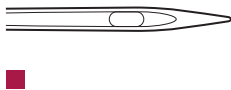
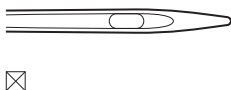
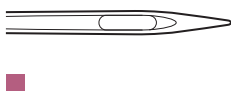
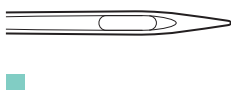

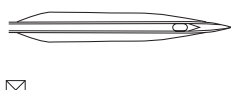
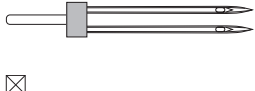
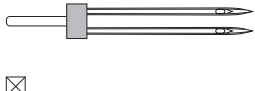


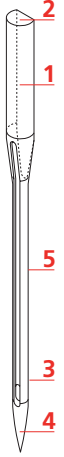
Illustration	Needle name	Needle description	Purpose
	Leather needle 130/705 H LR 90, 100	With cutting point (LR = special point to sew leather)	For all types of leather, synthetic leather, plastic, sheeting.
	Microtex needle 130/705 H-M 60-110	Especially sharp, narrow point	For micro fiber fabrics and silk.
	Quilting needle 130/705 H-Q 75, 90	Slightly rounded fine point	For straight and topstitching.
	Embroidery needle 130/705 H-E 75, 90	Small ball point, especially wide needle eye and wide thread groove	For embroidery on all natural and synthetic fabrics.
	Fine-material needle 130/705 H SES 70, 90	Small ball point	For fine knitware and knitted materials. For embroidery on fine, delicate fabrics.
	Metafil needle 130/705 H METAFIL 80	Long needle eye (2 mm) in all needle sizes	For sewing or embroidering with metallic threads.
	Cordonnet needle (to patch embroidery) 130/705 H-N 70-100	Long needle eye (2 mm) in all needle sizes	Topstitching with thick thread.
	Felt needle PUNCH	Needle with barbed hook	For felt work.
	Hemstitch needle 130/705 H WING 100-120	Wing-like widened needle shaft (wing)	To sew blind stitches.
	Universal double needle 130/705 H ZWI 70-100	Needle distance: 1.0/1.6/2.0/2.5/3.0/4.0/6.0/8.0	For visible hems in stretch fabrics, pintucks, decorative sewing.
	Stretch double needle 130/705 H-S ZWI 75	Needle distance: 2.5/4.0	For visible hems in stretch fabrics, pintucks, decorative sewing.

Illustration	Needle name	Needle description	Purpose
 <input checked="" type="checkbox"/>	Hemstitch double needle 130/705 H ZWIHO 100	Needle distance: 2.5	For special effects with hemstitch embroidery.
 <input checked="" type="checkbox"/>	Universal triple needle 130/705 H DRI 80	Needle distance: 3.0	For visible hems in stretch fabrics, decorative sewing.

Example for needle description

The 130/705 system, which is the most common for household machines, is explained by the following picture of a Jersey/Stretch needle.

	<p>130/705 H-S/70</p> <p>130 = Shank length (1)</p> <p>705 = Flat shank (2)</p> <p>H = Needle scarf (3)</p> <p>S = Needle point (here medium ball point) (4)</p> <p>70 = Needle size 0.7 mm (5)</p>
--	---

Thread selection

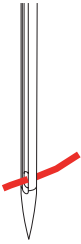
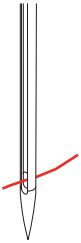
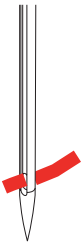
For a perfect sewing result, thread and fabric quality play an important role.

We recommend purchasing quality threads to achieve good sewing results.

- Cotton threads have the advantage of being a natural fiber and therefore are especially suitable for sewing cotton fabrics.
- Mercerized cotton threads have a slight sheen that is not lost with washing.
- Polyester threads have a high tensile strength and is particularly colorfast.
- Polyester threads are more flexible and are recommended where a strong and elastic seam is required.
- Rayon threads are made of natural fibers and have a brilliant sheen.
- Rayon threads are suitable for decorative stitches and achieve a more beautiful effect.



Needle/thread combination

	<p>The needle/thread combination is correct, when the thread fits perfectly into the long groove and goes easily through the needle eye. The thread can be optimally secured.</p>
	<p>The thread can break and skipped stitches can occur when there is too much clearance in the long groove and the needle eye.</p>
	<p>The thread can break and get stuck when the thread scrapes against the edge of the long groove not fit well into the needle eye optimally.</p>

2 Sewing preparation

2.1 Before using the machine for the first time



BERNINA recommends lubricating the hook before using the machine for the first time or after a longer period of non-use. (see page 173)

By oiling the hook, the occurrence of unwanted noises in the hook area can be avoided.

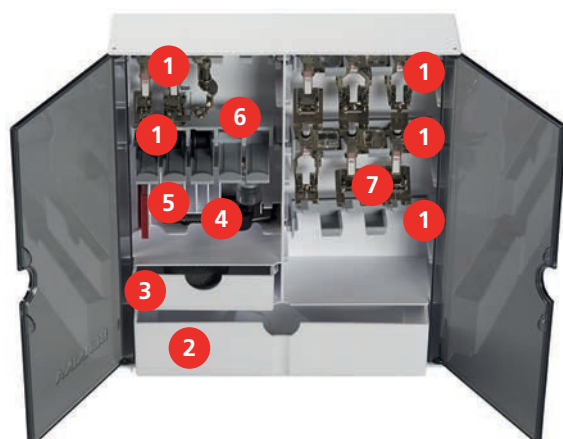
2.2 Accessory box

Accessory box free standing

> On the back of the box, pull both extensions out until they click into place.



Storing accessory



- > Insert the holders (1) for bobbins, presser feet and needles into the accessory box.
- > Store the presser feet in the holders (7) (5.5 mm or 9.0 mm).
- > Store the small parts, e.g. thread discs etc., in the drawers (2) and (3).
- > Buttonhole foot with slide #3A in compartment (4).
- > Store the provided needle package in the special compartment (5).

NOTICE

Scratched sensor surfaces of the bobbin

Malfunction of the lower thread indicator. If the sensor surfaces of the bobbins are scratched or dirty, the bobbin thread indicator will no longer detect the low thread level.

- > Always position the bobbins in the bobbin holder with the silver sensor surface to the right.

- > Position the bobbins in the bobbin holder (6) with the silver sensor surface to the right.
- > To remove a bobbin, press the compartment holder down.

2.3 Connection and Switching on**Connecting the foot control**

The cable of the foot control is rolled up on its underside.

- > Unroll the cable of the foot control to the desired length and fix it in the cable holders of the foot control..



- > Insert the plug of the cable into the foot control socket of the machine.



- > Place the foot control under the table.
- > If the cable is too long, roll up the excess length and fix it in the cable holders of the foot control.

Connecting the machine

To ensure safe operation of the machine, only the supplied mains cable may be used. The supplied power cable is designed for the voltage range applicable in the country of use. If the machine is to be used in a country other than the country of origin, the power cable suitable for that country must be obtained from the Authorized BERNINA dealer.

The power cable for USA and Canada has a polarized plug (one blade wider than the other). To reduce the risk of electrical shock, this plug is intended to fit in a polarized outlet only one way. If the plug does not fit into the outlet, turn the plug upside down and plug it in. If it still does not fit, contact a qualified electrician to install the proper outlet. Do not modify the plug in any way.

- > Insert the device connector of the power cable into the machine's power cable connection.



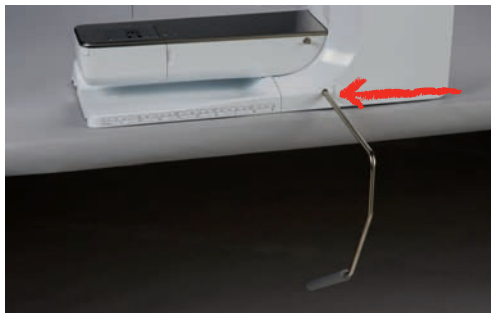
- > Insert the power plug of the power cable into the socket.

Attaching the knee lifter of the Free Hand System



The lateral position of the knee lifter can be adjusted by your local BERNINA Dealer if required.

- > Insert the knee lifter into the opening at the front side of the machine.
- > Adjust the sitting height so that the knee lifter can be operated with the knee.



Fixing the touchscreen pen

- > Store the touchscreen pen at the magnet holder.



Switching the machine on

- > Set the Power Switch to «I».



2.4 Foot control

Regulating the speed via the foot control

Via the foot control the speed can be adjusted infinitely variable.

- > Press the foot control down carefully to start the machine.
- > To sew faster, press the foot control harder.
- > Release the foot control to stop the machine.



Activate/deactivate additional function

The foot control can be programmed with a second function which can be activated and deactivated with a Back-kick. On delivery, the Back-kick is programmed with the function «Needle Up/Down».

- > To raise or lower the needle, press the foot control downward with your heel.



The Back-kick function can be programmed individually. (see page 54)

2.5 Spool pin

Swiveling spool pin

Installing the spool holder



With metallic or other special threads, it is recommend to use the swiveling spool pin.

The swiveling spool holder is necessary when several threads are sewn and it can also be used for bobbin winding while sewing.

- > Swivel the spool holder up as far as it will go.



Inserting foam pad and thread spool

The foam pad prevents the thread from getting hooked at the swiveling spool holder.

- > Place the foam pad on the swiveling spool holder.
- > Place the thread spool on the spool holder.



Horizontal spool pin

Placing the foam pad, the thread spool and the spool disc

The spool disc provides an even unwinding of the thread from the thread spool. The spool disc is only used with the horizontal spool pin.

- > Place the foam pad on the spool pin.
- > Place the thread spool on the spool pin.



2.8 Slide-on table

Using the slide-on table

The Slide-on Freearm Extension Table, attached to the freearm, enables the available sewing area to be extended.

- > Raise the needle.
- > Raise the presser foot.
- > Switch off the machine and disconnect it from the power supply.
- > Push the Slide-on Freearm Extension Table from the left to the right over the freearm until it engages.



- > To remove the slide-on table, press the button at the table down and pull the slide-on table over the free arm to the left.



2.9 Presser foot

Adjusting the presser foot position via the knee lifter of the Free Hand System

- > Adjust the sitting height so that the knee lifter can be operated with the knee.
- > Push the knee lifter with the knee to the right to raise the presser foot.



- Simultaneously the feed dog is lowered and the thread tension is released.
- > Release the knee lifter slowly to lower the presser foot.

Adjusting the presser foot position via the button «Presser foot up/down»



- > To raise the presser foot, push the button «Presser Foot Up/Down».
- > To lower the presser foot, push the button «Presser Foot Up/Down» again.

Changing the presser foot

- > Raise the needle.
- > Raise the presser foot.
- > Switch the machine off and disconnect it from the power supply system.

- > Push the clamping lever up.



- > Remove the presser foot.
- > Guide the new presser foot upwards over the cone.
- > Press the clamping lever down.

Selecting the presser foot in the User Interface

After changing the presser foot, a check can be performed to determine whether it is suitable for the selected stitch pattern. Additionally, alternative presser feet are displayed, which are available for the selected stitch pattern.

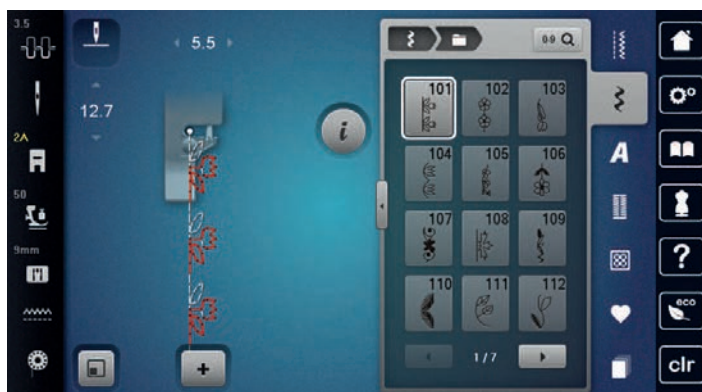
- > Switch the machine on.
- > Select a stitch pattern.
- > Tap «Presser foot indicator / presser foot selection».



- > To display all suitable presser feet for the selected stitch pattern, tap «Optional Presser Feet».



- > Select the attached presser foot.
 - When the selected presser foot is suitable, sewing can start.
 - If the selected presser foot is not suitable for the selected stitch pattern, it can still be selected but the machine is automatically prevented from starting. An error message is displayed. If an incorrect presser foot is selected, the sewing stitch is displayed in red in the sewing stitch preview.



Adjusting the presser foot pressure



The presser foot pressure is designed to adjust the pressure of the presser foot optimally to the fabric thickness. When working with thick fabrics, it is recommended to reduce the presser foot pressure. This provides the advantage that the presser foot is slightly lifted so that the fabric can be moved more easily. When working with thin fabrics, it is recommended to increase the presser foot pressure. This provides the advantage that the fabric cannot be moved too easily under the presser foot.



- > Tap «Presser Foot Pressure».
- > Adjust the Presser Foot Pressure.

2.10 Needle and stitch plate

Changing the needle

- > Raise the needle.
- > Switch the machine off and disconnect it from the power supply system.
- > Remove the presser foot.
- > Loosen the fixing screw of the needle using the screwdriver gray Torx.



- > Pull the needle down.
- > Hold the new needle with the flat side to the back.
- > Insert the needle as far as it will go.
- > Tighten the fixing screw of the needle using the screwdriver gray Torx.

Selecting the needle in the User Interface

After changing the needle, you can check whether this can be used with the selected stitch plate.



- > Tap «Needle Selection».
- > Select the fitted needle.



- When the selected needle matches the selected presser foot, sewing can be started. If the selected needle does not match the selected presser foot, there will be an error message when starting the machine and the machine will not sew.

Selecting needle type and needle size

Convenient memory function: To prevent a loss of information, the needle type and the needle size can be saved additionally on the machine. The saved needle type and the saved needle size can be checked at any time.



- > Tap «Needle Selection».



- > Tap «Needle Information».
- > Select the needle type (1) of the fitted needle.
- > Select the needle type (2) of the fitted needle.



Adjusting the needle position up/down



- > To lower the needle, push the button «Needle Up/Down».
- > To raise the needle, push the button «Needle Up/Down» again.

Adjusting the needle position left/right

There is a total of 11 needle positions. The needle position is indicated by the needle position number in the display.

- > To position the needle position to the left, push the button «Needle left» (1).
- > To position the needle position to the right, push the button «Needle right» (2).



Needle stop up/down (permanent)



- > To set the needle stop position permanently, tap «Needle Stop Up/Down».
 - The machine stops with needle position down as soon as the foot control is released or the button «Start/Stop» has been pushed.
- > Tap «Needle Stop Up/Down» again.
 - The machine stops with needle position up as soon as the foot control is released or the button «Start/Stop» has been pushed.

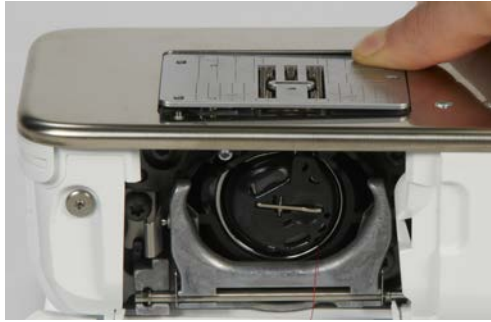
Changing the stitch plate

The stitch plate is marked with vertical, horizontal and diagonal lines in millimeters (mm) and inches (inch). These markings are helpful for sewing or precise top-stitching.

Prerequisite:

- The feed dog is lowered.
- The machine is switched off and disconnected from the power supply.
- The needle and presser foot are removed.

- > At the marking on the rear of the stitch plate, push the stitch plate downwards until it tips.



- > Remove the stitch plate.
- > Place the openings of the new stitch plate above the corresponding guide pins and press down until it clicks into place.

Selecting the stitch plate in the User Interface

After changing the stitch plate, you can check whether this can be used with the selected needle.

- > Tap «Stitch Plate Selection».
- > Select the previously fitted stitch plate.



- If the selected stitch plate is suitable to be used in combination with the needle, sewing can begin.
- If the selected stitch plate is not suitable to be used in combination with the needle, an error message is displayed and starting the machine is automatically prevented.

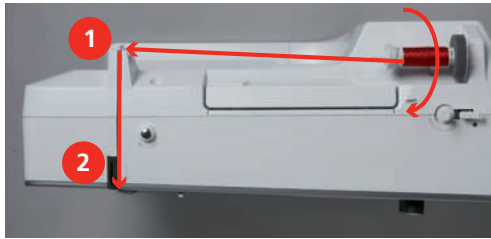
2.11 Threading

Threading the upper thread

Prerequisite:

- The needle and the presser foot are raised.
- The machine is switched off and disconnected from the power supply system.
- > Place the foam pad on the spool holder.
- > Place the thread spool on the spool holder so that the thread unwinds clockwise.
- > Add the appropriate spool disc.
- > Guide the thread in direction of the arrow through the rear thread guide (1) and hold the thread with the hands so that it is taut and can be inserted into the thread tension.

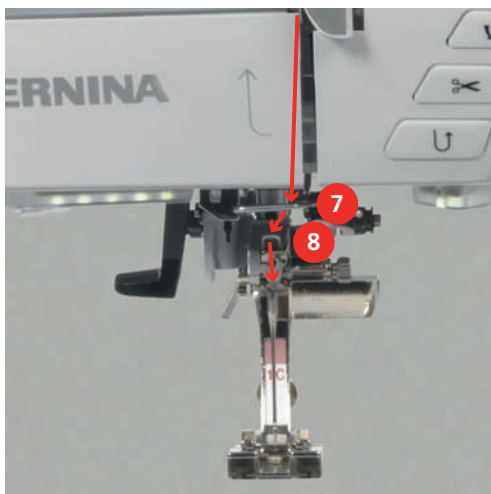
- > Guide the thread in direction of the arrow through the thread tension (2).



- > Guide the thread downwards (3) around the thread take-up lever cover (4).
- > Guide the thread upwards and insert into the thread take-up lever (5).
- > Guide the thread downwards again (6).



- > Guide the thread through the guides (7/8) above the presser foot.



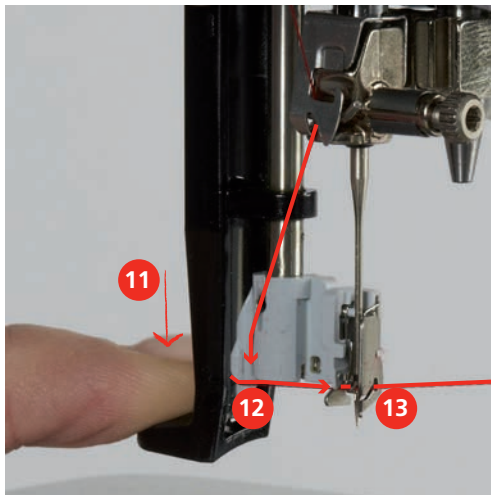
- > Switch the machine on.



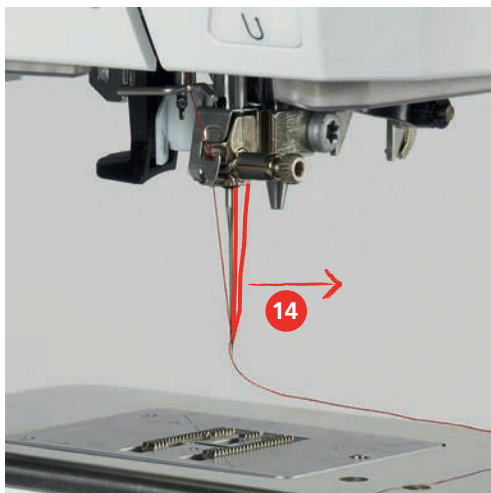
- > Press the semi-automatic threader lever (9) slightly down, keep pressed and pull the thread to the left beneath the gray threader hook (10).



- > Guide the thread around the gray threader hook from the left to the right (12).
- > Press the threader lever down as far as it will go (11) and then pull the thread from the left to the right (12) through the threader slot (13) until it hooks into the small wire hook.



- > Release the lever and the thread simultaneously to thread.
- > Pull the thread loop (14) to the back.



- > Pull the thread beneath the presser foot from back to front over the thread cutter (15) and cut.



Threading the double needle

Prerequisite:

- The double needle is inserted.
- > Guide the first thread in direction of the arrow on the right side of the tension disc (1).
- > Guide the second thread in direction of the arrow on the left side of the tension disc (1).



- > Guide the first and the second thread to the thread guide above the needle.
- > Thread the first thread manually into the right needle.
- > Thread the second thread manually into the left needle.



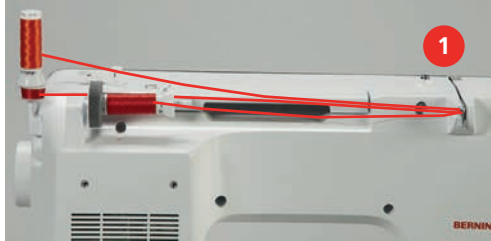
Threading the triple needle

Prerequisite:

- The triple needle is inserted.



- > Place the foam pad, the thread spool and the appropriate spool disc on the spool holder.
- > Place the filled bobbin on the swiveling spool holder.
- > Fit the appropriate thread disc.
- > Place the thread spool.
- > Thread the 3 threads up to the upper thread guide.



- > Guide 2 threads past the thread tension discs (1) on the left and to the thread guide above the needle.
- > Guide 1 thread past the thread tension discs (1) on the right and to the thread guide above the needle.
- > Thread the first thread into the left needle manually.
- > Thread the second thread into the center needle manually.
- > Thread the third thread into the right needle manually.

Winding the bobbin thread



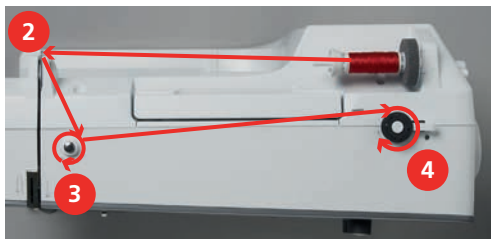
The bobbin thread can be wound while embroidering if the swiveling spool holder is used for winding.

Prerequisite:

- The foam pad, the thread spool and the appropriate spool disc are fitted.
- > Place the empty bobbin on the Winding Unit (1) so that the silvery sensor surface is down.



- > Guide the thread to the left into the rear thread guide (2).
- > Guide the thread around the bobbin winder pretension clockwise (3).
- > Wind the thread clockwise 2 – 3 times around the empty bobbin (4).



- > Pull the excess thread over the thread cutter at the engaging lever (5) and cut.



- > Push the engaging lever (6) towards the bobbin.

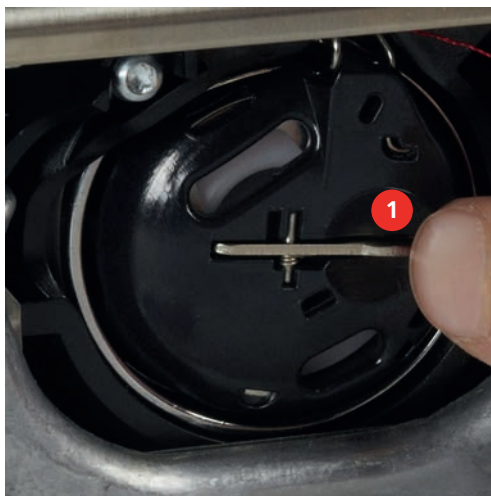


- The machine winds and the display to wind the bobbin appears.
- > Set winding speed.
- > To stop the winding process, the engaging lever must be pushed to the right.
- > Push the engaging lever towards the bobbin again to continue the winding process.
 - As soon as the bobbin is full, the machine stops the winding process automatically.
- > Remove the bobbin and cut the thread using the thread cutter at the engaging lever.

Threading the bobbin thread

Prerequisite:

- The needle is raised.
- The machine is switched off and the bobbin cover is opened.
- > Press the bobbin case release at the bobbin case (1).



- > Remove the bobbin case.
- > Remove the bobbin from the bobbin case.

- > Insert the new bobbin so that the silvery sensor surface is facing the back of the bobbin case.



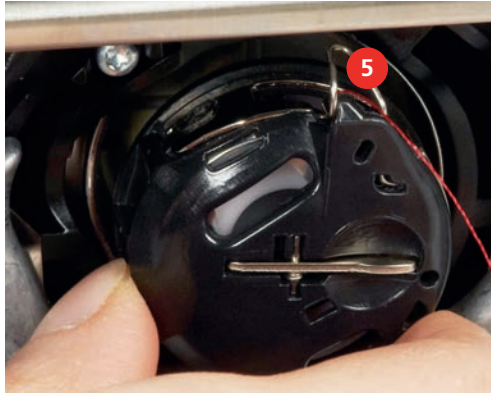
- > Pull the thread into the slot (2) from the left.



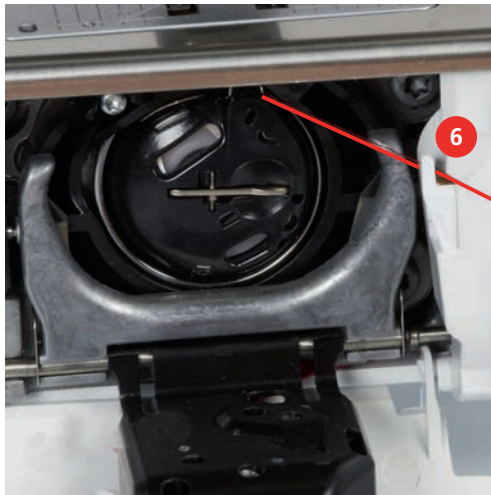
- > Pull the thread to the right under the spring (3), then lead the thread under the two thread guides (4) and pull upwards.



- > When inserting into the machine, hold the bobbin case so the thread guide (5) points upwards.



- > Insert the bobbin case.
- > Press onto the center of the bobbin case until it engages.
- > Pull the thread through the thread cutter (6) and cut.



- > Close the bobbin cover.

Indicating fill level of bobbin thread

When the fill level of the bobbin thread is low, an animation appears in the icon «Bobbin Thread» to indicate that the bobbin thread is about to run out.



- > To thread the bobbin thread according to the animation, tap, «Bobbin Thread».



3 Setup Program

3.1 Sewing settings

Adjusting the upper thread tension

Alterations of the upper thread tension in the Setup Program affect all stitch patterns. Individual alteration of the upper thread tension can also be made for currently selected stitches.



> Tap «Setup Program».



> Tap «Sewing settings».



> Tap «Upper Thread Tension».
> Adjust the upper thread tension.

Adjusting the maximum sewing speed

You can use this function to reduce the maximum speed.



> Tap «Setup Program».



> Tap «Sewing settings».



> Tap «Maximum Sewing Speed».
> Set the maximum sewing speed.

Programming the securing stitches

If the function is switched on, at the start of the pattern, 4 securing stitches are automatically sewn after the thread cut.



> Tap «Setup Program».



> Tap «Sewing settings».



> Tap the switch again to deactivate the securing stitches.
> Tap the switch again to activate the securing stitches.

Adjusting the hovering height of the presser foot

The hovering height of the presser foot can be adjusted according to the fabric thickness from 0 to maximal 7 mm.



Setup Program



> Tap «Setup Program».



> Tap «Sewing settings».



> Tap «Programming buttons and icons».



> Tap «Programming the Hovering Height of the presser foot».
> To adjust the distance between the fabric and the presser foot.

Programming the button «Pattern end»

The presser foot can be positioned, the thread cut and the automatic securing can be programmed.



> Tap «Setup Program».



> Tap «Sewing settings».



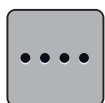
> Tap «Programming buttons and icons».



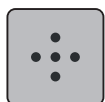
> Tap «Programming the button Pattern end».



> To sew 4 securing stitches in place, tap «Securing Stitches».



> To program subsequent securing stitches, tap «Securing stitches in close succession».
> To program the number of subsequent securing stitches, tap «Plus» or «Minus».



> To program 4 securing stitches in place, tap «Securing stitches in place».



> To deactivate the automatic thread cut after securing, tap «Automatic Thread Cutter».
> To activate the automatic thread cut after securing, tap «Automatic Thread Cutter» again.



> To keep the presser foot in lowered position, tap «Lift the presser foot».
> To raise the presser foot after securing, tap «Lift the presser foot» again.



> To deactivate the automatic securing, tap «Securing Stitches».
> To activate the automatic securing, tap «Securing Stitches» again.

Programming the button «Thread cutter»

The automatic securing can be programmed before the thread cut takes place.



> Tap «Setup Program».



> Tap «Sewing settings».



> Tap «Programming buttons and icons».



> Tap «Programming the button Thread cutter».



> To sew 4 securing stitches in place, tap «Securing Stitches».



> To program subsequent securing stitches, tap «Securing stitches in close succession».

> To program the number of securing stitches, tap «Minus» or «Plus».



> To program 4 securing stitches in place, tap «Securing stitches in place».



> To deactivate the automatic securing, tap «Securing Stitches».

> To activate the automatic securing, tap «Securing Stitches» again.

Adjusting the presser foot position with needle stop down

With lowered needle, 3 different presser foot position can be selected: the presser foot lowered, the presser foot is raised to hovering position and the presser foot is raised to its maximum height.



> Tap «Setup Program».



> Tap «Sewing settings».



> Tap «Programming buttons and icons».



> Tap «Pressure foot position with Needle Stop Down».



> Select the desired presser foot position.

Programming the button «Quick reverse»

You can choose between «Reverse sewing» and «Stitch-specific reverse sewing».



> Tap «Setup Program».



> Tap «Sewing settings».



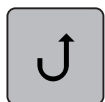
> Tap «Programming buttons and icons».



> Tap «Programming the button Quick reverse».



> To set the stitch-precise reverse sewing, tap «Backstepping».



> To set the stitch-precise reverse sewing, tap «Permanent Quick Reverse».

Programming the button «Securing»

The number and type of securing stitches can be programmed.



> Tap «Setup Program».



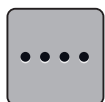
> Tap «Sewing settings».



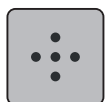
> Tap «Programming buttons and icons».



> Tap «Programming the button Securing».






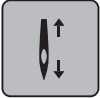


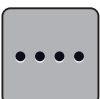




- > To program subsequent securing stitches, tap «Securing stitches in close succession».
- > To program the number of securing stitches, tap «Minus» or «Plus».



> To program 4 securing stitches in place, tap «Securing stitches in place».

Programming the foot control




When the icon «Needle up/down» is activated, the needle is raised or lowered via the Back-kick. Alternatively, the presser foot position, the thread cut and the automatic securing can be programmed.

-  > Tap «Setup Program».
-  > Tap «Sewing settings».
-  > Tap «Programming the foot control».
- 
 - «Needle up/down» is activated in the default setting.
 - The Back-kick on the foot control raises or lowers the needle.
-  > To program the Back-kick, tap «Programming the Back-kick».
-  > To sew 4 securing stitches in place, tap «Securing Stitches».
- 
 - > To program subsequent securing stitches, tap «Securing stitches in close succession».
 - > To program the number of securing stitches, tap «Minus» or «Plus».
-  > To program 4 securing stitches in place, tap «Securing stitches in place».
- 
 - > To deactivate the automatic securing via the Back-kick, tap «Securing Stitches».
 - > To activate the automatic securing via the Back-kick, tap «Securing Stitches» again.
- 
 - > To deactivate the automatic thread cut via the Back-kick, tap «Automatic Thread Cutter».
 - > To activate the automatic thread cut via the Back-kick, tap «Automatic Thread Cutter» again.
- 
 - > To keep the lowered position of the presser foot via the Back-kick, tap «Lift the presser foot».
 - > To keep the raised position of the presser foot via the Back-kick, tap «Lift the presser foot» again.

3.2 Embroidery settings

Adjusting the upper thread tension

Changes to the upper thread tension in the Setup Program affect all of the embroidery motifs.

-  > Tap «Setup Program».
-  > Tap «Embroidery settings».
- 
 - > Tap «Adjusting the upper thread tension».
 - > Adjust the upper thread tension.



Adjusting the maximum embroidering speed

You can use this function to reduce the maximum speed.



> Tap «Setup Program».



> Tap «Embroidery settings».



> Tap «Maximum Embroidery Speed».
> Set the maximum sewing speed.

Centering or opening embroidery motifs in the original position

When the embroidery motif is opened on the machine, it is always centered to the embroidery hoop. If you want the embroidery motif to be opened in its original position (defined by the BERNINA embroidery software), the function «Centering the embroidery motif» must be activated.



> Tap «Setup Program».



> Tap «Embroidery settings».



> Tap «Centering the embroidery motif».



> Tap the switch in the right section.
– A previously moved embroidery motif which has been saved in the new position is opened in the saved position after selecting.
> Tap the switch in the right section again.
– The embroidery motif is centered to the embroidery hoop.

Calibrating the embroidery hoop

The calibration of the embroidery hoop is the coordination of the needle to the center of the embroidery hoop.

Prerequisite:

- The Embroidery Module is connected and the embroidery hoop with the appropriate embroidery template is attached.



> Tap «Setup Program».



> Tap «Embroidery settings».

Programming the securing stitches

Embroidery motifs are programmed either with or without securing stitches. If an embroidery motif has programmed securing stitches, they will be embroidered. If the embroidery motif is programmed with securing stitches, the securing stitches can be removed in the BERNINA Embroidery Software.

The machine recognizes when no securing stitches are programmed and adds them. If no securing stitches are wanted, they can be deactivated.



> Tap «Setup Program».



> Tap «Embroidery settings».



> Tap «Securing Stitches».



> To deactivate the securing stitches at the start, switch off the switch in the upper section.
– If the embroidery motif doesn't have any programmed securing stitches, none are embroidered.



> Turn on the switch in the upper section to deactivate the securing stitches at the start.
– If the embroidery motif doesn't have any programmed securing stitches, the securing stitches are added and will be embroidered.



> Turn off the switch in the lower section to deactivate the securing stitches at the end.
– If the embroidery motif doesn't have any programmed securing stitches, none are embroidered.



> Turn on the switch in the lower section to activate the securing stitches at the end.
– If the embroidery motif doesn't have any programmed securing stitches, the securing stitches are added and will be embroidered.

Adjusting the thread cut



> Tap «Setup Program».



> Tap «Embroidery settings».



> Tap «Thread cut settings».



> To deactivate the automatic thread cut before changing a thread, tap the switch in the upper section of the display (1).

- > To activate the automatic thread cut before changing a thread, tap the switch in the upper section of the display (1) again.
- > Tap the switch in the middle section of the display (2) so that the machine will stop after about 7 stitches and the remaining thread can be cut manually.
- > Tap the switch in the middle section of the display (2) again and the machine won't stop for a manual thread cut.
- > To adjust the length from where the connecting stitches are cut, tap «Minus» or «Plus» (3).

Changing the measuring unit

The measuring unit in the Embroidery Mode can be changed from mm to inch. The standard setting is in mm.



- > Tap «Setup Program».



- > Tap «Embroidery settings».



- > Tap «Measuring unit».
- > To display the measurements in the Embroidery Mode in inch, tap «inch».
- > To display the measurements in the Embroidery Mode in mm, tap «mm».

3.3 Selecting personal settings



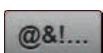
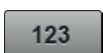
- > Tap «Setup Program».



- > Tap «Personal Settings».
- > Select the required display color and background.
- > Tap the text box above the color settings.



- > Enter the welcome message.
- > To use upper-case letters, tap «Upper Case Characters» (standard setting).
- > To use lower-case letters, tap «Lower Case Characters».
- > To use figures and mathematical symbols, tap «Numbers and Mathematical Characters».
- > To use special characters, tap «Special Characters».
- > Tap the text box above the keyboard to delete the entered text completely.





> To delete single syllables of the entered text, tap «Delete».



> Tap «Confirm».

3.4 Monitoring functions

Activating the upper thread indicator



> Tap «Setup Program».



> Tap «Monitoring Functions».



> Tap the switch in the upper section of the display to deactivate the upper thread indicator.
> Tap the switch again to activate the upper thread indicator.

Activating the bobbin thread indicator



> Tap «Setup Program».

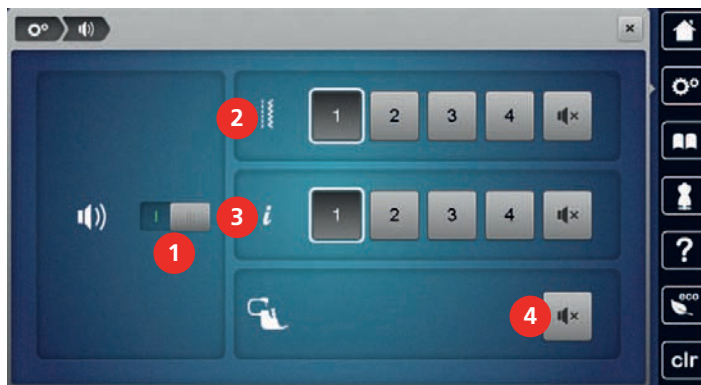


> Tap «Monitoring Functions».



> Tap the switch in the lower section of the display to deactivate the bobbin thread indicator.
> Tap the switch again to activate the bobbin thread indicator.

3.5 Activating the audio signals



> Tap «Setup Program».



> Tap «Set Sound».
> To switch all audio signals on or off, tap (1).



> To switch off the sound when selecting a stitch pattern, tap the corresponding «Switch Sounds On/Off» in area (2).
> To switch on the sound when selecting a stitch pattern, tap the corresponding in area_(2) «1 – 4».



> To switch off the sound for selecting functions, tap the corresponding «Switch Sounds On/Off» in area (3).

> To switch on the sound for selecting functions, tap the corresponding in area _(3) «1 – 4».



> To deactivate the sound of the beeper when using the BSR Modes, tap «Switch Sounds On/Off» in the sector (4).

3.6 Machine settings

Selecting a language

The User Interface can be programmed in different languages according to the customer's wish because BERNINA provides a wide range of international languages for the customers. Via firmware updates additional languages for the User Interface can be provided.



> Tap «Setup Program».



> Tap «Machine Settings».



> Tap «Language Selection».

> Select a language.

Adjusting the brightness of the display

The brightness of the display can be set to meet your individual needs.



> Tap «Setup Program».



> Tap «Machine Settings».



> Tap «Screen Settings».

> Adjust the brightness of the display in the upper section of the screen.

Adjusting the sewing light

You can set the brightness of the sewing light to meet your individual needs.



> Tap «Setup Program».



> Tap «Machine Settings».



> Tap «Screen Settings».

> Adjust the brightness of the sewing light in the lower section of the screen.



- > Tap the switch to switch the sewing light off.
- > Tap the switch again to switch the sewing light on.

Calibrating the display

Please find further information on this topic in the chapter attachment below troubleshooting at the end of the instruction manual.



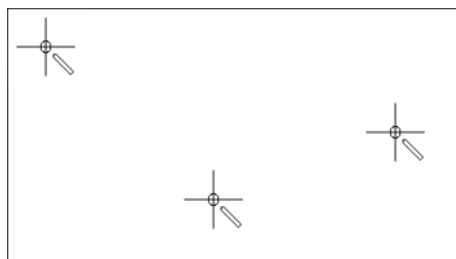
- > Tap «Setup Program».



- > Tap «Machine Settings».



- > Tap «Calibrate Screen».
- > Touch the crosses in sequence using the touchscreen pen.



Back to default setting

ATTENTION: Using this function will delete all individually made settings.



- > Tap «Setup Program».



- > Tap «Machine Settings».



- > Tap «Factory Setting».



- > To restore all default settings for sewing, tap «Default setting sewing» and confirm.



- > To restore all default settings for embroidering, tap «Default setting embroidering» and confirm.



- > To restore all default settings, tap «Default setting machine», confirm and restart the machine.

Deleting user data

Motifs which are not needed anymore can be deleted to create space for new motifs.



- > Tap «Setup Program».



- > Tap «Machine Settings».



> Tap «Factory Setting».



> To delete all data from the Personal Memory, tap «Delete data from own storage medium» and confirm.



> To delete all embroidery motifs from the Personal Memory, tap «Delete personal embroidery motifs» and confirm.

Deleting motifs on the BERNINA USB Stick

When motifs which won't be needed anymore are saved on the BERNINA USB Stick, the stick can be connected to the machine and the data can be deleted.

> Insert the BERNINA USB stick into the USB port of the machine.

> Tap «Setup Program».



> Tap «Machine Settings».



> Tap «Factory Setting».



> Tap «Deleting USB Stick».



> Tap «Confirm».

Calibrating the Buttonhole foot No. 3A

The Buttonhole foot with slide #3A is calibrated to the machine and they should only be used both together.

Prerequisite:

- The Buttonhole foot with slide #3A is fitted.
- The needle is not threaded.



> Tap «Setup Program».



> Tap «Machine Settings».



> Tap «Maintenance/Updates».



> Tap «Calibrating the Buttonhole foot #3A».



> To start the calibration, push the «Start/Stop» button.

Packing the embroidery module

To pack the embroidery module into the original packaging without moving the embroidery arm manually, the embroidery arm needs to be brought to its packing position.

Prerequisite:

- The embroidery module is connected with the machine.



> Tap «Setup Program».



> Tap «Machine Settings».



> Tap «Maintenance/Updates».



> Tap «Packing position».
> Follow the instructions on the display.

Reviewing the total number of stitches

The total number of stitches by the machine and the number of stitches since the last maintenance carried out by a specialist BERNINA dealer are displayed.



> Tap «Setup Program».



> Tap «Machine Settings».



> Tap «Information».



> Tap «Machine Data».

Registering details of the dealer

The contact details for your specialized BERNINA dealer can be entered.



> Tap «Setup Program».



> Tap «Machine Settings».



> Tap «Information».



> To enter the dealer data, tap «Dealer Data».



> To enter the name of your specialized BERNINA dealer, tap «Name».



> To enter the address of the specialized BERNINA dealer, tap «Address».



> To enter the telephone number of the specialized BERNINA dealer, tap «Phone Number».



> To enter the website or e-mail address of the specialized BERNINA dealer, tap «E-mail Address».

Saving Service data

The service data regarding the current status of the machine can be saved on a USB stick and consequently provided to the specialized BERNINA dealer.

> Insert a USB stick which provides enough free capacity into the USB port of the machine.

> Tap «Setup Program».



> Tap «Machine Settings».



> Tap «Information».



> Tap «Service Data».

> Tap «Export the service data».

– The icon «Export the service data» is outlined in white.

> If the white frame is no longer displayed, remove the USB stick.

Display machine ID

The machine ID is required in order to generate the activation key.



Prerequisite:

- The most up-to-date firmware version is installed on the machine. See support page <https://www.bernina.com/770qeplus-support>.



> Tap «Setup Program».

Setup Program



> Tap «Machine Settings».



> Tap «Information».



> Tap «Machine ID».

– The machine ID is displayed.

– If the «Machine ID» is not displayed, the most up-to-date version of the firmware must first be installed on the machine.



4 System settings

4.1 Calling up the Tutorial

The Tutorial gives information and explanations, covering various aspects of sewing, embroidering and the different stitches.



- > Tap «Tutorial».
- > Select the desired topic in order to view information.

4.2 Calling up the Creative Consultant

The Creative Consultant provides information about decision support concerning sewing projects. After entering the fabric and the desired sewing project, suggestions for suitable needles, presser feet etc. are displayed.



- > Tap «Creative Consultant».
- > Select the fabric on which you want to sew.
- > Select the sewing project.

4.3 Calling up the Help

- > Touch the window in the display where help is needed.
- > To start the Help Mode, tap «Help» twice.
- > Tap the icon in the display where help is needed.



4.4 Using eco mode

During a longer interruption of work the machine can be set into a power save mode. The power save mode also serves as a child safety feature. Nothing can be selected in the display and the machine cannot be started.



- > To activate the power save mode, tap «eco Mode».
 - The display goes to sleep. The power consumption is reduced and the sewing light is off.
- > To deactivate the power save mode, tap «eco Mode» again.

4.5 Cancelling any alterations with «clr»

Any alterations to motifs can be reset to basic setting. Exceptions are saved motifs which have been filed in the personal memory and monitoring functions.



- > Tap «Clear Settings».

5 Creative sewing

5.1 Overview selection menu sewing



- | | | | |
|---|-----------------------|---|-------------------|
| 1 | «Practical Stitches» | 5 | «Quilt Stitches» |
| 2 | «Decorative Stitches» | 6 | «Personal Memory» |
| 3 | «Alphabets» | 7 | «History» |
| 4 | «Buttonholes» | | |

Selecting a stitch pattern

- > Select a stitch pattern, alphabet or buttonhole.
- > To increase the view, tap «Increasing/Decreasing the display size» (1).



- > To decrease the view, tap «Increasing/Decreasing the display size» again.
- > To select the stitch pattern via the stitch number entry, tap «Stitch Pattern Selection via Number».

0-9 Q

5.2 BERNINA Dual Feed



It is recommended to match the presser foot pressure with the fabric. The thicker the fabric, the lower the presser foot pressure.

The BERNINA Dual Feed feeds the fabric from above and from beneath simultaneously. This provides an even and careful feed forward even for smooth and thin materials. Striped and checkered patterns can be matched perfectly by even feeding.

In general, the BERNINA Dual Feed is used for the following sewing projects:

- Sewing: All sewing applications with difficult fabrics such as for seams, zippers.
- Patchwork: With accurate stripes, blocks and with decorative stitches up to a stitch width of 9 mm.

- Appliqués: sewing appliques, ribbons and bias binding.

Difficult-to-work-with fabrics are:

- Velvet, normally sewn with the grain.
- Toweling.
- Jersey, especially when sewing it crosswise to knit.
- Fake fur or coated fake fur.
- Fleece-types of fabrics.
- Batted fabrics.
- Stripes and checks.
- Curtain fabrics with pattern repeats.

«Sticky» fabrics are:

- Imitation leather, coated fabrics (optimally with optional accessory Zigzag Foot with Non-Stick Sole #52D).

Application of the BERNINA Dual Feed



Only use presser feet with a cut-out at the center back and the labeling «D». Additional presser feet with the labeling «D» are listed in the enclosed accessory catalog.

Activate Dual Feed

- > Raise the presser foot.
- > Attach a presser foot with the designation «D».
- > Pull the dual feed down until it engages.



Deactivate Dual Feed

- > Raise the presser foot.
- > Hold the dual feed by the handle with two fingers, pull it down and then push it away from you and let it slide slowly upwards.



5.3 Regulating the speed

The sewing speed can be adjusted infinitely variable with the slide.

- > Move the slide to the left to reduce the sewing speed.
- > Move the slide to the right to increase the sewing speed.

5.4 Adjusting the upper thread tension

The default setting of the upper thread tension is set automatically as soon as a stitch pattern or an embroidery motif is selected.

The upper thread tension is set optimally at the BERNINA factory and the machine has been tested. Metrosene-/Seralon thread size 100/2 (Company Mettler, Switzerland) is used for upper and bobbin thread.

When of using other types of sewing or embroidery threads, the optimal tension may vary. Therefore it may be necessary to adjust the upper thread tension according to the sewing or embroidering project as well as the desired stitch pattern or the embroidery motif individually.

The higher the upper thread tension, the tighter the upper thread which means that the bobbin thread is pulled up to the top of the fabric. When the upper thread tension is low, the upper thread is less tightened which means that the bobbin thread is pulled up less.

Alteration to the upper thread tension affect the currently selected stitch pattern or embroidery motif. Permanent alterations of the upper thread tension for the Sewing Mode (see page 51) and for the Embroidering Mode (see page 55) can be made in the Setup Program.

Prerequisite:

- The upper thread tension has been altered in the setup program.
- > Tap «Upper Thread Tension».



- > Adjust the upper thread tension.



- > Tap the yellow-outlined icon on the right side to reset the alterations to the default setting.
- > Tap the yellow-outlined icon on the left side to reset the alteration to default setting in the **Setup Program**.

5.5 Editing stitch patterns

Changing the stitch width

- > Turn the «Upper Multi-function knob» to the left to narrow the stitch width.
- > Turn the «Upper Multi-function knob» to the right to widen the stitch width.
- > To call up further setting options, tap the icon «Stitch width» (1).



Changing the stitch length

- > Turn the «Lower Multi-function knob» to the left to shorten the stitch length.
- > Turn the «Lower Multi-function knob» to the right to elongate the stitch length.
- > To call up other setting options, tap «Stitch length» (1).



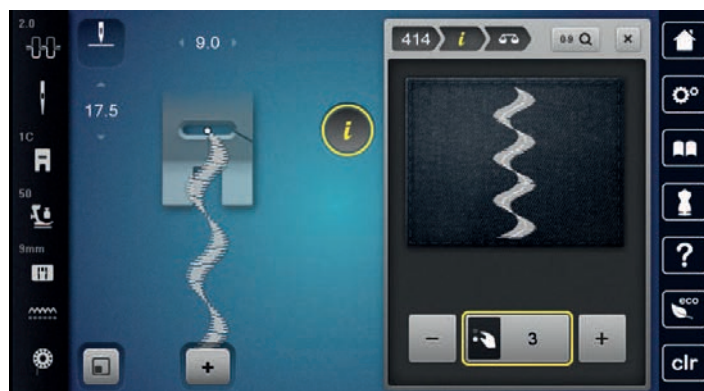
Correcting the balance

Different fabrics, threads and stabilizers can affect the programmed stitch patterns so that they cannot be sewn out correctly. The electronic balance can correct these deviation and the stitch pattern can be adjusted optimally to the selected fabric.

- > Select a stitch pattern or alphabet.
- > Sewing stitch pattern.
- > Tap «i-Dialog».



- > Tap «Balance».
- A preview of the stitch pattern is displayed.



- > To correct the longitudinal direction of the stitch pattern, turn the «Lower Multi-function knob» until the preview of the stitch pattern matches the stitch pattern sewn on the fabric.



- > Altered Balance settings can be saved for each stitch in the «Personal Memory» .
- > Altered Balance settings only remain valid until the «Clear Settings» is pushed or the machine is switched off.

Programming pattern repeat

Stitch patterns can be repeated up to 99 times.

- > Select a stitch pattern or alphabet.
- > Tap «i-Dialog».



- > Tap «Pattern Repeat».
- > Enter the required number of stitch patterns.



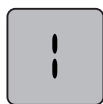
- > Tap «Confirm».

Programming long stitch

The maximum length for long stitches is 12 mm and the machine sews every second stitch.

- > Select a stitch pattern.
- > Tap «i-Dialog».





- > Tap «Long stitch».

Mirror image of stitch patterns



- > Select a stitch pattern or alphabet.
- > Tap «i-Dialog».



- > To mirror the stitch pattern from left to right, tap «Mirror Image Left/Right».



- > To mirror the stitch pattern contrary to the sewing direction, tap «Mirror Image Up/Down».

Editing stitch pattern length

The stitch patterns can be lengthwise extended or shortened.



- > Select a stitch pattern or alphabet.
- > Tap «i-Dialog».



- > Tap «Edit Stitch Pattern Length».
- > Adjust the stitch pattern length.

Programming the stitch counter function

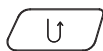
The Stitch Counter function cannot be applied with all stitch patterns. If, for example, the Honeycomb stitch No. 8 has been selected, the Stitch Counter function cannot be used.



- > Select a stitch pattern.
- > Tap «i-Dialog».
- > Lower the needle.



- > Tap «Programming the length via the Stitch Counter».
- > Sew the desired length.



- > Push the button «Quick Reverse».
 - The display changes to «Auto» and the selected stitch pattern in the new length is saved until the machine is switched off.

Sewing stitch patterns using the triple stitch

The stitch pattern can be sewn three times for a more attractive result. Not all stitch patterns can be sewn using the triple stitch.



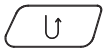
- > Select a stitch pattern.
- > Tap «i-Dialog».



> Tap «Triple Stitch».

Quick reverse

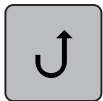
- > Select a stitch pattern or alphabet.
- > To switch immediately to sewing in reverse when pushing the button «Quick Reverse», select Needle Stop Down (permanent).
- > Program needle stop up (permanent) to sew another stitch forward before the machine switches to reverse sewing.



> Push and hold the button «Quick Reverse».

Permanent Quick reverse

- > Select a stitch pattern or alphabet.
- > Tap «i-Dialog».



- > To sew permanently in reverse, tap «Permanent Quick Reverse».
 - The machine sews permanently in reverse until the icon «Permanent Quick Reverse» is tapped again.

Backstepping

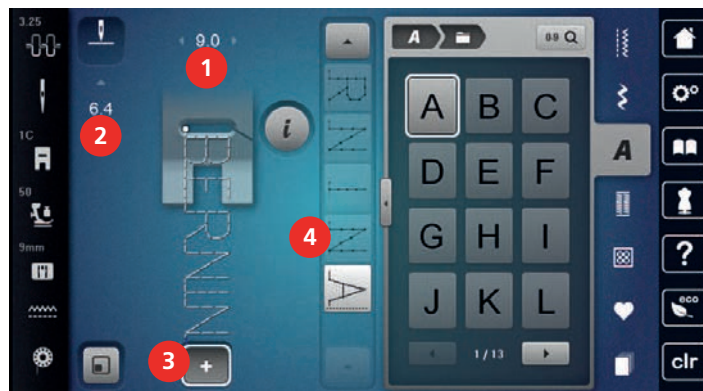
- > Select a stitch pattern or alphabet.
- > Tap «i-Dialog».



> To backstep the last 200 stitches, tap «Backstepping».

5.6 Combining stitch patterns

Overview Combi mode



1 «Stitch Width»


2 «Stitch length»

3 «Combination Mode/Single Mode»


4 Individual stitch pattern within the combination

Creating Stitch pattern combinations

In the Combi-mode stitch patterns and alphabets can be combined according to your wish. By combining any alphabet letters, the logo BERNINA can be created.

-  > Tap «Combination Mode/Single Mode».
- > Select the desired stitch patterns.



-  > To get back to the Single Mode, tap «Combination Mode/Single Mode» again.

Saving a stitch pattern combination

To use an individually created stitch pattern combinations again, they can be saved in the folder «Personal Memory».

- > Create a stitch pattern combination.
- > Tap «Personal Memory».




-  > Tap «Save stitch pattern».

-  > To save the stitch pattern combination, tap «Confirm».

Loading a stitch pattern combination

-  > Tap «Combination Mode/Single Mode».


-  > Tap «Personal Memory».


-  > Tap «Loading a stitch pattern combination».
- > Select a stitch pattern combination.

Overwriting a stitch pattern combination

- > Create a stitch pattern combination.
- > Tap «Personal Memory».



-  > Tap «Save stitch pattern».
- > Select the stitch pattern combination which is to be overwritten.

-  > To overwrite the stitch pattern combination, tap «Confirm».

Deleting a stitch pattern combination

- > Create a stitch pattern combination.
- > Tap «i-Dialog».
- > Tap «Edit Entire Combination».



- > Tap «Delete».



- > Tap «Confirm».

Editing a single stitch pattern

- > Create a stitch pattern combination.
- > To select a single stitch pattern, tap the desired position (1) within the stitch pattern combination.



- > To edit the single stitch pattern, tap «i-Dialog».

Deleting a single stitch pattern

Prerequisite:

- A stitch pattern combination has been created.
- > Tap the desired stitch pattern (1) within the stitch pattern combination.



- > Tap «i-Dialog».



- > Tap «Delete».

Adding a single stitch pattern

The new stitch pattern is always inserted **after** the selected stitch pattern.

- > Create a stitch pattern combination.
- > To select a single stitch pattern, tap the desired position (1) within the stitch pattern combination.



- > Select a new stitch pattern.

Adapting the stitch pattern length and stitch pattern width

The length and width of the individual stitch patterns in a stitch pattern combination can be adapted to the longest and widest stitch patterns in the combination.

- > Create a stitch pattern combination.
- > Tap «i-Dialog».

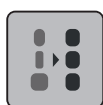


- > Tap «Edit Entire Combination».
- > Tap «Total Pattern Length» (1).



- > Tap «Adjust Length within Combination» (2).
 - The lengths of the stitch patterns are adapted to the length of the longest stitch pattern in the combination

- > Tap «Stitch Width» (3).



- > Tap «Adjust Width within Combination» (4).
 - The widths of all of the stitch patterns are adapted to the width of the widest stitch pattern in the combination

Furthermore, the length and width of the stitch pattern combination are increased or decreased proportionally.

- > To decrease the width of the stitch pattern combination proportionally, turn the «Upper Multi-function knob» anti-clockwise.
- > To increase the width of the stitch pattern combination proportionally, turn the «Upper Multi-function knob» clockwise.
- > To decrease the length of the stitch pattern combination proportionally, turn the «Lower Multi-function knob» anti-clockwise.
- > To increase the length of the stitch pattern combination proportionally, turn the «Lower Multi-function knob» clockwise.

Mirroring a stitch pattern combination



- > Create a stitch pattern combination.
- > Tap «i-Dialog».
- > Tap «Edit Entire Combination».

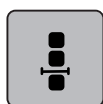


- > To mirror the whole stitch pattern combination from left to right, tap, «Mirror Image Left/Right».
- > To reset the changes and revert to the default settings, tap «Mirror Image Left/Right».

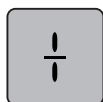
Stitch pattern combination Subdivider 1

A stitch pattern combination can be subdivided into several sections. The subdivision is placed **beneath** the cursor. Only this section is sewn where the cursor is placed. To sew the next section, the cursor must be placed in the next section.

- > Create a stitch pattern combination.
- > Select the desired position within the stitch pattern combination where the stitch pattern combination is to be subdivided.
- > Tap «i-Dialog».



- > Tap «Edit Combination at Cursor Position».

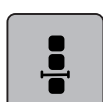


- > Tap «Combination Subdivider (1)».

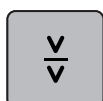
Stitch pattern combination Subdivider 2

A stitch pattern combination can be interrupted at various sections. The interruption is placed **beneath** the cursor.

- > Create a stitch pattern combination.
- > Select the desired position within the stitch pattern combination where the stitch pattern combination is to be interrupted.
- > Tap «i-Dialog».



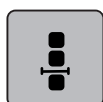
- > Tap «Edit Combination at Cursor Position».



- > Tap «Combination Subdivider (2)».
- > Sew the first section and then reposition the fabric.

Securing a stitch pattern combination

- > Create a stitch pattern combination.
- > Select the desired position within the stitch pattern combination where the stitch pattern combination is to be secured.
- > Tap «i-Dialog».



- > Tap «Edit Combination at Cursor Position».



- > Tap «Securing Stitches».
 - Every single pattern of the stitch pattern combination can be secured at the start or at the end.

Programming pattern repeat

- > Create a stitch pattern combination.
- > Tap «i-Dialog».



- > Tap «Edit Entire Combination».



- > To repeat the stitch pattern combination, tap «Pattern Repeat» 1x.
- > To repeat the stitch pattern combination up to 9x, tap «Pattern Repeat» again.
- > To deactivate the pattern repeat, tap and hold «Pattern Repeat» or tap «Clear Settings».

5.7 Administering stitch patterns

Saving settings of stitch patterns



- > Select a stitch pattern, alphabet or buttonhole.
- > Tap «i-Dialog».
- > Edit the stitch, alphabet or buttonhole.



- > To save all alterations permanently, tap «Save Stitch Pattern Settings».



- > To cancel all alterations, tap «Reset Stitch Pattern».

Calling up the previously sewn stitch patterns

The 15 previously sewn stitch patterns are saved automatically and can be called up at any time.



- > To display the previously sewn stitch patterns, tap «History».
- > Select a stitch pattern.

Saving stitch patterns in personal memory

In the folder «Personal Memory» any stitch patterns, also those which have been individually edited, can be saved.

- > Select a stitch pattern, alphabet or buttonhole.
- > Edit the stitch pattern.
- > Tap «Personal Memory».



- > Tap «Save stitch pattern».
- > Select the file where the pattern is to be saved.



- > Tap «Confirm».

Overwriting stitch patterns from the personal memory

Prerequisite:

- The stitch pattern is saved in the personal memory.
- > Select a stitch pattern, alphabet or buttonhole.
- > Edit the stitch pattern.
- > Tap «Personal Memory».

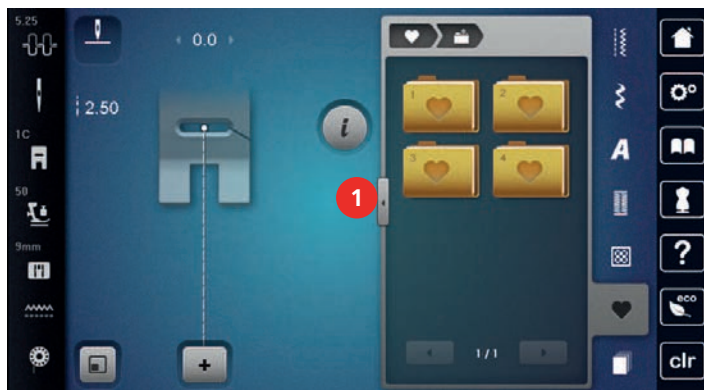


- > Tap «Save stitch pattern».
- > Select the file where the stitch pattern to be overwritten has been saved.
- > Select the stitch pattern which should be overwritten.



- > Tap «Confirm».

- > Tap «Increasing/Decreasing the display size» (1).



- > Insert the BERNINA USB stick into the USB port of the machine.
- > Tap «USB Stick».
- > Select the desired stitch pattern.

Deleting stitch patterns from the BERNINA USB stick



- > Tap «Personal Memory».



- > Tap «Delete».
- > Insert the BERNINA USB stick into the USB port of the machine.
- > Select the stitch pattern which is to be deleted.



- > Tap «Confirm».

5.8 Securing

Securing with the button «Pattern end»

The «Pattern End» button can be programmed with various securing stitches.



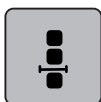
- > Push the button «Pattern End» before sewing is started or while sewing.
 - While sewing, a stop icon indicates that the function is activated and the stitch pattern or the current combination of a stitch pattern will be secured at the end with the programmed number of stitches.

Securing via the icon «Securing»

Every single pattern of the stitch pattern combination can be secured at the start or at the end.



- > Tap «i-Dialog».



- > Tap «Edit Combination at Cursor Position».



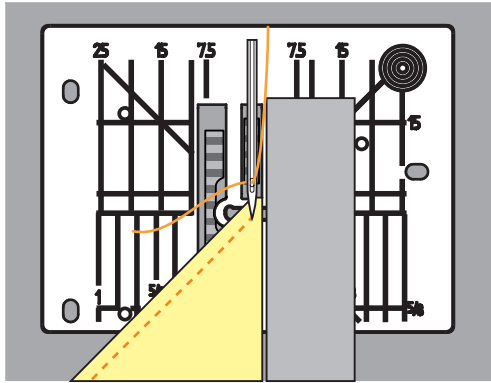
- > Tap «Securing Stitches» before sewing is started.
 - The stitch pattern/stitch pattern combination is secured with 4 stitches at the beginning.
- > Tap «Securing Stitches» while sewing.
 - The stitch pattern or the active stitch pattern of the stitch pattern combination is secured with 4 stitches at the end.



5.10 Sewing Corners

When sewing corners, only a small section of the fabric is actually on the feed dog. Therefore it cannot grip the fabric well. By means of the height compensation tool the fabric can be fed evenly.

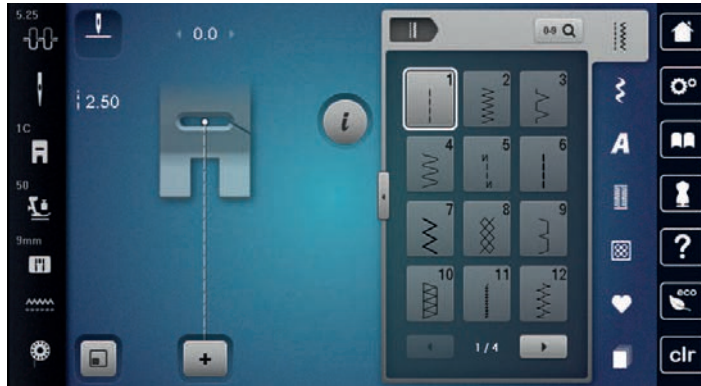
- > When the fabric edge is reached, stop the sewing process with needle position down.
- > Raise the presser foot.
- > Turn the fabric and place in desired position.
- > Place 1 – 3 compensating plates as required on the right of the presser foot close to the sewing project.
- > Lower the presser foot.



























- > Resume sewing until the sewing project is on the feed dog again.

6 Practical stitches















6.1 Overview Practical Stitches



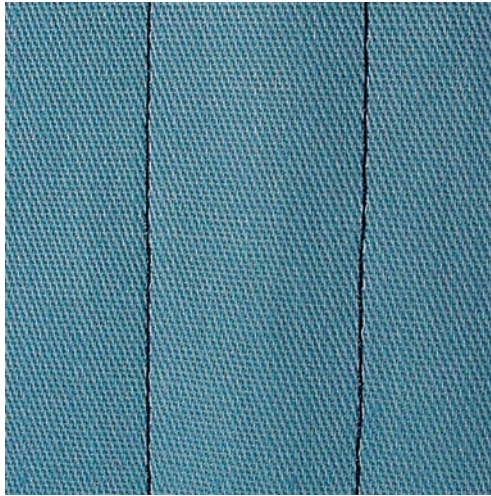
Stitch patterns	Stitch number	Name	Description
	1	Straight stitch	To join seams, for topstitching and basting.
	2	Zigzag	To finish edges, to sew elastic seams, to sew on lace inserts and elastics.
	3	Vari-overlock	For finishing edges, sewing together and simultaneously finishing elastic fabrics.
	4	Running stitch	For darning and reinforcing fabric edges or attaching lace or rubber tape.
	5	Securing program	For automatic securing at the start of the seam with forward and reverse stitches.
	6	Triple straight stitch	For reinforced seams on heavy fabrics and decorative effects.
	7	Triple zigzag	For durable seams on strong fabrics, visible hems and decorative seams.
	8	Honeycomb stitch	For stretch fabrics and hems, including with rubber threads.
	9	Blind stitch	For blind hems on most fabric types and for shell edging on soft jerseys and fine fabric.
	10	Double overlock	For simultaneously sewing together and finishing elastic fabrics.

	11	Super stretch stitch	For highly stretch open seams.
	12	Gathering stitch	For gathering with rubber threads and for flat joining seams on medium-weight fabrics.
	13	Stretch overlock	For simultaneously sewing together and finishing elastic fabrics, as well as for flat joining seams.
	14	Tricot stitch	For visible hems and seams in lingerie and sweaters and for mending tricot fabric.
	15	Universal stitch	For flat joining seams, visible hems and decorative seams in strong fabrics such as felt and leather and for attaching rubber tape.
	16	Sewn-out zigzag	For finishing and reinforcing fabric edges, for sewing on rubber tape and for decorative seams.
	17	Lycra stitch	For flat joining seams, visible hems on Lycra fabric and for stitching over seams in foundation garments.
	18	Stretch stitch	For stretchable seams and hems in woven and knitted fabrics.
	19	Reinforced overlock	For overlock seams or flat joining seams on medium-weight knit fabrics and toweling.
	20	Knit overlock	For stretchable seams and hems in woven and knitted fabric, for sewing and finishing.
	21	Basting stitch	For tacking seams and hems and for quilting projects.
	22	Simple darning program	For automatic darning in fine to strong fabrics.
	23	Reinforced darning program	For automatic darning in strong materials.
	24	Bartack program	For reinforcing pocket openings, buttonhole bars and for sewing belt loops.



	25	Bartack program	For reinforcing pocket openings, sewing belt loops and securing seam ends.
	26	Large fly stitch	For reinforcing pocket openings, zippers and slits in medium-weight to thick fabrics.
	27	Small fly stitch	For reinforcing pocket openings, zippers and slits in fine to medium-weight fabrics.
	29	Narrow blind stitch	For blind hems and shell edging in light, fine and soft fabrics.
	31	Triple straight stitch with long stitch	For durable seams in strong fabrics, e.g. visible and decorative seams.
	32	Single straight stitch	As a connecting stitch in a combination for one straight stitch.
	33	Three single straight stitches	As connecting stitches in a combination for three individual straight stitches.
	34	Darning stitch	For darning together with the function "Permanent reverse sewing".
	35	Open overlock stitch	For simultaneously sewing together and finishing elastic fabrics with a reinforced edge.
	36	Overlock	For medium-weight knitted goods.
	37	Reinforced overlock stitch	For simultaneously sewing together, finishing and reinforcing elastic fabrics.
	38	Chain stitch	For decorative and reinforcing stitches on most woven fabrics.
	39	Cover stitch effect	To sew decorative seams and hems in heavy knitted goods and woven fabrics.
	40	Cover stitch effect	To sew decorative seams and hems in heavy knitted goods and woven fabrics.

6.2 Sewing straight stitch



Match the stitch length with the sewing project, such as for denim fabrics use long stitches (ca. 3 – 4 mm), for delicate fabrics use short stitches (ca. 2 – 2.5 mm). Match the stitch length with the thread size, e. g. when edgestitching with Cordonnet, use long stitches (ca. 3 – 5 mm).

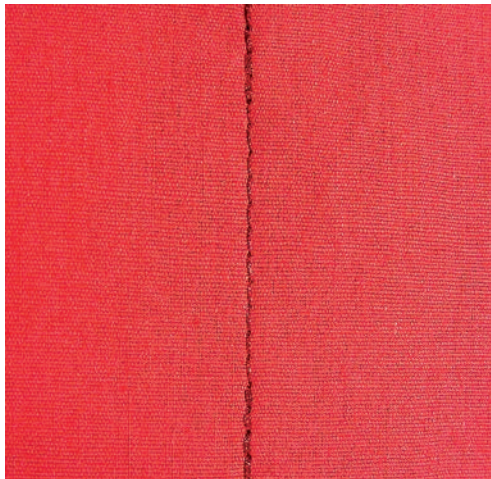
Prerequisite:

- The Reverse Pattern Foot #1C/1D is fitted.



- > Tap «Practical Stitches».
- > Select Straight stitch No. 1.

6.3 Securing with the automatic Securing Program



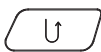
Due to a determined number of 6 stitches sewn forward and 6 stitches sewn backward, the securing is regular.

Prerequisite:

- The Reverse Pattern Foot #1C is fitted.

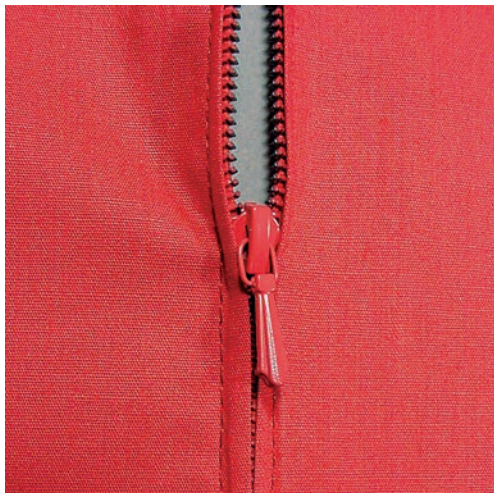


- > Tap «Practical Stitches».
- > Select Securing program No. 5.
- > Press the foot control.
 - The machine secures automatically.



- > Sew the required length of seam.
- > Push the button «Quick Reverse».
 - The machine secures automatically and stops at the end of the securing program.

6.4 Sewing in the zipper

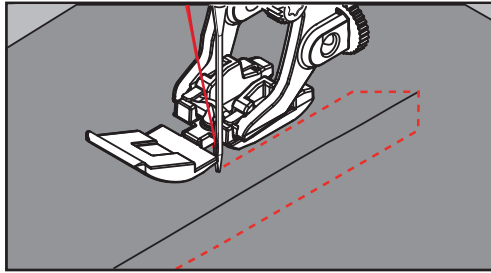


As the fabric feed can be difficult when starting to sew, it is recommended to hold the threads firmly or to pull the fabric slightly to the back for a few stitches or to sew 1 – 2 cm reverse first.



- > Fit the Reverse Pattern Foot #1C.
- > Tap «Practical Stitches».
- > Select Straight stitch No. 1.
- > Sew the seam up to where the zipper starts.
- > Sew the securing stitches.
- > Close the zipper length with long stitches.
- > Finish the seam allowances.
- > Iron the seam.
- > Open the zipper length.
- > Baste the zipper under the fabric so that the fabric folded edges meet over the center of the zipper.
- > Open the zipper a few centimeters.
- > Fit the Zipper Foot #4D.
- > Move the needle position to the right.
- > Use the Free Hand System to raise the presser foot and to position the sewing project.
- > Start sewing from top left.
- > Guide the foot so that the needle stitches along the zipper coils.
- > Stop in front of the zipper pull with needle position down.
- > Raise the presser foot.
- > Close the zipper.
- > Continue to sew and stop in front of the base of the zipper with needle position down.
- > Raise the presser foot and turn the sewing project.
- > Sew across the other side of the zipper and stop with needle position down.
- > Raise the presser foot and turn the sewing project.

- > Sew the second side from bottom to top.



6.5 Sewing both sides of the zipper from bottom to top

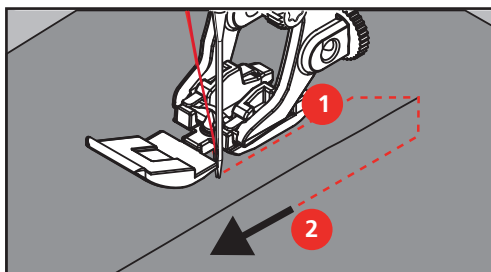
For fabrics with pile, such as velvet, it is recommended to sew in the zipper on both sides from bottom to top.



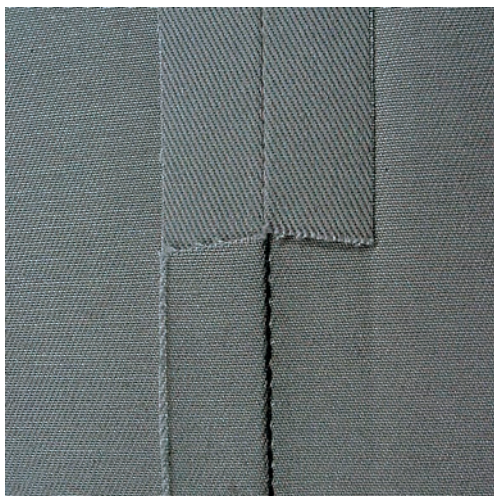
When the fabric is densely woven or hard, it is recommended to use a needle with the size 90 – 100. This results in an even stitch formation.



- > Fit the Reverse Pattern Foot #1C.
- > Tap «Practical Stitches».
- > Select Straight stitch No. 1.
- > Sew the seam up to where the zipper starts.
- > Sew the securing stitches.
- > Close the zipper length with long stitches.
- > Finish the seam allowances.
- > Iron the seam.
- > Open the zipper length.
- > Baste the zipper under the fabric so that the fabric folded edges meet over the center of the zipper.
- > Fit the Zipper Foot #4D.
- > Move the needle position to the right.
- > Use the Free Hand System to raise the presser foot and to position the sewing project.
- > Start sewing in the center of the seam at the end of the zipper.
- > Sew diagonally along the edge of the zipper coils.
- > Sew the first side (1) from bottom to top.
- > Stop in front of the zipper pull with needle position down.
- > Raise the presser foot.
- > Open the zipper as far as behind the presser foot.
- > Lower the presser foot and continue sewing.
- > Move the needle position to the left.
- > Sew the second side (2) in exactly the same way from bottom to top.



6.6 Sewing Triple straight stitch

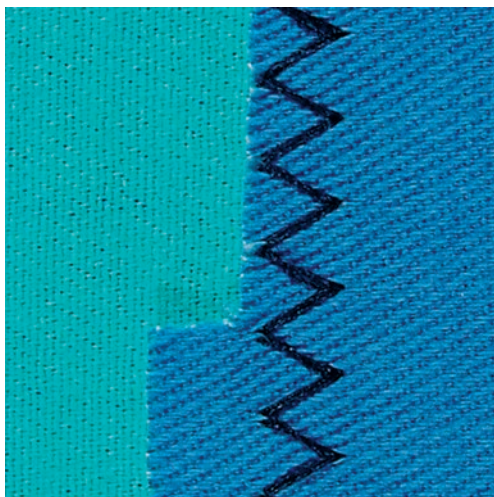


The Triple straight stitch is especially suitable for durable seams and for firm, densely woven fabrics such as denim and corduroy. For firm or densely woven materials it is recommended to fit the Jeans Foot #8. This facilitates sewing denim or canvas. For decorative topstitching the stitch length can be elongated.

- > Fit the Reverse Pattern Foot #1C/1D.
- > Tap «Practical Stitches».
- > Select Triple straight stitch No. 6.



6.7 Sewing Triple Zigzag

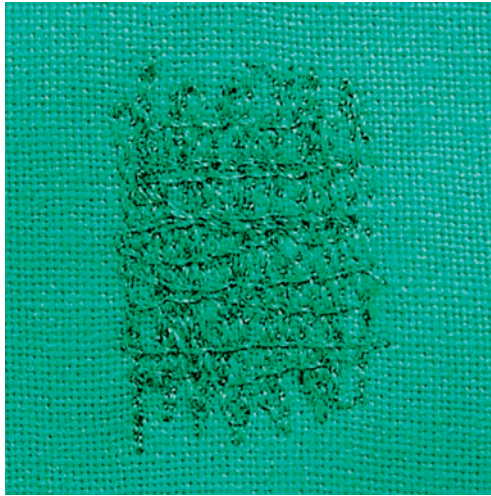


For firm materials such as denim, deckchair covers, awnings or frequently washed items. Finish raw edges first.

- > Fit the Reverse Pattern Foot #1C/1D.
- > Tap «Practical Stitches».
- > Select Triple zigzag No. 7.



6.8 Manual darning

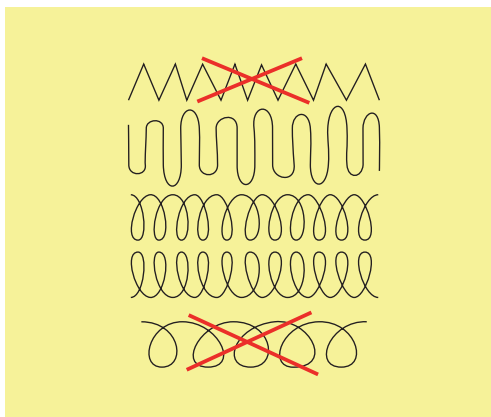


Used for darning holes or worn areas in all fabric types.

If the thread is lying on top and a poor stitch formation results, slow down the movement of the sewing project. If there are knots on the wrong side of the fabric, move the sewing project faster. When the thread breaks, guide the sewing project more consistently.



- > Fit the Darning Foot #9.
- > Tap «Practical Stitches».
- > Select Straight stitch No. 1.
- > Lower the feed dog.
- > Attach the Slide-on Freearm Extension Table.
- > Hoop the sewing project in the round embroidery hoop (optional accessory).
 - The darning area stays evenly taut and cannot be distorted.
- > Sew from the left to the right, guide the fabric evenly by hand without using pressure.
- > Move in curves when changing the direction to avoid holes and thread breakage.
- > Work the edges in irregular lengths so that the thread is better spread over the fabric.



- > Sew the first rows not too close together and beyond the worn area.

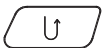
6.9 Automatic darning



Simple darning program No. 22 is particularly suitable for quick darning of worn areas or tears. It is recommended to use fine material as a backing for the worn and damaged areas or to stick on an adhesive interlining. The Simple darning program No. 22 replaces the longitudinal threads in all fabrics. If the fabric becomes distorted, correct with the Balance.

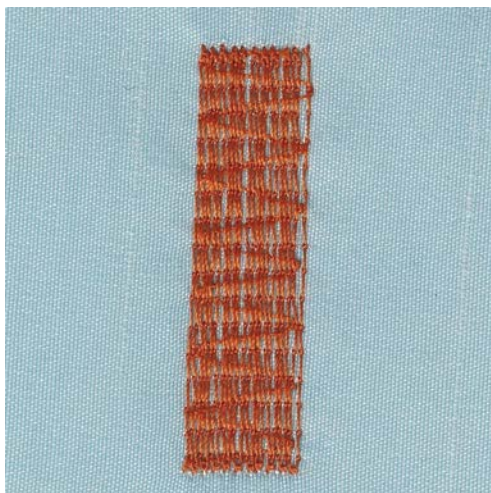


- > Fit the Reverse Pattern Foot #1C or Buttonhole foot with slide #3A.
- > Tap «Practical Stitches».
- > Select Simple darning program No. 22.
- > Hoop light-weight materials in the round embroidery hoop (optional accessory).
 - The darning area stays evenly taut and cannot be distorted.
- > Start sewing top left.
- > Sew the first row.
- > Stop the machine.



- > Push the button «Quick Reverse».
 - The length is programmed.
- > Finish sewing the Darning Program.
 - The machine stops automatically.

6.10 Reinforced darning, automatic



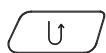
The Reinforced darning program No. 23 is particularly suitable for quick darning of worn areas or tears. The Reinforced darning program No. 23 replaces the longitudinal threads in all fabrics.



If the Darning Program does not cover the whole worn or damaged area, it is recommended to reposition the work and sew the Darning Program again. The length is programmed and can be repeated as often as desired.



- > Fit the Buttonhole foot with slide #3A.
- > Tap «Practical Stitches».
- > Select Reinforced darning program No. 23.
- > Hoop light-weight materials in the round embroidery hoop (optional accessory).
 - The darning area stays evenly taut and cannot be distorted.
- > Start sewing top left.
- > Sew the first row.
- > Stop the machine.



- > Push the button «Quick Reverse».
 - The darning length is programmed.
- > Finish sewing the Darning Program.
 - The machine stops automatically.

6.11 Finishing edges



Zigzag No. 2 is suitable for all materials. It can also be used for elastic seams as well as for decorative sewing. Use darning thread for fine materials. When sewing satin stitch (beads), it is recommended to select a dense, short the zigzag with a stitch length of 0.3 – 0,7 mm. The satin stitch can be used for appliqué and for embroidering.

Prerequisite:

- The edge of the fabric should lie flat and not roll.



- > Fit the Reverse Pattern Foot #1C.
- > Tap «Practical Stitches».
- > Select Zigzag No. 2 or Satin stitch No. 1315.
- > Neither select too wide a stitch nor too long a stitch.
- > Guide the edge of the fabric into the center of the presser foot, so that the needle goes into the fabric on one side and over the edge into the air on the other side.

6.12 Sewing Double overlock



A double overlock seam is suitable for loose knits and cross seams in knits. When working with jersey, a jersey needle should be used to prevent damaging the knit fabric. When sewing stretch materials, use a stretch needle.

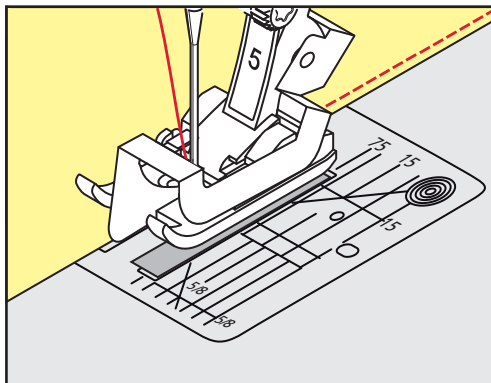


- > Fit the Reverse Pattern Foot #1C or Overlock Foot #2A.
- > Tap «Practical Stitches».
- > Select Double overlock No. 10.

6.13 Narrow edgestitching



- > Fit the Blindstitch Foot #5 or Edgestitch Foot #10/10C/10D.
- > Tap «Practical Stitches».
- > Select Straight stitch No. 1.
- > Place the left-hand edge against the guide of the Blindstitch foot.
- > Select the left-hand needle position at the desired distance to the edge.



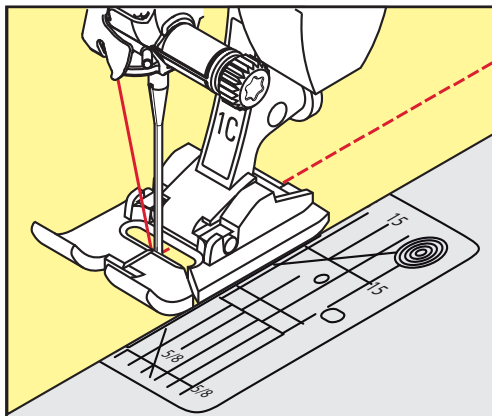
6.14 Wide edgestitching



- > Fit the Reverse Pattern Foot #1C.
- > Tap «Practical Stitches».
- > Select Straight stitch No. 1.
- > Guide the edge along the presser foot or at a distance of 1–2.5 cm along the marks on the stitch plate.



- > Select the needle position at the desired distance to the edge.

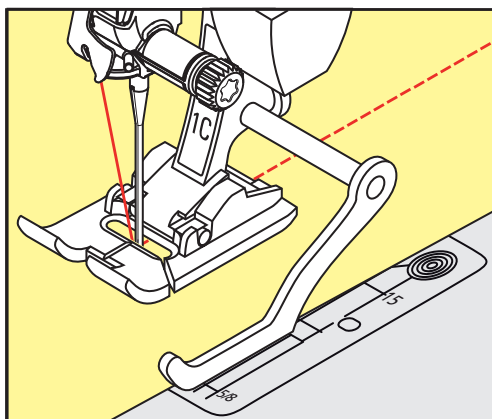


6.15 Edgestitching using the seam guide

When sewing parallel wider lines, it is recommended to guide the seam guide along the sewn of lines.



- > Fit the Reverse Pattern Foot #1C.
- > Tap «Practical Stitches».
- > Select Straight stitch No. 1.
- > Loosen the screw on the back of the presser foot.
- > Insert the seam guide into the hole in the presser foot.
- > Adjust the width as required.
- > Tighten the screw.
- > Guide the folded edge along the seam guide.



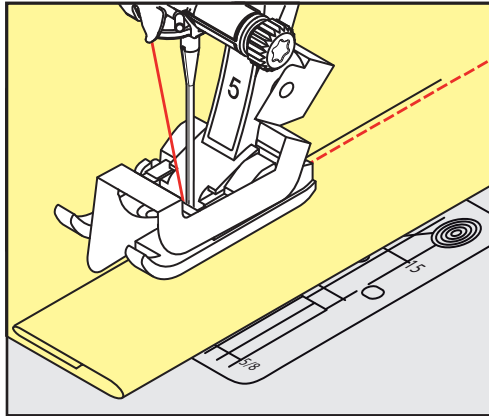
6.16 Sewing hem edges

When using the Blindstitch Foot #5, it is recommended to set the needle position far left or far right. With the Reverse Pattern Foot #1C and the Edgestitch Foot #10/10C/10D, all needle positions are possible.

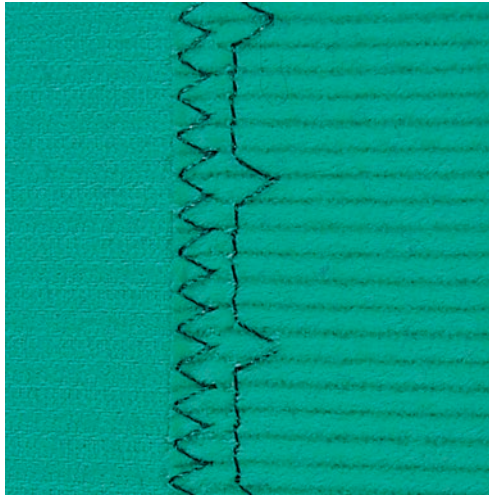


- > Fit the Blindstitch Foot #5 or the Reverse Pattern Foot #1C or the Edgestitch Foot #10/10C/10D.
- > Tap «Practical Stitches».
- > Select Straight stitch No. 1.
- > Place the inside upper edge right against the guide for the Blindstitch foot.

- > Select the needle position to the far right in order to sew along the upper edge.



6.17 Sewing blind hems



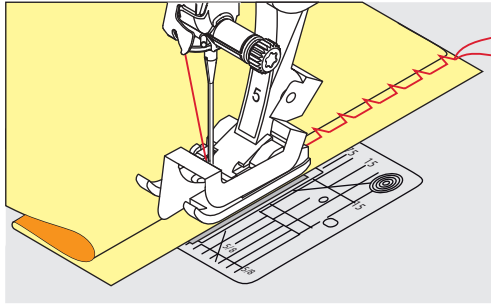
For invisible hems in medium to heavy weight cotton, wool and blended materials.

Prerequisite:

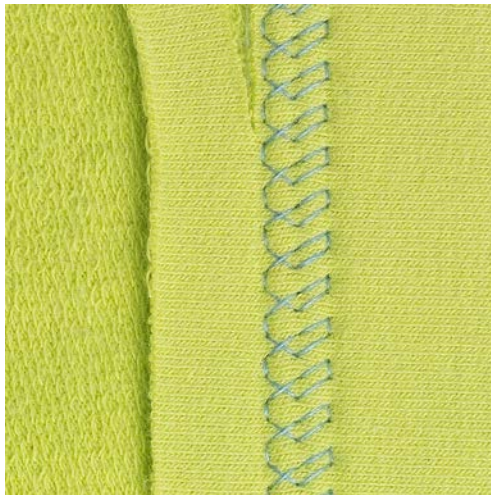
- The fabric edges are finished.
- > Fit the Blindstitch Foot #5.
- > Tap «Practical Stitches».
- > Select Blind stitch No. 9.
- > Fold the fabric back over the right side of the fabric to expose the overcast edge.
- > Place the fabric under the presser foot and move the folded edge against the metal guide on the presser foot.
- > Guide the folded edge evenly along the metal guide of the presser foot to sew the stitches evenly deep.
 - Make sure that the needle only pierces the edge of the fold.



- > After sewing about 10 cm, check both sides of the fabric and adjust the width again if necessary.



6.18 Sewing visible hems

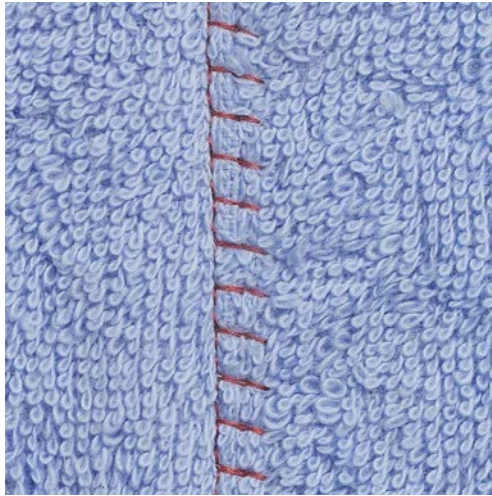


The visible hem is particularly suitable for elastic seams in tricot made of cotton, wool, synthetic and mixed fibers.



- > Fit the Reverse Pattern Foot #1C/1D.
- > Tap «Practical Stitches».
- > Select Tricot stitch No. 14.
- > Iron the hem and baste if necessary.
- > Reduce the Presser Foot Pressure if necessary.
- > Sew the hem in the desired depth on the right side.
- > Trim off the remaining fabric on the reverse side.

6.19 Sewing flat joining seams

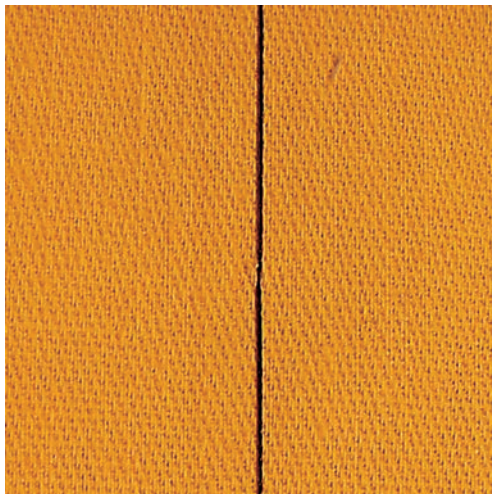


The flat joining seam is especially suitable for long-pile or thick materials such as terry cloth, felt or leather.



- > Fit the Reverse Pattern Foot #1C.
- > Tap «Practical Stitches».
- > Select Stretch overlock No. 13.
- > Overlap the fabric edges.
- > Sew along the fabric edge.
- > To get a very flat, durable seam, make sure the needle stitches right over the top edge of the fabric into the bottom fabric.

6.20 Sewing basting stitches



When sewing basting stitches, it is recommended to use a fine darning thread. This is easier to remove. With the Basting stitch No. 21 only every fourth stitch is sewn. The longest stitch possible is 24 mm with a selected stitch length of 6 mm. The recommended stitch length is 3.5 – 5 mm. The basting stitch is suitable for sewing projects where a very long stitch length is desired.



- > Fit the Reverse Pattern Foot #1C/1D.
- > Tap «Practical Stitches».
- > Select Basting stitch No. 21.
- > Select the stitch length.
- > Pin the fabric layers at a right angle to basting direction to prevent the layers from slipping.
- > Sew 3 – 4 securing stitches at the start and at the end.

7 Decorative stitches


7.1 Overview Decorative Stitches

Easier or more difficult decorative stitches come into their own depending on the type of fabric.

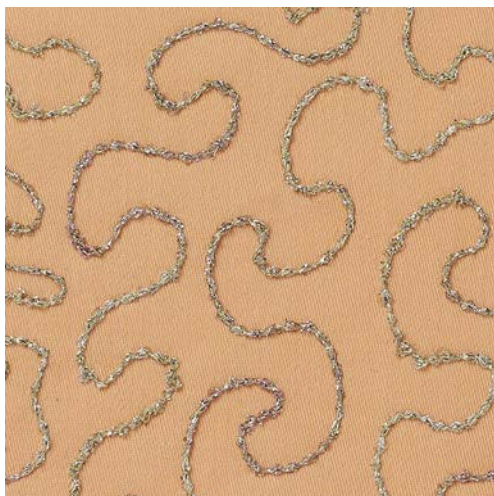
- Decorative stitches which are programmed with simple straight stitches are particularly appropriate for lightweight materials, e. g. Decorative stitchNo. 101.
- Decorative stitches which are programmed with triple straight stitches or with a few satin stitches are particularly appropriate for medium-weight materials, e. g. Decorative stitchNo. 107.
- Decorative stitches which are programmed with satin stitches are particularly appropriate for heavyweight materials, e. g. Decorative stitch No. 401.

For a perfect stitch formation it is of advantage to use the same thread color for upper and bobbin thread and a stabilizer. With pile or long-pile materials it is recommended to use an additional, water-soluble stabilizer on the right side which can be easily removed after sewing.



Decorative stitch	Category	Name
	Category 100	Natural stitches
	Category 300	Cross stitches
	Category 400	Satin stitches
	Category 600	Geometric stitches
	Category 700	Heirloom stitches
	Category 900	Novelty stitches
	Category 1700	International
	Category 2000	Seasons
	Category 2200	Hobbies and sport

7.2 Bobbin-Play



The bobbin can be filled with different thread material. For free-motion stitching to add texture. This method is similar to «normal» free-motion sewing, but is done on the **wrong** side of the fabric.

Reinforce the area to be sewn with embroidery stabilizer. The design can be drawn on the wrong side of the fabric. You can also draw the design on the front side of the fabric. The lines can be followed with a freely guided straight stitch using polyester, cotton or rayon thread. The rows of stitching are visible on the right side of the fabric, and serve as reference lines for the bobbin-thread sewing.

The BSR function can be used for bobbin-thread sewing. It is recommended to guide your project at consistent speed evenly under the needle, following the lines of the design. The stabilizer must be removed after sewing.

Sew a sample first to check what the result looks like on the wrong side of the fabric.

Not all decorative stitches are suitable for this technique. Simple decorative stitches provide best results. Avoid compact stitch types and satin stitches.

NOTICE

Inappropriate bobbin case is used

Damage of the bobbin case.

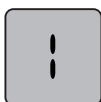
> Use the special bobbinwork case (optional accessory).



- > Fit the Open Embroidery Foot #20C/20D.
- > Tap «Decorative Stitches».
- > Select the appropriate decorative stitch.
- > Turn the «Upper Multi-function knob» and «Lower Multi-function knob» to set the stitch length and stitch width, so that a beautiful stitch formation can be achieved even when sewing with thick thread.



> Tap «i-Dialog».



- > Tap «Long stitch».
- The stitch pattern is sewn less densely



> To adjust the upper thread tension, tap «Upper Thread Tension».

7.3 Altering the stitch density

With certain decorative stitches (e. g. No. 401) the stitch density can be altered. If the stitch density is increased, the stitch distance is enlarged. If the stitch density is decreased, the stitch distance is shortened. The programmed length of the stitch pattern is not affected.

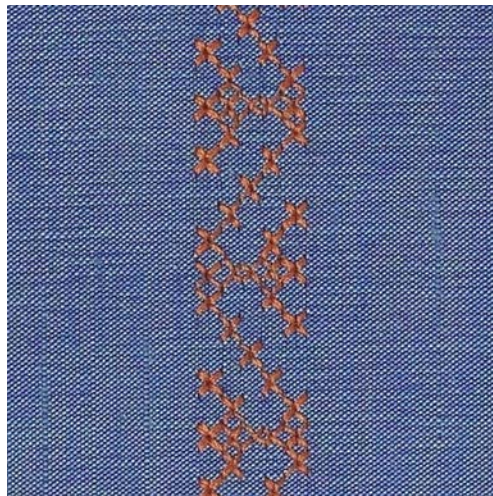
- > Select the decorative stitch.
- > Tap «i-Dialog».



- > Tap «Altering the Pattern Length/Stitch Density».
- > Set the stitch density (1).



7.4 Sewing cross stitches



Cross stitching is a traditional technique, and extends the range of decorative stitches. If the cross stitches are sewn on fabric with a linen texture, they look like hand-stitched cross stitching. When cross stitches are sewn with cotton embroidery thread, the stitch pattern appears fuller. Cross stitches are particularly used for home furnishing, trimmings on garments and embellishing in general. As every following line refers to the first row, it is important to stitch the first row in a straight line.

- > Fit the Reverse Pattern Foot #1C/1D or Open Embroidery Foot #20C/20D.
- > Select a cross stitch of the Category 300 and combine it as desired.
- > Stitch the first row using the seam guide to sew a straight line.
- > Stitch the second row next to the first at a distance of one presser foot's width or using the seam guide.



7.5 Pintucks

Pintucks



Pintucks are narrow stitched folds which are normally sewn on the fabric before cutting out the pieces for garments or other sewing projects. They are suitable for embellishing or in combination with other heirloom embroidery techniques. The use of Pintuck Feet can simplify this technique considerably. This technique reduces the size of the fabric. This means that always enough fabric should be calculated.

Overview Pintuck Feet

Pintuck foot	Number	Description
	# 30 (optional accessory)	3 grooves For heavy-weight fabrics. In combination with the 4 mm double needle
	# 31 (optional accessory)	5 grooves For heavy to medium-weight fabrics. In combination with the 3 mm double needle

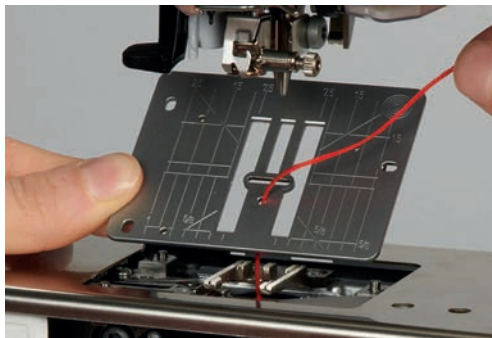
Pintuck foot	Number	Description
	# 32 (optional accessory)	7 grooves For light to medium-weight fabrics. In combination with the 2 mm double needle
	# 33 (optional accessory)	9 grooves For very light fabrics (without extra cord). In combination with the 1 or 1.6 mm twin needle
	# 46C (optional accessory)	5 grooves In combination with the 1.6 – 2.5 mm double needle For very light to medium-weight fabrics.

Working with cord

A more distinctive and relief-like effect can be achieved when the pintucks are corded, which means that they are sewn with an additional pintuck cord. Chose a pintuck cord that fits well into the grooves of the selected pintuck foot. The cord must be colorfast and shrinkproof.

- > Switch off the machine and disconnect it from the power supply.
- > Remove the needle.
- > Remove the presser foot.
- > Remove the stitch plate.
- > Open the hook cover.
- > Pull the cord through the hook opening from the bottom and through the opening of the stitch plate.
- > Replace the stitch plate.
- > Close the Loper cover.

- > Make sure that the cord slides through the thread slot of the bobbin cover.



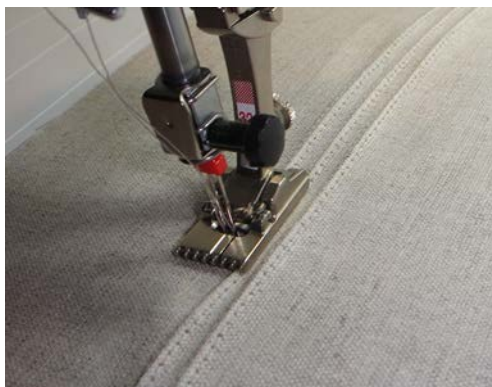
- > Place the spool on the spool holder.



- > Check that the cord runs smoothly.
- > If the thread doesn't glide smoothly at the hook cover, leave the hook cover open.
- > If the hook cover is opened, deactivate the lower thread indicator in the Setup Program.
 - The cord lies on the wrong side of the material and is hold/sewn over by the bobbin thread.

Sewing Pintucks

- > Insert the corresponding twin needle.
- > Threading the double needle.
- > Thread-up command.
- > Sewing the first pintuck.
- > Place the first pintuck in one of the side grooves in the presser foot.
- > Sew additional pintucks parallel.



8 Alphabets

8.1 Overview Alphabet

Block- outline, script, quilt and comic writing, as well as Cyrillic and Cyrillic script can be sewn in two different sizes. Block- outline, script, quilt and comic writing, as well as Cyrillic and Cyrillic script can also be sewn in small letters.

For a perfect stitch formation, it is recommended to use the same thread color for upper and bobbin threads. The fabric can be reinforced with embroidery stabilizer on the wrong side. When working with pile or napped fabrics, e.g. toweling, use an additional, water-soluble stabilizer on the right side of the fabric.



Stitch pattern	Name
ABCabc	Block alphabet
ABCabc	Double-Block
<i>ABCabc</i>	Script (Italics)
ABCabc	Quilting text
ABCabc	Comic writing
АБВабв	Cyrillic
<i>АБВ абв</i>	Cyrillic script
あいう	Hiragana
アイウ	Katakana

8.2 Creating lettering



It is recommend to sew a test sample using the desired thread, the original fabric and the original stabilizer. Please make sure that the fabric is fed evenly and lightly without colloding and being caught. Do not pull, push or hold the fabric while sewing.



- > Tap «Alphabets».
- > Select the font.



- > To create a combination, tap «Combination Mode/Single Mode».
- > To open the extended Enter Mode, tap «Increasing/Decreasing the display size» (1).



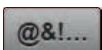
- > Select the letter.
- > To use upper-case letters, tap «Upper Case Characters» (standard setting).



- > To use lower-case letters, tap «Lower Case Characters».



- > To use figures and mathematical symbols, tap «Numbers and Mathematical Characters».



- > To use special characters, tap «Special Characters».



- > To delete individual syllables of the entered text, tap «Delete».
- > To close the extended Enter Mode, tap «Increasing/Decreasing the display size» again.

8.3 Altering font size

Block, Double block, Script and Comic alphabets as well as Cyrillic can also be downsized.



- > Tap «Alphabets».
- > Select the font.
- > Select the letter.



- > Tap «i-Dialog».



- > To reduce the font size, tap «Alter Font Size».
- > To scale up the font size to 9 mm, tap «Alter Font Size» again.












9 Buttonholes

9.1 Overview Buttonholes

To create the correct buttonhole for every button, every purpose and for every garment, your BERNINA 770 QE PLUS provides a considerable collection of buttonholes. The corresponding button can be sewn on automatically. Eyelets can also be sewn.



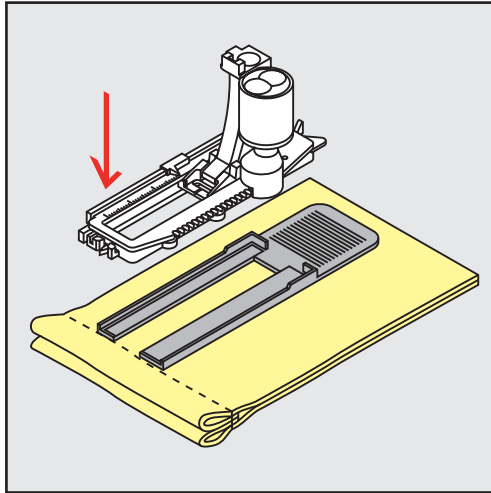
Stitch patterns	Stitch number	Name	Description
	51	Standard buttonhole	For light to medium-weight fabrics. e.g. blouses, dresses and bed linen.
	52	Narrow standard buttonhole	For light to medium-weight fabrics, e.g. blouses, dresses, children's and baby clothes, crafts.
	53	Stretch buttonhole	For all elastic fabrics.
	54	Round buttonhole with normal bartack	For medium-weight to heavy fabrics. e.g. dresses, jackets, coats and rainwear.
	55	Round buttonhole with horizontal bartack	For medium-weight to heavy fabrics, with a reinforced bar, e.g. dresses, jackets, coats and rainwear.
	56	Keyhole buttonhole	For heavy, non-stretch fabrics, e.g. jackets, coats and leisurewear.
	57	Keyhole buttonhole with pointed bartack	For stronger, non-stretch fabrics, e.g. jackets, coats, jeans and leisurewear.
	58	Keyhole buttonhole with horizontal bartack	For strong, non-stretch fabrics, e.g. jackets, coats and leisurewear.

	59	Straight stitch buttonhole	For staystitching and reinforcing buttonholes and as button hole edging, especially for buttonholes in leather and imitation leather.
	60	Button sew-on program	Sews buttons with 2 or 4 holes.
	61	Eyelet with small zigzag	Openings for cords or narrow ribbons and for decorative work.
	62	Eyelet with straight stitch	Openings for cords or narrow ribbons and for decorative work.
	63	Heirloom buttonhole	For handlook stitching effects on clothes and handicrafts on light to medium-weight fabrics.
	64	Double-rounded buttonhole	For medium-weight to heavy fabrics made from different fabrics.
	65	Double-rounded heirloom buttonhole	For light to medium-weight woven fabrics, e.g. blouses, dresses and bedlinen.
	67	Round buttonhole with bartack	For medium-weight woven fabrics, e.g. blouses, dresses and jackets.
	68	Decorative keyhole buttonhole with horizontal bartack	For stronger, non-stretch fabrics, e.g. jackets, coats and leisurewear.
	69	Decorative buttonhole with double pointed bartack	For decorative buttonholes in firmer, non-elastic fabrics.
	70	Decorative stretch buttonhole	For decorative buttonholes in light to medium-weight knitted fabrics.

9.2 Making use of the height compensation tool

When a buttonhole is to be sewn at right angles to the project edge, it is recommended to use the height compensation plates (optional accessory).

- > Place the plates from the back between the sewing project and the bottom of the slide to the thick part of the sewing project.

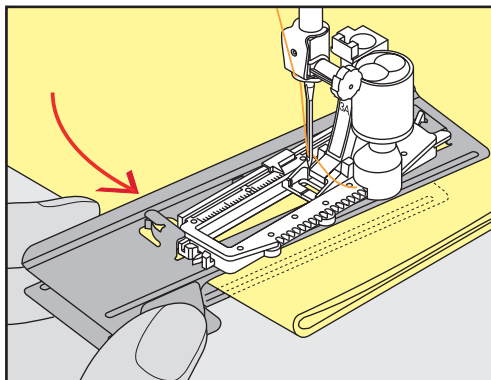


- > Lower the presser foot.

9.3 Using the compensation plate

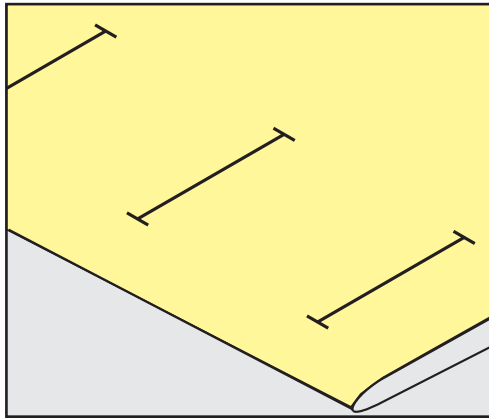
When sewing a buttonhole in difficult materials, it is recommended to use the Height Compensation Plate (optional accessory). It can be used in combination with the Buttonhole foot with slide #3A.

- > Insert the compensation plate carefully from the side.

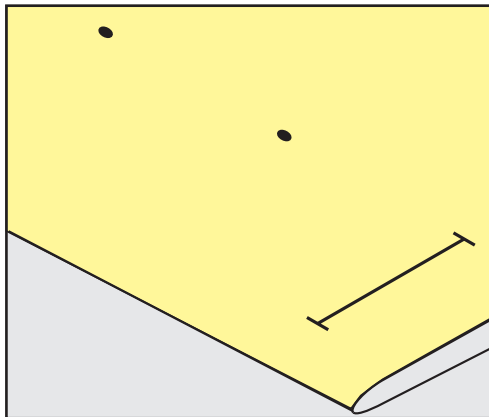


9.4 Marking buttonholes

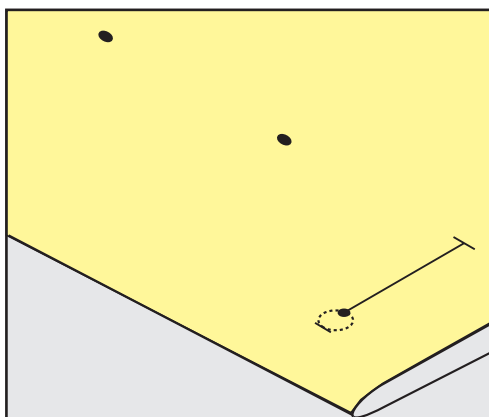
- > For the buttonholes to be sewn manually, mark the position and the length on the fabric using chalk or a water-soluble pen.



- > For the buttonholes to be sewn automatically, mark the complete length of 1 buttonhole on the fabric using chalk or a water-soluble pen. For any subsequent buttonholes mark the starting point.



- > For keyhole and round buttonholes mark the length of the bead with chalk or a water-soluble pen on the fabric. For any subsequent buttonholes mark the starting point. The length of the keyhole is sewn additionally.



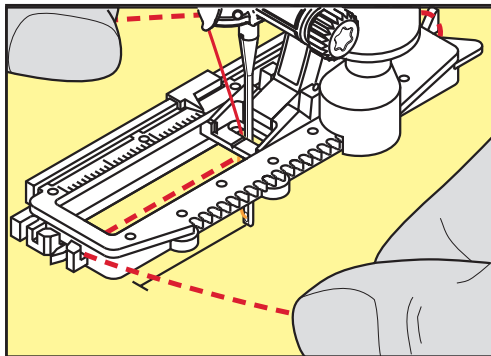
9.5 Cord

Using cord with the Buttonhole Foot with Slide #3A

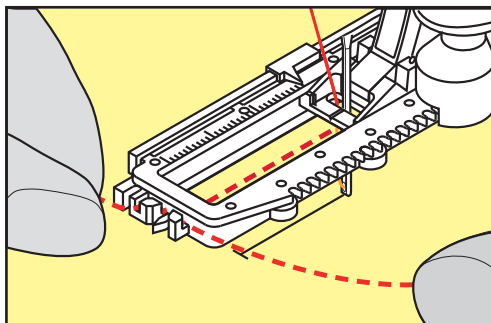
The cord reinforces and enhances the buttonhole and is particularly suitable for the Standard buttonhole No. 51. Optimal cord is Perle cotton No. 8, strong hand-sewing thread and fine crochet yarn. It is recommended not to hold the cord when sewing.

Prerequisite:

- The Buttonhole foot with slide #3A is fitted and raised.
- > Insert the needle at the beginning of the buttonhole.
- > Guide the cord on the right side under the buttonhole foot with slide.
- > Hook the cord over the pin at the back of the buttonhole foot with slide.

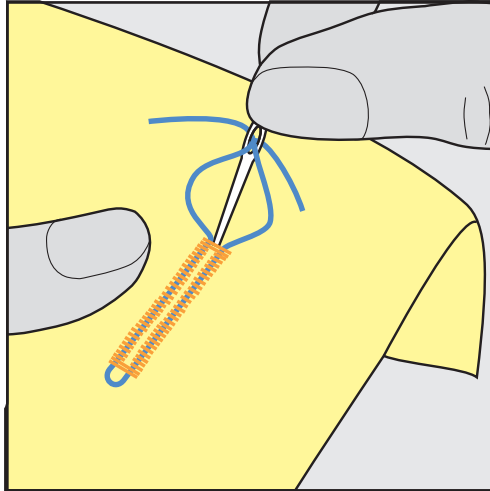


- > Pull the cord on the left side under the buttonhole foot to the front with slide.



- > Pull the cord ends into the slits.
- > Lower the buttonhole foot with slide.
- > Sew the buttonhole in the usual manner.
- > Pull the cord loop until the loop disappears in the bartack.

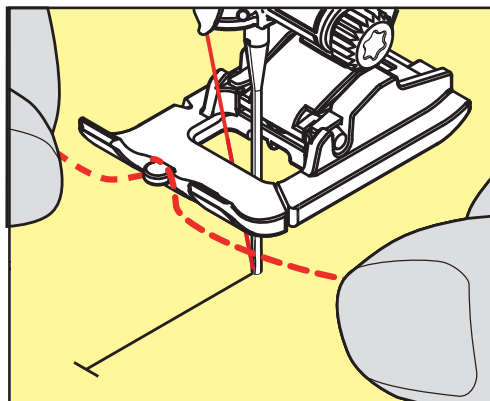
- > Pull the ends of the cord through to the wrong side of the fabric (using a hand stitching-needle), knot or secure with stitches.



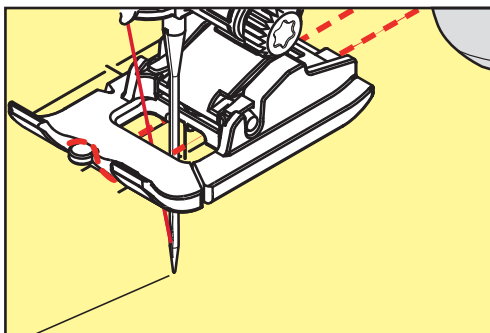
Using cord with the Buttonhole Foot #3

Prerequisite:

- The Buttonhole Foot #3C is fitted and raised.
- > Insert the needle at the beginning of the buttonhole.
- > Hook the cord over the pin at the back of the buttonhole foot.

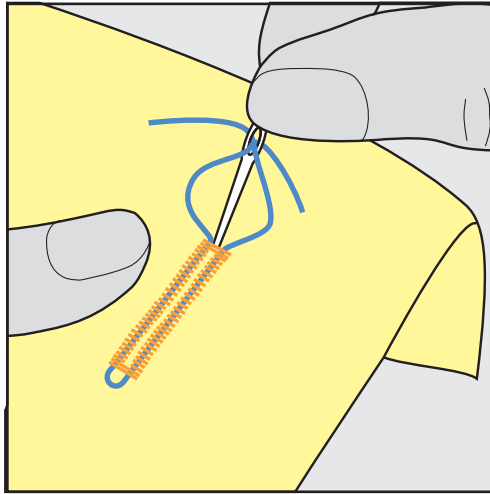


- > Pull both cords ends under the buttonhole foot to the back and place each a cord into a groove of the sole.



- > Lower the buttonhole foot.
- > Sew the buttonhole in the usual manner.
- > Pull the cord loop until the loop disappears in the bartack.

- > Pull the cord ends with the hand sewing needle to the back and knot or secure them.



9.6 Sewing a test sample

Always sew a test sample of the buttonhole on the same fabric: It is recommended to use the same stabilizer and to select the same buttonhole. The test sample should also be sewn in the respective direction. By sewing a test sample the settings can be adjusted until the sewing result is satisfying.

It is worth underlaying the buttonholes with the Straight stitch buttonhole No. 59 when working with soft loosely woven materials or for buttonholes which are highly stressed. This is also recommended to reinforce buttonholes in leather, vinyl or felt.

Alterations to the Balance when sewing a manual standard buttonhole as well as the keyhole and the round buttonhole with length measurement affect both beads in the same way. With the manual keyhole or round buttonhole the alterations affect both sides differently.

If the stitch counter function is used and alterations are made concerning the Balance, the alterations affect both buttonhole beads differently.



- > Tap «Buttonholes».
- > Select the buttonhole.
- > Select and fit the desired presser foot.
- > Place the fabric under the presser foot and lower the presser foot.
- > Press the foot control carefully and start sewing. Guide the fabric slightly.
- > Check the Balance while sewing and adjust if necessary.
- > Check the test sample and make further amendments if necessary.

9.7 Determining the buttonhole slit width

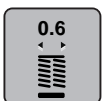
The width of the buttonhole slit can be adjusted between 0.1 – 2.0 mm before sewing.



- > Tap «Buttonholes».
- > Select the buttonhole.



- > Tap «i-Dialog».



- > Tap «Buttonhole Slit Width».
- > To adjust the desired width of the buttonhole slit, turn the Upper Multi-function knob or the «Lower Multi-function knob».

9.8 Determining the buttonhole length with the Buttonhole Foot with Slide #3A



The button can be placed in the yellow circle in the left section of the display. The yellow circle can be enlarged or downsized by turning the «Upper/Lower Multifunction knobs» and the diameter of the button can be determined in this way.

Additionally to the diameter of the button, 2 mm are added automatically for the buttonhole length. If the diameter of the button is 14 mm, the buttonhole length is calculated 16 mm.

Prerequisite:

- The Buttonhole foot with slide #3A is fitted.



- > Tap «Buttonholes».
- > Select the buttonhole.



- > Tap «i-Dialog».



- > Tap «Direct Entry Buttonhole Length».
- > Turn the «Upper Multi-function knob» or the «Lower Multi-function knob» to adjust the buttonhole length.

9.9 Determining the buttonhole length with Buttonhole Foot #3C

When the Buttonhole Foot #3C is used, the buttonhole length must be determined via the function Stitch Counter. The Stitch Counter function is suitable for all types of buttonholes. The left buttonhole bead is sewn forward, the right buttonhole bead is sewn in reverse. If alterations are made to the Balance, the Stitch Counter function has to be saved for every buttonhole separately.

Prerequisite:

- The Buttonhole Foot #3C is fitted.



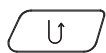
- > Tap «Buttonholes».
- > Select the buttonhole.



- > Tap «i-Dialog».

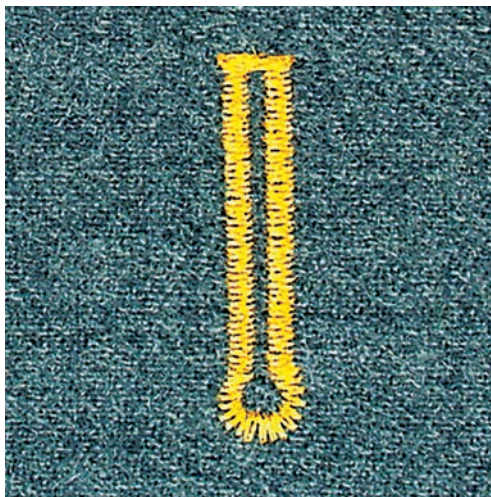
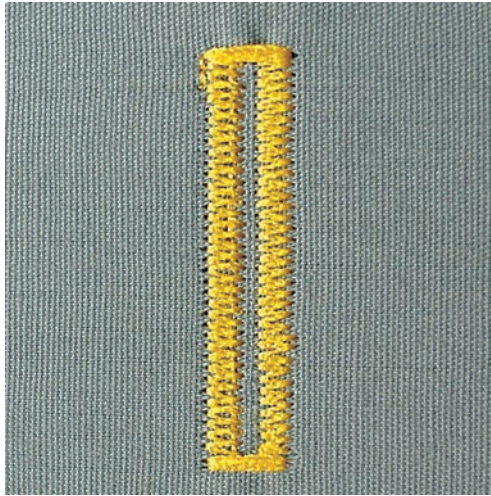


- > Tap «Programming the length via the Stitch Counter».
- > Sew the required length of the buttonhole.
- > Stop the machine.



- > The machine sews the lower bartack and the second bead in reverse when the button «Quick Reverse» is pushed.
- > Stop the machine at the height of the first stitch.
- > The machine sews the upper bartack and the securing stitches when the button «Quick Reverse» is pushed again.
 - The length of the buttonhole remains saved and every subsequent buttonhole is sewn identically until the machine is switched off.

9.10 Sewing a buttonhole automatically



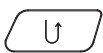
When the Buttonhole foot with slide #3A is used, the length of the buttonhole is measured automatically by the lens on the presser foot. The buttonhole will be exactly duplicated and the machine switches to the next step automatically when the maximum length is reached. The Buttonhole foot with slide #3A is suitable for buttonholes at a length of 4 – 31 mm, depending on the buttonhole type. The Buttonhole foot with slide #3A must lie perfectly flat on the fabric so that the length can be measured accurately. Programmed buttonholes are the same length and of the same nice look.

Prerequisite:

- The Buttonhole foot with slide #3A is fitted.



- > Tap «Buttonholes».
- > Select the buttonhole No. 51 – 59, No. 63 – 65, or No. 67 – 70.
- > Sew the required length of the buttonhole.



- > To program the length, push the button «Quick Reverse».



- > Push the button «Start/Stop» or press the foot control.
 - The machine finishes the buttonhole automatically. All subsequent buttonholes are sewn at the same length.

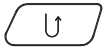
9.11 Programming the Heirloom buttonhole

Prerequisite:

- The Buttonhole foot with slide #3A is fitted.



- > Tap «Buttonholes».
- > Select Heirloom buttonhole No. 63.
- > Sew the required length of the buttonhole.



- > To program the length, push the button «Quick Reverse».
 - The machine finishes the buttonhole automatically. All subsequent buttonholes are sewn at the same length.

9.12 Sewing the manual 7-step buttonhole with the Buttonhole Foot #3C

The length of the beads is manually determined when sewing. Bartack, eye and securing stitches are preprogrammed. The individual steps can also be selected by scrolling via the arrow icons or by pushing the button. «Quick Reverse»

Prerequisite:

- The Buttonhole Foot #3C is fitted.



- > Tap «Buttonholes».
- > Select Standard buttonhole No. 51.



- > Tap «i-Dialog».



- > Tap «Manual Length Adjustment».
 - Step 1 is activated in the display for the start of the buttonhole.
- > Sew the required length of the buttonhole.
 - Step 2 is activated.



- > Stop when the required length of the buttonhole or length marking is reached.
- > Step 3 appears by tapping «Scroll down».
 - The machine sews straight stitches in reverse.
- > Stop at the height of the first stitch at the start of the buttonhole.
- > Step 4 appears by tapping «Scroll down».
 - The machine sews the upper bartack and stops automatically.
- > Step 5 appears by tapping «Scroll down».
 - The machine sews the second bead.
- > Stop the machine at the level of the last stitch of the first bead.

- > Step 6 appears by tapping «Scroll down».
 - The machine sews the lower bartack and stops automatically.
- > Step 7 appears by tapping «Scroll down».
 - The machine secures and stops automatically.

9.13 Sewing the manual 5-step buttonhole with the Buttonhole Foot #3C

The length of the beads is manually determined when sewing. Bartack, eye and securing stitches are preprogrammed. The individual steps can also be selected by scrolling via the arrow icons or by pushing the button. «Quick Reverse»

Prerequisite:

- The Buttonhole Foot #3C is fitted.



- > Tap «Buttonholes».
- > Select Round buttonhole with normal bartack No. 54.



- > Tap «i-Dialog».



- > Tap «Manual Length Adjustment».
 - Step 1 is activated in the display for the start of the buttonhole.
- > Sew the required length of the buttonhole.
 - Step 2 is activated.

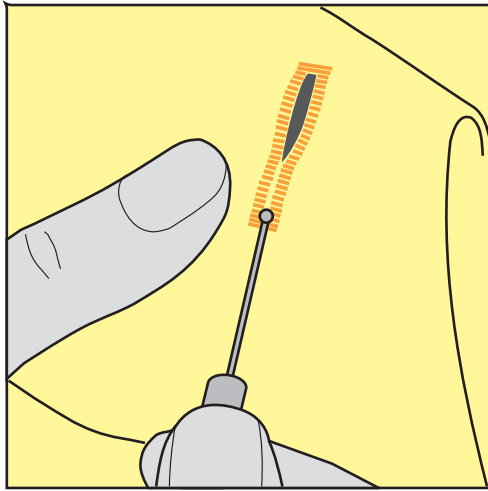


- > Stop when the required length of the bead or length marking is reached.
- > Step 3 appears by tapping «Scroll down».
 - The machine sews the curve or eye and stops automatically.
- > Step 4 appears by tapping «Scroll down».
 - The machine sews the second bead in reverse.
- > Stop the machine at the level of the first stitch at the beginning of the buttonhole.
- > Step 5 appears by tapping «Scroll down».
 - The machine sews the upper bartack and secures automatically.



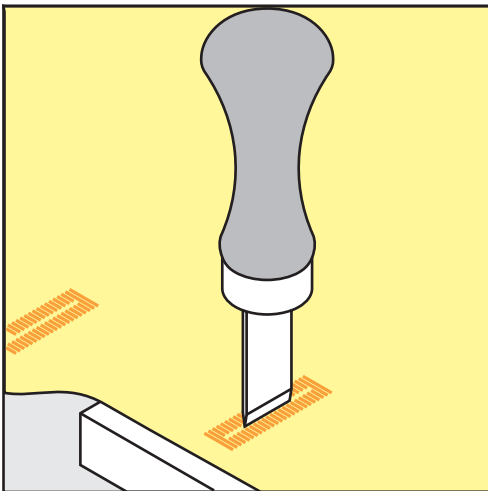
9.14 Cutting the buttonhole open with the seam ripper

- > Place a pin in each end of the buttonhole to avoid accidental cutting into ends of buttonhole.
- > Cut the buttonhole from both ends to the middle.



9.15 Cutting open buttonholes with the buttonhole cutter (optional accessory)

- > Place the fabric on an appropriate piece of wood.



- > Position the cutter in the center of the buttonhole.
- > Press down on the cutter with your hand.

9.16 Sewing on buttons

The Button Sew-on Program can be used to sew on buttons with two or four holes, press studs or snap fasteners.

Recommended Sewing Program: Button sew-on program No. 60

Recommended Presser Foot: Button Sew-On Foot #18

Alternative Presser Feet:

- Reverse Pattern Foot #1/1C
- Darning Foot #9
- Reverse Pattern Foot with Clear Sole #34/34C

Adjusting the thread shank

For buttons on thicker fabrics, increase the thread shank = the distance between the button and the fabric. Buttons sewn on thin fabrics or buttons for decorative purposes only are stitched without a «thread shank».

NOTICE! The adjustment of the thread shank is only possible when using the Button Sew-on Foot #18.

- > Loosen the screw on the back of the presser foot.
- > Push the bar upwards according to the thickness of the fabric.
- > Tighten the screw.

Sewing on a button

Prerequisite:

- The shank length is adjusted according the fabric thickness.
- The Button Sew-On Foot #18 or an alternative presser foot is fitted.
- The fitted presser foot has been selected in the user interface.
- The feed dog is lowered.



- > Tap «Buttonholes».
- > Select Button sew-on program No. 60.
- > Turn the handwheel until the bobbin thread comes up.
- > **NOTICE! The Button sew-on Program always starts above the left hole of the button.** Place the button on the fabric. Position the button and the fabric under the needle so that the needle stitches into the left hole.
For buttons with 4 holes, sew on the two front holes first, then the two back holes.
- > Lower the presser foot.
- > Perform the first stitches in the left hole via the handwheel.
- > Keep turning the handwheel until the needle changes the position to the right hole. Make sure that the needle hits the right hole. If required, adjust the stitch width via the Upper Multi-function knob.
- > Hold the threads and push the foot control.
 - The machine sews on the button and stops automatically.
- > For increased stability, sew the Button sew-on program again.
- > Cut the threads on the machine. Alternatively, pull the fabric from the sewing machine and cut the threads by hand. Pull the upper thread down and knot it with the lower thread.

9.17 Sewing eyelets



For increased stability sew the eyelet twice. If necessary, adjust the Balance.

Prerequisite:

- The Reverse Pattern Foot #1C or the Open Embroidery Foot #20C is fitted.





- > Tap «Buttonholes».
- > Select Eyelet with small zigzag No. 61 or Eyelet with straight stitch No. 62.
- > Turn the «Upper Multi-function knob» or the «Lower Multi-function knob» to alter the size of the eyelet.
- > Sew the Eyelet Program.
 - The machine stops automatically at the end of the Eyelet Program.
- > Use an awl, punch pliers or a hole punch to open the eyelet.

10 Quilting

10.1 Overview Quilt Stitches



Stitch pattern	Stitch number	Name	Description
.....	No. 1301	Quilting, securing program	To secure at the sewing start and sewing end with short forward stitches.
.....	No. 1302	Quilting, straight stitch	For machine quilting using a straight stitch with a 3 mm stitch length.
.....	No. 1303	Patchwork stitch/ straight stitch	For sewing patchwork parts together using a straight stitch with a 2 mm stitch length.
.....	No. 1304 – No. 1308	Hand-look quilt stitch	For attaching an imitation of hand-look stitch with monofilament.
⌌	No. 1309 – No. 1314	Blanket stitch	For applications and sewing on ribbons.
⌌	No. 1317 – No. 1327 No. 1329 – No. 1330 No. 1339 – No. 1346 No. 1363 – No. 1371 No. 1373 – No. 1394	Decorative quilt stitch	For quilting, crazy patchwork, embellishing and finishing.
	No. 1315	Satin stitch	For appliqué.
}	No. 1316	Narrow blind stitch	For hidden sewing of applications

Stitch pattern	Stitch number	Name	Description
	No. 1331	Stippling stitch/stippling quilt stitch	For imitations of stippling stitch.
	No. 1332 – No. 1338	Feather stitch	For quilting, crazy patchwork, embellishing and finishing.

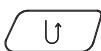
10.2 Quilting, Securing Program

Prerequisite:

- The Reverse Pattern Foot #1C is fitted.

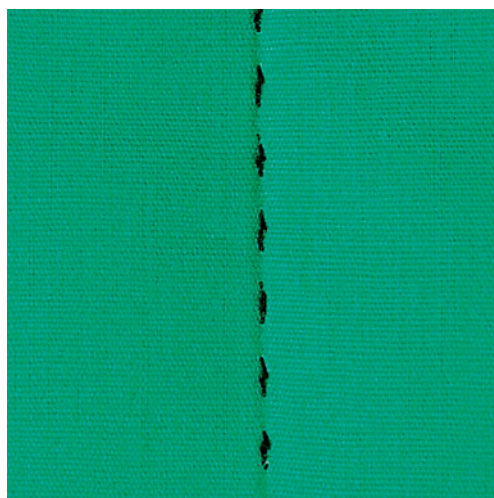


- > Tap «Quilt Stitches».
- > Select Quilting, securing program No. 1301.
- > Press the foot control.
 - The machine sews 6 stitches forward automatically when sewing is started.



- > Sew the seam in the desired length.
- > Push the button «Quick Reverse».
 - The machine sews 6 stitches forward automatically and stops automatically at the end of the Securing Program.

10.3 Sewing handlook quilt stitches



Handlook quilt stitches are suitable for all fabrics and sewing projects which should look hand sewn. It is recommended to use a monofilament thread as upper thread and an embroidery thread as bobbin thread. The sewing speed should be moderate to prevent the monofilament from breaking. If required, the upper thread tension and the Balance can be adjusted to the sewing project and the desired quilt stitch.

Prerequisite:

- The Reverse Pattern Foot #1C is fitted.



- > Tap «Quilt Stitches».
- > Select Hand-look quilt stitch No. 1304 No. 1308.
- > If necessary, adjust the upper thread tension and the balance to suit the sewing project and the desired quilt stitch.
- > To start the machine, press the foot control or push the button «Start/Stop».



10.4 Guiding the quilt work freely



Free-motion quilting and darning are based on the same free-motion principles. With stipple quilting, entire areas of the fabric are filled with quilt stitches. The single lines of stitching are rounded and must not cross each other.



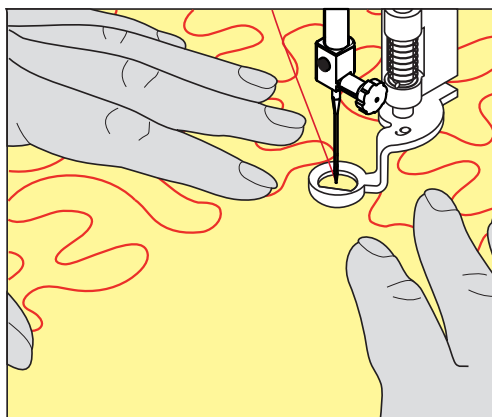
- Quilting gloves with rubber nubs make it easier to guide the fabric.
- For the best possible results use the High thread tension bobbin case (optional accessory).
- It is recommended to use the slide-on table and the Free Hand System.
- With free motion quilting, it is of advantage to quilt from the center outwards and to guide the fabric using smooth, round movements to form the design of your choice.

Prerequisite:

- The top layer, the batting and the backing are pinned together or basted.
- The feed dog is lowered.
- The Darning Foot #9 is fitted.



- > Tap «Practical Stitches».
- > Select Straight stitch No. 1.
- > If required, adjust the upper thread tension.
- > To prevent the fabric from shifting, select the needle position down.
- > To start the machine, press the foot control or push the button «Start/Stop».
- > To guide the fabric as if in a hoop, keep both hands close to the presser foot. Make sure that the needle does not pierce the same place several times in a row.
- > To ensure a minimum stitch distance when quilting corners, reduce the embroidery speed.
- > If the thread is lying on top of the fabric, slow down the movement.
- > If there are knots on the wrong side of the fabric, move the fabric more quickly.



11 BERNINA Stitch Regulator (BSR)

The BERNINA Stitch regulator equalizes the stitch length which results of the free movement of the fabric while free-motion sewing - a sewing technique which grows more and more popular. When free-motion sewing with the BSR presser foot, every stitch is equally long and the stitch formation is perfectly regular.

As soon as the BSR presser foot is attached and the feed dog is lowered, the selection menu of the desired mode appears in the display of the machine. The BSR presser foot can be used with sewing straight stitch as well as zig zag.

The BSR presser foot reacts on the movement of the fabric and therefore controls the speed of the machine up to the highest possible speed. It can be said: The faster the movement of the material, the higher the speed of the machine.

If the fabric is moved too quickly, an acoustic signal sounds. The beeper can be activated or deactivated in the «BSR» display. The sound of the beeper can also be activated or deactivated in the Setup Program.

11.1 BSR mode 1

The BSR function can be controlled via the foot control or with the button «Start/Stop». Start the BSR mode. At the BSR presser foot a red light is on. By moving the fabric the machine accelerates. If the fabric isn't moved, securing in place is possible without pressing an additional button. When working via the foot control or when using the button «Start/Stop», the BSR mode doesn't stop automatically.

11.2 BSR mode 2

The BSR function can be controlled via the foot control or the button «Start/Stop». The machine starts only when the foot control or the button «Start/Stop» is pressed and the fabric is moved simultaneously. Without moving the fabric, the BSR2 modus stops after about 7 seconds. The red light goes off (only when working with the button «Start/Stop»). When working via the foot control, the red light doesn't go off.

11.3 BSR mode 3

BSR mode 3 is stitching mode. In basting mode, you can choose between two stitch lengths:

- SPI 2: Two stitches per inch
- SPI 4: Four stitches per inch

11.4 BSR function with Straight stitch No. 1

This function allows free-motion quilting with straight stitch and a pre-programmed stitch length up to 4 mm. The programmed stitch length is maintained within a certain speed, independent of the fabric movement.

11.5 BSR function with Zigzag No. 2

The zig zag can be used e.g. for thread painting. The set stitch length will **not** be maintained when sewing the zig zag stitch, but the BSR function simplifies the application.

11.6 Sewing preparations for quilting

Attach the BSR presser foot

Prerequisite:

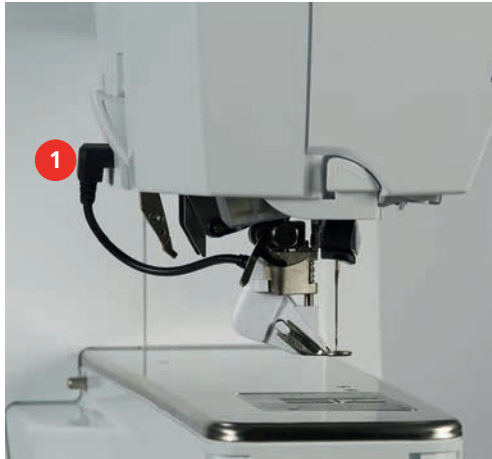
- The machine is switched off.

NOTICE

The lens of the BSR presser foot is dirty

The machine doesn't recognize the BSR presser foot.

- > Clean the lens with a soft, slightly damp cloth.
-
- > Change the presser foot.
 - > Insert the cable of the BSR Foot into the connection (1).



- > Switch the machine on.
 - The BSR display opens and the BSR1 Mode is activated.

Changing the presser foot sole

NOTICE

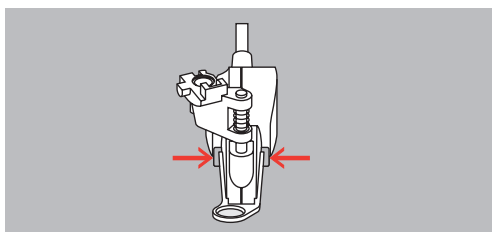
The lens of the BSR presser foot is dirty

The machine doesn't recognize the BSR presser foot.

- > Clean the lens with a soft, slightly damp cloth.

The standard stitch length is 2 mm. When sewing small shapes and stippling it is recommended to shorten the stitch length to 1 – 1.5 mm.

- > Raise the needle.
- > Raise the BSR foot.
- > Switch the machine off and disconnect it from the power supply system.
- > Remove the BSR foot from the machine.
- > Press both push buttons at the BSR foot against each other.



- > Pull the presser foot sole out of the guide downwards.
- > Insert the new presser foot sole into the guide and push upwards until it clicks into place.
- > Attach the BSR presser foot.

11.7 Using the BSR mode

The BSR function can either be operated via the foot control or via the button «Start/Stop».

Starting via the foot control: The foot control needs to be pressed while quilting. The machine keeps running in the BSR1 Mode until the foot control is released, even if the fabric isn't moved.

If quilting BSR2 Mode is stopped, the machine sews another stitch depending on the needle position and stops with needle position up.

Prerequisite:

- The Slide-on Freearm Extension Table has been fitted.
- The knee lifter of the Free Hand System is attached.

> Lower the feed dog.

> Select the desired BSR Mode.



> To lower the presser foot, push the button «Start/Stop» or press the foot control.

> To start the BSR Mode, push the button «Start/Stop» again or press and hold the foot control again.
– A red light is lit on the BSR Presser Foot.

> Move the fabric to control the speed of the machine in the BSR Mode.



> To stop the BSR Mode, push the button «Start/Stop» again or release the foot control.
– The BSR Mode stops and the red light at the presser foot goes off.



> To deactivate the BSR Mode and to quilt without automatic stitch lengths, tap «BSR Mode».



11.8 Securing

Securing in BSR1 Mode with the button «Start/Stop»

Prerequisite:

- The BSR Presser Foot is fitted and connected to the machine.
- The BSR display opens and a BSR1 Mode is active.

> Lower the feed dog.

> Lower the presser foot.



> Push the button «Needle Up/Down» 2x.
– The bobbin thread is brought up.

> Hold the upper and the bobbin thread.



> Push the button «Start/Stop».
– Start the BSR Mode.

> Sew 5 – 6 securing stitches.



> Push the button «Start/Stop».
– The BSR Mode stops.

> Cut the thread.

Securing in BSR2 Mode

Prerequisite:

- The BSR Presser Foot is fitted and connected to the machine.
- The BSR display opens and a BSR2 Mode is active.

- > Lower the presser foot.
- > Tap «i-Dialog».



- > Tap «Securing Stitches».



- > Press the foot control or push the button «Start/Stop».



By moving the fabric some short securing stitches are sewn, then the programmed stitch length is activated and the securing function is deactivated automatically.

11.9 Using the KickStart function

The KickStart function enables quilting without keeping the foot control pressed.

Prerequisite:

- The BSR Presser Foot is fitted and connected to the machine.
- The BSR display opens and a BSR Mode is active.

- > Tap «KickStart».
 - The KickStart display appears. The selected BSR Mode is displayed.
- > To start the machine, press the foot control **briefly** with your heel.
 - The machine starts sewing with the selected settings as soon as the fabric is moved.
- > To stop the machine, press the foot control briefly with your heel again.
 - The machine will stop, but the KickStart function will remain active.
- > To end the KickStart function, tap the screen or press the foot control at the front.
 - The BSR display appears.
 - The KickStart function will be deactivated.
 - The function programmed for the Back-kick will be active.



Please note

- While the KickStart function is active, the function programmed for Back-kick is deactivated. The Back-kick then only serves to start and stop the machine.
- The KickStart function will be ended immediately if the active monitoring function reports an error (e.g. thread breakage or bobbin empty).
- The KickStart function will be ended immediately if the foot control cable is unplugged.
- If there is no sewing in BSR Modes, the machine goes into Stand-by Mode after 7 seconds. Exit the Stand-by Mode by pressing the heel again.
- If no sewing is done for up to 60 seconds, the KickStart function is automatically terminated. The KickStart display disappears.

12 My BERNINA Embroidery

12.1 Overview Embroidery module



- | | | | |
|---|--------------------------------|---|-----------------------------|
| 1 | Embroidery arm | 3 | Guide rails for the machine |
| 2 | Coupling for securing the hoop | 4 | Connection to the machine |

12.2 Supplied accessories Embroidery module

Overview accessory Embroidery module









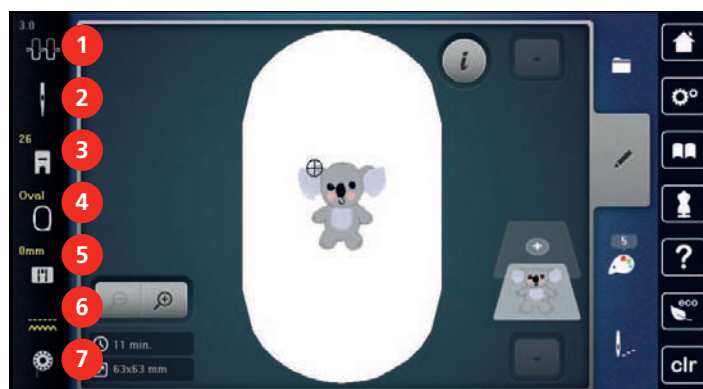
Illustration	Name	Purpose
	Embroidery Foot #26	For embroidering, darning and free-motion quilting.
	Large oval embroidery hoop	To embroider large embroidery motifs or motif combinations up to 145 x 255 mm (5.70 x 10.04 in). Including the template for precise fabric positioning.

Illustration	Name	Purpose
	Medium embroidery hoop	<p>To embroider medium-sized embroidery motifs up to 100 x 130 mm (3.94 x 5.12 in).</p> <p>Including the template for precise fabric positioning.</p>
	Small embroidery hoop	<p>To embroider small embroidery motifs up to 72 x 50 mm (2.83 x 1.97 in).</p> <p>For free arm embroidering with closed sewing projects such as sleeves, trouser legs or socks.</p> <p>Including the template for precise fabric positioning.</p>
	USB Connecting cable	To transfer data from the computer to the machine or vice versa.
	Embroidery needle assortment	For embroidering.
	Template holder	To place and remove the template in or out of the embroidery hoop.
	Spool net	For even thread unwinding with smooth threads from the thread spool, e.g. nylon, rayon, silk threads or metallic yarns.

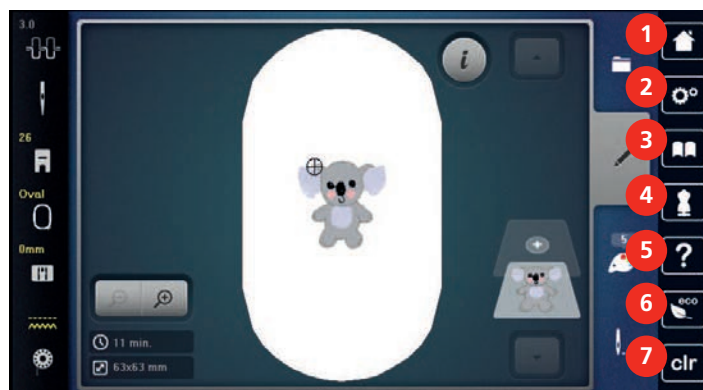
12.3 Overview User Interface

Overview functions/visual information



- | | | | |
|---|---|---|--------------------------|
| 1 | «Upper Thread Tension» | 5 | «Stitch Plate Selection» |
| 2 | «Needle Selection» | 6 | «Feed Dog Up/Down» |
| 3 | «Presser foot indicator / presser foot selection» | 7 | «Bobbin Thread» |
| 4 | «Hoop Indicator/Select Hoop» | | |

Overview System settings



- | | | | |
|---|-----------------------|---|------------------|
| 1 | «Home» | 5 | «Help» |
| 2 | «Setup Program» | 6 | «eco Mode» |
| 3 | «Tutorial» | 7 | «Clear Settings» |
| 4 | «Creative Consultant» | | |

Overview Selection menu embroidery



- | | | | |
|---|-------------|---|---------------------|
| 1 | «Selection» | 3 | «Color Information» |
| 2 | «Edit» | 4 | «Embroidery» |

12.4 Important Embroidery information

Upper thread

A good quality thread (brand manufacturer) is essential for embroidery so that the embroidery is not affected negatively because of poor thread or thread breakage.

Embroidery is particularly effective if you use 40wt glossy rayon or polyester embroidery threads as upper threads. They are available in a wide range of colors for beautiful embroidery.

- Glossy polyester with a brilliant sheen is a hard wearing, colorfast thread and has a high tensile strength which is suitable for all types of embroidery.
- Rayon is a soft viscose fiber with a brilliant sheen and suitable for fine, delicate embroidery, or items that will not receive excessive wear and tear.
- Metallic thread is a light to medium-weight thread suitable for special effects in embroidery.
- When working with metallic threads, the automatic bobbin thread cutter should be deactivated. The other thread cutters shouldn't be used either because the knives are likely to wear off very quickly.
- When using metallic threads, the speed and the upper thread tension should be reduced.



Bobbin thread

In most cases black or white bobbin thread is used for embroidering. When both sides should have the same look, it is recommended to use the same color for bobbin and upper thread.

- Bobbin Fill is an especially soft and light polyester thread which is suited well to be used as bobbin thread. This special bobbin thread ensures a steady thread tension and an optimal intertwining of the upper and bobbin thread.
- Darning and embroidery threads are fine mercerized cotton threads which are suitable for embroidery on cotton.



Choosing the embroidery motif

Simple motifs with a low stitch count are suitable for embroidery on fine material. Densely embroidered motifs, e. g. embroidered motifs with multiple color and embroidery direction changes, are suitable for medium and heavy-weight material.

Selecting the embroidery file format

In order that embroidery motifs can be read by the BERNINA embroidery machine, they must be created by the BERNINA Embroidery Software and exported as .EXP file. Besides the actual embroidery file, a .BMP file and an .INF file are generated additionally. The .BMP file allows a preview of the embroidery motif and the .INF file provides the information on the thread colors. **Please note:** If the .INF file is missing, the embroidery motif cannot be displayed in the correct thread colors but only in standard colors. In this case, the colors can be entered manually in the color overview of the motif on the machine.

Additionally, following embroidery formats can be read by the machine: .PES, .PEC, .XXX, .PCS, .JEF and .DST. BERNINA International AG provides no guarantee that embroidery motifs which have not been created or converted by a BERNINA Embroidery Software can be correctly read and embroidered.

Embroidery test

For the embroidery test, always use the original material reinforced with the same stabilizer as will be used later. For the embroidery test it is recommended to use the same colors, threads and needles which are planned to be used for the embroidery project.

The size of the embroidery motif

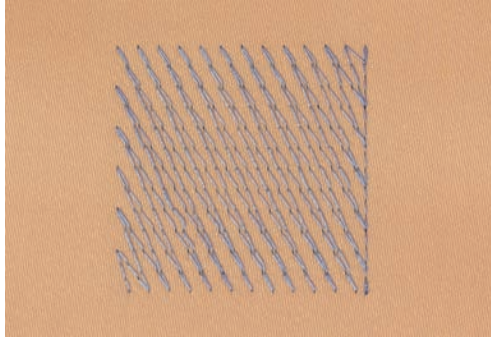
Embroidery motifs can be enlarged or downsized on the embroidery machine or on the PC using the BERNINA Embroidery software (optional accessory). Enlargements or reductions up to 20% achieve the best results.

Embroidering motifs by third-party providers

BERNINA recommends uploading embroidery motifs of any file format via the free program «ART-Link» to the machine or a USB stick. Using «ART-Link» ensures that the embroidery motif can be read and embroidered correctly. «ART-Link» can be downloaded for free at www.bernina.com.

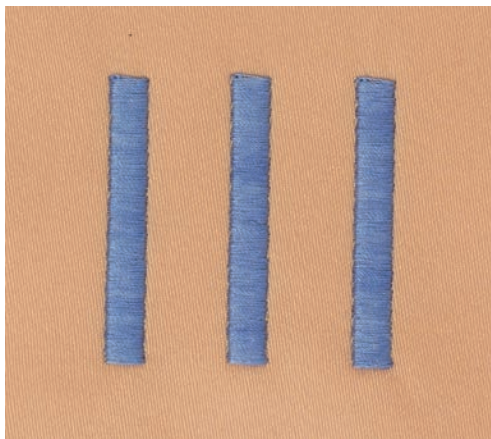
Underlay stitches

Underlay stitches are the foundation of a motif and are used to stabilize the base material and hold it in shape. They also prevent the covering stitches of the motif from sinking into the knit or the nap of the material.



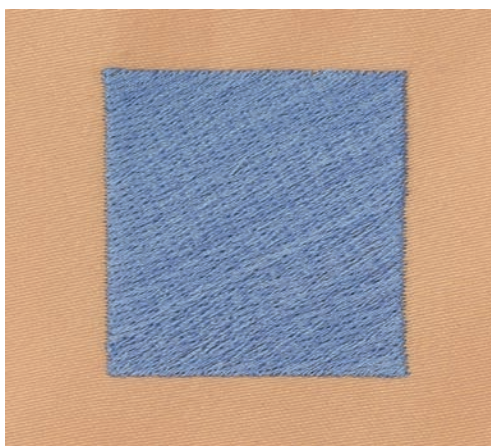
Satin or Leaf stitch

The needle moves left to right and vice versa. The result is a very dense, covering zigzag stitching to fill the shape. Satin stitching fills are ideal for narrow and small shapes. Satin stitching is, however, not suitable for larger areas, since wide stitches are too loose and do not cover the fabric properly. In addition there is the risk that with too long stitches the threads could catch on something which would damage the embroidery.



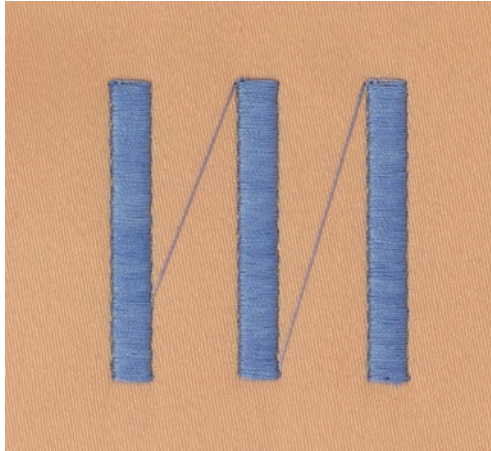
Step stitch

Many short, equally long stitches are embroidered in offset rows closely next to each other which results in a densely filled area.



Connecting stitches

Long stitches which are used to get from one part of the motif to the next. Before and after the connecting stitch securing stitches are sewn. Connecting stitches are trimmed.



13 Embroidering preparation

13.1 Attaching the Module

NOTICE

Transporting the embroidery module

Damage to the embroidery module connection and machine.

- > Remove the embroidery module before transporting the machine.

Prerequisite:

- The slide-on table must not be attached.
- > Make sure that the module and the machine are placed on a stable, even surface.
- > Make sure that there is enough space around to allow the unimpeded movement of the embroidery arm.
- > Lift the embroidery module on the left.
- > Carefully push the embroidery module from left to right into the embroidery module connection of the machine (1).



- > To remove the embroidery module, lift it on the left side and pull it carefully to the left.



13.2 Preparing the machine

Lowering the feed dog

- > Push the button «Feed dog up/down».



Selecting an embroidery motif

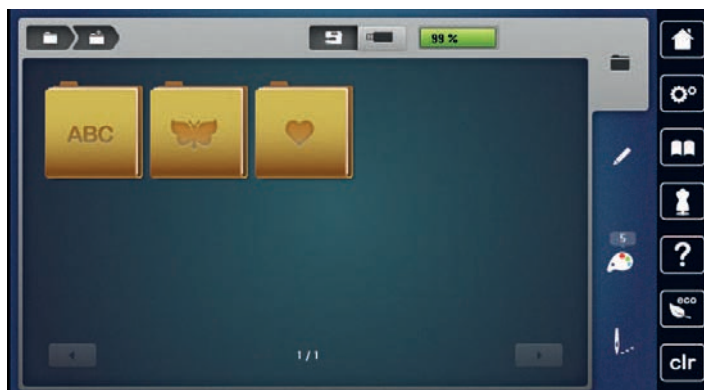
All embroidery motifs can either be embroidered as-is or they can be changed by using the various functions. You can find all embroidery motifs at the end of the instruction manual. Furthermore, embroidery motifs from the Personal Memory or from the BERNINA USB stick can be loaded.



- > Tap «Home».



- > Tap «Embroidery».
- > Select an alphabet, an embroidery motif, a stitch pattern or a personal embroidery motif from one of the files.



13.3 Embroidery foot

Attaching the embroidery foot

- > Raise the needle.
- > Raise the presser foot.
- > Switch the machine off and disconnect it from the power supply system.

- > Push the clamping lever up.



- > Remove the presser foot.
- > Insert the embroidery foot from below into the bracket.
- > Press the clamping lever down.

Selecting the presser foot in the User Interface

After having fitted the appropriate embroidery foot (Embroidery Foot #26, supplied accessory) it can be selected and saved on the machine. Moreover optional presser feet can be displayed which are available for the currently selected embroidery motif.

- > Switch the machine on.
- > Select an embroidery motif.
- > Tap «Presser foot indicator / presser foot selection».
- > Select the fitted embroidery foot.



13.4 Needle and stitch plate

Inserting the embroidery needle



Embroidery needles of the type 130/705 H-SUK provide a larger eye and are slightly rounded. This avoids thread abrasion when using Rayon- and cotton embroidery thread. Depending on the embroidery thread use a size No. 70-SUK to No. 90-SUK needle.

- > Raise the needle.
- > Switch the machine off and disconnect it from the power supply system.
- > Remove the attached foot.

- > Loosen the fixing screw of the needle using the screwdriver gray Torx.



- > Pull the needle down.
- > Hold the new needle with the flat side to the back.
- > Insert the needle as far as it will go.
- > Tighten the fixing screw of the needle using the screwdriver gray Torx.

Selecting the embroidery needle in the User Interface

After changing the needle, you can check whether this can be used with the selected stitch plate.



- > Tap «Needle Selection».
- > Select the fitted needle.



- If the selected needle is suitable in combination with the stitch plate, embroidering can be started.
- If the selected needle is not suitable in combination with the stitch plate, starting the machine is automatically blocked.

Selecting needle type and needle size

Convenient memory function: To prevent a loss of information, the needle type and the needle size can be saved additionally on the machine. The saved needle type and the saved needle size can be checked at any time.



- > Tap «Needle Selection».



> Tap «Needle Information».



- > Select the needle type (1) of the fitted needle.
- > Select the needle type (2) of the fitted needle.

Attaching the stitch plate

The stitch plate (CutWork/Straight, supplied accessory) has a small needle hole in the needle insertion area. The thread is pulled in and knotted optimally which results in an optimized stitching result.

- > To lower the feed dog, push the button «Feed dog up/down».



- > Switch off the machine and disconnect it from the power supply.
- > Remove the needle.
- > Remove the presser foot.
- > At the marking on the rear of the stitch plate, push the stitch plate downwards until it tips.



- > Remove the stitch plate.
- > Place the opening of the stitch plate (CutWork/Straight stitch plate) above the corresponding guide pins and press it down until it clicks into place.

Selecting the stitch plate in the User Interface

After changing the stitch plate, you can check whether this can be used with the selected needle.



- > Tap «Stitch Plate Selection».
- > Select the previously fitted stitch plate.



- If the selected stitch plate is suitable to be used in combination with the needle, sewing can begin.
- If the selected stitch plate is not suitable to be used in combination with the needle, an error message is displayed and starting the machine is automatically prevented.

Thread-up command

The machine must be ready for embroidery to bring up the bobbin thread. The bobbin thread can be brought up in one step for a manual knotting. If no securing stitches are wanted, it is recommended to deactivate the securing stitches in the Setup.



- > Hold the upper thread.
- > Push the button «Presser Foot Up/Down».
 - The bobbin thread is brought up automatically.

13.5 Embroidery hoop

Overview Embroidery hoop selection



1 Hoop selection

Selecting the embroidery hoop

The best embroidery result is achieved when the smallest possible embroidery hoop for the embroidery motif is selected.

The embroidery motif has a pre-set size which is displayed.

Prerequisite:



- The embroidery motif is selected.
- > Tap «Hoop Indicator/Select Hoop».
 - The machine selects the optimal embroidery hoop according to the size of the embroidery motif automatically. If the pre-set embroidery hoop would not be available, another desired embroidery hoop can be selected. When an embroidery hoop is attached which does not correspond with the selected one, the attached hoop is considered active and the embroidery motif area is displayed accordingly.
- > Select the desired embroidery hoop.

Tear-away stabilizers

Using a stabilizer ensures more stability of the embroidery project. A tear-away stabilizer suits all woven and non-stretch materials. 1 – 2 layers can be used. Stabilizers are available in different weights. With larger embroidered areas the stabilizer will remain under the embroidery thread. The stabilizer is applied to the wrong side of the fabric with temporary adhesive spray. Carefully tear away excess stabilizer after embroidering.

Cut-away stabilizers

Using a stabilizer ensure more stability of the embroidery project. A cut-away stabilizer suits all elastic materials. 1 – 2 layers can be used. Stabilizers are available in different weights. With larger areas to be embroidered the stabilizer will remain under the embroidery thread. The stabilizer is applied to the wrong side of the fabric with temporary adhesive spray. Carefully cut away excess stabilizer after embroidering.

Using adhesive spray

The application of spray adhesive is recommended for stretch and smooth materials and knitware. It prevents the fabric from losing shape and slipping. Appliqués can be exactly positioned with spray adhesive. The spray adhesive shouldn't be used near the machine to avoid contamination.

- > Use the adhesive spray carefully at a distance 25 – 30 cm (9 – 12 inch) when spraying the stabilizer.
- > Adhere the sprayed stabilizer to the wrong side of the fabric carefully, smoothing material so there are no puckers.
- > Position smaller parts such as pocket flaps or collars on the stabilizer.
- > To avoid the possibility of getting hoop marks when working with napped materials or fleece, don't hoop the parts but spray the stabilizer and hoop it.
- > Adhere the fabric to be embroidered.
- > Remove any adhesive residue before starting the machine.

Using spray starch

Spray starch is ideal for additional stiffening fine, loosely woven materials. Always use an additional stabilizer on the wrong side of the material.

- > Spray the area to be embroidered.
- > Let it dry or press gently with a warm iron if necessary.

Using iron-on interfacing

Iron-on interfacings are available in a variety of weights. It is recommended to use an iron-on interfacing which is easily removable from the basic fabric. An Iron-on interfacing suits all materials that are easily distorted like stretch fabric such as tricot and jersey.

- > Iron-on interfacings are ironed to the wrong side of the material using a warm iron.

Using paper-backed adhesive stabilizer

Paper-backed adhesive stabilizers are intended to be used for fabrics such as jersey and silk as well as for embroidery projects which are not suited to be hooped in the embroidery hoop.

- > Place the stabilizer in the hoop, so that the paper side is up.
- > Use a pair of scissors to score the paper and remove paper in the hoop area.
- > Position the fabric to be embroidered on the stabilizer and press it on place.
- > Remove any adhesive residue before starting the machine.

Using water-soluble stabilizer



For lace embroidery it is recommended to hoop 1 – 3 layers of water-soluble stabilizer in the embroidery hoop. As the embroidery motif is not embroidered on the fabric, only the thread embroidered motif is left. The embroidery motifs should be combined with short stitches otherwise the individual motifs may fall out.

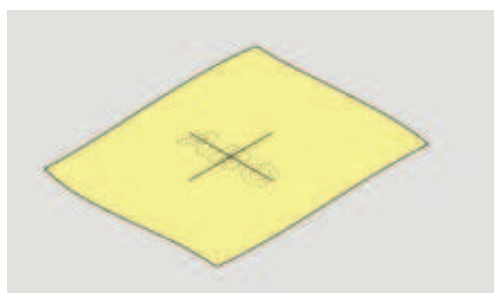
Water-soluble stabilizers are ideal for fine, sheer fabrics where other stabilizers may show through the embroidery stitches as well as for lace embroidery. The stabilizer dissolves in water. Water-soluble stabilizers are an ideal protection for looped pile fabrics preventing the loops from being damaged. It prevents threads from sinking into the material and keeps the fabric pile from poking through the embroidery.

- > Place the stabilizer on the underside of the material.
- > Use adhesive spray to adhere stabilizer if necessary.
- > For material with a pile, reinforce with additional, suitable stabilizer on the wrong side.
- > Place all the layers together into the embroidery hoop.
- > After dissolving, lay the motif down flat and let dry.

Preparing the embroidery hoop

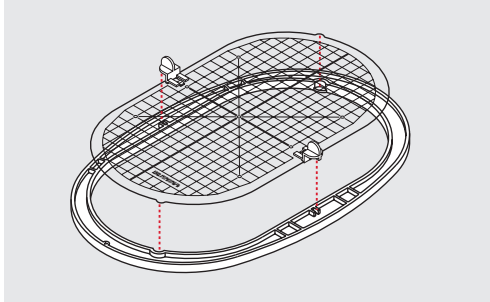
The embroidery hoop consists of an outer and an inner hoop. There is a corresponding template for every hoop. The area to be embroidered is marked in 1 cm (0.39 inch) squares. The center and corner points are marked with holes. The required marks can be transferred to the material.

- > Mark the center of an embroidery motif on the fabric, using a water-soluble pen.

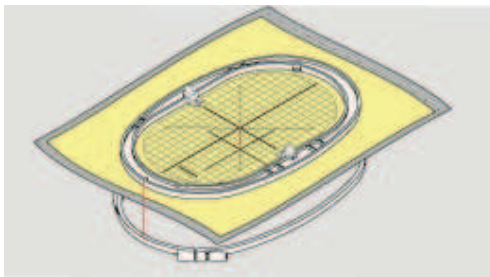


- > Loosen the screw on the outer hoop.
- > Remove the inner hoop.
- > Make sure that the arrows marks of both hoops match.
- > Attach the template holder.

- > Place the template in the inner hoop, so the BERNINA logo is at the front edge at the arrow mark until it clicks into place.



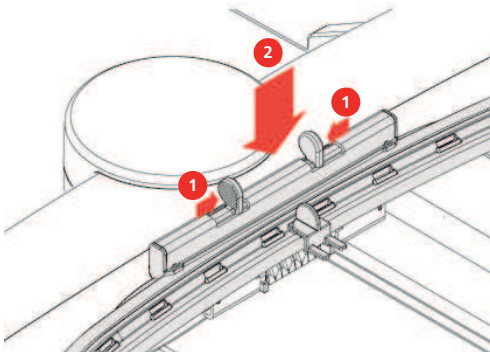
- > Place the material under the inner hoop.
- > Line up the marked center point on the center of the template.
- > Place the material and the inner hoop on the outer hoop so that the arrows of both hoops match.



- > Fit the hoops into each other; ensure that the material does not move.
- > Hoop the fabric to be embroidered tightly.
- > Tighten the screw.
- > Remove the template from the hoop by using the template holder.
- > To avoid scratches on the free arm, press the inner hoop into the outer hoop so that the inner hoop including the fabric protrudes downwards by up to 1 mm.

Attaching the hoop

- > Raise the needle.
- > Raise the embroidery foot.
- > Hold the hoop with the right side of the fabric up with the attaching mechanism to the left.
- > Position the hoop below the embroidery foot.
- > Press both attaching mechanisms (1) of the hoop towards each other.
- > Position the embroidery hoop (2) above the bracket of the embroidery arm.
- > Press the hoop down until it clicks in position.
- > Release the attaching mechanism (1).



- > Press the attaching mechanisms of the hoop towards each other to remove the hoop.
- > Remove the hoop.

Overview Embroidery functions



- | | | | |
|---|------------------------------------|---|---|
| 1 | «Center Embroidery Hoop to Needle» | 4 | «Grid On/Off» |
| 2 | «Move Hoop to the Back» | 5 | «Center Motif» |
| 3 | «Move Hoop to the Left» | 6 | «Virtual Positioning»
(becomes visible by scrolling) |

Center the needle to the embroidery hoop

Relocating the embroidery hoop facilitates threading when the needle is close to the embroidery hoop.



- > Tap «Hoop Indicator/Select Hoop».



- > Tap «Center Embroidery Hoop to Needle».
- > Thread the upper thread.



- > To move the hoop back to its previous position, push the button «Start/Stop».

Moving the hoop to the back

To facilitate changing the bobbin, it is recommended to move the hoop to the back before threading. This makes it easier to open the bobbin cover.



- > Tap «Hoop Indicator/Select Hoop».



- > Tap «Move Hoop to the Back».
- > Thread the bobbin thread. (see page 48)



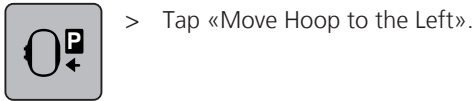
- > To move the hoop back to its previous position, push the button «Start/Stop». If necessary, pull back the upper thread.

Moving the module for the sewing mode

The embroidery module can be positioned so that any sewing projects can be carried out even if the module is connected.



- > Tap «Hoop Indicator/Select Hoop».
- > Remove the embroidery hoop.



> Tap «Move Hoop to the Left».



> Tap «Home».



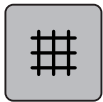
> Tap «Sewing Mode».

Grid on/off

When the center of the hoop and the grid are displayed, the embroidery motif can be positioned more exactly.



> Tap «Hoop Indicator/Select Hoop».



> To show the hoop center on the display, tap «Grid On/Off».

> To show the grid lines, tap «Grid On/Off» again.

> To hide the hoop center and the grid lines, tap «Grid On/Off» again.

Locating the center of the embroidery motif

The embroidery hoop is positioned so that the needle is exactly above the center of the embroidery motif or the motif begin.



> Tap «Hoop Indicator/Select Hoop».



> To position the hoop so that the needle is placed exactly over the center of the embroidery motif, tap «Center Motif».

> To position the hoop so that the needle is placed exactly over the motif start, tap «Center Motif» again.

Virtual positioning of the embroidery hoop

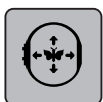
The embroidery hoop is automatically moved to the new position as soon as the embroidery motif is repositioned. Therefore the icon «Virtual Positioning» is activated automatically and outlined in yellow when an embroidery hoop is attached.

Prerequisite:

- The hoop is attached.



> Tap «Hoop Indicator/Select Hoop».



> To deactivate the automatic movement of the hoop after repositioning the embroidery motif, tap «Virtual Positioning».

- The «Virtual Positioning» is not yellow-outlined.

> To activate the automatic movement of the hoop after repositioning the embroidery motif, tap «Virtual Positioning» again.

14 Setup Program

14.1 Adjusting the embroidery settings in the Setup Program

Further information about this topic (see page 55).

15 Creative embroidering

15.1 Overview embroidering



- | | | | |
|---|---|---|-------------------------|
| 1 | Embroidery time/Embroidery Motif Size | 4 | «i-Dialog» |
| 2 | Scaling up, downsizing and moving the embroidery motif view | 5 | Embroidery motif layers |
| 3 | Area to be embroidered | | |

15.2 Selecting and changing the embroidery motif



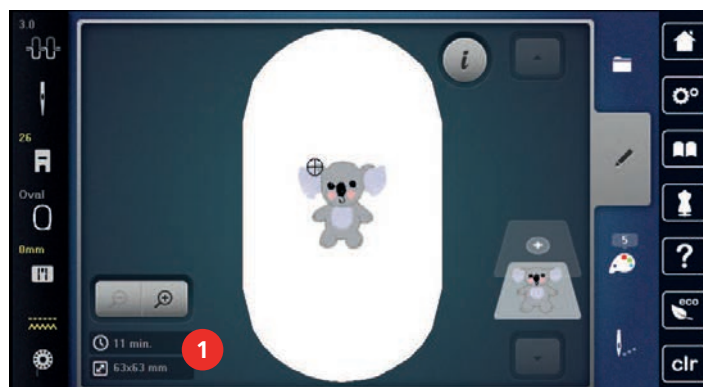
- > Tap «Selection».



- > Tap «Load Embroidery Motif».
- > Select a new embroidery motif.

15.3 Checking the embroidery time and the embroidery motif size

In the selection menu «Edit» the estimated embroidery time in minutes as well as the width and height of the embroidery motif is indicated at lower left (1).



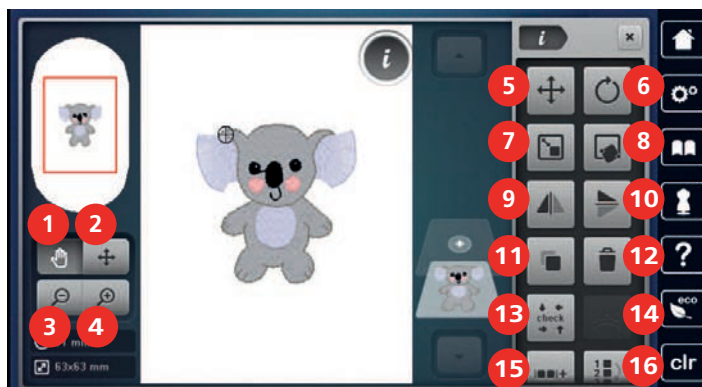
15.4 Regulating the speed

The sewing speed can be adjusted infinitely variable with the slide.

- > Move the slide to the left to reduce the sewing speed.
- > Move the slide to the right to increase the sewing speed.

15.5 Editing the embroidery motif

Overview Editing embroidery motif



- | | | | |
|---|-------------------------------|----|--|
| 1 | «Move View» | 10 | «Mirror Image Up/Down» |
| 2 | «Relocating a stitch pattern» | 11 | «Duplicating» |
| 3 | «Zoom Out» | 12 | «Delete» |
| 4 | «Zoom In» | 13 | «Check Embroidery Motif Size» |
| 5 | «Relocating a stitch pattern» | 14 | «Bend Text»
(activated after text entry) |
| 6 | «Rotate Embroidery Motif» | 15 | «Group Embroidery Motifs» |
| 7 | «Change Motif Size» | 16 | «Change Embroidery Motif Sequence»
(becomes visible by scrolling) |
| 8 | «Pinpoint Placement» | 17 | «Alter Stitch Type/Stitch Density»
(becomes visible by scrolling) |
| 9 | «Mirror Image Left/Right» | | |

Scaling up the embroidery motif view

The view of the embroidery motif can be scaled up. In addition to that, the view can be adjusted with or without changing the embroidery position.



- > Select an embroidery motif.
- > To edit the view of the embroidery motif, tap «Zoom In».



- > To scale up the view of the embroidery motif, tap «Zoom In» 1 up to 4 times.



- > To get back to the Edit Mode, tap «Zoom Out» 1 up to 4 times.

Downsizing the embroidery motif view

The view of the embroidery motif can be downsized. In addition to that, the view can be adjusted with or without changing the embroidery position.



- > Select an embroidery motif.
- > To edit the view of the embroidery motif, tap «Zoom In».



- > To downsize the view of the enlarged embroidery motif gradually, tap «Zoom Out» 1 – 4 times.

Moving the embroidery motif view

The view of the embroidery motif can be moved. In addition to that, the view can be adjusted with or without changing the embroidery position.



- > Select an embroidery motif.
- > To activate «Move View», tap «Zoom In».
 - «Move View» is activated (dark gray).
- > Move the view of the embroidery motif.
 - The embroidery position is not altered.



- > To get back to the Edit Mode, tap «Zoom Out».

Moving the embroidery motif in enlarged view

The view of the embroidery motif can be moved. In addition to that, the view can be adjusted with or without changing the embroidery position.



- > Select an embroidery motif.
- > To display the icon «Relocating a stitch pattern», tap «Zoom In».



- > Tap «Move Embroidery Motif».
 - The icon turns dark gray.
- > Move the view of the embroidery motif.
 - The embroidery position is altered.

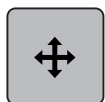


- > To get back to the Edit Mode, tap «Zoom Out».

Moving the embroidery motif



- > Select an embroidery motif.
- > Tap «i-Dialog».



- > Tap «Move Embroidery Motif».
- > Turn the «Upper Multi-function knob» to move the embroidery motif horizontally in 1/10-mm steps.
- > Turn the «Lower Multi-function knob» to move the embroidery motif vertically in 1/10 mm steps or tap and hold the embroidery motif to move the embroidery motif as you like.
 - The relocation is indicated in the yellow-outlined icons.

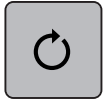


- > Tap «Center Motif».
 - The embroidery motif is repositioned in the center of the embroidery hoop.

Rotating motif



- > Select an embroidery motif.
- > Tap «i-Dialog».



- > Tap «Rotate Embroidery Motif».
- > Turn the «Upper Multi-function knob» or the «Lower Multi-function knob» to the right to rotate the embroidery motif clockwise.
- > Turn the «Upper Multi-function knob» or the «Lower Multi-function knob» to the left to rotate the embroidery motif counter-clockwise.



- > To rotate the embroidery motif in 90°-steps, tap «Rotate the embroidery motif +90°».

Altering the embroidery motif size proportionally



Enlargements or reductions of the motif size up to maximum 20% achieve the best results.

If the motif size is to be altered by more than 20%, the motif should be adapted in a separate embroidery software and then reloaded onto the machine.



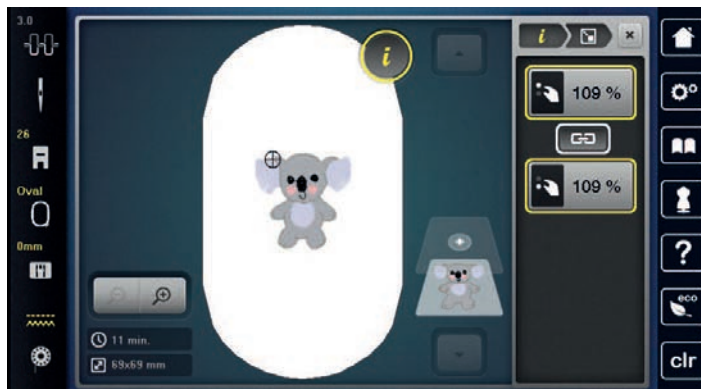
- > Select an embroidery motif.
- > Tap «i-Dialog».



- > Tap «Change Motif Size».



- > If «Retain proportions» is not outlined in white, tap «Retain proportions».
 - «Retain proportions» is outlined in white.



- > Turn the «Upper/Lower Multi-function knob» to the right to scale up the embroidery motif proportionally.
- > Turn the «Upper/Lower Multi-function knob» to the left to downsize the embroidery motif proportionally.

Altering the embroidery motif size disproportionately



Enlargements or reductions of the motif size up to maximum 20% achieve the best results.

If the motif size is to be altered by more than 20%, the motif should be adapted in a separate embroidery software and then reloaded onto the machine.



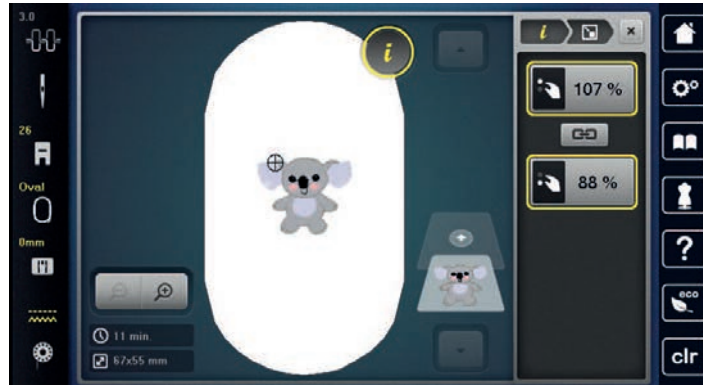
- > Select an embroidery motif.
- > Tap «i-Dialog».



- > Tap «Change Motif Size».



- > If «Retain proportions» is outlined in white, tap «Retain proportions».
- «Retain proportions» is not outlined in white.



- > To make the embroidery motif wider, turn the «Upper Multi-function knob» clockwise.
- > To make the embroidery motif narrower, turn the «Upper Multi-function knob» anti-clockwise.
- > To make the embroidery motif longer, turn the «Lower Multi-function knob» clockwise.
- > To make the embroidery motif shorter, turn the «Lower Multi-function knob» anti-clockwise.

Mirroring embroidery motifs

Embroidery motifs can be mirror-imaged both vertically and horizontally.



- > Select an embroidery motif.
- > Tap «i-Dialog».



- > To mirror the embroidery motif horizontally, tap «Mirror Image Left/Right».



- > To mirror the embroidery motif vertically, tap «Mirror Image Up/Down».

Bending the text

Texts can be arranged and designed arc-shaped.

- > Create an alphabet embroidery motif.



> Tap «i-Dialog».



> Tap «Bend Text».

> To change the distance between the characters in increments of one millimeter, turn the «Upper multifunction knob».

> Turn the «Lower multifunction knob» to the left or right to curve the writing upwards or downwards.

Changing the stitch type

If the satin stitches are too long, they can be changed to step stitches.



> Select an embroidery motif.

> Tap «i-Dialog».



> Tap «Alter Stitch Type/Stitch Density».



> Touch the switch in the upper section of the display (1) to change the satin stitch to the step stitch.

> Set the stitch length to 2.

Altering the stitch density

If the satin stitches are embroidered too densely, the stitch density can be adjusted.



> Select an embroidery motif.

> Tap «i-Dialog».



> Tap «Alter Stitch Type/Stitch Density».

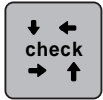


> Adjust the stitch density (1).

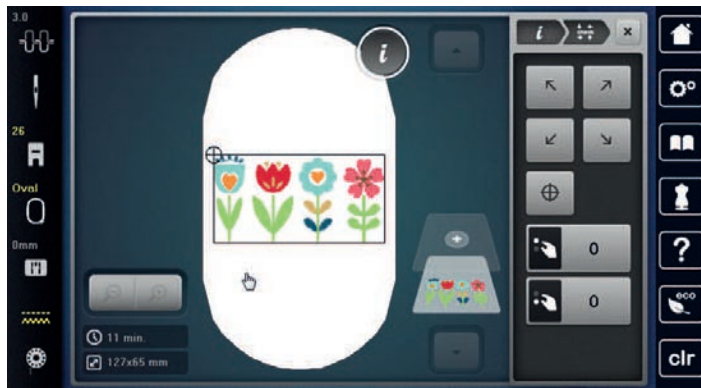
Checking the size and the position of the embroidery motif

It can be checked whether or not the embroidery motif matches the designated position/location on the fabric. Points which are beyond the embroidery hoop are not traveled to.

- > Select an embroidery motif.
- > Tap «i-Dialog».



- > Tap «Check Embroidery Motif Size».
 - The embroidery hoop travels all the way until the needle is at the position as it is indicated in the display.



- > To select the desired corner of the embroidery motif, tap the respective arrow.
 - The embroidery hoop travels all the way until the needle is at the position as it is indicated in the display. If the embroidery motif hasn't been positioned correctly yet, the position can be altered via the Upper/Lower Multi-function knobs and the complete embroidery positions can be checked again.



- > To position the needle in the center of the embroidery motif, tap «Center Motif».
- > Turn the «Upper Multi-function knob» to move the embroidery motif horizontally.
- > Turn the «Lower Multi-function knob» to move the embroidery motif vertically.

Deleting an embroidery motif

The active embroidery motif is deleted.

- > Select an embroidery motif.
- > Tap «i-Dialog».



- > Tap «Delete».

Changing the sequence within an embroidery motif combination

The sequence of the embroidery motifs in the embroidery motif combination can be changed.

Prerequisite:

- The embroidery motif combination has been created or the motif has been ungrouped.

- > Tap «i-Dialog».





- > Tap «Change Embroidery Motif Sequence».
- > Select the required embroidery motif and move it to the corresponding position.

Grouping embroidery motifs

Embroidery motifs can be added to or removed from a group. The grouped embroidery motifs can be processed in the same way as for one embroidery motif.

The sequence of the embroidery motifs in the group can be changed. (see page 155)

If the grouping of a embroidery motif has been canceled, i.e. the embroidery motif has been broken down into different elements/colors, the colors are no longer combined for new groupings. With alphabets, the length of the connecting stitches must first be set to 1 in the setup. The cancellation of the group then works for all letters.

- > Create an embroidery motif combination.
- > Select the embroidery motif (1) in the embroidery motif combination.



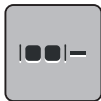
- > Tap «i-Dialog».



- > Tap «Group Embroidery Motifs».



- > Tap «Group».
 - Embroidery motifs above the selected embroidery motif are added to the embroidery motif group.
- > Select the embroidery motif group.



- > Tap «Ungroup».
 - The grouping is canceled.

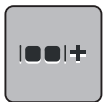
or

- > Create an embroidery motif combination.

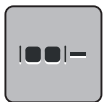
- > Select all embroidery motifs (2).



- > Tap «i-Dialog».



- > Tap «Group».
 - All embroidery motifs are added to the embroidery motif group.
- > Select the embroidery motif group.



- > Tap «Ungroup».
 - The grouping is canceled.

15.6 Pinpoint placement

Positioning of grid points

This function allows the exact positioning of the embroidery motif on the fabric in an easy way. The positioning points can be placed in the grid.

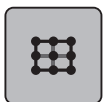
Prerequisite:

- Any two points of the embroidery motif are marked with chalk or a water-soluble pen on the fabric. The place or the location where the embroidery motif is to be positioned is clearly visible.

- > Select an embroidery motif.
- > Tap «i-Dialog».



- > Tap «Pinpoint Placement».



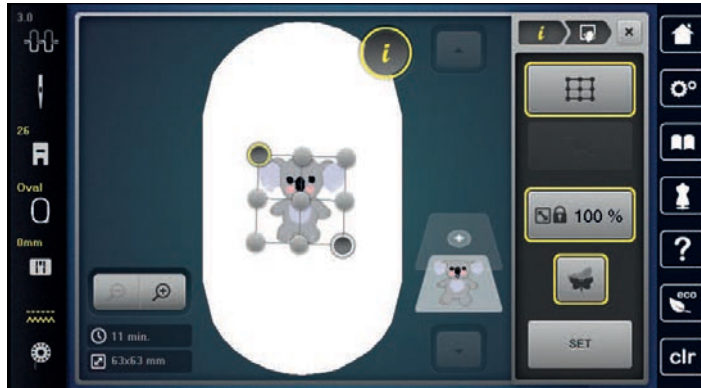
- > Tap «Grid Point Positioning».
 - The embroidery motif is given a grid with nine different location/positioning points.



- > To prevent the size of the embroidery motif from being changed when positioning the points, tap «Scale the Size of Embroidery Motif».
- > Select the desired positioning point to which the embroidery motif is to be adjusted.
 - The point changes color.
- > Turn the «Upper Multifunctional knob» or the «Lower Multifunctional knob» to the left or to the right to position the needle above the respective mark on the fabric.

SET

- > To confirm the changed position, tap «Save Position».
 - The point changes color and is set.
- > Select the second positioning point of the embroidery motif.
- > Turn the «Upper Multifunctional knob» or the «Lower Multifunctional knob» to the left or to the right to position the needle above the respective mark on the fabric.



- > To confirm the changed position, tap «Save Position».
 - The point changes color and is set. The embroidery motif is adjusted accordingly.



- > To reset the changes and revert to the default settings, tap «Reset Pinpoint Placement».

Free point positioning

This function allows the exact positioning of the embroidery motif on the fabric in an easy way. The points can be defined as you like within the embroidery motif.

Prerequisite:

- Any two points of the embroidery motif are marked with chalk or a water-soluble pen on the fabric. The place or the location where the embroidery motif is to be positioned is clearly visible.

- > Select an embroidery motif.
- > Tap «i-Dialog».



- > Tap «Pinpoint Placement».



- > Tap «Free Point Positioning».



- > To prevent the size of the embroidery motif from being changed when positioning the points, tap «Scale the Size of Embroidery Motif».
- > Define a desired point within the embroidery motif.
 - The positioning point is displayed.

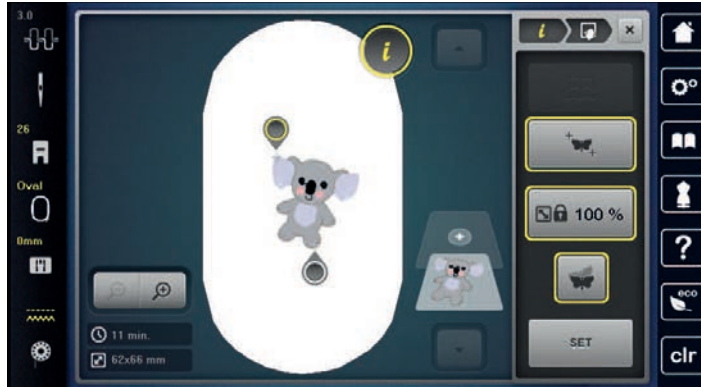


- > Turn the «Upper Multifunctional knob» or the «Lower Multifunctional knob» to the left or to the right to position the needle above the respective mark on the fabric.

SET

- > To confirm the changed position, tap «Save Position».
 - The point changes color and is set.
- > Select the second positioning point of the embroidery motif.

- > Turn the «Upper Multifunctional knob» or the «Lower Multifunctional knob» to the left or to the right to position the needle above the respective mark on the fabric.



- > To confirm the changed position, tap «Save Position».
 - The point changes color and is set. The embroidery motif is adjusted accordingly.
- > To reset the changes and revert to the default settings, tap «Reset Pinpoint Placement».



15.7 Combining embroidery motifs

Combining embroidery motifs

In the Combi-mode several embroidery motifs can be combined.

- > Select an embroidery motif.
- > Tap «Add Embroidery Motif».



- > Select another embroidery motif.

Deleting a single embroidery motif

Prerequisite:

- A combination of embroidery motifs has been created.
- > Tap the desired embroidery motif in the area of the embroidery motif level (1), keep it touched and drag it outwards.
 - A new window opens.
- > To delete the selected embroidery motif, tap «Confirm».

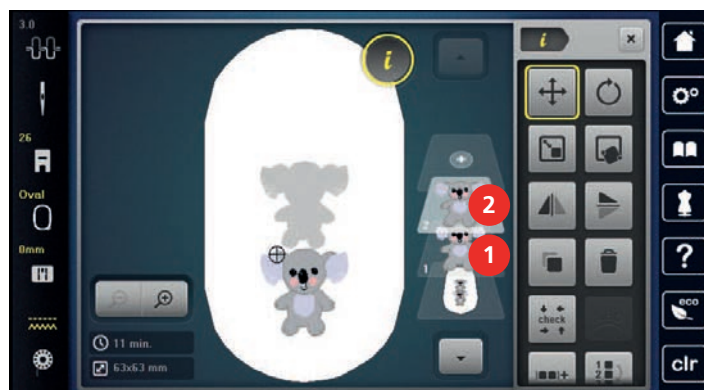


Duplicating the embroidery motif

- > Select an embroidery motif.
- > Tap «i-Dialog».



- > Tap «Duplicating».
- The embroidery motif (1) is duplicated (2).



Duplicating a combination

When a combination is duplicated, the individual embroidery motifs cannot be selected anymore.

- > Select an embroidery motif.
- > Tap «Add Embroidery Motif».
- > Select another embroidery motif.
- > Select the combination (1).



- > Tap «i-Dialog».



- > Tap «Duplicating».
- The combination is duplicated (2).



15.8 Creating lettering

Overview embroidery alphabets

Embroidery motif	Name
ABC	Swiss Block
<i>ABC</i>	Anniversary
Abc	Alphabet Guinevere
ABC	Drifter
ABC	Childs Play
АБВ	Russian Textbook
<i>ABC</i>	Curly
ABC	Rounded Sans

Creating words/sentences



Lettering is always embroidered in one color. To embroider single letters or single words in another color, every letter or every word has to be selected individually and placed in the area to be embroidered.

Lettering can be positioned within the hoop as you like. When the embroidery motif is positioned outside the area to be embroidered, the hoop is outlined in red on the display. With the hoop selection it can be checked whether or not the embroidery motif can be embroidered in another hoop. When the lettering does not fit in any hoop, two single words can be combined and positioned below each other as the following example will show.



- > Select «Alphabets».
- > Select the font.
- > Enter the text «Made to».



- > to use upper-case letters, tap «Upper Case Characters» (standard setting).



- > To use lower-case letters, tap «Lower Case Characters».




- > To use figures and mathematical symbols, tap «Numbers and Mathematical Characters».

 > To use special characters, tap «Special Characters».



> Tap the text box above the keyboard to delete the entered text completely.
 > To delete single letters of the entered text, tap «Delete».



 > To accept the text, tap «Confirm».

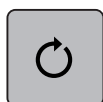


> Tap «Hoop Indicator/Select Hoop».
 > Select the hoop.
 > To get back to the Edit Mode, tap, «Hoop Indicator/Select Hoop» again.

Editing words/sentences



> Tap «i-Dialog».



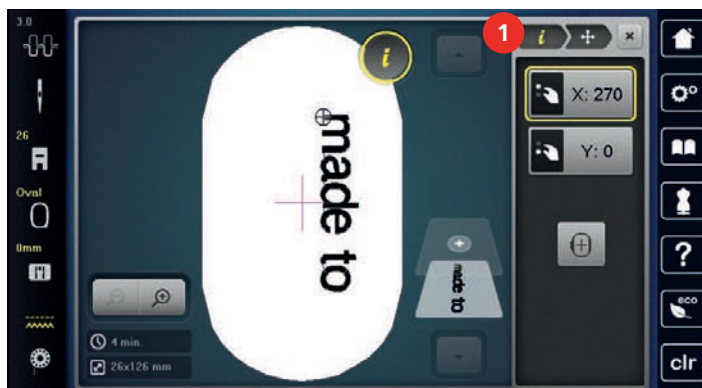
> Tap «Rotate Embroidery Motif».



> To rotate the text by 90°, tap «Rotate the embroidery motif +90°».
 > Tap «i» (1) in the Process Navigation.



> Tap «Move Embroidery Motif».
 > Turn the «Upper Multi-function knob» to move the embroidery motif horizontally.
 > Turn the «Lower Multi-function knob» to move the embroidery motif vertically.

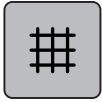




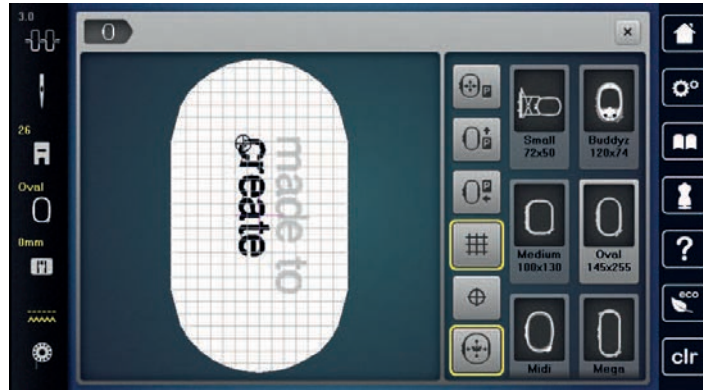
- > Tap «Add Embroidery Motif».
- > Enter the text and rotate it if necessary.



- > Tap «Hoop Indicator/Select Hoop».



- > To position the text lines more precisely, tap «Grid On/Off».



15.9 Changing the colors of the embroidery motif

Overview changing the color

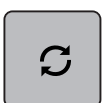


- | | | | |
|---|----------------------------|---|------------------------|
| 1 | «Color indication» | 4 | «Altering color/brand» |
| 2 | Preview for selected color | 5 | «Color Information» |
| 3 | «Assign Thread Brand» | | |

Changing the colors



- > Select an embroidery motif.
- > Tap «Color Information».



- > To change a color, tap «Altering color/brand» next to the color to be changed.
- > To display additional colors, swipe up or down on the display.

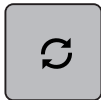


- > To select the color by entering the color number, tap «Color selection via number».
- > Enter the number for the required color.
 - The color icon is displayed on the left.
- > To confirm the color selection, touch the color icon that is displayed on the left.

Changing the thread brand



- > Select an embroidery motif.
- > Tap «Color Information».



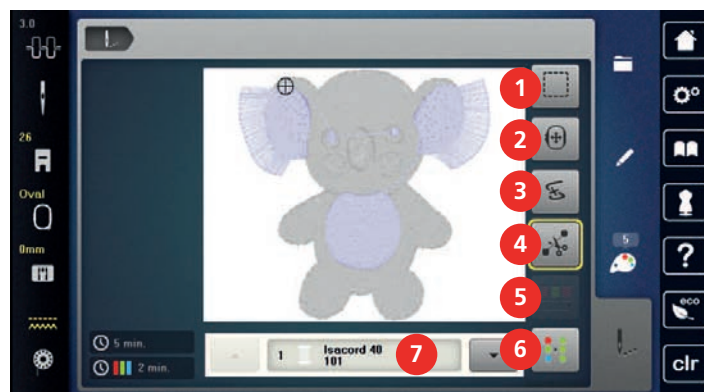
- > Tap «Altering color/brand».
- > To display other thread brands, scroll to the left and to the right.



- > Tap «Assign Thread Brand».
- Any thread colors of the selected embroidery motif will be matched with the selected thread brand.

15.10 Embroidering the embroidery motif

Overview Embroidery menu



- | | |
|---------------------------------|---|
| 1 «Basting» | 5 «Reduce Color Changes» |
| 2 «Move Hoop» | 6 «Multi-colored Embroidery Motif On/Off» |
| 3 «Embroidery Sequence Control» | 7 «Color indication» |
| 4 «Cut Connecting Stitches» | |

Adding basting stitches

The basting stitches can be embroidered along the embroidery motif. This gives the fabric and embroidery stabilizer a better hold.



- > Select an embroidery motif.
- > Tap «Embroidery».



- > To embroider the basting stitches along an embroidery motif, tap «Basting».
- > To deactivate the basting stitches, tap «Basting» again.

Moving the hoop

If the embroidery motif is so big that repeated rehooping is necessary, the embroidered motif can be moved again.



- > Select an embroidery motif.
- > Tap «Embroidery».



- > Tap «Move Hoop».
- > Turn the «Upper Multi-function knob» to move the embroidery motif horizontally.
- > Turn the «Lower Multi-function knob» to move the embroidery motif vertically.



- > To accept the settings, tap «Embroidery» in the Process Navigation.

Embroidery sequence control when thread breaks

If the thread breaks, the needle can be repositioned in the embroidery motif using the function Embroidery Sequence Control.



- > Select an embroidery motif.
- > Tap «Embroidery».



- > Tap «Embroidery Sequence Control».
 - In the left section of the display a compact view of the embroidery motif is displayed. On the right side the enlarged embroidery motif is displayed.
- > Select the desired position in the compact view.
- > Turn the «Upper Multi-function knob» to move the hoop stitch by stitch.
- > Turn the «Lower Multi-function knob» to move the hoop in large steps.
 - The number in the yellow-outlined icon indicates the number of stitches within the embroidery sequence.



- > To select the desired stitch by entry, tap the icon «Stitch Position via number».

Cutting connecting stitches

The function is activated by default and the connecting stitches are cut automatically. When the function is deactivated, the connecting stitches between the embroidery motifs must be cut manually.



- > Select an embroidery motif.
- > Tap «Embroidery».



- > To deactivate the function, tap the yellow-outlined icon «Cut Connecting Stitches».
- > To activate the function, tap the yellow-outlined icon «Cut Connecting Stitches» again.

Reducing color changes

When the embroidery motifs overlap, the color changes **cannot** be reduced.

- > Select an embroidery motif.



- > Tap «Embroidery».



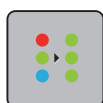
- > Tap «Reduce Color Changes».
 - Identical colors of the embroidery motif are collected to one color.

Multi-colored embroidery motif on/off

Multi-colored embroidery motifs can also be embroidered in one color.



- > Select an embroidery motif.
- > Tap «Embroidery».



- > Tap «Multi-colored Embroidery Motif On/Off».
 - The embroidery motif is embroidered in one color.

Color indication

Every color of the embroidery motif can be selected individually. The hoop moves to the first stitch of the current color. The currently active color can be embroidered individually or in another sequence.



- > Select an embroidery motif.
- > Tap «Embroidery».
- > Touch the icon Scroll up to select the previous color of the embroidery motif.

15.11 Freearm Embroidery

Freearm embroidering is defined as embroidering tubular fabrics or garments which are positioned around the freearm of the embroidery machine while being embroidered. Often used for sleeves, trouser legs or other narrow-tailored garments.



A fabric tube can be comfortably placed around the freearm of the machine if the embroidery hoop is moved to the left into the park position before attaching or removing it. To bring the hoop back into embroidery position afterwards, push the button «Start/Stop».

If possible, use a full bobbin as the embroidery hoop must be removed when the bobbin is changed.

Borders can be closed easily and exactly along the edge of the tube to form a ring.

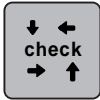
The mobility of the embroidery arm can be restricted or impeded with very narrow fabric tubes. Therefore make sure that the embroidery hoop can move forwards and backwards sufficiently. An impediment of the embroidery arm caused by a fabric tube which is too tight can result in embroidery motif offset or damage to the fabric.

Check the movability of the freearm

Note: If the fabric tube is narrow, deactivate the Thread Away Mode in the Setup Program.

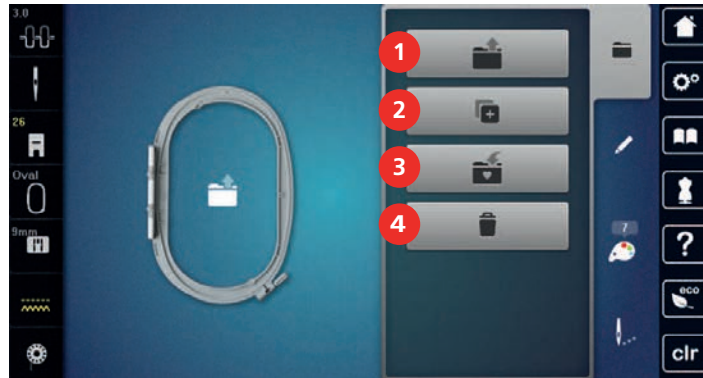
- > Open the embroidery motif on the machine and edit as desired.
- > Mark the embroidery motif position and the size on the fabric in a suitable way.
- > Select the embroidery hoop as small as possible.
- > Hoop or stick the fabric along with the appropriate stabilizer in the embroidery hoop, depending on the stabilizer.

- > Pull the fabric tube carefully over the freearm of the machine and attach the embroidery hoop at the clutch of the embroidery module.
- > If necessary, reposition the embroidery motif.
- > Tap «Check Embroidery Motif Size».
- > After the successful check of the embroidery motif size, start the embroidery process.



15.12 Administering embroidery motifs

Administering embroidery motifs



- | | | | |
|---|-------------------------|---|---------------------------|
| 1 | «Load Embroidery Motif» | 3 | «Save Embroidery Motif» |
| 2 | «Add Embroidery Motif» | 4 | «Delete Embroidery Motif» |

Saving embroidery motifs in the personal memory

In the file «Save Embroidery Motifs» any embroidery motifs including individually edited embroidery motifs can be saved.

- > Select an embroidery motif.
- > Edit the embroidery motif.
- > Tap «Selection».



- > Tap «Save Embroidery Motif».
 - The embroidery motif to be saved is outlined in yellow.
 - The «Embroidery machine» is activated.



- > Tap «Confirm».

Saving the embroidery motif on the BERNINA USB stick

- > Select an embroidery motif.
- > Edit the embroidery motif.
- > Tap «Selection».



- > Tap «Save Embroidery Motif».
 - The embroidery motif to be saved is outlined in yellow.
- > Insert the BERNINA USB stick into the USB port of the machine.

 > Tap «USB Stick».

 > Tap «Confirm».

Overwriting the embroidery motif in the personal memory

> Select an embroidery motif.

> Edit the embroidery motif.

> Tap «Selection».



 > Tap «Save Embroidery Motif».

– The embroidery motif to be saved is outlined in yellow.

 – The «Embroidery machine» is activated.

> Select the embroidery motif which is to be overwritten.

 > Tap «Confirm».

Overwriting the embroidery motif on the BERNINA USB stick

> Select an embroidery motif.

> Edit the embroidery motif.

> Tap «Selection».



 > Tap «Save Embroidery Motif».

– The embroidery motif to be saved is outlined in yellow.

> Insert the BERNINA USB stick into the USB port of the machine.

 > Tap «USB Stick».

> Select the embroidery motif which is to be overwritten.

 > Tap «Confirm».

Importing stitch patterns

Stitch patterns or stitch pattern combinations can be imported from the Sewing Mode to the Embroidery Mode and edited like embroidery motifs. Therefore endless embroidery can be combined quickly and easily and saved as an embroidery motif in the file «Personal embroidery motifs».



> Tap «Home».



> Tap «Sewing Mode».

> Select a stitch pattern.



> Tap «Home».

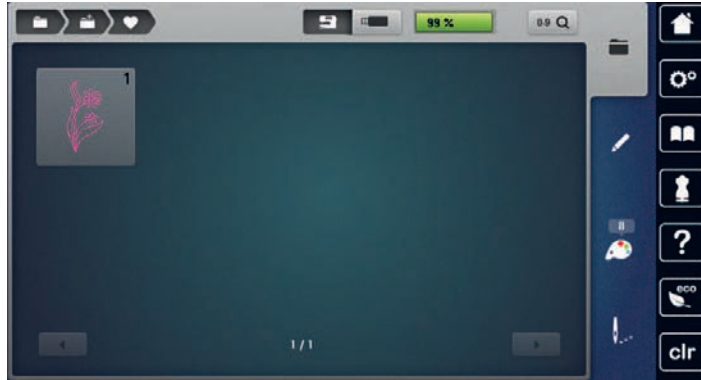


> Tap «Embroidery Mode».

– The stitch pattern is automatically stored in the folder «Personal Embroidery motif».



- > Select «Personal Embroidery motif».
- > Select an embroidery motif.



Loading an embroidery motif from the personal memory



- > Tap «Selection».



- > Tap «Load Embroidery Motif».



- > Select «Personal Embroidery motif».
- > Select an embroidery motif.

Loading an embroidery motif from the BERNINA USB stick



- > Tap «Selection».
- > Insert the BERNINA USB stick into the USB port of the machine.



- > Tap «USB Stick».
- > Select a personal embroidery motif.

Deleting an embroidery motif from the personal memory

The embroidery motifs which are saved in the personal memory can be deleted individually.



- > Tap «Selection».



- > Tap «Delete».



- The «Embroidery machine» is activated.

- > Select the embroidery motif which is to be deleted.



- > Tap «Confirm».

Deleting an embroidery motif from the BERNINA USB stick



> Tap «Selection».



> Tap «Delete».

> Insert the BERNINA USB stick into the USB port of the machine.



> Tap «USB Stick».

> Select the embroidery motif which is to be deleted.



> Tap «Confirm».



16 Embroidery

16.1 Embroidering via the button «Start/Stop»

In case of a power cut the embroidery process is interrupted. After the restart the machine goes to the position which was embroidered last.



- > Push the button «Start/Stop» until the embroidery machine starts.
 - All parts of the motif being in the current color are embroidered.
 - The embroidery machine stops automatically at the end.
 - Both threads are cut automatically.
 - The embroidery machine switches to the next color automatically.



- > Change the upper thread.
- > To embroider the new color, push the button «Start/Stop».
 - After finishing the embroidery motif, the machine stops automatically and the threads are cut automatically.

16.2 Increasing the embroidery speed

To ensure the best embroidery quality, the speed when embroidering is reduced depending on the embroidery position. Choose between the two options to either embroider at optimal or maximum speed. Standard = optimal speed. It has to be considered that the quality of the embroidered embroidery motif at maximum speed cannot be ensured.

By switching the machine off and on, the optimal embroidery speed is activated.

Prerequisite:

- The embroidery motif is selected.



- > Tap «Embroidery speed».
 - The maximum speed is activated.
- > Tap «Embroidery speed» again.
 - The optimal speed is activated.

16.3 Adjusting the upper thread tension

The default setting of the upper thread tension is set automatically as soon as a stitch pattern or an embroidery motif is selected.

When of using other types of sewing or embroidery threads, the optimal tension may vary. Therefore it may be necessary to adjust the upper thread tension according to the sewing or embroidering project as well as the desired stitch pattern or the embroidery motif individually.

The higher the upper thread tension, the tighter the upper thread which means that the bobbin thread is pulled up to the top of the fabric. When the upper thread tension is low, the upper thread is less tightened which means that the bobbin thread is pulled up less.

Alteration of the upper thread tension affect the currently selected stitch pattern and all embroidery motifs. Permanent alterations of the upper thread tension for the Sewing Mode (see page 51) and for the Embroidering Mode (see page 55) can be made in the Setup Program.



- > Tap «Upper Thread Tension».

- > Adjust the upper thread tension.



- > Tap the yellow-outlined icon on the right side to reset the alterations to the default setting.
- > Tap the yellow-outlined icon on the left side to reset the alteration to default setting in the **Setup Program**.

16.4 Embroidering via the foot control

Embroidering via the foot control is recommended when only a short sequence has to be embroidered. While embroidering, the foot control must be pressed down all the time.

- > Press the foot control to start embroidering.

17 Care and maintenance

17.1 Firmware

Checking the firmware version

The firmware and hardware versions of the machine and the connected embroidery module are displayed.



> Tap «Setup Program».



> Tap «Machine Settings».



> Tap «Information».



> Tap «Machine Data».

Updating firmware

The latest firmware of the machine and a detailed step-by-step instruction for updating processes can be downloaded at www.bernina.com. In general, personal data and settings are automatically transferred during a firmware update. For reasons of safety, it is also recommended to save data and settings on a BERNINA USB stick before the firmware update is started. If personal data and settings should get lost during a firmware update, they can be transferred to the machine again afterwards.

> Insert the USB stick with the new firmware version into the machine.

> Tap «Setup Program».



> Tap «Machine Settings».



> Tap «Maintenance/Updates».



> Tap «Machine Update».



> Tap «Save Data».

– When the data is saved, a green tick is temporarily displayed.

NOTICE

The BERNINA USB stick (optional accessory) has been removed too early

Firmware has not been updated and the machine cannot be used.

> Remove the BERNINA USB stick (optional accessory) only after the update has been completed successfully.

- Update** > To start the firmware update, tap «Update».
Note: The update may take several minutes. Do not switch off the machine or remove the USB stick during the update.
 - The machine restarts. When the update is complete, a message appears.

Recovering saved data

If personal data and settings after a software update are not available anymore, they can be transferred to the machine again afterwards.



- > Insert the BERNINA USB stick providing the saved data and settings into the USB port of the machine.
- > Tap «Setup Program».



- > Tap «Machine Settings».



- > Tap «Maintenance/Updates».



- > Tap «Machine Update».

NOTICE

The BERNINA USB stick (optional accessory) has been removed too early
 Saved data cannot be transferred and the machine cannot be used.

- > Remove the BERNINA USB stick (optional accessory) only after the saved data has been transferred successfully.



- > Tap «Load Data».
 – After the data has been transferred, a green tick is temporarily displayed.

17.2 Machine

Cleaning the display

- > Clean the display in the switched off status with a soft slightly damp microfiber cloth.

Cleaning the feed dog

Remaining threads under the stitch plate must occasionally be removed.

- > Raise the needle and presser foot.

CAUTION

Electronically driven components

Risk of injury near the needle and the hook.

- > Switch the machine off and disconnect it from the power supply system.

- > Remove the needle and presser foot.

- > Lower feed dog.



- > Remove the stitch plate.

NOTICE

Dust and thread residues inside the machine

Damage to mechanical and electronic components.

- > Use a brush or a soft cloth.
- > Do not use compressed air spray.

- > Clean the feed dog with the brush.

Cleaning the hook

CAUTION

Electronically driven components

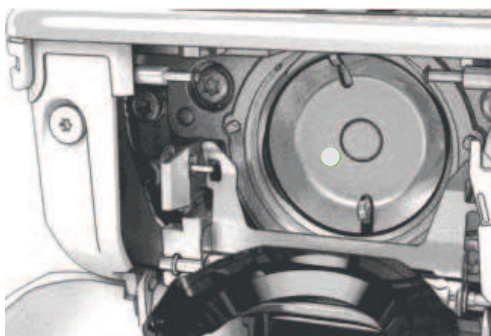
Risk of injury near the needle and the hook.

- > Switch the machine off and disconnect it from the power supply system.

- > Open the hook cover.
- > Remove the bobbin case.
- > Press the release lever to the left.



- > Fold down the fastening bracket along with the black hook race cover.
- > Remove the hook.



NOTICE

Dust and thread residues inside the machine

Damage to mechanical and electronic components.

- > Use a brush or a soft cloth.
- > Do not use compressed air spray.

- > Clean the hook race with a brush and a soft cloth. Do not use any sharp objects.
- > Hold the hook at the pin in the center with two fingers.
- > Guide the hook, lower edge first, at an angle from above behind the hook race cover.
- > Position the hook with the two lugs on the hook driver meeting the corresponding openings in the hook; the colored mark on the hook driver should be visible through the hole in the hook.
- > Insert the hook.
 - The hook is magnetic and therefore fastened to the correct position.
- > Close the hook race cover and the fastening bracket until the release bracket engages.
- > As a check, turn the handwheel.
- > Insert the bobbin case.

Lubricating the hook

Lubricating the hook can prevent the occurrence of unwanted noises in the hook area. BERNINA recommends lubricating the hook in the following cases:

- Before using the machine for the first time
- After a longer downtime of the machine
- For intensive use: daily before sewing
- When the message " Lubricate the machine " is displayed
- In case of unwanted noises in the hook area

 CAUTION

Electronically driven components

Risk of injury near the needle and the hook.

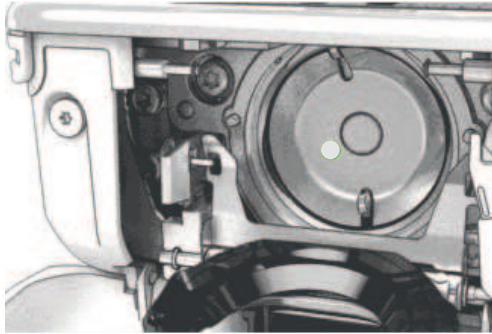
- > Switch the machine off and disconnect it from the power supply system.

- > Remove the bobbin case.
- > Press the release lever to the left.



- > Fold down the fastening bracket along with the black hook race cover.

- > Remove the hook.



- > Clean the hook race with a brush and a soft cloth. Do not use any sharp objects.
- > Add one drop of BERNINA oil down into the hook race.



- > Add one drop of oil into each of the two oil depots so that the felts are damp, and make sure that the red-marked surface of the hook sleeve remains free of oil.



- > Hold the hook at the pin in the center with two fingers.
- > Guide the hook, lower edge first, at an angle from above behind the hook race cover.
- > Position the hook with the two lugs on the hook driver meeting the corresponding openings in the hook; the colored mark on the hook driver should be visible through the hole in the hook.
- > Insert the hook.
 - The hook is magnetic and therefore fastened to the correct position.
- > Close the hook race cover and the fastening bracket until the release bracket engages.
- > As a check, turn the handwheel.
- > Insert the bobbin case.
- > Sew or embroider on a test fabric.

Cleaning the thread catcher



> Tap «Setup Program».



> Tap «Machine Settings».



> Tap «Maintenance/Updates».

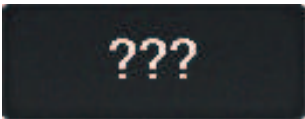


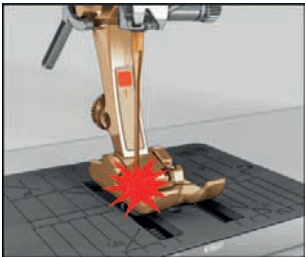






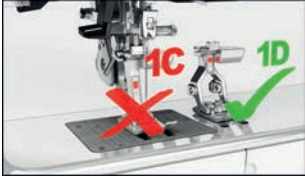
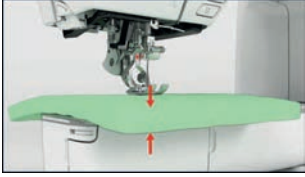
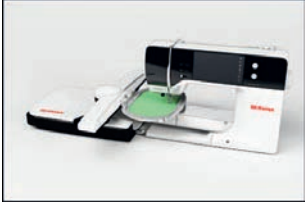
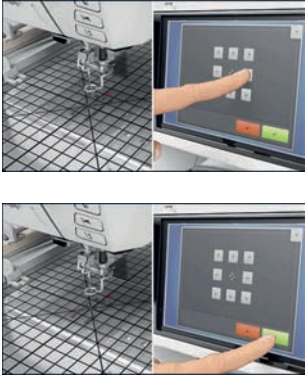

> Tap «Cleaning the thread catcher».

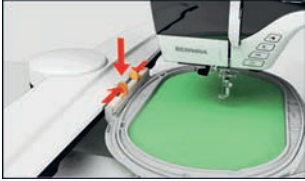
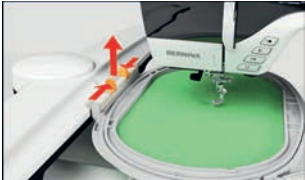
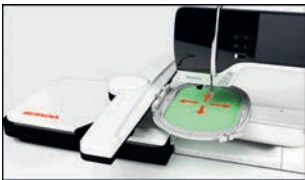


> Clean the thread catcher according to the instructions on the display.


18 Errors and faults


18.1 Error messages

Message on the display	Cause	Solution
	Stitch number unknown.	> Check the entry and enter the new number.
	The stitch pattern cannot be selected in the Combi-mode.	> Combine other stitches.
	The feed dog is not lowered.	> To lower the feed dog, push the button «Feed dog up/down».
	The selected needle and stitch plate cannot be used in combination.	> Replace the needle. > Replace the stitch plate.
	The needle is not at its top end.	> Adjust the needle position via the handwheel.
	The upper thread is used up.	> Rethread.
	The upper thread has broken.	> Rethread.
	The bobbin thread is used up.	> Rethread.
	The bobbin thread has broken.	> Clean the hook. > Rethread.

Message on the display	Cause	Solution
	The main motor is not running.	<ul style="list-style-type: none"> > Turn the handwheel clockwise until the needle is at its top position. > Remove the sewing project. Do not pull on the fabric or the thread. > Remove the stitch plate. > Remove the thread remnants. > Clean the hook. > Remove the hook and make sure that there are no pieces of broken needle points on the magnetic back of the hook. > Deactivate the thread catcher in the Setup Program.
	Incorrect presser foot for the BERNINA Dual Feed.	<ul style="list-style-type: none"> > Fit a presser foot with the designation «D».
	The fabric under the presser foot is too thick.	<ul style="list-style-type: none"> > Reduce the fabric thickness.
	The contact between the machine and the embroidery module is interrupted due to vibrations.	<ul style="list-style-type: none"> > Make sure that the module and the machine are standing on a stable, even surface. > Connect the embroidery module to the machine.
	The needle position doesn't correspond with the center of the hoop.	<ul style="list-style-type: none"> > Calibrate the hoop.
	The embroidery module is not attached.	<ul style="list-style-type: none"> > Connect the embroidery module to the machine. > Contact the specialized BERNINA dealer to have the machine checked.

Message on the display	Cause	Solution
	The hoop is not attached.	> Attach the hoop.
	The hoop is attached.	> Remove the embroidery hoop.
	The movement of the hoop follows.	> Tap «Confirm».
	The embroidery motif is partly outside the hoop.	> Reposition the embroidery motif and start embroidering it again.
	The embroidery motif is too large.	> Reduce the size of the embroidery motif. > Attach a larger hoop.
Insufficient free space on the BERNINA USB stick (optional accessory).	There is not enough free capacity on the BERNINA USB stick (optional accessory).	> Make sure that the BERNINA USB stick (optional accessory) is used. > Delete data from the BERNINA USB stick (optional accessory).
No personal data on the BERNINA USB stick (optional accessory).	No personal data for recovery available on the BERNINA USB stick (optional accessory).	> Make sure that the data and settings have been saved on the BERNINA USB stick (optional accessory).
The recovery of personal data has failed.	The firmware update has been successful but the personal data could not be recovered.	> Make sure that the data and settings have been saved on the BERNINA USB stick (optional accessory). > Transfer saved data to the machine.


Message on the display	Cause	Solution
No BERNINA USB stick is inserted. Make sure that during the complete automatic update always the same BERNINA USB stick remains inserted.	The BERNINA USB stick (optional accessory) is not inserted.	<ul style="list-style-type: none"> > Use a BERNINA USB stick (optional accessory) providing enough free capacity.
The firmware update has failed.	The latest firmware version cannot be found on the USB stick.	<ul style="list-style-type: none"> > Make sure that the compressed zip file has been unzipped for the firmware update. > Check whether the data for the software update is saved directly on the data medium and not in a file on the USB stick. > Updating Firmware.
	The machine needs cleaning/ lubricating.	<ul style="list-style-type: none"> > Clean the machine. > Lubricate the machine. <p>Important information on lubricating:</p> <ul style="list-style-type: none"> > Too much oil may stain the fabric and the thread. > After lubricating, sew/embroider a test piece first.
The automatic thread cutter (at the thread catcher) needs cleaning.	The thread catcher must be cleaned. The message appears every time the machine is switched on after 1000 cutting cycles have been reached.	<ul style="list-style-type: none"> > Tap «Confirm». <ul style="list-style-type: none"> – The machine calls up the function «Clean the thread catcher». > Clean the thread catcher according to the instructions on the display. <ul style="list-style-type: none"> – The counter for the cutting cycles is reset.
It is time for the regular maintenance. Please contact your specialized BERNINA dealer to make an appointment.	<p>The machine needs maintenance. The message appears after the programmed service interval has expired.</p> <p>Important information: Having your machine cleaned and serviced properly at the appropriate times ensures its proper functioning and a long service life. Failure to do so may adversely affect service life and limit the guarantee. The charge for servicing is nationally regulated – consult your dealer or servicing shop for more details.</p>	<ul style="list-style-type: none"> > Contact a specialized BERNINA dealer. > Delete the message temporarily by touching the icon «ESC». <p>When you clear the message three times, it will not be displayed until the next service interval is reached.</p>

Message on the display	Cause	Solution
	<p>The calibration of the Buttonhole foot with slide #3A has failed.</p>	<ul style="list-style-type: none"> > Check the presser foot for ease of movement. If necessary, remove lint, dust and fabric remnants. > Clean the reflector with a soft, slightly damp microfiber cloth. > Check the position of the reflector. If necessary, correct the position of the reflector or replace the presser foot. > Check the plastic on the underside of the presser foot for signs of wear. Replace the presser foot if necessary. > Clean the feed dog. > If the error still occurs, contact specialized BERNINA dealer.

18.2 Troubleshooting

Fault	Cause	Solution
Uneven stitch formation	Upper thread too tight or too loose.	<ul style="list-style-type: none"> > Adjust the upper thread tension. > Check the thread feed from the thread spool.
	Needle blunt or bent.	> Replace the needle, make sure that a new BERNINA quality needle is used.
	Poor quality needle.	> Use a new BERNINA quality needle.
	Poor quality thread.	> Use quality thread.
	Incorrect needle/thread combination.	> Match the needle with the thread size.
	Incorrectly threaded.	> Rethread.
	Fabric has been pulled.	> Feed the fabric evenly.
Uneven stitch formation	Incorrect bobbin case is used.	> Use the supplied bobbin case marked with the triangle.



Fault	Cause	Solution
Skipped stitches	Incorrect needle.	> Use the needle system 130/705H.
	Needle blunt or bent.	> Replace the needle.
	Poor quality needle.	> Use a new BERNINA quality needle.
	The needle is incorrectly inserted.	> Insert the needle with the flat side to the back as far up as it will go into the needle holder and tighten the screw.
	Incorrect needle point.	> Match the needle point to the texture of the material.
Faulty stitching	Thread remnants between the thread tension discs.	> Fold a piece of thin material and slide the folded edge (not the raw edges) between the thread tension discs.
	Incorrectly threaded.	> Rethread.
	Thread remnants below the bobbin case spring.	> Remove the thread remnants under the spring.
Upper thread breaks	Incorrect needle/thread combination.	> Match the needle with the thread size.
	Upper thread is too tight.	> Reduce the upper thread tension.
	Incorrectly threaded.	> Rethread.
	Poor quality thread.	> Use quality thread.
	The stitch plate or the hook tip is damaged.	> Contact the nearest specialized BERNINA dealer to have the damages repaired. > Replace the stitch plate.
	The thread is caught in the area of the thread take-up lever.	> Remove the screw (1) on the headframe with the angular Torx Screwdriver. > Pull the headframe at the bottom slightly forward. > Flip the headframe upwards a bit and remove it. > Remove the thread remnants. > Attach the headframe and tighten the screw.
		
Lower thread breaks	The bobbin case is damaged.	> Replace the bobbin case.
	The stitch hole in the stitch plate is damaged.	> Contact the nearest specialized BERNINA dealer to have the damages repaired. > Replace the stitch plate.
	Needle blunt or bent.	> Replace the needle.

Fault	Cause	Solution
Needle breaks	The needle is incorrectly inserted.	> Insert the needle with the flat side to the back as far up as it will go into the needle holder and tighten the screw.
	Fabric has been pulled.	> Feed the fabric evenly.
	Thick fabric has been pushed.	> Use a suitable presser foot, e. g. Jeans Foot #8, for thick fabric. > Use the height compensating tool when sewing over a thick seam.
	Knotted thread.	> Use quality thread.
Display is inactive	Incorrect calibrating data.	> Recalibrate the display. (see page 62)
	The eco Mode is active.	> Tap «eco Mode».
Stitch width not adjustable	The selected needle and stitch plate cannot be used in combination.	> Replace the needle. > Replace the stitch plate.
	The «Presser foot indicator / presser foot selection» prevents the adjustment of the stitch width.	> Select the fitted presser foot.
Speed too low	Unfavorable room temperature.	> Place the machine in a warm room one hour before use.
	Settings in the Setup Program.	> Adjust the sewing speed in the Setup Program. > Adjust the slide.
The machine doesn't start	Unfavorable room temperature.	> Place the machine in a warm room one hour before use. > Connect the machine and switch it on.
	The machine is damaged.	> Contact a specialized BERNINA dealer.
The light of the button «Start-/Stop» doesn't light up	Light is defect.	> Contact a specialized BERNINA dealer.
Neither the sewing light nor the light on the frearm lights up	Settings in the Setup Program.	> Activate it in the Setup Program.
	The sewing light is defect.	> Contact a specialized BERNINA dealer.
Upper thread monitor doesn't react	Settings in the Setup Program.	> Activate it in the Setup Program.
	The upper thread indicator is defect.	> Contact a specialized BERNINA dealer.

Fault	Cause	Solution
Bobbin thread monitor doesn't react	Settings in the Setup Program.	> Activate it in the Setup Program.
	The bobbin thread indicator is defect.	> Contact a specialized BERNINA dealer.
Error during firmware update	USB stick is not recognized.	> Using the BERNINA USB stick.
	The update process is blocked and the hourglass on the display is inactive.	> Remove the USB stick. > Switch off the machine. > Switch the machine on. > Follow the instruction on the display.
	Firmware update files are not found.	> Unzip the update data. > Store data for the firmware update directly on the data medium and not in a folder on the USB stick.
Beads and/or bartacks are repeatedly not sewn properly	The Buttonhole foot with slide #3A is not calibrated with the machine.	> Calibrate Buttonhole foot with slide #3A. (see page 63)

19 Storage and disposal

19.1 Storing the machine

It is recommended to store the machine in the original packaging. If the machine is stored in a cold room, place it in a warm room one hour before use.

- > Switch the machine off and disconnect it from the power supply system.
- > Don't store the machine outdoor.
- > Protect the machine against climatic influences.

19.2 Dispose of the machine

- > Clean the machine.
- > Sort the components by their materials and dispose of them according to the local laws and regulations.

20 Technical data

Designation	Value	Unit
Maximum fabric thickness	12.5 (0.49)	mm (in)
Sewing light	30	LED
Maximum speed	1000	Stitches per minute
Measurements without the spool pin (W × H × D)	522 × 358 × 214 (20.55 × 14.09 × 8.43)	mm (in)
Weight	14 (30.86)	kg (lb)
Energy consumption	140	W
Input voltage	100 – 240	V
Protection class (Electrical engineering)	II	

21 Overview stitch patterns

21.1 Overview Stitch patterns

Practical stitches

1	2	3	4	5	6	7	8	9	10	11	12	13	14
15	16	17	18	19	20	21	22	23	24	25	26	27	29
31	32	33	34	35	36	37	38	39	40				

Buttonholes

51	52	53	54	55	56	57	58	59	60	61	62	63	64
65	67	68	69	70									

Decorative stitches

Natural stitches

101	102	103	104	105	106	107	108	109	110	111	112	113	114
115	116	117	118	119	122	123	124	125	126	127	128	129	130
131	132	134	136	137	138	139	140	141	142	143	144	145	146
147	148	150	152	153	154	155	156	159	160	161	165	166	167
168	169	170	171	172	173	174	175	176	177	178	179	180	181

Overview stitch patterns

182 	183 	184 	185
---------	---------	---------	---------

Cross stitches

301 	302 	303 	304 	305 	306 	307 	308 	309 	311 	313 	314 	319 	320
321 	322 	323 	324 	325 	326 	327 	328 	329 	330 	331 	332 	333 	334
335 	336 	337 	338 	339 	371 	372 	373 	374 	375 	376 	377 	378 	

Satin stitches

401 	402 	405 	406 	407 	408 	409 	410 	412 	413 	414 	415 	416 	417
418 	419 	421 	422 	423 	424 	425 	426 	427 	428 	429 	430 	431 	433
434 	436 	437 	440 	442 	443 	444 	445 	447 	448 	449 	450 	451 	452
453 	454 	455 	456 	457 	458 	461 	464 	465 	466 	468 	469 	471 	472
473 													

Geometric stitches

601 	602 	603 	604 	605 	606 	607 	608 	609 	610 	611 	612 	613 	614
615 	616 	618 	619 	620 	621 	622 	623 	624 	625 	626 	627 	628 	629

630	631	632	633	634	635	636	637	639	640	641	642	643	644
645	646	647	648	649	650	651	652	653	654	655	656	657	658
660	661	662	663	664	665	666	674	675	676	677	678	679	680
682	683	684	685	686	691	694							

White embroidery

701	702	703	704	705	706	707	708	709	710	711	712	713	714
715	716	717	721	722	723	724	725	726	727	729	730	731	732
733	734	735	736	737	738	739	740	741	742	743	744	745	746
747	748	749	750	751	752	756	762	764	765	767	768	769	770
771	772	773	774	775	776	777	778	779	780	781	782	783	

Novelty stitches

901	902	903	904	905	906	907	908	909	910	911	912	913	914
915	916	917	918	919	920	921	922	924	926	928	929	935	937
938	939	940	944	945	946	948	949	950	952	954	955	957	958

Overview stitch patterns

959	960	961	962

International

1701	1702	1703	1704	1705	1706	1707	1708	1709	1710	1711	1715	1716	1717
1718	1719	1720	1721	1722	1723	1729	1730	1731	1732	1733	1735	1736	

Seasons

2001	2002	2003	2004	2005	2006	2007	2008	2009	2015	2016	2017	2018	2019
2020	2021	2022	2023										

Sport and hobbies

2201	2202	2203	2204	2205	2206	2207	2209	2210	2211	2212	2213	2215	2216
2217	2218	2219											

Quilt stitches

1301	1302	1303	1304	1305	1306	1307	1308	1309	1310	1311	1312	1313	1314
1315	1316	1317	1318	1319	1320	1321	1322	1323	1324	1325	1326	1327	1329
1330	1331	1332	1333	1334	1335	1336	1337	1338	1339	1340	1341	1342	1343
1344	1345	1346	1363	1364	1365	1366	1367	1368	1369	1370	1371	1373	1374

1375	1376	1377	1378	1379	1380	1381	1382	1384	1385	1386	1387	1388	1389
1390	1391	1393	1394										

21.2 Overview Embroidery motifs

Editing embroidery motifs

Let your inspiration run free. A vast selection of embroidery motifs is at your disposal.

If you see one of the following pictograms below a number of the embroidery motif, you can find additional information at <https://www.bernina.com/specialeffects>.

	Detached point		Punchwork Design (motif)
	Basic CutWork		Couching
	Fringe		Projects in the hoop
	Appliqué		Puffy Fonts
	CutWork Design (motif)		Quilting
	PaintWork Design (motif)		Trapunto
	CrystalWork Design (motif)		

Quilt motifs

Bd380	103 x 103 mm 4 x 4.1 inch	2.976	Bd378	64 x 64 mm 2.5 x 2.5 inch	820
--------------	------------------------------	-------	--------------	------------------------------	-----

1. Isacord 40 5822



1. Isacord 40 5822



Bd379 	 96 x 96 mm 3.8 x 3.8 inch	 1.639	Bd381 	 62 x 64 mm 2.4 x 2.5 inch	 866
1.  Isacord 40 5822			1.  Isacord 40 5822		
					
Bd382 	 80 x 69 mm 3.2 x 2.7 inch	 756	Bd383 	 80 x 80 mm 3.1 x 3.1 inch	 1.690
1.  Isacord 40 5822			1.  Isacord 40 5822		
					
Bd384 	 46 x 46 mm 1.8 x 1.8 inch	 430	Bd385 	 46 x 92 mm 1.8 x 3.6 inch	 852
1.  Isacord 40 5822			1.  Isacord 40 5822		
					
Bd386 	 93 x 91 mm 3.6 x 3.6 inch	 1.572	Bd387 	 67 x 67 mm 2.6 x 2.6 inch	 741
1.  Isacord 40 5822			1.  Isacord 40 5822		
					
Bd388 	 101 x 33 mm 4 x 1.3 inch	 661	Bd389 	 101 x 36 mm 4 x 1.4 inch	 837
1.  Isacord 40 5822			1.  Isacord 40 5822		
					

Bd390 101 x 32 mm 4 x 1.2 inch 925

1. Isacord 40 5822



Bd391 43 x 55 mm 1.7 x 2.2 inch 620

1. Isacord 40 5822



Bd392 52 x 68 mm 2.1 x 2.7 inch 632

1. Isacord 40 5822



Bd395_48 96 x 96 mm 3.8 x 3.8 inch 5.672

1. Isacord 40 3641



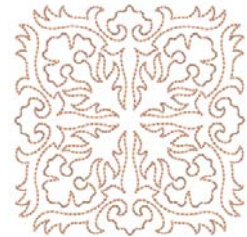
Bd396_48 97 x 97 mm 3.8 x 3.8 inch 3.728

1. Isacord 40 3641



Bd403_48 97 x 97 mm 3.8 x 3.8 inch 5.309

1. Isacord 40 1430



Bd407_48 51 x 41 mm 2 x 1.6 inch 974

1. Isacord 40 1335



Bd408_48 80 x 80 mm 3.1 x 3.1 inch 2.468

1. Isacord 40 1335



Bd409_48 55 x 74 mm 2.2 x 2.9 inch 1.838






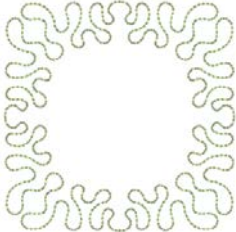

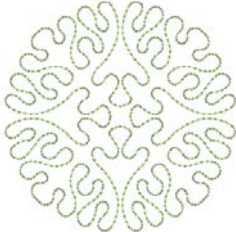





















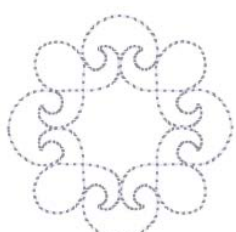










1. Isacord 40 1335




Bd410_48 75 x 75 mm 2.9 x 2.9 inch 2.555

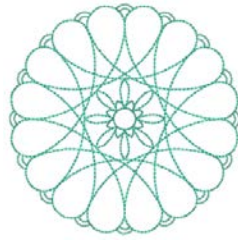
1. Isacord 40 1335



<p>Bd414_48  97 x 97 mm 3.8 x 3.8 inch  2.738</p>	<p>Bd415_48  97 x 97 mm 3.8 x 3.8 inch  3.212</p>
<p>1.  Isacord 40 5822</p> 	<p>1.  Isacord 40 5822</p> 
<p>Bd416_48  97 x 97 mm 3.8 x 3.8 inch  2.168</p>	<p>Bd364  89 x 89 mm 3.5 x 3.5 inch  1.373</p>
<p>1.  Isacord 40 5822</p> 	<p>1.  Isacord 40 3150</p> 
<p>Bd370  46 x 93 mm 1.8 x 3.7 inch  1.028</p>	<p>Bd373  103 x 34 mm 4 x 1.3 inch  770</p>
<p>1.  Isacord 40 3150</p> 	<p>1.  Isacord 40 3150</p> 
<p>Bd367  65 x 65 mm 2.6 x 2.6 inch  1.124</p>	<p>Bd566_48  110 x 59 mm 4.3 x 2.3 inch  2.260</p>
<p>1.  Isacord 40 3150</p> 	<p>1.  Isacord 40 5531</p> 
<p>Bd565_48  99 x 99 mm 3.9 x 3.9 inch  4.424</p>	<p>Bd558_48  104 x 104 mm 4.1 x 4.1 inch  4.472</p>
<p>1.  Isacord 40 5531</p> 	<p>1.  Isacord 40 4620</p> 

 **12499-06**  102 x 102 mm  3.838

1.  Isacord 40 5115




 **12499-04**  123 x 123 mm  7.229

1.  Isacord 40 5610



 **12499-05**  123 x 123 mm  6.317

1.  Isacord 40 4103




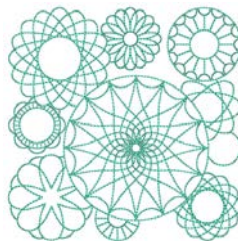
 **12499-24**  133 x 215 mm  11.445

1.  Isacord 40 4103



 **12499-23**  123 x 123 mm  11.194

1.  Isacord 40 5115




 **12607-20**  122 x 122 mm  1.055

1.  Isacord 40 0020



 **12607-21**  61 x 122 mm  657

1.  Isacord 40 0020




 **12416-04**  89 x 89 mm  3.482

1.  Isacord 40 0721



 **12416-03**  124 x 124 mm  5.909

1.  Isacord 40 0721








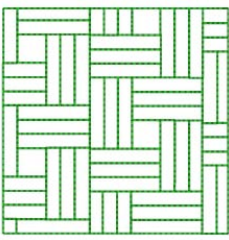





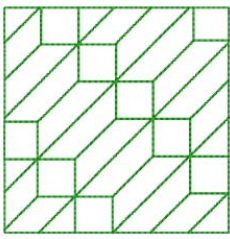

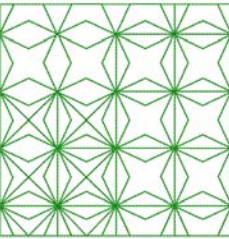





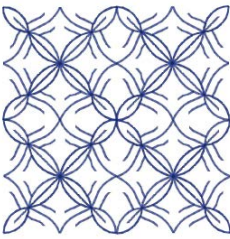

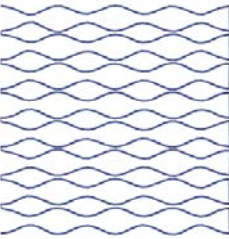





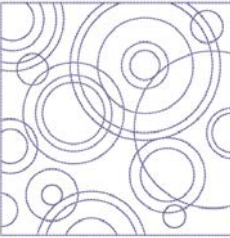







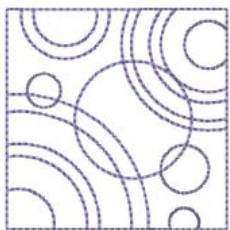




 **12416-26**  44 x 174 mm  2.816

1.  Isacord 40 3830




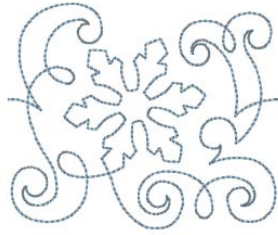
Overview stitch patterns

<p>12416-48  171 x 178 mm 6.7 x 7 inch  9.050</p>	<p>Nb346_48  76 x 76 mm 3 x 3 inch  3.366</p>
<p>1.  Isacord 40 5610</p> 	<p>1.  Isacord 40 5513</p> 
<p>Nb347_48  76 x 76 mm 3 x 3 inch  2.337</p>	<p>Nb334_48  127 x 127 mm 5 x 5 inch  6.838</p>
<p>1.  Isacord 40 5513</p> 	<p>1.  Isacord 40 5513</p> 
<p>Nz498  89 x 89 mm 3.5 x 3.5 inch  2.642</p>	<p>Nz503  99 x 99 mm 3.9 x 3.9 inch  2.103</p>
<p>1.  Isacord 40 3353</p> 	<p>1.  Isacord 40 3353</p> 
<p>82013-29  121 x 121 mm 4.8 x 4.8 inch  5.644</p>	<p>82013-30  83 x 166 mm 3.3 x 6.5 inch  2.774</p>
<p>1.  Isacord 40 2920</p> 	<p>1.  Isacord 40 2920</p> 
<p>82013-31  57 x 58 mm 2.3 x 2.3 inch  1.884</p>	<p>82013-32  122 x 105 mm 4.8 x 4.1 inch  4.506</p>
<p>1.  Isacord 40 2920</p> 	<p>1.  Isacord 40 2920</p> 



12416-24  89 x 73 mm
3.5 x 2.9 inch  2.330

1.  Isacord 40 3830




12607-16  123 x 122 mm
4.8 x 4.8 inch  1.222

1.  Isacord 40 0020



12616-16  123 x 123 mm
4.8 x 4.8 inch  1.198

1.  Isacord 40 5422



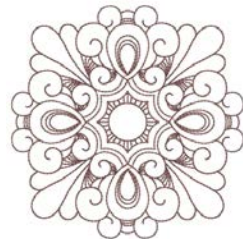
12380-22  110 x 61 mm
4.4 x 2.4 inch  2.487

1.  Isacord 40 1543



12380-43  123 x 123 mm
4.9 x 4.9 inch  8.248


1.  Isacord 40 1543



12380-30  89 x 96 mm
3.5 x 3.8 inch  4.442



1.  Isacord 40 1543



12380-04  83 x 90 mm
3.3 x 3.5 inch  2.189

1.  Isacord 40 1543














12380-08  89 x 89 mm
3.5 x 3.5 inch  2.725

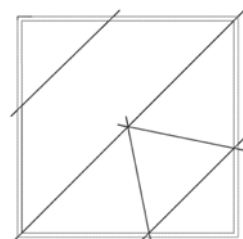
1.  Isacord 40 1543





Quilting in the hoop









12736-01  140 x 140 mm
5.5 x 5.5 inch  1.657

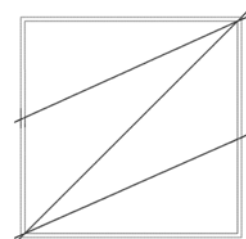
1.  Isacord 40 0020
2.  Isacord 40 0020
3.  Isacord 40 0020
4.  Isacord 40 0020
5.  Isacord 40 0020
6.  Isacord 40 0020
7.  Isacord 40 0020
8.  Isacord 40 0020
9.  Isacord 40 0020
10.  Isacord 40 0020



11.  Isacord 40 0020
12.  Isacord 40 0020

12736-02  140 x 139 mm
5.5 x 5.5 inch  1.473

1.  Isacord 40 0020
2.  Isacord 40 0020
3.  Isacord 40 0020
4.  Isacord 40 0020
5.  Isacord 40 0020
6.  Isacord 40 0020
7.  Isacord 40 0020
8.  Isacord 40 0020



12736-03 140 x 140 mm
5.5 x 5.5 inch 1.776

1. ■ Isacord 40 0020
2. ■ Isacord 40 0020
3. ■ Isacord 40 0020
4. ■ Isacord 40 0020
5. ■ Isacord 40 0020
6. ■ Isacord 40 0020
7. ■ Isacord 40 0020
8. ■ Isacord 40 0020
9. ■ Isacord 40 0020
10. ■ Isacord 40 0020
11. ■ Isacord 40 0020
12. ■ Isacord 40 0020

12736-04 140 x 140 mm
5.5 x 5.5 inch 1.846

1. ■ Isacord 40 0020
2. ■ Isacord 40 0020
3. ■ Isacord 40 0020
4. ■ Isacord 40 0020
5. ■ Isacord 40 0020
6. ■ Isacord 40 0020
7. ■ Isacord 40 0020
8. ■ Isacord 40 0020
9. ■ Isacord 40 0020
10. ■ Isacord 40 0020
11. ■ Isacord 40 0020
12. ■ Isacord 40 0020

12736-05 140 x 136 mm
5.5 x 5.3 inch 1.329

1. ■ Isacord 40 0020
2. ■ Isacord 40 0020
3. ■ Isacord 40 0020
4. ■ Isacord 40 0020
5. ■ Isacord 40 0020
6. ■ Isacord 40 0020
7. ■ Isacord 40 0020
8. ■ Isacord 40 0020

12736-06 140 x 140 mm
5.5 x 5.5 inch 1.563

1. ■ Isacord 40 0020
2. ■ Isacord 40 0020
3. ■ Isacord 40 0020
4. ■ Isacord 40 0020
5. ■ Isacord 40 0020
6. ■ Isacord 40 0020
7. ■ Isacord 40 0020
8. ■ Isacord 40 0020
9. ■ Isacord 40 0020
10. ■ Isacord 40 0020

12736-07 140 x 140 mm
5.5 x 5.5 inch 1.877

1. ■ Isacord 40 0020
2. ■ Isacord 40 0020
3. ■ Isacord 40 0020
4. ■ Isacord 40 0020
5. ■ Isacord 40 0020
6. ■ Isacord 40 0020
7. ■ Isacord 40 0020
8. ■ Isacord 40 0020
9. ■ Isacord 40 0020
10. ■ Isacord 40 0020
11. ■ Isacord 40 0020
12. ■ Isacord 40 0020
13. ■ Isacord 40 0020
14. ■ Isacord 40 0020

12736-08 136 x 140 mm
5.3 x 5.5 inch 1.407






































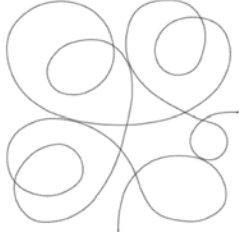

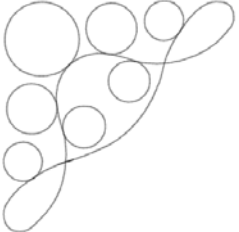
1. ■ Isacord 40 0020
2. ■ Isacord 40 0020
3. ■ Isacord 40 0020
4. ■ Isacord 40 0020
5. ■ Isacord 40 0020
6. ■ Isacord 40 0020
7. ■ Isacord 40 0020
8. ■ Isacord 40 0020

12736-09 140 x 140 mm
5.5 x 5.5 inch 1.624

1. ■ Isacord 40 0020
2. ■ Isacord 40 0020
3. ■ Isacord 40 0020
4. ■ Isacord 40 0020
5. ■ Isacord 40 0020
6. ■ Isacord 40 0020
7. ■ Isacord 40 0020
8. ■ Isacord 40 0020
9. ■ Isacord 40 0020
10. ■ Isacord 40 0020









12736-10 137 x 137 mm
5.4 x 5.4 inch 1.240

1. ■ Isacord 40 0020














































 12736-11	 152 x 152 mm 6 x 6 inch	 1.181	 12736-12	 127 x 127 mm 5 x 5 inch	 966
<p>1.  Isacord 40 0020</p> 			<p>1.  Isacord 40 0020</p> 		
 12736-13	 152 x 152 mm 6 x 6 inch	 878	 12736-14	 126 x 126 mm 4.9 x 4.9 inch	 653
<p>1.  Isacord 40 0020</p> 			<p>1.  Isacord 40 0020</p> 		
 12736-15	 127 x 126 mm 5 x 4.9 inch	 728	 12736-16	 127 x 127 mm 5 x 5 inch	 716
<p>1.  Isacord 40 0020</p> 			<p>1.  Isacord 40 0020</p> 		
 12736-17	 127 x 127 mm 5 x 5 inch	 629	 12736-18	 112 x 112 mm 4.4 x 4.4 inch	 464
<p>1.  Isacord 40 0020</p> 			<p>1.  Isacord 40 0020</p> 		

Projects

You can find the detailed embroidery instructions at <https://www.bernina.com/770PLUSdesigns>.

32152-01	 150 x 229 mm 5.9 x 9 inch	 7.265	32152-02	 100 x 135 mm 3.9 x 5.3 inch	 1.356
<p>1.  Isacord 40 0108</p> 			<p>1.  Isacord 40 0108</p> 		

Overview stitch patterns

32152-03a  188 x 220 mm 7.4 x 8.7 inch  1.803	32152-03b  179 x 196 mm 7.1 x 7.7 inch  1.847
1.  Isacord 40 0108 2.  Isacord 40 0108 	1.  Isacord 40 0108 2.  Isacord 40 0108 
32152-04  190 x 288 mm 7.5 x 11.4 inch  22.113	32152-05a  190 x 153 mm 7.5 x 6 inch  10.319
1.  Isacord 40 0108 	1.  Isacord 40 0108 2.  Isacord 40 0108 
32152-05b  184 x 176 mm 7.2 x 6.9 inch  11.845	32152-06  115 x 140 mm 4.5 x 5.5 inch  2.532
1.  Isacord 40 0108 2.  Isacord 40 0108 3.  Isacord 40 0108 	1.  Isacord 40 0108 
32152-07  115 x 140 mm 4.5 x 5.5 inch  6.565	32152-08  135 x 155 mm 5.3 x 6.1 inch  2.473
1.  Isacord 40 0108 	1.  Isacord 40 0108 
32152-09  135 x 155 mm 5.3 x 6.1 inch  7.220	32152-10  190 x 279 mm 7.5 x 11 inch  3.894
1.  Isacord 40 0108 	1.  Isacord 40 0108 



32152-11

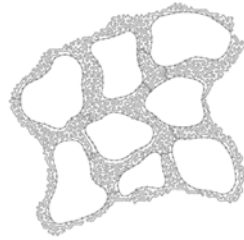


125 x 122 mm
4.9 x 4.8 inch



4.614

1. ■ Isacord 40 0108



Children

Be790305



118 x 145 mm
4.6 x 5.7 inch



13.118

1. Isacord 40 0015
2. ■ Applique 1
3. ■ Applique 3
4. ■ Isacord 40 3541
5. ■ Applique 1
6. ■ Applique 3
7. ■ Isacord 40 0345
8. ■ Applique 1
9. ■ Applique 3
10. ■ Isacord 40 1900



11. ■ Isacord 40 0020 12. Isacord 40 0015

12590-03

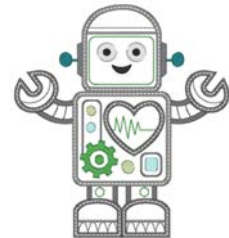


135 x 147 mm
5.3 x 5.8 inch



22.117

1. ■ Applique 1
2. ■ Applique 2
3. ■ Applique 1
4. ■ Applique 2
5. ■ Applique 1
6. ■ Applique 2
7. ■ Applique 1
8. ■ Applique 2
9. Isacord 40 0015
10. ■ Isacord 40 0020
13. ■ Isacord 40 4230
16. ■ Isacord 40 0112



11. ■ Isacord 40 5510 12. ■ Isacord 40 5650
14. ■ Isacord 40 4116 15. ■ Isacord 40 0132
17. Isacord 40 0015

Ck867



122 x 133 mm
4.8 x 5.2 inch



28.880

1. ■ Isacord 40 3722
2. ■ Isacord 40 3600
3. ■ Isacord 40 3722
4. ■ Isacord 40 5730
5. ■ Isacord 40 2761
6. ■ Isacord 40 0630
7. ■ Isacord 40 3910
8. Isacord 40 0015
9. ■ Isacord 40 0811
10. ■ Isacord 40 2830
13. ■ Isacord 40 3722



11. ■ Isacord 40 4174 12. ■ Isacord 40 1701
14. Isacord 40 0015 15. ■ Isacord 40 1430

Cm031_48



86 x 64 mm
3.4 x 2.5 inch



6.433

1. ■ Isacord 40 5730
2. ■ Isacord 40 1352
3. ■ Isacord 40 1755
4. ■ Isacord 40 1730
5. ■ Isacord 40 3820
6. ■ Isacord 40 3040



12401-17



99 x 55 mm
3.9 x 2.2 inch



1.345

1. ■ Isacord 40 0731
2. ■ Isacord 40 0630
3. ■ Isacord 40 5934
4. ■ Isacord 40 0111
5. ■ Isacord 40 4240
6. ■ Isacord 40 1342



Ck859



119 x 142 mm
4.7 x 5.6 inch





30.121


1. ■ Applique 1
2. ■ Applique 2
3. ■ Isacord 40 6051
4. ■ Isacord 40 0630
5. ■ Isacord 40 3910
6. ■ Isacord 40 0811
7. Isacord 40 0015
8. ■ Isacord 40 0904
9. ■ Isacord 40 3241
10. ■ Isacord 40 1701
13. Isacord 40 0015





11. ■ Isacord 40 4174 12. ■ Isacord 40 3815
14. ■ Isacord 40 2153


Ck520  75 x 60 mm
3 x 2.4 inch  11.019



1. Isacord 40 3906
2. Isacord 40 0132
3. Isacord 40 0015
4. Yenmet 7003
5. Isacord 40 3652
6. Isacord 40 0020
7. Isacord 40 0600
8. Isacord 40 2113




Ck510  76 x 60 mm
3 x 2.4 inch  8.069



1. Isacord 40 5934
2. Isacord 40 3840
3. Isacord 40 3901
4. Isacord 40 0108
5. Isacord 40 0015
6. Isacord 40 3622
7. Isacord 40 4174
8. Isacord 40 0015




Ck522  71 x 53 mm
2.8 x 2.1 inch  9.089

1. Isacord 40 3810
2. Isacord 40 0131
3. Isacord 40 0015
4. Isacord 40 0020
5. Isacord 40 0310
6. Isacord 40 1703
7. Yenmet 7021
8. Isacord 40 3353





Ck863  127 x 125 mm
5 x 4.9 inch  19.354


1. Applique 1
2. Applique 2
3. Isacord 40 0630
4. Isacord 40 0015
5. Isacord 40 4103
6. Isacord 40 4111
7. Isacord 40 1701
8. Isacord 40 2830
9. Isacord 40 5912
10. Isacord 40 1730
11. Isacord 40 5510
12. Isacord 40 0811
13. Isacord 40 4174
14. Isacord 40 0352
15. Isacord 40 1805
16. Isacord 40 0015
17. Isacord 40 3130





Wish Upon My Star Light


Nb198_48  94 x 72 mm
3.7 x 2.8 inch  9.711



1. Isacord 40 2650
2. Isacord 40 0713
3. Isacord 40 2166
4. Isacord 40 1755
5. Isacord 40 3251
6. Isacord 40 1600
7. Isacord 40 2153
8. Isacord 40 2152
9. Isacord 40 2761




Cm226_48  50 x 63 mm
2 x 2.5 inch  6.214



1. Isacord 40 0101
2. Isacord 40 0131
3. Isacord 40 0152
4. Isacord 40 0020
5. Isacord 40 1755




Be790307  142 x 127 mm
5.6 x 5 inch  19.667

1. Applique 1
2. Applique 3
3. Isacord 40 3130
4. Applique 1
5. Applique 3
6. Isacord 40 0003
7. Isacord 40 1720
8. Isacord 40 0020
9. Isacord 40 0520
10. Isacord 40 3541




Be790311  114 x 152 mm
4.5 x 6 inch  12.320

1. Applique 1
2. Applique 3
3. Isacord 40 0933
4. Applique 1
5. Applique 3
6. Applique 1
7. Applique 3
8. Isacord 40 0776
9. Applique 1
10. Applique 3
11. Isacord 40 1900
12. Isacord 40 0176
13. Isacord 40 0015
14. Isacord 40 0020



Be790306 132 x 151 mm 5.2 x 6 inch 18.399

- Isacord 40 0003
- Applique 1
- Applique 2
- Isacord 40 0003
- Isacord 40 3910
- Isacord 40 0230
- Isacord 40 2723
- Isacord 40 1301
- Isacord 40 2640
- Isacord 40 0003
- Isacord 40 3332



Cute Bee

Be790308 155 x 178 mm 6.1 x 7 inch 25.448


- Isacord 40 0020
- Applique 1
- Applique 2
- Isacord 40 1720



JE T'AIME MON AMOUR

Be790309 87 x 150 mm 3.4 x 5.9 inch 13.252


- Applique 1
- Applique 3
- Isacord 40 0015
- Isacord 40 1900
- Isacord 40 0020
- Isacord 40 4116
- Isacord 40 0176
- Isacord 40 0015
- Isacord 40 0310



DOG

Be790310 138 x 136 mm 5.4 x 5.4 inch 16.278


- Applique 1
- Applique 3
- Applique 1
- Applique 3
- Isacord 40 1161
- Isacord 40 1141
- Isacord 40 1161
- Isacord 40 3654
- Isacord 40 0176
- Isacord 40 1141
- Isacord 40 0020
- Isacord 40 0015
- Isacord 40 1900



I LOVE YOU


Be790312 122 x 133 mm 4.8 x 5.2 inch 22.489

- Applique 1
- Applique 3
- Applique 1
- Applique 3
- Isacord 40 0015
- Isacord 40 1600
- Isacord 40 0108
- Isacord 40 2912
- Isacord 40 3600
- Isacord 40 1141
- Isacord 40 0020



Be790313 99 x 102 mm 3.9 x 4 inch 8.788

- Applique 1
- Applique 3
- Isacord 40 3750
- Isacord 40 1114
- Isacord 40 1900
- Isacord 40 3620
- Isacord 40 2510
- Isacord 40 5324
- Isacord 40 1114
- Isacord 40 1060
- Isacord 40 4114
- Isacord 40 0020
- Isacord 40 0015




aim

Animals


12676-01 81 x 148 mm 3.2 x 5.8 inch 15.344

- Isacord 40 2171
- Isacord 40 2530
- Isacord 40 2155
- Isacord 40 2520
- Isacord 40 2500














Cm263_48 116 x 192 mm 4.6 x 7.6 inch 14.402

- Isacord 40 3151
- Isacord 40 0532
- Isacord 40 1755
- Isacord 40 2171
- Isacord 40 2761
- Isacord 40 0015
- Isacord 40 0020
- Isacord 40 2155



Overview stitch patterns

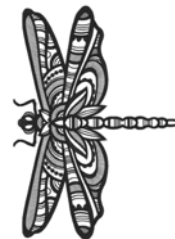
12389-10  53 x 45 mm
2.1 x 1.8 inch  2.784


1.  Isacord 40 0020
2.  Yenmet 7003
3.  Isacord 40 0170
4.  Isacord 40 0811
5.  Isacord 40 0940
6.  Isacord 40 0800
7.  Isacord 40 0713
8.  Isacord 40 0933
9.  Isacord 40 0020







12760-02  122 x 171 mm
4.8 x 6.7 inch  21.512

1.  Isacord 40 0020










Wp415_48  132 x 148 mm
5.2 x 5.8 inch  25.110



1.  Isacord 40 0941
2.  Isacord 40 0532
3.  Isacord 40 0945
4.  Isacord 40 0020










Cm216_48  47 x 67 mm
1.9 x 2.6 inch  5.046


1.  Isacord 40 1010
2.  Isacord 40 0101
3.  Isacord 40 0132
4.  Isacord 40 0020
5.  Isacord 40 0124
6.  Isacord 40 1010
7.  YLI variations 8012






Cm213_48  58 x 102 mm
2.3 x 4 inch  7.866


1.  Isacord 40 1840
2.  Isacord 40 1055
3.  Isacord 40 1252
4.  Isacord 40 0651
5.  Isacord 40 0660
6.  Isacord 40 0020
7.  Isacord 40 1055












Wp421_48  96 x 137 mm
3.8 x 5.4 inch  14.219

1.  Isacord 40 1161
2.  Isacord 40 1876
3.  Isacord 40 1154
















Na248  78 x 73 mm
3.1 x 2.9 inch  10.132

1.  Isacord 40 0101
2.  Isacord 40 3971
3.  Isacord 40 2220
4.  Isacord 40 0132
5.  Isacord 40 2051
6.  Isacord 40 2155
7.  Isacord 40 2320
8.  Isacord 40 2220
9.  Yenmet 7023











Hd977  98 x 98 mm
3.8 x 3.9 inch  13.738

1.  Isacord 40 3962
2.  Isacord 40 0015
3.  Isacord 40 0640
4.  Isacord 40 0824
5.  Isacord 40 2650
6.  Isacord 40 0020
7.  Isacord 40 0142
8.  Isacord 40 0640
9.  Isacord 40 0824
10.  Isacord 40 2650
11.  Isacord 40 2830
12.  Isacord 40 1352
13.  Yenmet 7029

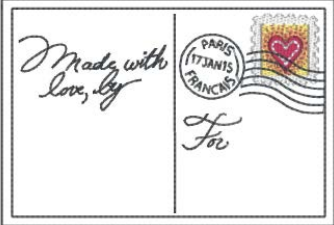
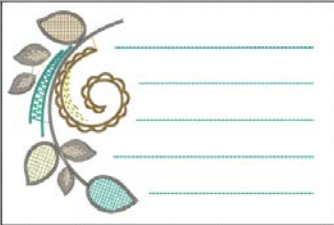
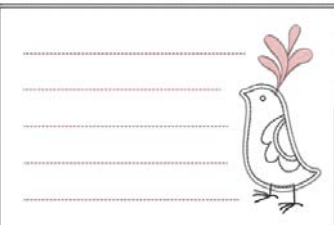

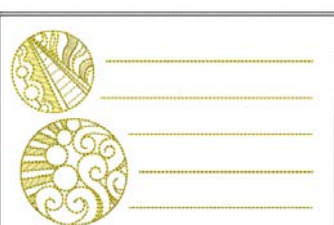
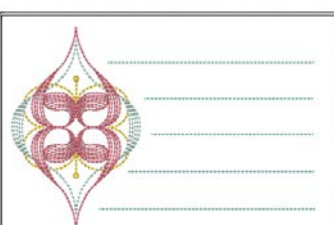
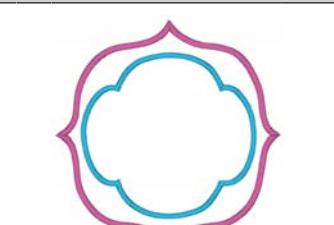
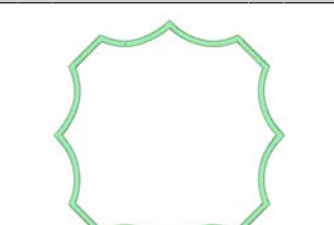




Lj598  106 x 81 mm
4.2 x 3.2 inch  15.746

1.  Isacord 40 0101
2.  Isacord 40 0131
3.  Isacord 40 0132
4.  Isacord 40 4174
5.  Isacord 40 0108
6.  Isacord 40 0020
7.  Isacord 40 5933
8.  Isacord 40 0453



Borders

<p>12383-09</p> <p>1. Isacord 40 0020 2. Isacord 40 4174 3. Isacord 40 0608 4. Isacord 40 2101 5. Isacord 40 1600 6. Isacord 40 0015 7. Isacord 40 4174</p>	<p>113 x 77 mm 4.4 x 3 inch</p> <p>4.757</p> 	<p>12621-19</p> <p>1. Isacord 40 0015 2. Isacord 40 0015 3. Isacord 40 0721 4. Isacord 40 4620 5. Isacord 40 0352 6. Isacord 40 0152 7. Isacord 40 0672 8. Isacord 40 4620 9. Isacord 40 0015</p>	<p>155 x 104 mm 6.1 x 4.1 inch</p> <p>8.360</p> 
<p>12621-04</p> <p>1. Isacord 40 0015 2. Isacord 40 0015 3. Isacord 40 0020 4. Isacord 40 2051 5. Isacord 40 0015 6. Isacord 40 4174 7. Isacord 40 2051 8. Isacord 40 0015</p>	<p>155 x 104 mm 6.1 x 4.1 inch</p> <p>3.803</p> 	<p>12621-05</p> <p>1. Isacord 40 0015 2. Isacord 40 0015 3. Isacord 40 0933 4. Isacord 40 1252 5. Isacord 40 1252 6. Isacord 40 0015</p>	<p>155 x 104 mm 6.1 x 4.1 inch</p> <p>5.811</p> 
<p>12621-09</p> <p>1. Isacord 40 0015 2. Isacord 40 0015 3. Isacord 40 0504 4. Isacord 40 0542 5. Isacord 40 0542 6. Isacord 40 0015</p>	<p>155 x 104 mm 6.1 x 4.1 inch</p> <p>5.520</p> 	<p>12621-02</p> <p>1. Isacord 40 0020 2. Isacord 40 0020 3. Isacord 40 0811 4. Isacord 40 4952 5. Isacord 40 1921 6. Isacord 40 4952 7. Isacord 40 0020</p>	<p>155 x 104 mm 6.1 x 4.1 inch</p> <p>5.558</p> 
<p>80090-26</p> <p>1. Applique 1 2. Applique 2 3. Applique 1 4. Applique 2 5. Isacord 40 4103 6. Isacord 40 2508</p>	<p>124 x 129 mm 4.9 x 5.1 inch</p> <p>6.087</p> 	<p>12611-27</p> <p>1. Applique 1 2. Applique 2 3. Isacord 40 5440</p>	<p>137 x 137 mm 5.4 x 5.4 inch</p> <p>3.961</p> 
<p>12611-28</p> <p>1. Applique 1 2. Applique 2 3. Isacord 40 0703</p>	<p>140 x 140 mm 5.5 x 5.5 inch</p> <p>3.649</p> 	<p>12649-05</p> <p>1. Isacord 40 1840 2. Isacord 40 1840 3. Isacord 40 1840 4. Isacord 40 1860 5. Isacord 40 0015</p>	<p>91 x 88 mm 3.6 x 3.5 inch</p> <p>9.087</p> 

12606-26 139 x 139 mm
5.5 x 5.5 inch 5.211

1. Isacord 40 0670
2. Isacord 40 0670
3. Isacord 40 0670



12606-33 43 x 70 mm
1.7 x 2.8 inch 2.376

1. Isacord 40 0670
2. Isacord 40 0670
3. Isacord 40 0670



12606-37 46 x 78 mm
1.8 x 3.1 inch 2.692

1. Isacord 40 0670
2. Isacord 40 0670
3. Isacord 40 0670



12611-21 156 x 72 mm
6.1 x 2.8 inch 11.513

1. Applique 1
2. Applique 2
3. Isacord 40 1703



12611-23 156 x 72 mm
6.1 x 2.8 inch 12.817

1. Applique 1
2. Applique 2
3. Isacord 40 1902



12611-22 156 x 72 mm
6.1 x 2.8 inch 12.504

1. Applique 1
2. Applique 2
3. Isacord 40 1703



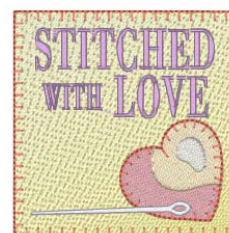
12611-24 156 x 72 mm
6.1 x 2.8 inch 12.613

1. Applique 1
2. Applique 2
3. Isacord 40 1902



Nz195 77 x 77 mm
3 x 3 inch 15.343

1. Isacord 40 0660
2. Isacord 40 0713
3. Isacord 40 2153
4. Isacord 40 1362
5. Isacord 40 0870
6. Isacord 40 2830
7. Isacord 40 1725
8. Isacord 40 4071



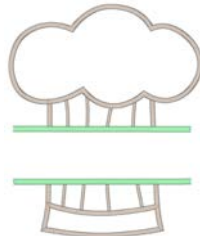










Nx763 87 x 72 mm
3.4 x 2.8 inch 14.953




1. Isacord 40 2155
2. Isacord 40 0520
3. Isacord 40 1921
4. Isacord 40 5912
5. Isacord 40 5510
6. Isacord 40 3040
7. Isacord 40 0310
8. Isacord 40 3910
9. Isacord 40 0442
10. Isacord 40 2830



Sport and hobbies



<p>82014-28 142 x 117 mm 5.6 x 4.6 inch 26.582</p> <ol style="list-style-type: none"> Applique 1 Applique 2 Isacord 40 0105 Isacord 40 0020 Isacord 40 4073 Isacord 40 1902 	<p>12611-08 80 x 120 mm 3.1 x 4.7 inch 5.770</p> <ol style="list-style-type: none"> Isacord 40 1154 Isacord 40 1154 Isacord 40 1154 Isacord 40 1154 Isacord 40 1154 Isacord 40 5440 Isacord 40 1902 
<p>12611-18 130 x 158 mm 5.1 x 6.2 inch 8.045</p> <ol style="list-style-type: none"> Isacord 40 0151 Isacord 40 0151 Isacord 40 0151 Isacord 40 5440 	<p>Nx737 72 x 99 mm 2.8 x 3.9 inch 10.793</p> <ol style="list-style-type: none"> Isacord 40 0015 Yenmet 7005 Isacord 40 3962 Isacord 40 0020 
<p>Nx741 80 x 78 mm 3.1 x 3.1 inch 11.206</p> <ol style="list-style-type: none"> Isacord 40 0131 Isacord 40 0111 Isacord 40 0970 Isacord 40 0015 Isacord 40 3971 Yenmet 7009 Yenmet 7003 Isacord 40 4230 Isacord 40 4174 	<p>12383-18 91 x 171 mm 3.6 x 6.7 inch 5.182</p> <ol style="list-style-type: none"> Isacord 40 4174 
<p>12472-01 138 x 142 mm 5.4 x 5.6 inch 23.233</p> <ol style="list-style-type: none"> Isacord 40 2504 Isacord 40 3901 Isacord 40 5610 Isacord 40 4240 Applique 1 Applique 2 Isacord 40 1123 Isacord 40 0761 Isacord 40 1902 Isacord 40 2504 Isacord 40 3901 Isacord 40 5610 Isacord 40 4240 Isacord 40 1300 	<p>Be790606 100 x 86 mm 3.9 x 3.4 inch 7.445</p> <ol style="list-style-type: none"> Isacord 40 0020 Isacord 40 1306 
<p>Be790608 80 x 80 mm 3.2 x 3.1 inch 7.937</p> <ol style="list-style-type: none"> Isacord 40 0020 	<p>Be790603 80 x 75 mm 3.2 x 2.9 inch 11.824</p> <ol style="list-style-type: none"> Isacord 40 0015 Isacord 40 3654 









Be790602  80 x 75 mm
3.1 x 3 inch  10.169

1.  Isacord 40 5643
2.  Isacord 40 5912
3.  Isacord 40 0015









Embellishment

Nb843_48  87 x 121 mm
3.4 x 4.8 inch  8.976

1.  Isacord 40 9971
2.  Isacord 40 9937
3.  Isacord 40 9925
4.  Isacord 40 9975
5.  Isacord 40 9978
6.  Isacord 40 9973
7.  Isacord 40 9982
8.  Isacord 40 1972




Nb826_48  135 x 133 mm
5.3 x 5.2 inch  11.154



1.  Isacord 40 9971
2.  Isacord 40 9978
3.  Isacord 40 9973
4.  Isacord 40 1972





12633-06  120 x 120 mm
4.7 x 4.7 inch  18.023


1.  Isacord 40 0015





12473-04  94 x 184 mm
3.7 x 7.3 inch  11.531



1.  Isacord 40 5552
2.  Isacord 40 5374





Be790403  140 x 130 mm
5.5 x 5.1 inch  13.281




1.  Isacord 40 0020
2.  Isacord 40 0731



12473-06  133 x 120 mm
5.3 x 4.7 inch  11.358

1.  Isacord 40 4610
2.  Isacord 40 5633






 **80090-06**  84 x 37 mm
3.3 x 1.4 inch  3.766
































































1.  Applique 1
2.  Applique 2
3.  Isacord 40 4103







































































 **80090-07**  128 x 36 mm
5 x 1.4 inch  5.450

1.  Applique 1
2.  Applique 2
3.  Isacord 40 5440



<p>19999-002  125 x 136 mm 4.9 x 5.4 inch  10.184</p>	<p>Nb934_48  132 x 165 mm 5.2 x 6.5 inch  9.168</p>
<p>1. Isacord 40 0015 2. Isacord 40 0015 3. Isacord 40 0015</p> 	<p>1.  Isacord 40 2241 2.  Isacord 40 1154 3.  Isacord 40 1346 4.  Isacord 40 1161 5.  Isacord 40 2222 6.  Isacord 40 5833 7.  Isacord 40 1154 8.  Isacord 40 2241</p> 
<p>Nb935_48  104 x 169 mm 4.1 x 6.6 inch  10.171</p>	<p>21021-05  119 x 156 mm 4.7 x 6.1 inch  14.326</p>
<p>1.  Isacord 40 2222 2.  Isacord 40 1346 3.  Isacord 40 0232 4.  Isacord 40 1154 5.  Isacord 40 5833 6.  Isacord 40 2241</p> 	<p>1.  Isacord 40 1252 2.  Isacord 40 1161 3.  Isacord 40 1565</p> 
<p>21021-04  123 x 150 mm 4.8 x 5.9 inch  16.176</p>	<p>21021-06  116 x 109 mm 4.6 x 4.3 inch  12.204</p>
<p>1.  Isacord 40 1161 2.  Isacord 40 1252 3.  Isacord 40 1565</p> 	<p>1.  Isacord 40 1161 2.  Isacord 40 1252 3.  Isacord 40 1565</p> 
<p>12490-03  118 x 113 mm 4.6 x 4.5 inch  6.669</p>	<p>12490-04  146 x 122 mm 5.8 x 4.8 inch  8.724</p>
<p>1.  Isacord 40 0108 2.  Isacord 40 3641 3.  Isacord 40 3652</p> 	<p>1.  Isacord 40 0108 2.  Isacord 40 3641 3.  Isacord 40 3652</p> 
<p>12490-05  126 x 104 mm 4.9 x 4.1 inch  6.148</p>	<p>Fp887  135 x 187 mm 5.3 x 7.4 inch  12.658</p>
<p>1.  Isacord 40 0108 2.  Isacord 40 3641 3.  Isacord 40 3652</p> 	<p>1.  Isacord 40 2504</p> 

12528-12  124 x 124 mm 4.9 x 4.9 inch  39.751	12528-03  76 x 130 mm 3 x 5.1 inch  16.171
<ol style="list-style-type: none"> 1.  Isacord 40 0931 2.  Isacord 40 0824 3.  Isacord 40 0851 	<ol style="list-style-type: none"> 1.  Isacord 40 0851 2.  Isacord 40 0824 3.  Isacord 40 0931 
Oc07207  106 x 138 mm 4.2 x 5.4 inch  17.807	82007-11  112 x 94 mm 4.4 x 3.7 inch  13.622
<ol style="list-style-type: none"> 1.  Yenmet 7012 2.  Isacord 40 0670 3.  Yenmet 7012 	<ol style="list-style-type: none"> 1. Isacord 40 0015 2.  Isacord 40 2520 3. Isacord 40 0015 4.  Isacord 40 0761 5.  Isacord 40 0761 6.  Isacord 40 1805 7.  Isacord 40 2152 8.  Isacord 40 2520 9.  Isacord 40 2500 10.  Isacord 40 2115 11.  Isacord 40 0761 
82007-44  114 x 115 mm 4.5 x 4.5 inch  9.467	82006-30  100 x 174 mm 3.9 x 6.9 inch  21.584
<ol style="list-style-type: none"> 1.  Isacord 40 2152 2.  Isacord 40 2520 	<ol style="list-style-type: none"> 1.  Isacord 40 0020 2.  Isacord 40 4174 3.  Isacord 40 0020 4.  Isacord 40 4174 5.  Isacord 40 0771 6.  Isacord 40 0832 7.  Isacord 40 0108 8.  Isacord 40 4174 9.  Isacord 40 0660 10.  Isacord 40 1526 
Nb251_48  72 x 103 mm 2.8 x 4.1 inch  8.612	Be790405  126 x 185 mm 4.9 x 7.3 inch  7.734
<ol style="list-style-type: none"> 1.  Isacord 40 2155 2.  Isacord 40 2504 3.  Isacord 40 0020 4.  Isacord 40 0020 	<ol style="list-style-type: none"> 1.  Isacord 40 3102 
Fb126  87 x 102 mm 3.4 x 4 inch  2.668	Be790407  200 x 271 mm 7.9 x 10.7 inch  19.455
<ol style="list-style-type: none"> 1.  Isacord 40 1220 2.  Isacord 40 1805 	<ol style="list-style-type: none"> 1.  Isacord 40 2510 

Be790502



60 x 58 mm
2.4 x 2.3 inch



1.814

1. Isacord 40 3541



Borders and Lace



12659-01



45 x 58 mm
1.8 x 2.3 inch



6.790

1. Isacord 40 1352
2. Isacord 40 1430



12659-06



37 x 59 mm
1.4 x 2.3 inch



6.465

1. Isacord 40 4625
2. Isacord 40 4515



21021-25



34 x 71 mm
1.3 x 2.8 inch



4.748

1. Isacord 40 1252



Oc00303



101 x 110 mm
4 x 4.4 inch



35.018

1. Isacord 40 0015



12633-20



34 x 170 mm
1.4 x 6.7 inch



12.897

1. Isacord 40 0015



12508-08



40 x 151 mm
1.6 x 5.9 inch



7.102

1. Isacord 40 0352
2. Isacord 40 4752
3. Isacord 40 0124



12508-17



42 x 152 mm
1.6 x 6 inch



7.962

1. Isacord 40 0352
2. Isacord 40 4752
3. Isacord 40 5552



Oc33411



24 x 177 mm
0.9 x 7 inch




















































15.868




1. Isacord 40 0015





Overview stitch patterns



<p>Oc33416  36 x 128 mm 1.4 x 5 inch  16.090</p> <p>1.  Isacord 40 1902 2.  Isacord 40 0015</p> 	<p>12485-12  41 x 139 mm 1.6 x 5.5 inch  3.391</p> <p>1.  Isacord 40 1134 2.  Isacord 40 0520 3.  Isacord 40 4240 4.  Isacord 40 4111 5.  Isacord 40 0702 6.  Isacord 40 1430</p> 
<p>12485-31  46 x 225 mm 1.8 x 8.9 inch  2.174</p> <p>1.  Isacord 40 0702 2.  Isacord 40 0520</p> 	<p>21013-29  152 x 40 mm 6 x 1.6 inch  7.569</p> <p>1.  Isacord 40 4332</p> 
<p>Be110415  44 x 172 mm 1.7 x 6.8 inch  6.436</p> <p>1.  Isacord 40 6051 2.  Isacord 40 0811 3.  Isacord 40 1921</p> 	<p>Fa981  35 x 142 mm 1.4 x 5.6 inch  3.709</p> <p>1.  Isacord 40 1055</p> 
<p>21002-21  151 x 21 mm 5.9 x 0.8 inch  3.176</p> <p>1.  Isacord 40 1252</p> 	<p>21009-29  32 x 152 mm 1.3 x 6 inch  4.649</p> <p>1.  Isacord 40 5210</p> 
<p>82005-40  26 x 240 mm 1 x 9.4 inch  8.256</p> <p>1.  Isacord 40 0851</p> 	<p>Be790702  73 x 190 mm 2.9 x 7.5 inch  9.135</p> <p>1.  Isacord 40 0442</p> 

Na914_48  19 x 120 mm
0.7 x 4.7 inch  4.691


1.  Isacord 40 3151
2.  Isacord 40 3251
3.  Isacord 40 3150






Cm473_48  32 x 209 mm
1.2 x 8.2 inch  8.963

1.  Isacord 40 3920
2.  Isacord 40 3962












Fb436_48  29 x 133 mm
1.1 x 5.2 inch  4.735

1.  Isacord 40 3130
2.  Isacord 40 3150
3.  Isacord 40 4240









Seasons

 **82023-14**  119 x 123 mm
4.7 x 4.8 inch  14.989

1.  Isacord 40 1753
2.  Isacord 40 1753
3.  Isacord 40 1753
4.  Isacord 40 0010
5.  Isacord 40 5100
6.  Isacord 40 5210
7.  Isacord 40 5220
8.  Isacord 40 2101
9.  Isacord 40 1753









 **82023-15**  124 x 152 mm
4.9 x 6 inch  9.577



1.  Isacord 40 5210
2.  Isacord 40 5220
3.  Isacord 40 5100
4.  Isacord 40 1805
5.  Isacord 40 2101
6.  Isacord 40 1753








 **82023-13**  106 x 156 mm
4.2 x 6.1 inch  11.315



1.  Isacord 40 5220
2.  Isacord 40 1753
3.  Isacord 40 1805
4.  Isacord 40 2101
5.  Isacord 40 5210
6.  Isacord 40 5100




Hg795_48  89 x 164 mm
3.5 x 6.5 inch  3.453

1.  Isacord 40 5730
2.  Isacord 40 5513
3.  Isacord 40 4430
4.  Isacord 40 1032
5.  Isacord 40 1900
6.  Isacord 40 4113





 **12597-16**  88 x 85 mm
3.5 x 3.3 inch  15.862



1.  Isacord 40 0904
2.  Isacord 40 0940






12858-04  159 x 164 mm
6.3 x 6.4 inch  16.385



1.  Isacord 40 0015
2.  Isacord 40 0015
























80009-17  86 x 130 mm
3.4 x 5.1 inch  6.582

1.  Isacord 40 5934
2.  Isacord 40 5866
3.  Isacord 40 5934





























He255  133 x 127 mm
5.2 x 5 inch  17.198

1.  Isacord 40 0111
2.  Applique 1
3.  Applique 2
4.  Applique 3
5.  Isacord 40 1800
6.  Isacord 40 2640
7.  Isacord 40 5650
8.  Isacord 40 5610
9.  Isacord 40 0015
10.  Isacord 40 0111
11.  Isacord 40 1060
12.  Isacord 40 3910
13.  Isacord 40 0800
14.  Isacord 40 0940
15.  Applique 1
16.  Applique 2
17.  Applique 3
18.  Isacord 40 0832
19.  Isacord 40 3650
20.  Isacord 40 1351
21.  Isacord 40 0108



















He252  88 x 145 mm
3.5 x 5.7 inch  12.251



1.  Applique 1
2.  Applique 2
3.  Applique 3
4.  Applique 1
5.  Applique 2
6.  Applique 3
7.  Isacord 40 0842
8.  Isacord 40 1902
9.  Isacord 40 0651
10.  Isacord 40 1123
11.  Isacord 40 5220
12.  Isacord 40 5210
13.  Isacord 40 5422
14.  Isacord 40 0101
15.  Isacord 40 1430
16.  Isacord 40 1725
17.  Isacord 40 0520
18.  Isacord 40 0824
19.  Applique 1
20.  Applique 2
21.  Applique 3
22.  Isacord 40 1902
23.  Isacord 40 3650
24.  Isacord 40 1123
25.  Isacord 40 5324
26.  Isacord 40 1154














Hg746_48  112 x 138 mm
4.4 x 5.4 inch  17.815

1.  Isacord 40 3040
2.  Applique 1
3.  Applique 2
4.  Isacord 40 0221
5.  Applique 1
6.  Applique 2
7.  Isacord 40 0142
8.  Isacord 40 0108
9.  Applique 1
10.  Applique 2
11.  Isacord 40 0800
12.  Isacord 40 0020
13.  Isacord 40 1200
14.  Isacord 40 0020
15.  Isacord 40 0670
16.  Isacord 40 0142




















Rc514  74 x 99 mm
2.9 x 3.9 inch  15.603

1.  Isacord 40 1172
2.  Isacord 40 0842
3.  Isacord 40 0651
4.  Isacord 40 0821
5.  Isacord 40 0941
6.  Isacord 40 0101
7.  Isacord 40 0640
8.  Isacord 40 3910
9.  Isacord 40 4103
10.  Isacord 40 3522
11.  Isacord 40 0842













Hg747_48  124 x 147 mm
4.9 x 5.8 inch  18.378


1.  Isacord 40 0970
2.  Isacord 40 3770
3.  Isacord 40 5912
4.  Isacord 40 0520
5.  Isacord 40 0811
6.  Isacord 40 3350
7.  Isacord 40 3040
8.  Applique 1
9.  Applique 2
10.  Applique 1
11.  Applique 2
12.  Applique 1
13.  Applique 2
14.  Isacord 40 4073
15.  Isacord 40 0020
16.  Isacord 40 1200
17.  Isacord 40 0101








Nb754_48  114 x 128 mm
4.5 x 5 inch  13.084



1.  Yenmet 7037
2.  Isacord 40 2155
3.  Isacord 40 0651
4.  Isacord 40 0101
5.  Isacord 40 2532
6.  Isacord 40 0640
7.  Isacord 40 1352
8.  Yenmet 7030
9.  Isacord 40 0232
10.  Isacord 40 1123




Nb759_48  99 x 62 mm
3.9 x 2.4 inch  4.937

1.  Yenmet 7037
2.  Isacord 40 0640
3.  Isacord 40 1352
4.  Isacord 40 0232
5.  Isacord 40 1123



Hd976  101 x 108 mm
4 x 4.3 inch  18.674



1. Isacord 40 3962
2. Yenmet 7029
3. Isacord 40 0640
4. Isacord 40 0824
5. Isacord 40 0015
6. Isacord 40 0020
7. Isacord 40 0142
8. Isacord 40 3962
9. Isacord 40 0020
10. Isacord 40 0934
11. Isacord 40 0640
12. Isacord 40 0824
13. Isacord 40 5650
14. Isacord 40 5531
15. Isacord 40 1220
16. Isacord 40 5822
17. Isacord 40 5531
18. Isacord 40 0015
19. Isacord 40 5822



Hg806_48  28 x 170 mm
1.1 x 6.7 inch  4.988



1. Isacord 40 2530
2. Isacord 40 1900
3. Isacord 40 5730
4. Isacord 40 1114
5. Isacord 40 4430
6. Isacord 40 4113



12415-32  80 x 191 mm
3.1 x 7.5 inch  10.937



1. YLI variations 8019



12415-29  108 x 172 mm
4.3 x 6.8 inch  4.814


1. YLI variations 8019



12655-14  164 x 110 mm
6.4 x 4.4 inch  16.122



1. Isacord 40 1115
2. Isacord 40 1055



12433-05  83 x 124 mm
3.3 x 4.9 inch  15.348



1. Isacord 40 1725
2. Isacord 40 5934
3. Isacord 40 0442
4. Isacord 40 2115
5. Isacord 40 2711



12417-04  84 x 97 mm
3.3 x 3.8 inch  8.085



1. Isacord 40 1010
2. Isacord 40 0811
3. Isacord 40 1311
4. Isacord 40 1543



Be790303  70 x 70 mm
2.7 x 2.8 inch  5.764



1. Isacord 40 0532
2. Isacord 40 1300
3. Isacord 40 0020
4. Isacord 40 0015



Be790301  127 x 89 mm
5 x 3.5 inch  10.153



1. Isacord 40 1161
2. Isacord 40 1860
3. Isacord 40 1805
4. Isacord 40 4116
5. Isacord 40 1114
6. Isacord 40 0532
7. Isacord 40 0731
8. Isacord 40 1322
9. Isacord 40 1141
10. Isacord 40 0020




12421-11  40 x 43 mm
1.6 x 1.7 inch  3.965

1. Isacord 40 0800
2. Isacord 40 0904
3. Isacord 40 0020
4. Isacord 40 0015













12421-37  67 x 61 mm
2.6 x 2.4 inch  1.320

1.  Isacord 40 0020






Flowers













Fq987_48  119 x 160 mm
4.7 x 6.3 inch  32.494

1.  Isacord 40 5650
2.  Isacord 40 5833
3.  Isacord 40 0352
4.  Isacord 40 5934
5.  Isacord 40 0465
6.  Isacord 40 0015
7.  Isacord 40 0781
8.  Isacord 40 0170
9.  Isacord 40 0731
10.  Isacord 40 0640









11.  Isacord 40 0352
12.  Isacord 40 6133













 **12505-03**  108 x 162 mm
4.3 x 6.4 inch  8.606

1.  Isacord 40 0442
2.  Isacord 40 5822
3.  Isacord 40 5822
4.  Isacord 40 6031
5.  Isacord 40 5633
6.  Isacord 40 2810
7.  Isacord 40 2530
8.  Isacord 40 2530
9.  Isacord 40 2155
10.  Isacord 40 0811
13.  Isacord 40 2830
16.  Isacord 40 0311










11.  Isacord 40 0811
12.  Isacord 40 2830
14.  Isacord 40 2504
15.  Isacord 40 4103
17.  Isacord 40 0931
18.  Isacord 40 0020













 **12505-11**  104 x 174 mm
4.1 x 6.9 inch  11.419

1.  Isacord 40 0442
2.  Isacord 40 5822
3.  Isacord 40 5822
4.  Isacord 40 6031
5.  Isacord 40 5633
6.  Isacord 40 2810
7.  Isacord 40 2810
8.  Isacord 40 0811
9.  Isacord 40 0811
10.  Isacord 40 1800
13.  Isacord 40 0931
16.  Isacord 40 1912











11.  Isacord 40 1800
12.  Isacord 40 0504
14.  Isacord 40 2900
15.  Isacord 40 2530
17.  Isacord 40 1543
18.  Isacord 40 0020











 **12505-04**  124 x 176 mm
4.9 x 6.9 inch  11.861

1.  Isacord 40 3840
2.  Isacord 40 3840
3.  Isacord 40 3815
4.  Isacord 40 0311
5.  Isacord 40 5822
6.  Isacord 40 5822
7.  Isacord 40 6031
8.  Isacord 40 5633
9.  Isacord 40 0811
10.  Isacord 40 0811
13.  Isacord 40 2300
16.  Isacord 40 0504





11.  Isacord 40 2530
12.  Isacord 40 2530
14.  Isacord 40 2155
15.  Isacord 40 0931
17.  Isacord 40 0020
18.  Isacord 40 0442










 **12505-10**  102 x 134 mm
4 x 5.3 inch  5.685

1.  Isacord 40 4103
2.  Isacord 40 0442
3.  Isacord 40 5822
4.  Isacord 40 5822
5.  Isacord 40 6031
6.  Isacord 40 5633
7.  Isacord 40 1800
8.  Isacord 40 1800
9.  Isacord 40 2504
10.  Isacord 40 0504





11.  Isacord 40 0020


Fq472_48  123 x 123 mm
4.8 x 4.8 inch  4.361



1.  Isacord 40 5610
2.  Isacord 40 2830
3.  Isacord 40 5822
4.  Isacord 40 5664
5.  Isacord 40 5643
6.  Isacord 40 0015
7.  Isacord 40 0811
8.  Isacord 40 5633
9.  Isacord 40 1725




Fq464_48  110 x 104 mm
4.3 x 4.1 inch  7.122



1. Isacord 40 5822
2. Isacord 40 5552
3. Isacord 40 5650
4. Isacord 40 1913
5. Isacord 40 1725
6. Isacord 40 2115




21027-01  123 x 122 mm
4.8 x 4.8 inch  6.211



1. Isacord 40 1805
2. Isacord 40 2721
3. Isacord 40 2520
4. Isacord 40 5100
5. Isacord 40 4114
6. Isacord 40 4103
7. Isacord 40 0506
8. Isacord 40 5115




21027-14  121 x 121 mm
4.8 x 4.8 inch  7.316



1. Isacord 40 5115
2. Isacord 40 2721
3. Isacord 40 4114
4. Isacord 40 2520
5. Isacord 40 0506
6. Isacord 40 5100
7. Isacord 40 1805
8. Isacord 40 5115
9. Isacord 40 1805




21027-16  57 x 152 mm
2.3 x 6 inch  4.222



1. Isacord 40 1805
2. Isacord 40 2520
3. Isacord 40 2721
4. Isacord 40 5100
5. Isacord 40 0506
6. Isacord 40 5115
7. Isacord 40 4114
8. Isacord 40 5115
9. Isacord 40 1805




21027-17  57 x 152 mm
2.3 x 6 inch  4.179



1. Isacord 40 1805
2. Isacord 40 2723
3. Isacord 40 2520
4. Isacord 40 5100
5. Isacord 40 0506
6. Isacord 40 4103
7. Isacord 40 4114
8. Isacord 40 5115
9. Isacord 40 1805




21017-01  104 x 158 mm
4.1 x 6.2 inch  11.928



1. Isacord 40 0453
2. Isacord 40 0442
3. Isacord 40 0345
4. Isacord 40 1301
5. Isacord 40 0702
6. Isacord 40 1102
7. Isacord 40 0761
8. Isacord 40 0640




Fl135  88 x 87 mm
3.5 x 3.4 inch  12.688



1. Isacord 40 5633
2. Isacord 40 5822
3. Isacord 40 5326
4. Isacord 40 0870
5. Isacord 40 3241




Fl136  85 x 89 mm
3.3 x 3.5 inch  8.501



1. Isacord 40 0311
2. Isacord 40 5326
3. Isacord 40 5374
4. Isacord 40 0101
5. Isacord 40 3951




Fl138  85 x 75 mm
3.3 x 3 inch  6.321

1. Isacord 40 5934
2. Isacord 40 5633
3. Isacord 40 3331
4. Isacord 40 3211
5. Isacord 40 5326
















































































Fl142  79 x 86 mm
3.1 x 3.4 inch  10.298






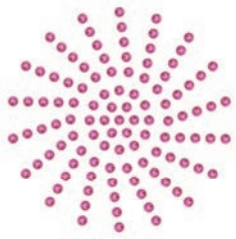





























































1. Isacord 40 2830
2. Isacord 40 3541
3. Isacord 40 2830
4. Isacord 40 1912
5. Isacord 40 0108
6. Isacord 40 3842
7. Isacord 40 0453
8. Isacord 40 5326



Overview stitch patterns

F1230  78 x 72 mm 3.1 x 2.9 inch  6.959	F1171  70 x 89 mm 2.7 x 3.5 inch  11.783
<ol style="list-style-type: none"> 1.  Isacord 40 0600 2.  Isacord 40 5933 3.  Isacord 40 5944 	<ol style="list-style-type: none"> 1.  Isacord 40 5100 2.  Isacord 40 5100 3.  Isacord 40 5326 4.  Isacord 40 2600 5.  Isacord 40 3040 
82006-07  124 x 166 mm 4.9 x 6.5 inch  22.673	21006-02  114 x 135 mm 4.5 x 5.3 inch  9.132
<ol style="list-style-type: none"> 1.  Isacord 40 4174 2.  Isacord 40 0108 3.  Isacord 40 0643 4.  Isacord 40 0660 5.  Isacord 40 0643 6.  Isacord 40 4421 7.  Isacord 40 1526 8.  Isacord 40 0660 9.  Isacord 40 4174 	<ol style="list-style-type: none"> 1.  Isacord 40 3910 2.  Isacord 40 3900 3.  Isacord 40 0015 4.  Isacord 40 3962 5.  Isacord 40 3900 6.  Isacord 40 0015 
80001-23  85 x 102 mm 3.4 x 4 inch  4.257	12457-06  106 x 172 mm 4.2 x 6.8 inch  12.636
<ol style="list-style-type: none"> 1.  Isacord 40 1102 2.  Isacord 40 1805 3.  Isacord 40 6011 4.  Isacord 40 4174 	<ol style="list-style-type: none"> 1.  Isacord 40 3150 2.  Isacord 40 3210 3.  Isacord 40 0311 4.  Isacord 40 3331 5.  Isacord 40 3711 6.  Isacord 40 2250 7.  Isacord 40 2241 8.  Isacord 40 2051 
12457-13  113 x 130 mm 4.4 x 5.1 inch  6.676	21009-21  65 x 108 mm 2.6 x 4.2 inch  4.343
<ol style="list-style-type: none"> 1.  Isacord 40 6051 2.  Isacord 40 5730 3.  Isacord 40 5722 4.  Isacord 40 2905 5.  Isacord 40 0311 6.  Isacord 40 5115 7.  Isacord 40 5220 8.  Isacord 40 5100 	<ol style="list-style-type: none"> 1.  Isacord 40 5220 2.  Isacord 40 5210 
Be790408  58 x 90 mm 2.3 x 3.5 inch  2.045	Be790401  206 x 242 mm 8.1 x 9.5 inch  11.593
<ol style="list-style-type: none"> 1.  Isacord 40 3541 	<ol style="list-style-type: none"> 1.  Isacord 40 1900 

DesignWorks

<p>Dw11  70 x 71 mm 2.8 x 2.8 inch  110</p>	<p>21026-08_dw  86 x 174 mm 3.4 x 6.9 inch  11.047</p>
<p>1.  Swarovski 0502</p> 	<p>1.  Edding 69 2.  Isacord 40 0020</p> 
<p>21026-02_dw  69 x 194 mm 2.7 x 7.6 inch  7.815</p>	<p>21026-02_cr  104 x 127 mm 4.1 x 5 inch  150</p>
<p>1.  Edding 69 2.  Applique 1 3.  Applique 2 4.  Isacord 40 0015 5.  Isacord 40 0020 6.  Isacord 40 0015</p> 	<p>1.  Swarovski 0280 2.  Swarovski 0280</p> 
<p>12448-09_pw  121 x 161 mm 4.8 x 6.3 inch  8.265</p>	<p>21026-05_dw  118 x 202 mm 4.6 x 7.9 inch  9.309</p>
<p>1.  Edding 10 2.  Edding 2 3.  Edding 8 4.  Edding 1</p> 	<p>1.  Edding 9 2.  Isacord 40 0020</p> 
<p>12448-11_cr  84 x 124 mm 3.3 x 4.9 inch  174</p>	<p>12448-08_pw  119 x 177 mm 4.7 x 7 inch  4.540</p>
<p>1.  Swarovski 0280 2.  Swarovski 0280 3.  Swarovski 0280</p> 	<p>1.  Edding 7</p> 
<p>21022-13_dw  106 x 193 mm 4.2 x 7.6 inch  15.285</p>	<p>Be700121  128 x 128 mm 5 x 5 inch  2.183</p>
<p>1.  Edding 34 2.  Edding 68 3.  Edding 6 4.  Applique 1 5.  Applique 2 6.  Isacord 40 2640 7.  Applique 1 8.  Applique 2 9.  Isacord 40 1352 10.  Isacord 40 1600 11.  Isacord 40 4111 12.  Isacord 40 4103 13.  Isacord 40 0017 14.  Isacord 40 2830</p> 	<p>1.  Isacord 40 3600 2.  Isacord 40 1703</p> 

Be700122  119 x 37 mm
4.7 x 1.5 inch  4.124

1.  Isacord 40 5833





Be700123  113 x 206 mm
4.4 x 8.1 inch  6.090

1.  Punch 0004
2.  Punch 0007










Be700124  141 x 134 mm
5.6 x 5.3 inch  6.184

1.  Isacord 40 2300
2.  Isacord 40 3901



Be790906  192 x 196 mm
7.6 x 7.7 inch  21.054

1.  Edding 8
2.  Edding 3
3.  Edding 5
4.  Edding 34
5.  Edding 69
6.  Edding 10
7.  Edding 5
8.  Edding 9
9.  Edding 11
10.  Edding 65
11.  Edding 12



Be790905  104 x 227 mm
4.1 x 8.9 inch  21.349

1.  Edding 34
2.  Edding 12
3.  Edding 16
4.  Edding 10
5.  Edding 1



Be790903  181 x 293 mm
7.1 x 11.5 inch  11.366

1.  Edding 19



Be790901  182 x 252 mm
7.1 x 9.9 inch  38.392

1.  Edding 34
2.  Edding 9
3.  Edding 33
4.  Edding 68
5.  Edding 1









Be790909  167 x 322 mm
6.6 x 12.7 inch  20.162

1.  Edding 7







Dw05  105 x 94 mm
4.1 x 3.7 inch  13.334

1.  Isacord 40 2022
2.  Cut 0001
3.  Cut 0002
4.  Cut 0003
5.  Cut 0004
6.  Isacord 40 2022



Dw10  184 x 184 mm
7.3 x 7.3 inch  5.939

1.  Cut 0001
2.  Cut 0002
3.  Cut 0003
4.  Cut 0004



Index

A

Activate/deactivate function.....	27
Adjusting the hoop.....	56
Adjusting the Presser Foot Pressure.....	40
Adjusting the presser position via the knee lifter of the Free Hand System.....	38
Adjusting the upper thread tension.....	51
Alphabets.....	107
Altering the embroidery motif size disproportionately.....	153
Altering the embroidery motif size proportionally.....	152
Altering the stitch density.....	154
Attaching the embroidery module.....	137
Attaching the hoop.....	145
Attaching the knee lifter.....	34

B

BERNINA Dual Feed.....	68
Buttonholes.....	110

C

Calibrating the Buttonhole foot No. 3A.....	63
Calibrating the display.....	62
Calling up Help.....	67
Calling up the Creative Consultant.....	67
Calling up the tutorial.....	67
Changing the color.....	163
Changing the needle.....	40
Changing the presser foot.....	38
Checking the firmware version.....	173
Child safety lock.....	67
Cleaning the feed dog.....	174
Cleaning the hook.....	175
Combination Mode.....	74, 159
Combining Embroidery Motifs.....	159
Cord.....	114

D

Decorative stitches.....	101
Display machine ID.....	65
Dispose of the machine.....	187

E

Embroidery file format.....	134
Embroidery test.....	134
Energy-saving Mode.....	67
Entering dealer data.....	64
Environmental Protection.....	12
Error messages.....	179
Explanation of symbols.....	13

F

Firmware	
Activate/deactivate function.....	27
Navigation.....	26
Setting values.....	27
Fitting the stitch plate.....	141
Foot Control	
Back-kick.....	35
Connecting.....	33
Free point positioning.....	158

I

Inserting the embroidery needle.....	139
Introduction.....	14

L

Lubricating the hook.....	176
---------------------------	-----

M

Maintenance and cleaning.....	174
Moving the hoop to the back.....	146
Moving the module for the Sewing Mode.....	146

N

Navigation.....	26
Needle Stop Up/Down (permanent).....	42
Needle up/down	
via Foot Control.....	35
Needle, Thread and Fabric.....	28
Needles overview.....	28
Needles, Threads.....	31



BERNINA recommends threads from *Mettler*[®]

BERNINA International AG | CH-8266 Steckborn Switzerland | www.bernina.com | © Copyright by BERNINA International AG

made to create **BERNINA**

1055835.008.04
2021-04 EN