

INSTRUCTION BOOK

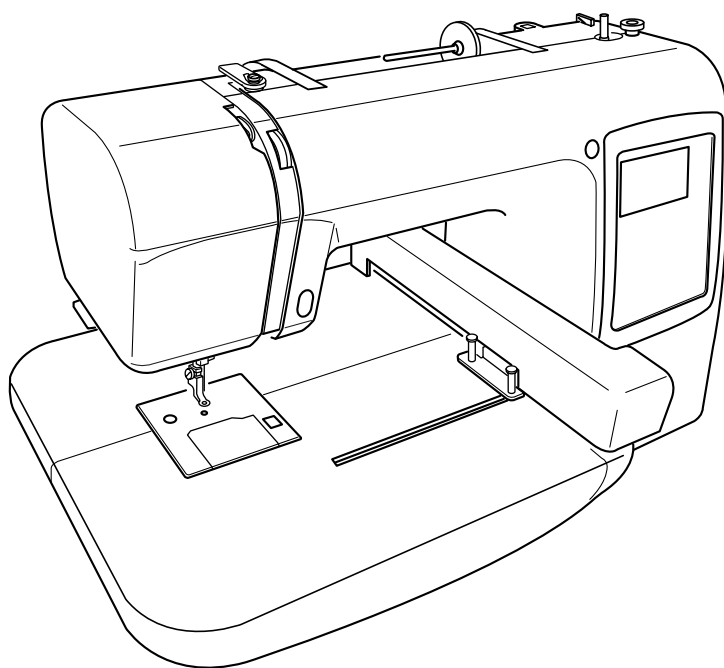

MC 200E

IMPORTANT SAFETY INSTRUCTIONS

This sewing machine is not a toy. Do not allow children to play with this machine.

The machine is not intended for use by children or mentally infirm persons without supervision.

This sewing machine is designed and manufactured for household use only.

Read all instruction before using this sewing machine.

DANGER — To reduce the risk of electric shock:

1. An appliance should never be left unattended when plugged in. Always unplug this sewing machine from the electric outlet immediately after using and before cleaning.
2. Do not reach for the appliance that has fallen into water. Unplug immediately.
3. Do not place or store appliance where it can fall or be pulled into a tub or sink. Do not place in or drop into water or other liquid.

WARNING — To reduce the risk of burns, fire, electric shock, or injury to persons:

1. Do not allow children to play with the machine. The machine is not intended for use by children or infirm persons without proper supervision.
Do not allow to be used as a toy. Close attention is necessary when this sewing machine is used by or near children.
2. Use this appliance only for its intended use as described in this owner's manual.
Use only attachments recommended by the manufacturer as contained in this owner's manual.
3. Never operate this sewing machine if it has a damaged cord or plug, if it is not working properly, if it has been dropped or damaged, or dropped into water.
4. Never operate the appliance with any air opening blocked. Keep ventilation opening of this sewing machine and foot controller free from accumulation of lint, dust and loosen cloth.
5. Never drop or insert any object into any opening.
6. Do not use outdoors.
7. Do not operate where aerosol (spray) products are being used or where oxygen is being administered.
8. To disconnect, turn all controls to the off ("O") position, then remove plug from outlet.
9. Do not unplug by pulling on cord. To unplug, grasp the plug, not the cord.
10. Keep fingers away from all moving parts. Special care is required around the sewing machine needle.
11. Always use the proper needle plate. The wrong plate can cause the needle to break.
12. Do not use bent needles.
13. Do not pull or push fabric while stitching. It may deflect the needle causing it to break.
14. Switch this sewing machine off ("O") when making any adjustment in the needle area, such as threading the needle, changing the needle, threading the bobbin or changing the presser foot, and the like.
15. Always unplug this sewing machine from the electrical outlet when removing covers, lubricating, or when making any other adjustments mentioned in this owner's manual.

SAVE THESE INSTRUCTIONS

The design and specifications are subject to change without a prior notice.



Please note that on disposal, this product must be safely recycled in accordance with relevant National legislation relating to electrical/electronic products. If in doubt please contact your retailer for guidance. (European Union only.)

Table of contents

Name of parts	2	Saving the file	39
Standard accessories	3	Saving in internal memory	39
GETTING READY TO SEW		Name of file	39-40
Connecting the power supply	4	Saving in USB memory (optional)	41
For your safety	4	Creating a new folder	42
Polarized plug	4	Opening a file from the internal memory	43
Start/stop button	5	Deleting a file	43
Presser foot lifter	5	Opening a file from USB memory (optional)	44
Winding the bobbin	6	CARE AND MAINTENANCE	
Removing the bobbin	6	Cleaning the hook race	45
Setting the spool of thread	6	Assembling the hook race	45
Additional spool pin	6	TROUBLESHOOTING	
Winding the bobbin	7	DESIGN CHARTS	48-50
Inserting the bobbin	8		
Threading the machine	9		
Needle threader	10		
Drawing up the bobbin thread	11		
Changing the needle	12		
Adjusting the thread tension	13		
Balanced thread tension	13		
When the needle thread tension is too tight	13		
When the needle thread tension is too loose	13		
Adhesive (iron-on) stabilizer	14		
Stabilizers	14		
Types of stabilizer	14		
Usage	14		
Template	14		
KEY OPERATIONS			
Adjusting the brightness of LCD screen	15		
Function panel	15-16		
Setting mode	17		
Machine settings	17-20		
HELP key	21		
Setting the fabric in the embroidery hoop	22		
Attaching the embroidery hoop to the machine	23		
Selecting built-in designs	24		
Ready to sew screen	24		
Color list screen	24		
Starting to sew embroidery	25-26		
When the upper thread has broken or run out while sewing	26		
Lettering embroidery	27-30		
Selecting fonts	27		
Entering characters	27		
To enter lettering	28		
Ready to sew screen	29		
Color change	29		
Placement of lettering embroidery	29		
Maximum number of characters	29		
To view a long lettering	30		
Deleting a letter	30		
Inserting a letter	30		
Editing mode	31-38		
Selecting the hoop	31		
Selecting the pattern to edit	32		
Magnifier key	33		
Flipping the pattern	33		
Resizing the pattern	34		
Rotating the pattern	34		
Combining patterns	35-38		

Name of parts

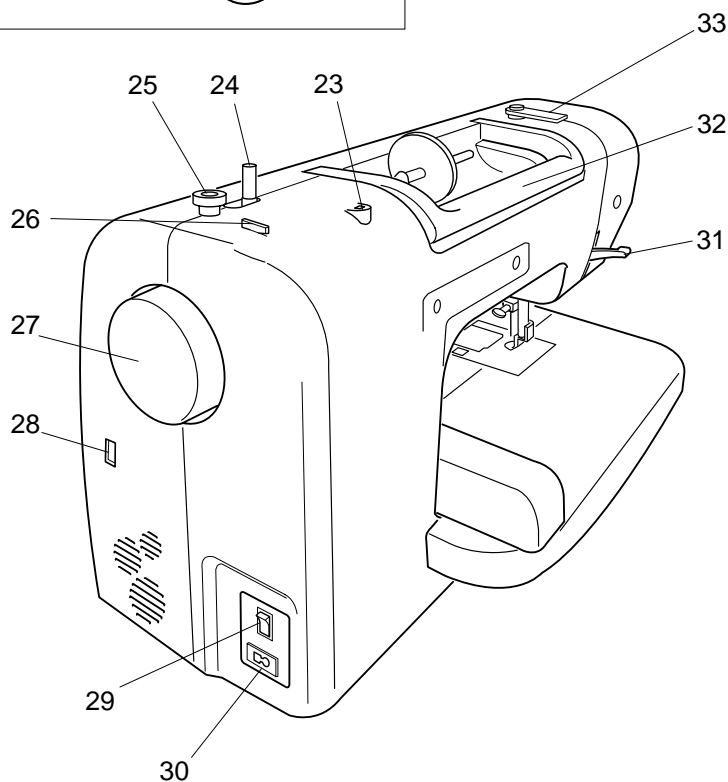
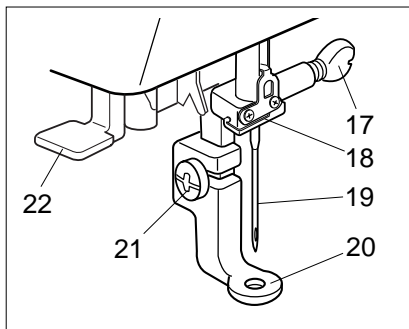
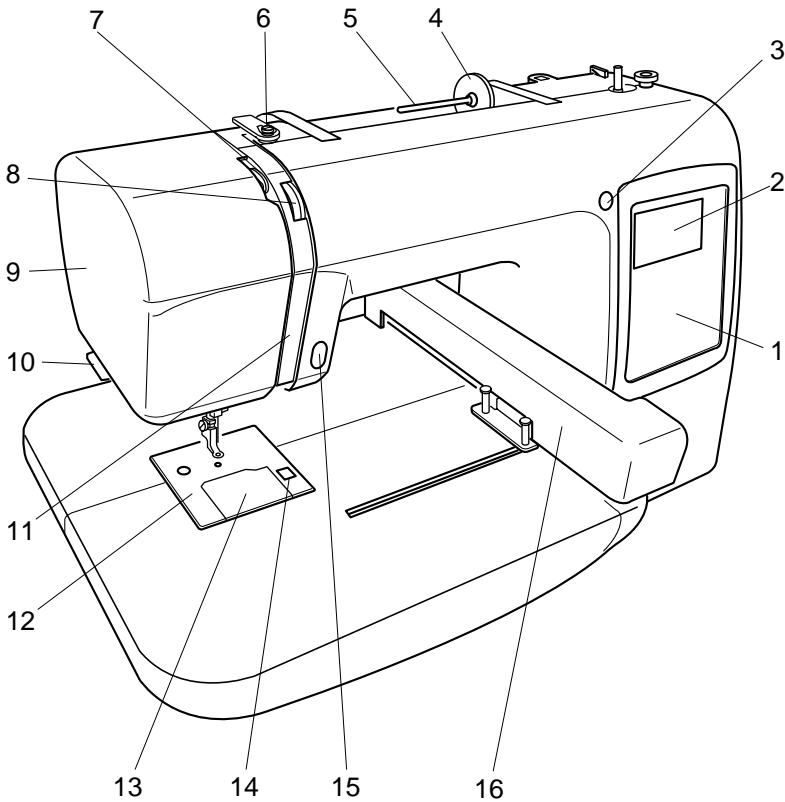

- 1 Function panel
- 2 LCD screen
- 3 LCD brightness adjusting dial
- 4 Spool holder (large)
- 5 Spool pin
- 6 Bobbin thread guide
- 7 Thread take-up lever
- 8 Thread tension dial
- 9 Face plate
- 10 Thread cutter & thread holder
- 11 Thread guide plate
- 12 Needle plate
- 13 Hook cover plate
- 14 Hook cover plate release button
- 15 Start/stop button
- 16 Carriage
- 17 Needle clamp screw
- 18 Needle bar thread guide
- 19 Needle
- 20 Presser foot
- 21 Setscrew
- 22 Needle threader
- 23 Hole for additional spool pin
- 24 Bobbin winder spindle
- 25 Bobbin winder stopper
- 26 Thread cutter
- 27 Handwheel
- 28 USB socket
- 29 Power switch
- 30 Machine socket
- 31 Presser foot lifter
- 32 Carrying handle
- 33 Thread guide cover

Standard Accessories

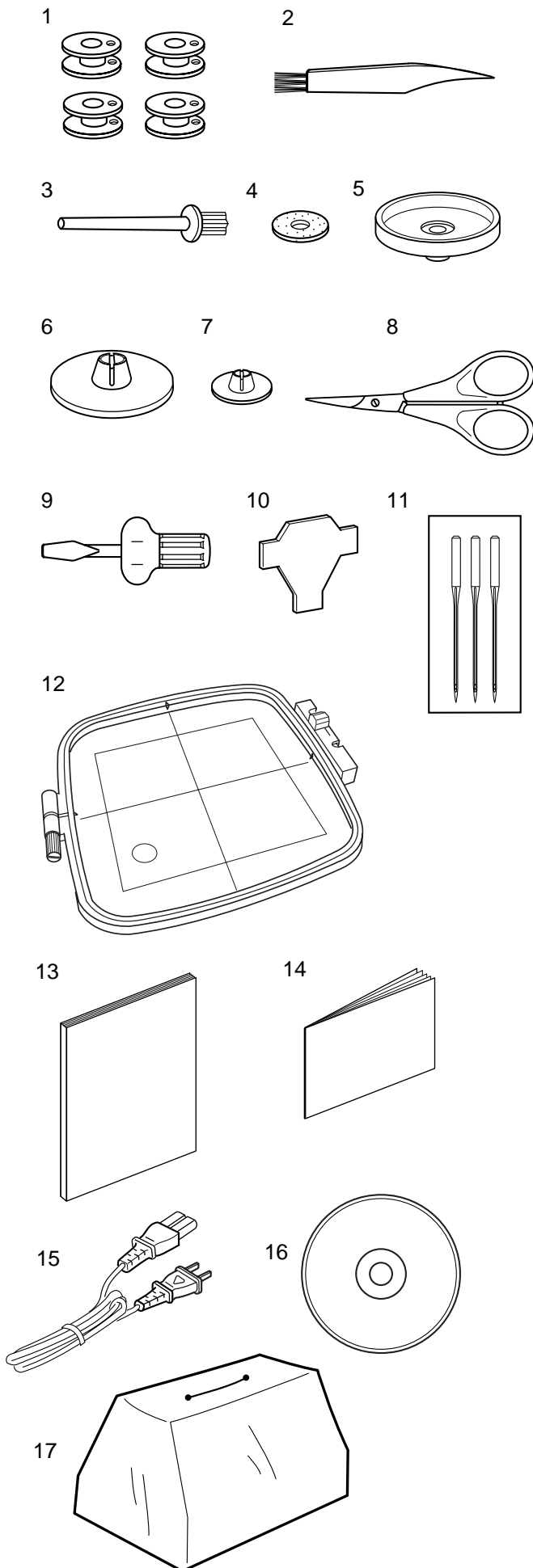

- 1 Bobbin
- 2 Lint brush
- 3 Additional spool pin
- 4 Felt
- 5 Spool stand
- 6 Spool holder (Large)
- 7 Spool holder (Small)
- 8 Scissors
- 9 Screwdriver
- 10 Screwdriver
- 11 Set of needles
- 12 Embroidery hoop
- 13 Instruction book
- 14 Template sheets
- 15 Power supply cord
- 16 Instructional movie CD
- 17 Soft cover

GETTING READY TO SEW

Connecting the power supply

Turn off the power switch and insert the machine plug into the machine socket.

Insert the power supply plug into the wall outlet and turn the power switch on.

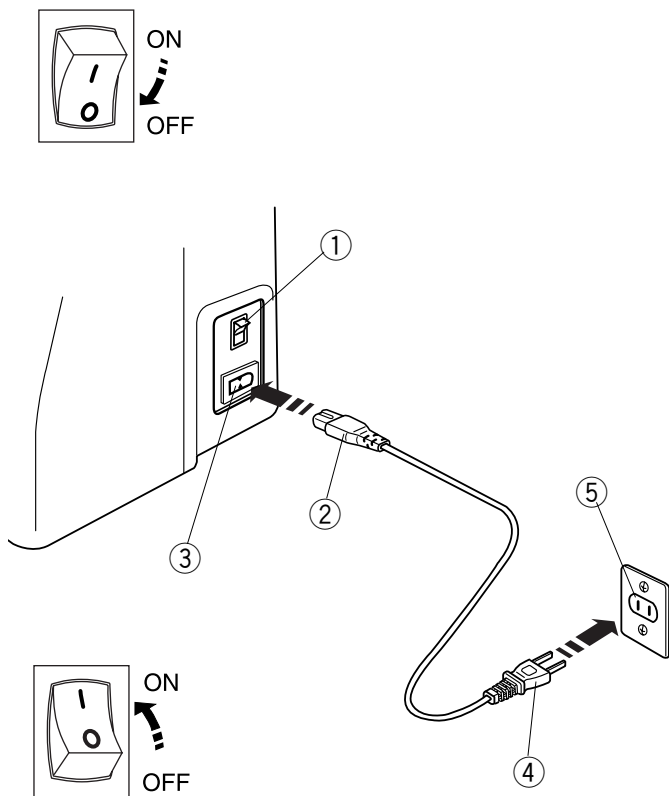

- ① Power switch
- ② Machine plug
- ③ Machine socket
- ④ Power supply plug
- ⑤ Wall outlet

NOTE:

After turning on the power, it takes approximately ten seconds for boot-up.

For Your Safety

While in operation, always keep your eyes on the sewing area, and do not touch any moving parts such as the thread take-up lever, handwheel or needle.

Always turn off the power switch and unplug the power supply:

- when leaving the machine unattended.
- when attaching or removing parts.
- when cleaning the machine.

Polarized plug (for U.S.A and Canada only)

The symbol "O" of a switch indicates the "off" position of a switch.

For appliances with a polarized plug (one blade wider than the other). To reduce the risk of electric shock, this plug is intended to fit in a polarized outlet only one way. If it does not fit fully in the outlet, reverse the plug. If it still does not fit, contact a qualified electrician to install the proper outlet. Do not modify the plug in any way.

Start/stop button

Press this button to start or to stop the machine.

- ① Start/stop button

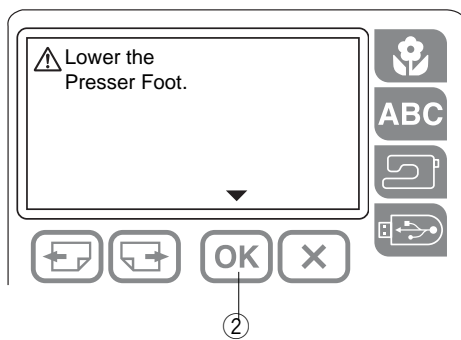
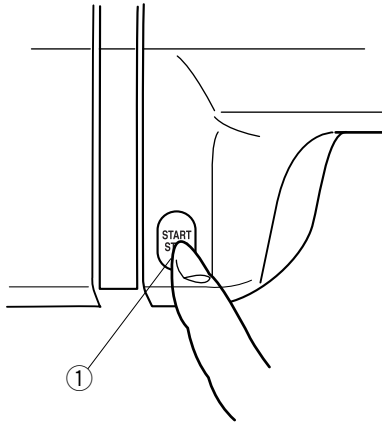

NOTE:

If you press the start/stop button without lowering the presser foot, a warning message appears on the LCD screen.

Lower the presser foot and press the OK key to return to the previous display.

- ② OK key

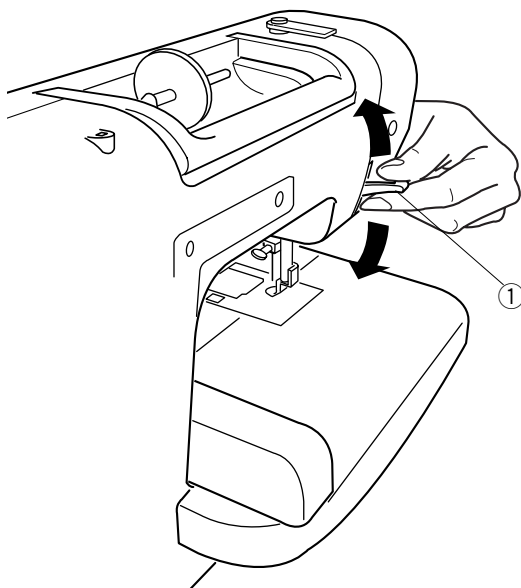

Presser foot lifter

- ① Presser foot lifter

The presser foot lifter raises and lowers the presser foot. You can raise it higher than the normal up position for easy removal of the presser foot or to set the embroidery hoop.

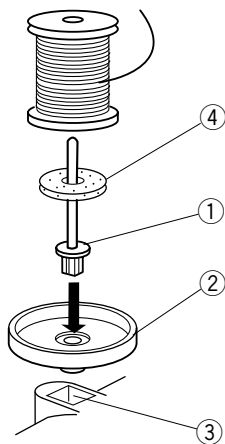
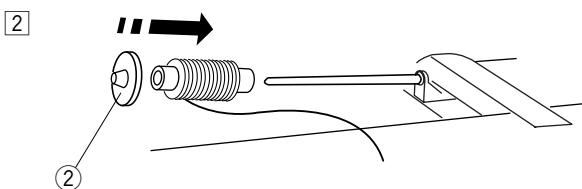
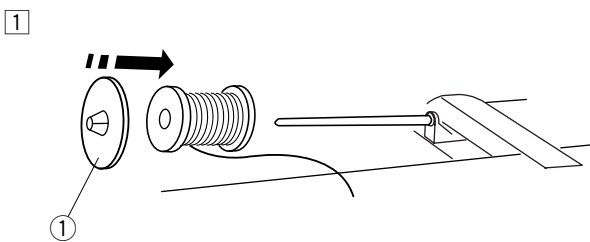
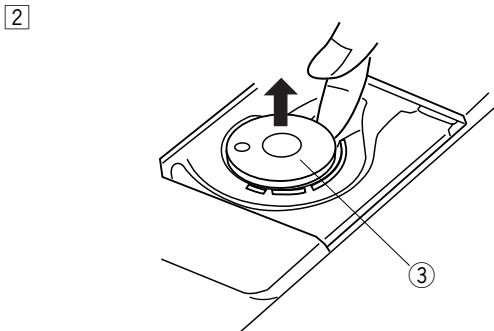
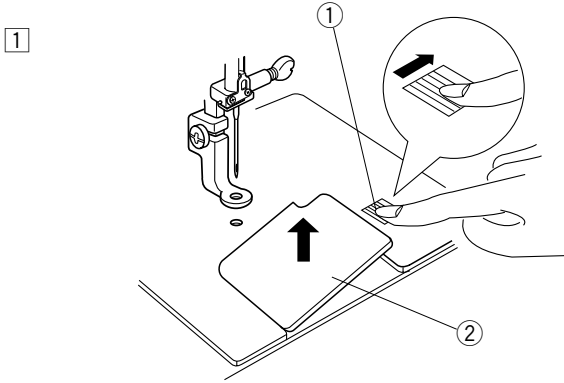

Winding the bobbin

Removing the bobbin

- 1 Slide the hook cover plate release button to the right, and remove the hook cover plate.

- 2 Lift out the bobbin from the bobbin holder.

- 1 Hook cover plate release button
- 2 Hook cover plate
- 3 Bobbin

Setting the spool of thread

- 1 Place the spool of thread on the spool pin with the thread coming off the spool as shown. Attach the large spool holder, and press it firmly against the spool of thread.

- 1 Large spool holder

- 2 Use the small spool holder to hold narrow or small spools of thread.

- 2 Small spool holder

Additional spool pin

Use the additional spool pin when you need to wind the bobbin without unthreading the machine while working on an embroidery.

Insert the additional spool pin into the spool stand and then into the hole beside the horizontal spool pin. Place the felt on the spool pin and place a spool of thread on it as shown.

- 1 Additional spool pin
- 2 Spool stand
- 3 Hole
- 4 Felt

Winding the bobbin

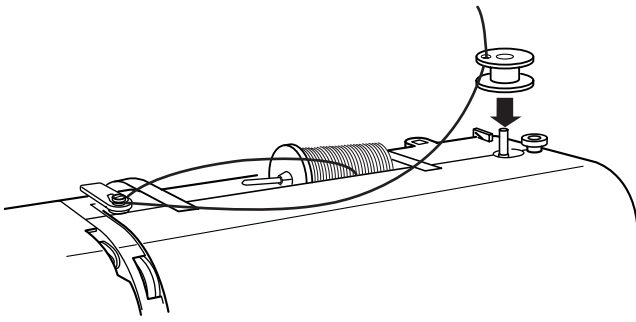

1

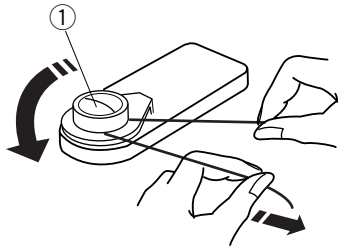

1 Guide the thread around the bobbin winder thread guide while holding the thread with both hands.

① Bobbin winder thread guide

2

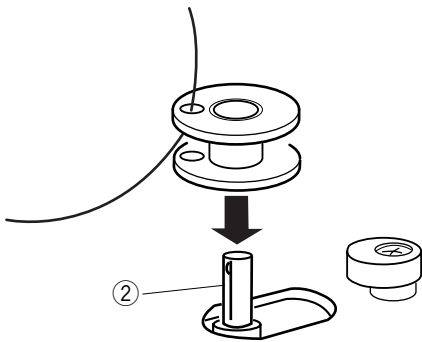

2 Thread through the hole in the bobbin from the inside to the outside. Put the bobbin on the bobbin winder spindle.

② Bobbin winder spindle

3

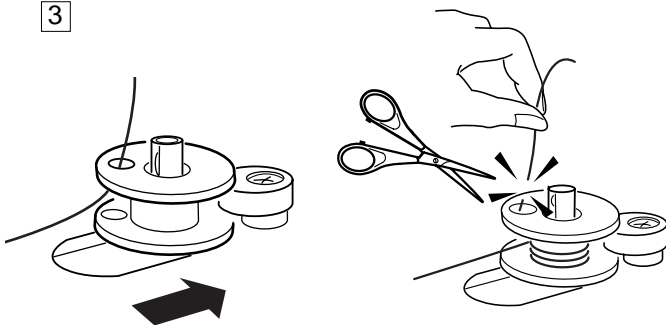

3 Push the spindle to the right. Press the start/stop button while holding the end of the thread. Stop the machine after the bobbin is wound a few layers. Cut the thread close to the hole in the bobbin.

4

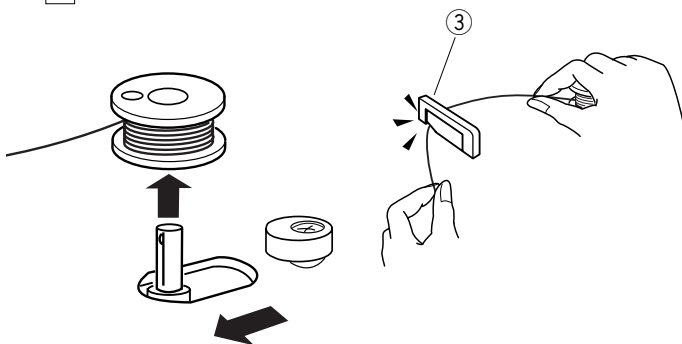

4 Press the start/stop button again. When the bobbin is fully wound it will stop automatically. Press the start/stop button to stop the machine then return the bobbin winder spindle to the left. Remove the bobbin and cut the thread with the bobbin thread cutter.

③ Bobbin thread cutter

NOTE:

Do not move the bobbin winder spindle while the machine is running. For safety purposes, the motor will stop automatically after running for two minutes.



CAUTION



Use the Janome plastic bobbin for horizontal hook machines (marked with J). Using other bobbins, such as prewound paper bobbins, may cause stitching problems or damage the bobbin case.

Inserting the bobbin

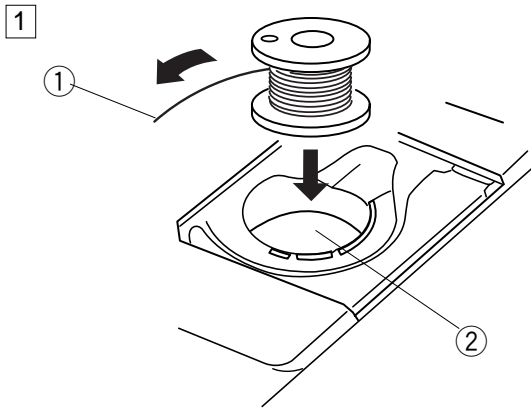

- 1 Place the bobbin in the bobbin holder with the thread running off in a counterclockwise direction.
 - 1 Thread
 - 2 Bobbin holder

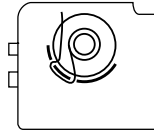

* Refer to the threading chart shown on the hook cover plate.

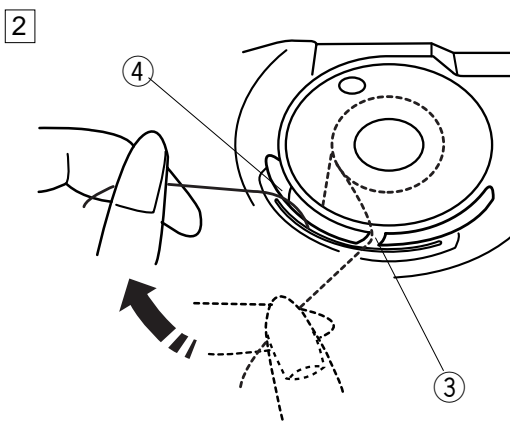

- 2 Guide the thread into the notch on the front of the bobbin holder. Draw the thread to the left, sliding it between the tension spring blades.
 - 3 Front notch

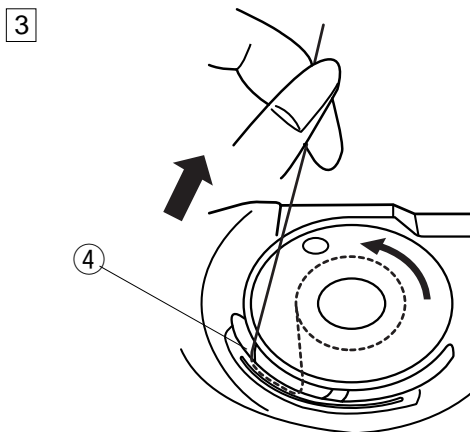

- 3 Continue to draw the thread lightly until the thread slips into the side notch. Pull out about 10 cm (4") of thread to the rear.
 - 4 Side notch

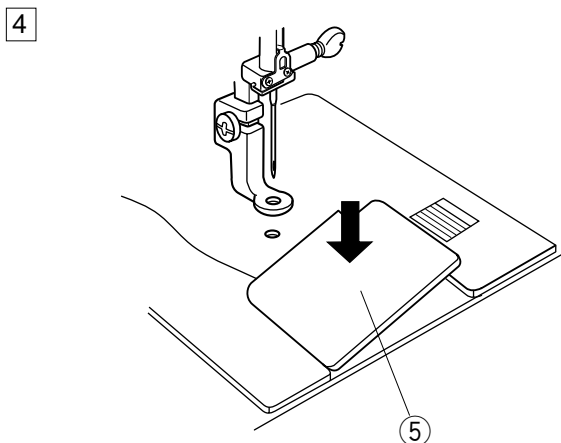

- 4 Reattach the hook cover plate.
 - 5 Hook cover plate

Threading the machine

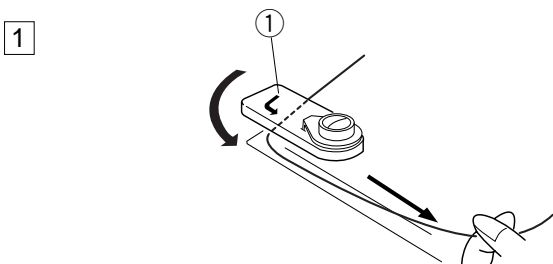
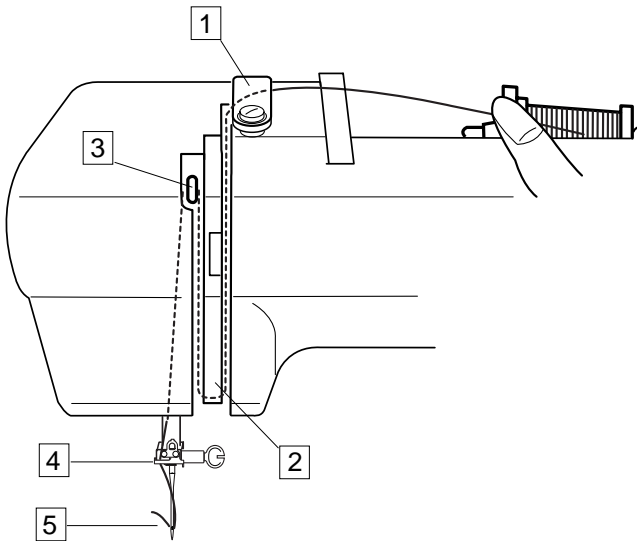

- 1 Raise the presser foot lifter. Turn the handwheel to bring the needle to its highest position. Draw the thread around and under the thread guide while holding the thread at the spool. Then draw the thread down through the right channel of the thread tension dial.

① Thread guide

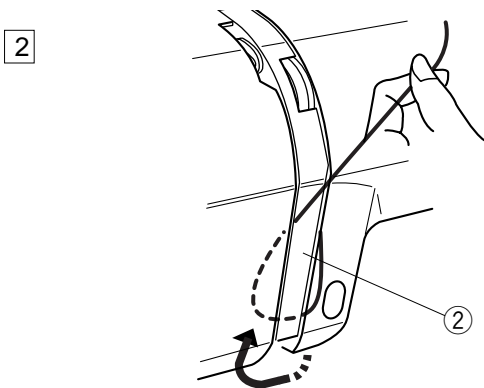

- 2 Firmly draw the thread around the thread guide plate and up to the thread take-up lever.

② Thread guide plate

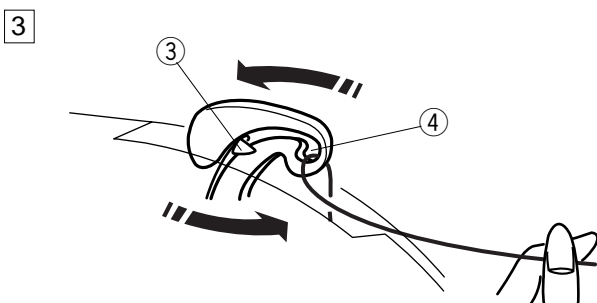

- 3 Slip the thread through the slit and down into the eye of the take-up lever as shown. Draw the thread down through the left channel.

③ Slit

④ Eye of the take-up lever

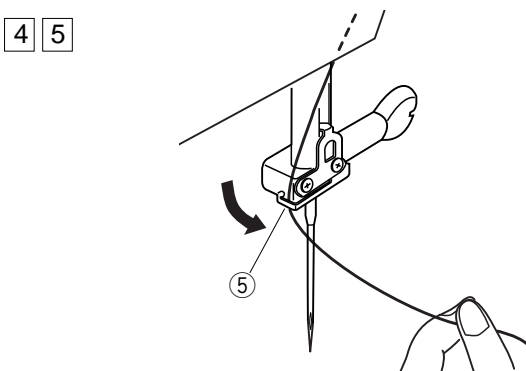

- 4 Slip the thread behind the lower thread guide from the right.

- 5 Slip the thread in the needle bar thread guide from the left.

⑤ Needle bar thread guide

Thread the needle from front to back by hand or use the built-in needle threader.

NOTE:

Refer to page 10 for built-in needle threader.

Needle threader

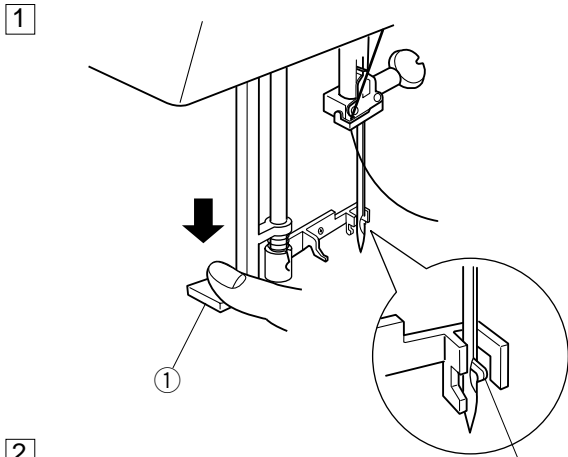

- 1 Lower the presser foot. Depress the needle threader knob as far as it will go. The hook comes out through the needle eye from behind.
 - 1 Needle threader knob
 - 2 Hook

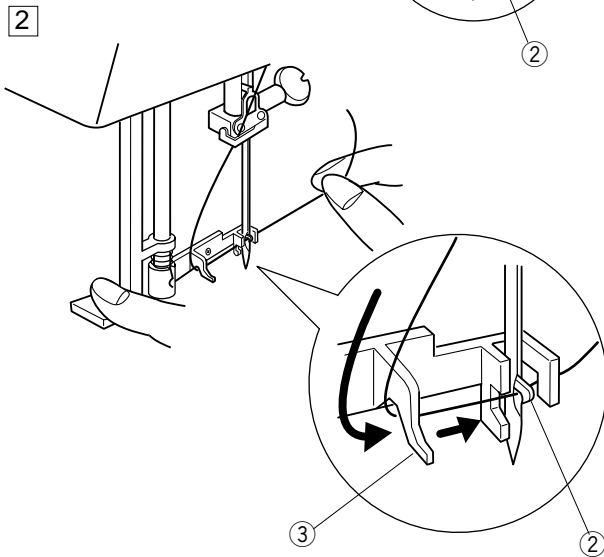

- 2 Draw the thread down around the threader guide and under the hook.
 - 3 Threader guide

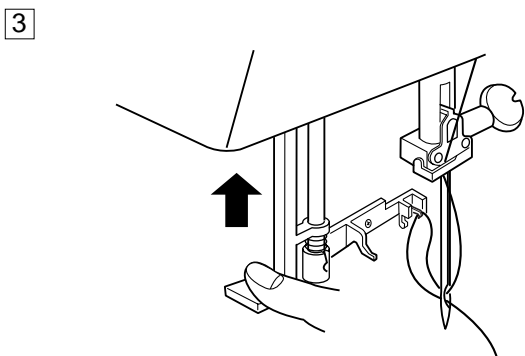

- 3 Release the threader knob slowly while holding the thread end with your hand. A loop of the thread is pulled up through the needle eye.

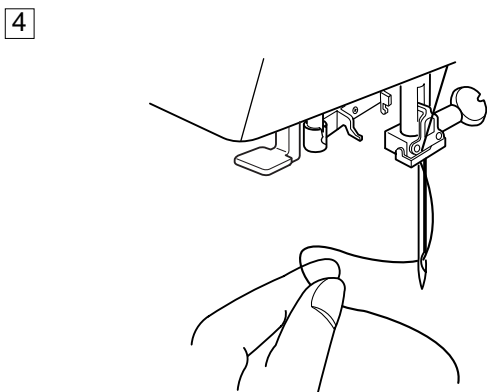

- 4 Remove the loop from the threader and pull out the thread end from the needle eye.

NOTE:

The needle threader works well with the threads #50-90 and needles #11-14, as well as the blue tip needles.

Drawing up the bobbin thread

1

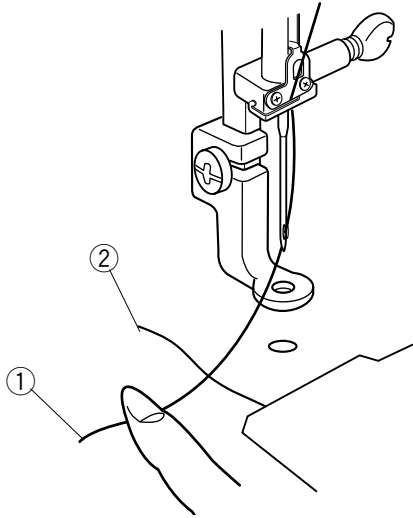

1 Raise the presser foot lifter. Hold the needle thread with your finger.

- ① Needle thread
- ② Bobbin thread

2

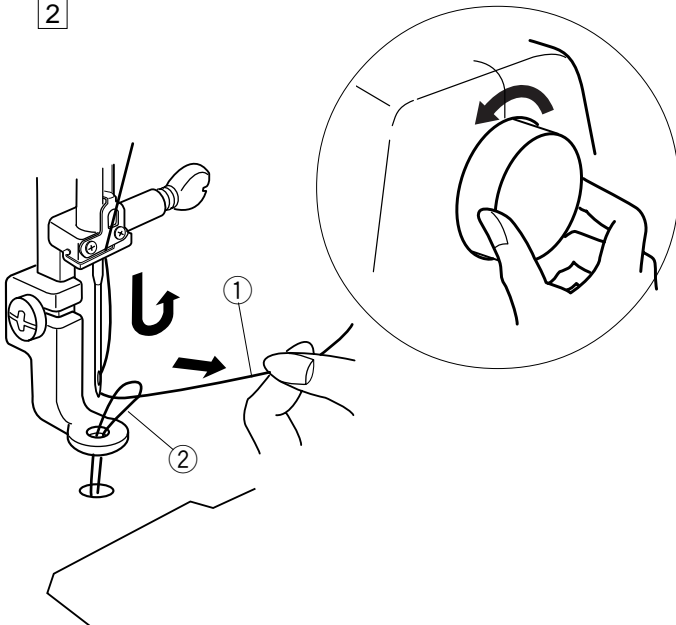

2 Turn the handwheel one complete turn towards you. Draw the needle thread to bring up a loop of the bobbin thread.

3

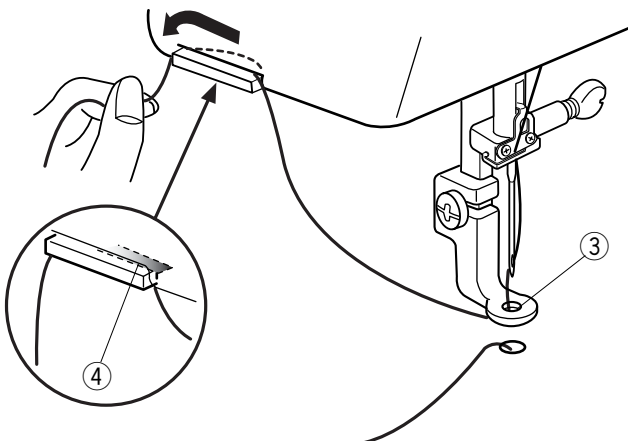

3 Pass the needle thread through the hole in the embroidery foot and draw it up to the thread holder leaving an inch of free thread.

- ③ Hole
- ④ Thread holder

Changing the needle

CAUTION

Always make sure to turn the power switch off and disconnect the machine from the power supply before changing the needle.

1

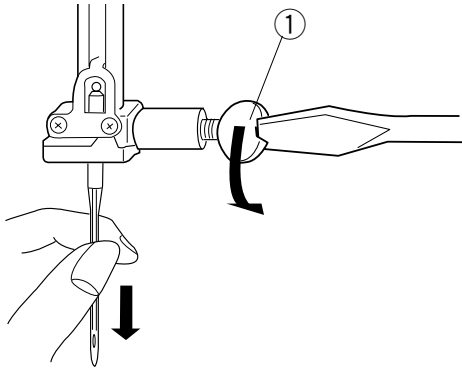

- 1 Turn off the power switch. Raise the needle by turning the handwheel and lower the presser foot. Loosen the needle clamp screw by turning it counterclockwise. Remove the needle from the clamp.

2

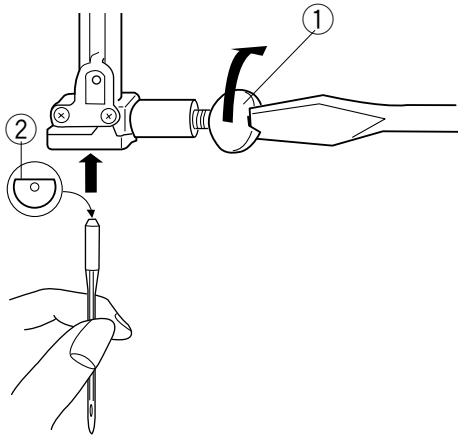

- 2 Insert a new needle into the needle clamp with the flat side of the needle to the rear.
 - 1 Needle clamp screw
 - 2 Flat side of the needle

When inserting the needle into the needle clamp, push it up as far as it will go and tighten the needle clamp screw firmly.

3

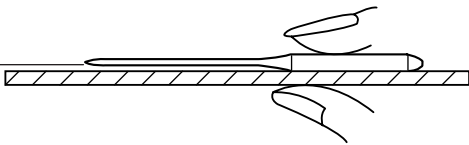

To check needle straightness, place the flat side of the needle onto something flat (a needle plate, glass etc.) The gap between the needle and the flat surface should be consistent.

- 3 Gap

Never use a blunt needle.

NOTE:

Use size 11 blue tipped needles for fine fabrics. For medium to heavy weight fabrics, use size 14 needles.

Adjusting the thread tension



Balanced thread tension

A small amount of needle thread shows on the wrong side of the fabric.

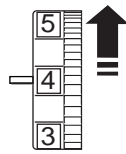
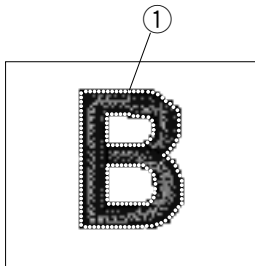

When the needle thread tension is too tight

The bobbin thread shows on the right side of the fabric. Reduce the tension by turning the tension dial to a lower number.

① Bobbin thread

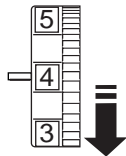
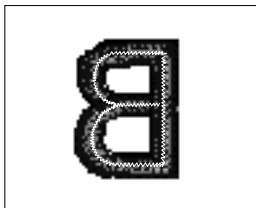

When the needle thread tension is too loose

The needle thread forms loops and the stitches look shaggy.

Increase the tension by turning the dial to a higher number.

Stabilizers

To obtain the best quality embroidery, it is important to use stabilizers.

Types of stabilizer

Tear-away Stabilizer is made from a fiber that will tear easily. Use tear-away stabilizers for stable woven fabrics. After stitching, tear away the stabilizer so that the small portion left in the back of the stitching will not affect the wear.

Iron-on Stabilizer is an adhesive type stabilizer for knits and all kinds of unstable fabrics. Fuse it to the wrong side of fabric with an iron.

Cut-away Stabilizer is a non-woven fabric that does not tear. Cut the excess portion after stitching. Use cutaway stabilizers for knits and all kinds of unstable fabrics.

Water Soluble Stabilizer will dissolve in water. Use this stabilizer for cutwork or lace embroidery, and also for the right side of looped fabrics such as toweling to avoid loops coming through the embroidery.

Sticky Stabilizer is a sticky paper used for securing a small fabric or work that cannot be secured in the hoop. It is also used for velvet and other napped fabric that would be permanently marked by the hoop.

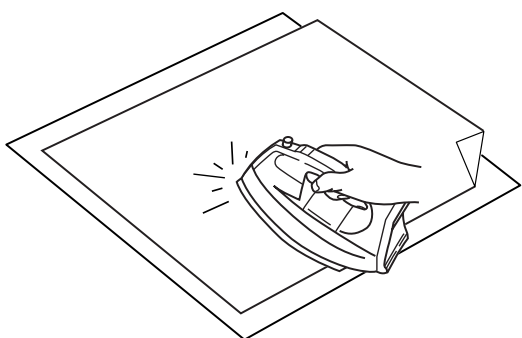

Adhesive (Iron-on) stabilizer

Place the wrong side of fabric and the glossy side of the stabilizer together. Fold up a corner of the stabilizer and fuse it with an iron.

NOTES:

Fold up a corner of the stabilizer, to make it easier to peel off the excess stabilizer after stitching.
Ironing temperatures vary depending on the type of adhesive type stabilizer being used.

Usage

The stabilizer should be attached to the wrong side of fabric. More than one layer may be required.

Felt or stable fabrics do not need to be stabilized and you may embroider directly on them.

For firm fabrics, you may place a thin paper under the fabric.

The non-adhesive type should be used when embroidering fabric, which cannot be ironed or for sections, which are difficult to iron.

Cut the stabilizer larger than the embroidery hoop and set it on the hoop so that the entire piece is fastened within the hoop to prevent looseness of the fabric.

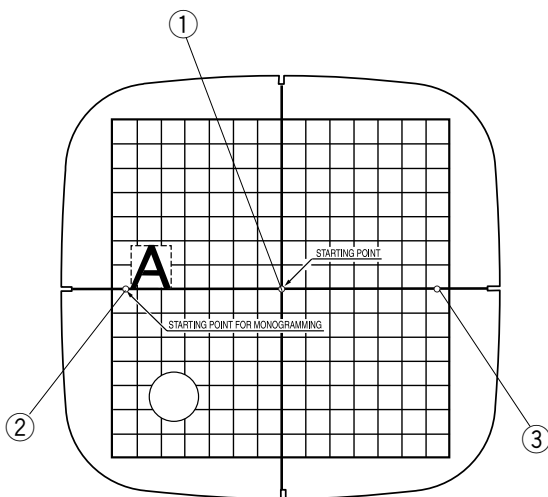

Template

When positioning the fabric into the hoop, use the template to align the centerlines on the fabric with the center of the hoop. First mark the centerlines on the fabric and place the fabric on the outer hoop. Place the inner hoop and template over the fabric and adjust the fabric placement.

- ① Center point for embroidery and center justified lettering embroidery
- ② Leftmost point for left justified lettering embroidery
- ③ Rightmost point for right justified lettering embroidery

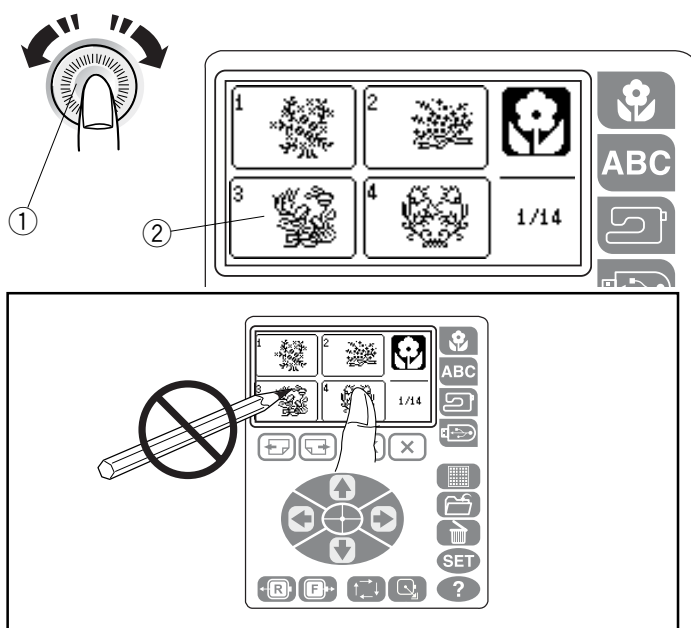

KEY OPERATIONS

Adjusting the brightness of the LCD screen

- ① LCD brightness adjustment dial
- ② LCD screen

⚠ CAUTION:

Do not press the surface of the LCD Screen or function panel with a hard or sharp object such as a pencil, screwdriver or the like.

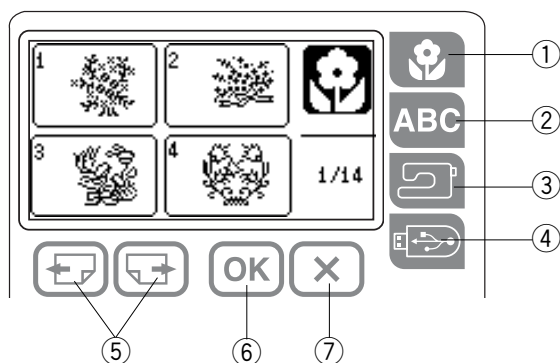

Function panel

- ① **Built-in design key**
Press this key to display the pattern selection window for the built-in designs. The LCD screen displays up to 4 patterns. Press the page keys to show the next or previous 4 patterns. Press the icon key to select the desired pattern. The LCD screen shows the ready to sew window.
- ② **Lettering key**
Press this key to select one of the 3 fonts for the lettering embroidery or border designs. To enter the characters, press the letter key until the desired character appears on the LCD screen.
- ③ **Internal memory key**
Press this key to open the pattern file stored in the machine's internal memory.
- ④ **USB memory key**
Press this key to open the pattern file stored in the USB memory.
- ⑤ **Page keys**
Press the next page key to display the next page and press the previous page key to go back to the previous page.
- ⑥ **OK key**
Press this key to confirm the setting and return to the previous window.
- ⑦ **Exit key**
Press this key to close the current window and return to the previous display.

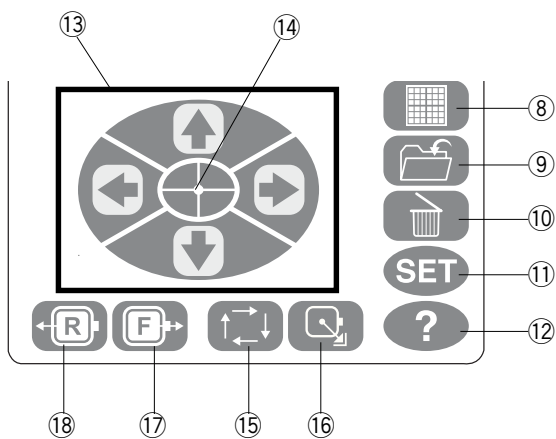

- ⑧ **Editing key**
Press this key to open the editing window. You can resize, rotate, flip and combine the pattern to create your own original embroidery design.
- ⑨ **File save key**
Press this key to save the lettering or edited design as a file.
- ⑩ **Delete key**
Press this key to delete the selected pattern.
- ⑪ **SET key**
Press this key to open the custom setting windows. You can set the machine functions to your preference (See page 17-20).
- ⑫ **Help key**
Press this key to view the step by step illustrated instructions of the following basic operations:
 1. Changing needle
 2. Inserting the bobbin
 3. Threading the machine
 4. Winding the bobbin
- ⑬ **Jog keys**
Press one of the 4 keys to move the hoop in the direction of the arrow on the key. In the editing mode, press these keys to move the selected pattern in the editing window.
- ⑭ **Centering key**
Press this key to move the hoop to the center.
- ⑮ **Trace key**
Press this key to trace the embroidery pattern without stitching.
- ⑯ **Carriage return key**
Press this key to return the carriage to the home position.
- ⑰ **Stitch forward key**
Press this key to move the hoop forward. The hoop will move forward 10 stitches each time you press this key.
- ⑱ **Stitch back key**
Press this key to move the hoop backward. The hoop will move backward 10 stitches each time you press this key.

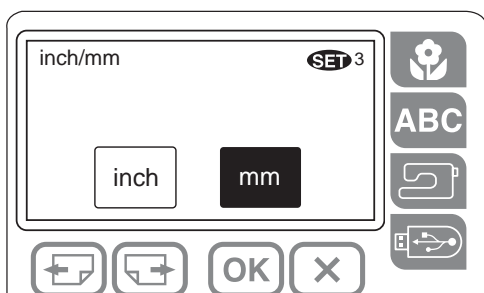
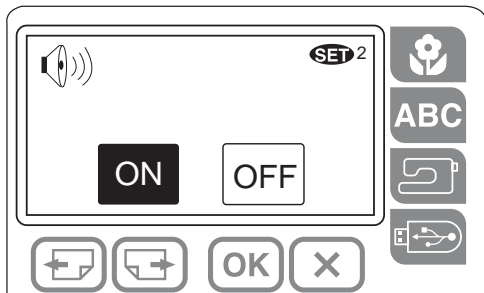
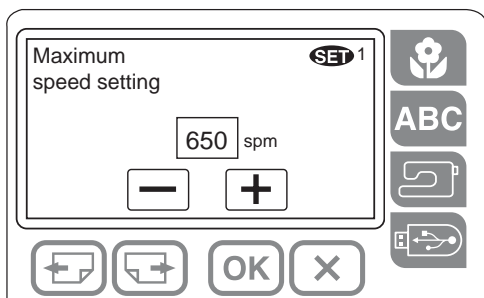
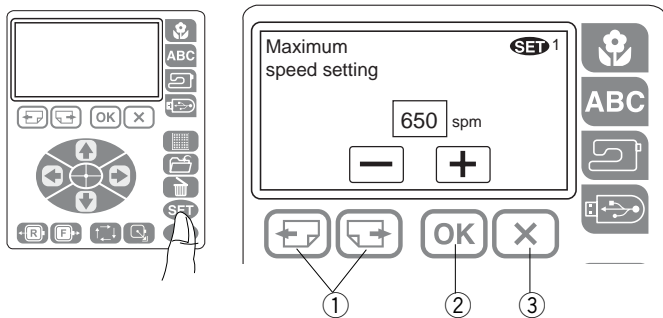

Setting mode

Machine settings

Pressing the **SET** key will open the custom setting windows. You can set the following 8 functions to your preference.

- ① **Page keys**
Press the next page key to display the next page and press the previous page key to go back to the previous key.
- ② **OK key**
Press the OK key to confirm the setting and return to the previous window.
- ③ **Exit key**
Press the Exit key to return to the previous window without changing the setting.

1. Maximum speed

The maximum sewing speed can be set from 400 to 650 spm.
The default setting is 650 spm.

Press the – key to reduce the maximum sewing speed.
Press the + key to increase the maximum sewing speed.

NOTE:

Reduce the sewing speed when sewing small embroidery patterns, as distortions tend to occur at high speeds.

2. Buzzer sound

The buzzer sound can be turned ON or OFF.
The default setting is ON.

Press the ON key to switch on the buzzer sound.
Press the OFF key to switch off the buzzer sound.

3. Inch/millimeter

You can set your machine's measuring unit to either inches or millimeters.
The default unit setting is millimeters.
Press the **inch** or **mm** key to select the preferred unit.

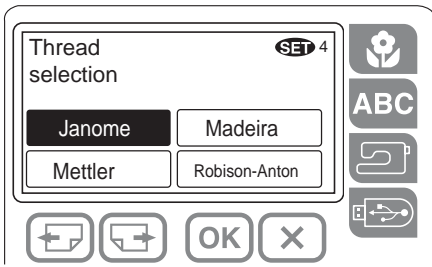

4. Thread selection

There are four brands of embroidery threads to choose from. Press the corresponding key of the thread you wish to use. The color code of the selected brand will be shown on the embroidery screen.

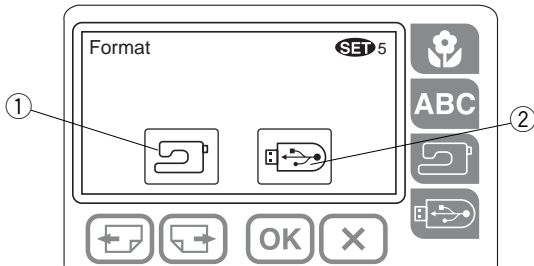

5. Formatting the memory

If the internal memory or USB memory does not function due to damage to the memory bank, you need to re-enable it by formatting the memory.

To format the memory, select the memory location by pressing the corresponding icon key and press OK key.

- ① Built-in memory
- ② USB memory

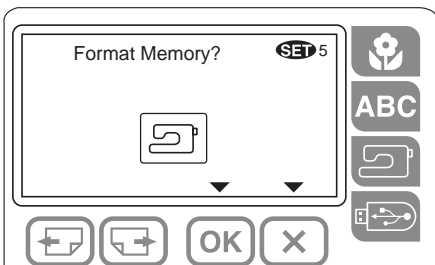

NOTE:

Formatting will erase all data stored in the memory.

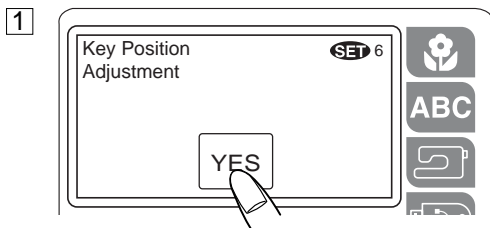

6. Key position adjustment

If you think the touch panel keys are unaligned, you can correct it in the key position adjustment window.

- ① Press the YES key.

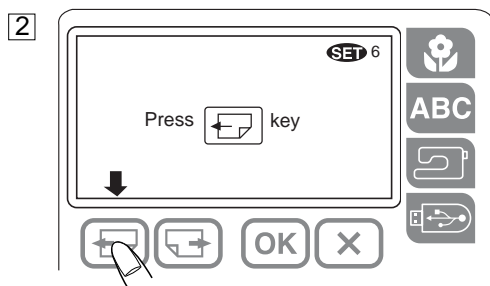

- ② Follow the guidance that appears in the window. Press the previous page key.

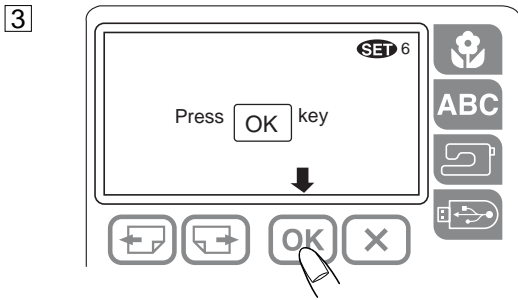

3 Press the OK key.

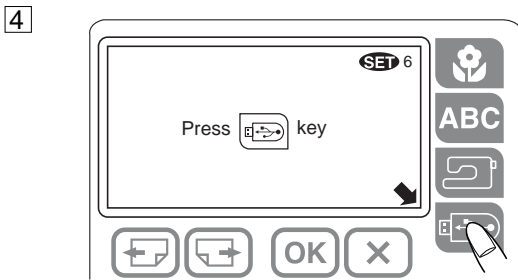

4 Press the USB file open key.

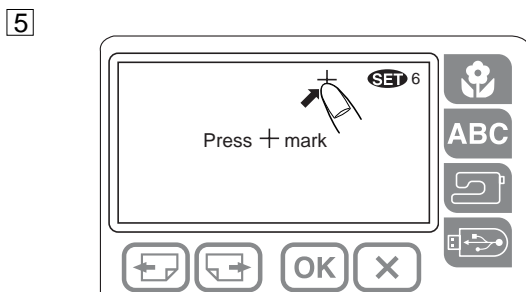

5 Press the cross mark.

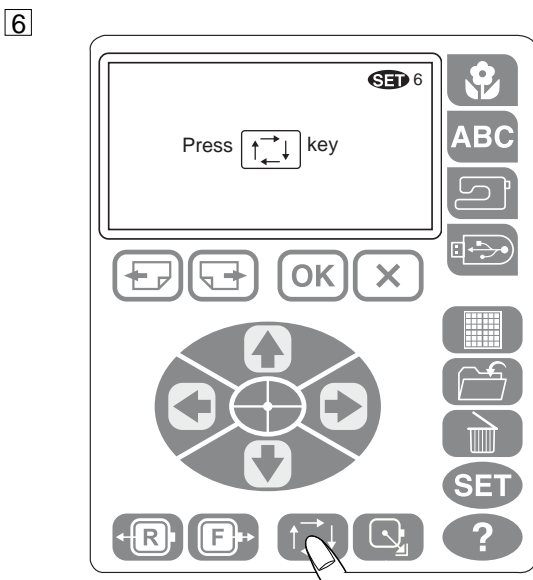

6 Press the trace key.

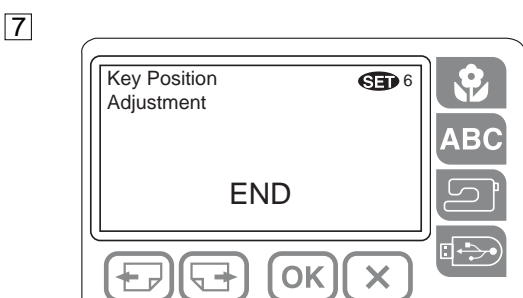

7 Press the OK key to confirm the adjustments and exit the setting mode.

7. Language Selection

You can select one of the following 11 languages by pressing the corresponding key.

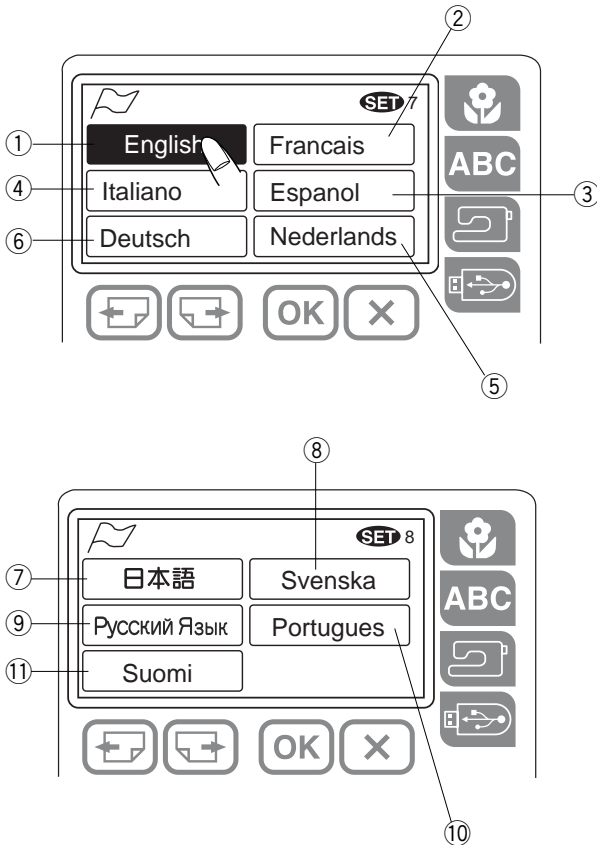

- ① English
- ② French
- ③ Spanish
- ④ Italian
- ⑤ Dutch
- ⑥ German
- ⑦ Japanese
- ⑧ Swedish
- ⑨ Russian
- ⑩ Portuguese
- ⑪ Finnish

Press the OK key to confirm your selection.

8. Default setting

When you press the YES key, all settings except language setting will return to default (the same settings as when you purchased the machine).



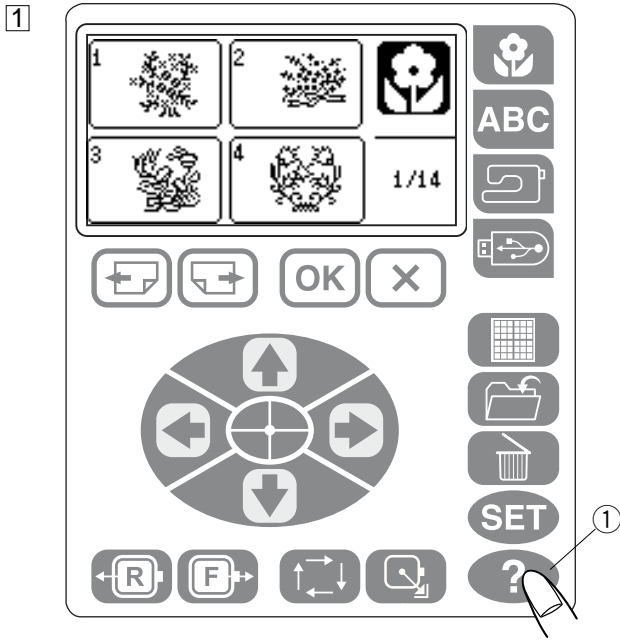

HELP key

Press this key to view the help topics for basic operations.

- 1 Press the help key.
 - ① Help key

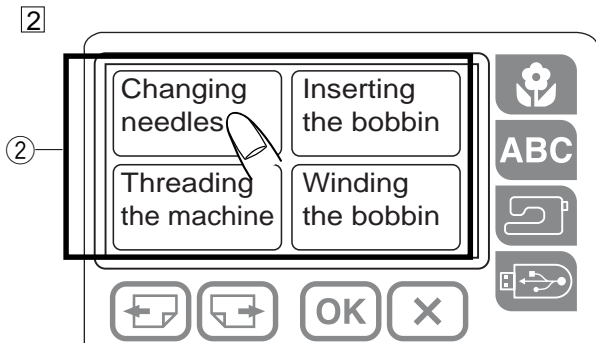

- 2 Press the help topic you want to see.
 - ② Help topics

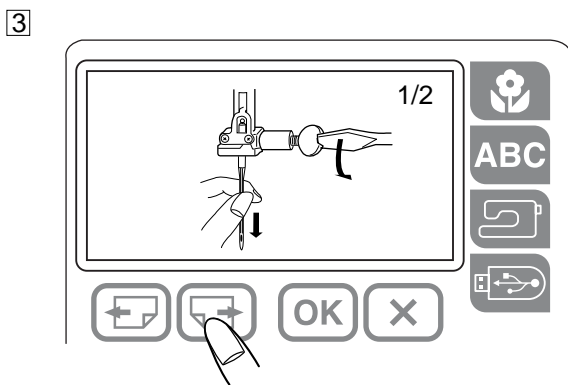

- 3 Press the page key to turn the page.
 - ③ Page key

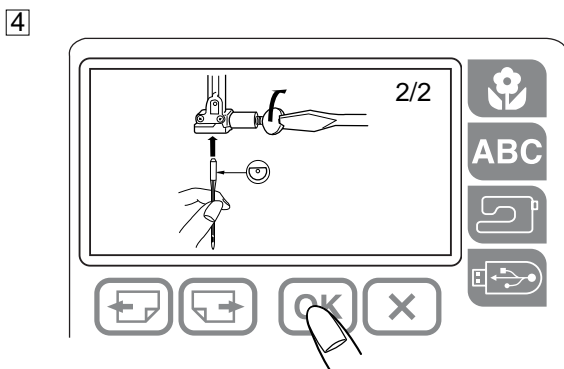

- 4 Press the exit key to return to the previous window.
 - ④ Exit key

Setting the fabric in the embroidery hoop

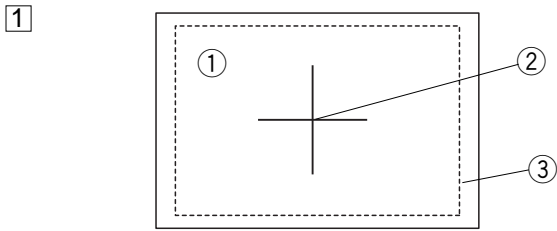

- 1 Attach a stabilizer to the wrong side of the fabric. Mark the centerlines on the right side of the fabric with tailor's chalk.

- ① Fabric
- ② Centerlines
- ③ Stabilizer

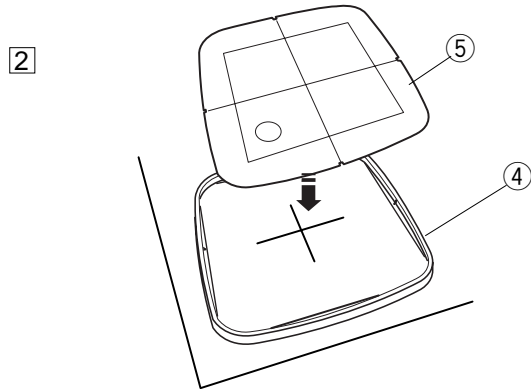

- 2 Place the inner hoop with the template on the fabric, matching the centerlines.

- ④ Inner hoop
- ⑤ Template

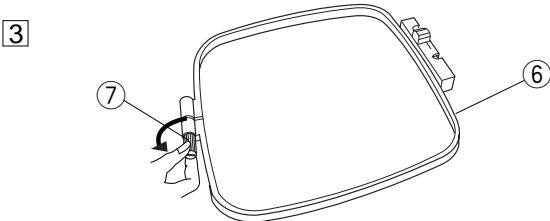

- 3 Loosen the hoop tightening screw of the outer hoop.

- ⑥ Outer hoop
- ⑦ Hoop tightening screw

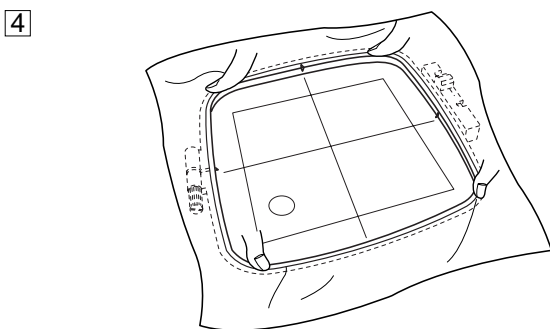

- 4 Lay the fabric and the inner hoop on the outer hoop. Push the inner hoop into the outer hoop.

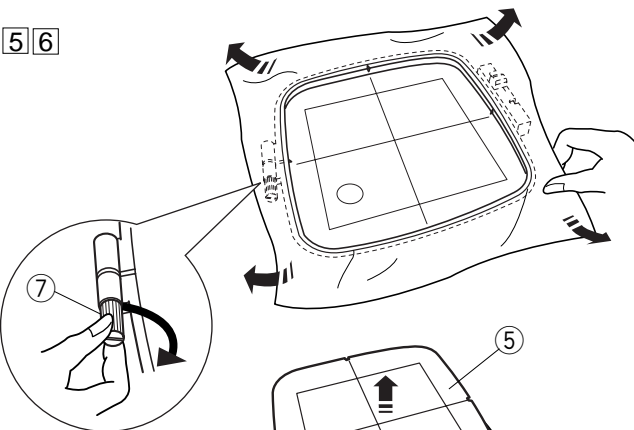

- 5 Tighten the hoop tightening screw. Pull fabric corners to remove wrinkles.

- 6 Tighten the hoop tightening screw securely.

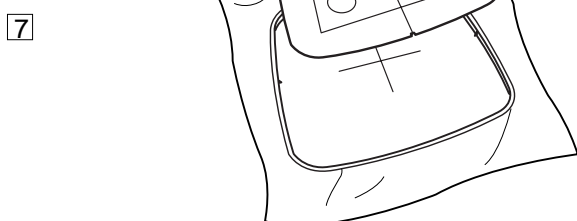

- 7 Remove the template.

Attaching the embroidery hoop to the machine

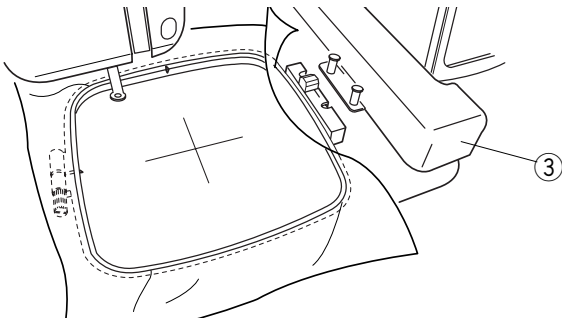

1 2

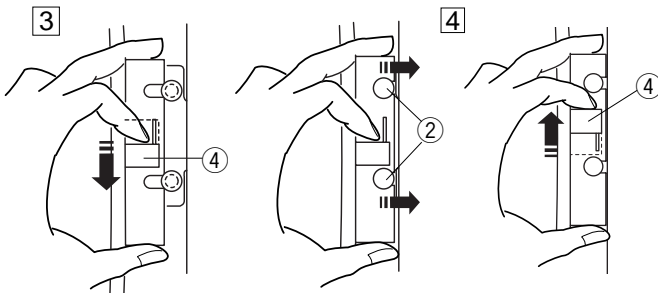
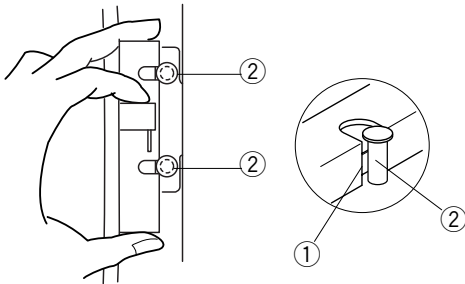

5 6

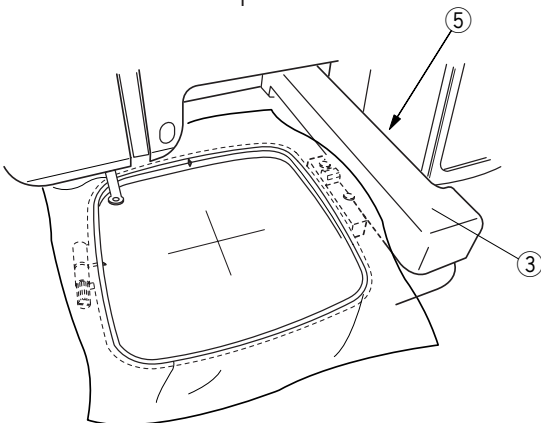
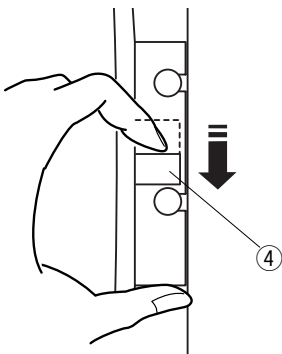

To attach

- 1 Raise the presser foot.
- 2 Place the prepared hoop on the machine. Position the hoop by aligning the notches of the hoop with the carriage pins.

- 1 Notch
- 2 Carriage pin
- 3 Carriage

- 3 Shift the lever in the direction of the arrow. Attach the hoop by pushing it against the carriage pins.

- 4 Lever

- 4 Release the lever to lock the hoop in place.

To remove

- 5 Raise the presser foot.

- 6 Shift the lever in the direction of the arrow and remove the hoop.

- 4 Lever

⚠ CAUTION:

- Be careful not to place the excess of fabric between the carriage and machine body (5).
- Never try to move the carriage by hand or touch the carriage while it is moving.

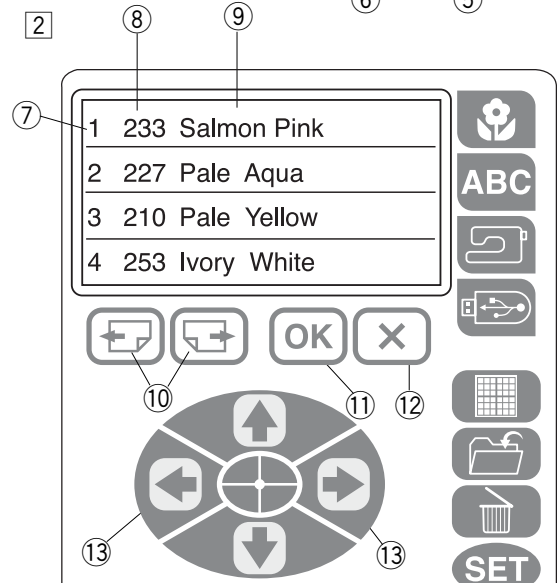
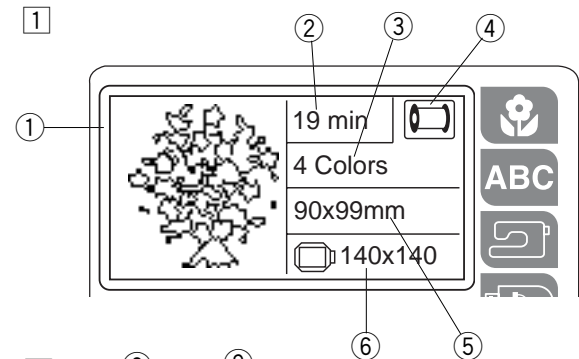
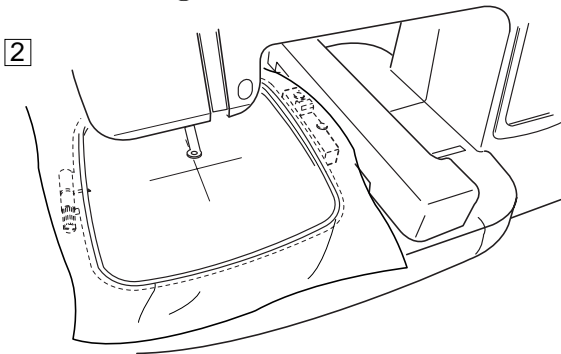
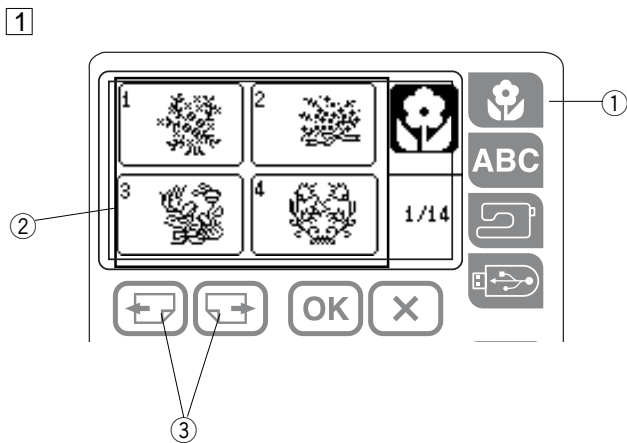

Selecting built-in designs

- 1 Your Memory Craft provides you with 14 pages of 55 ready-to-sew built-in designs. Press the pattern selection key to select the pattern you wish to sew. To view the next page, press the next page key.

- 1 Built-in design key
- 2 Pattern selection key
- 3 Page keys

To select the embroidery design, press the desired pattern selection key.

- 2 Pattern selection keys

- 2 The carriage goes to the starting position and the ready to sew screen will be shown.

Ready to sew screen

- 1 The LCD screen shows the following information.

- 1 Image of the selected design
- 2 Sewing time in minutes
- 3 Number of colors
- 4 Spool icon key
- 5 Design size
- 6 Hoop

Press the spool icon key to display a list of thread colors employed in the selected design.

Color list screen

- 2 Press the OK key or exit key to return to the original window.

If the design contains more than 4 colors simply press the next page key display the rest.

- 7 Sewing order of the thread color
- 8 Color code of the thread
- 9 Name of the color
- 10 Page keys
- 11 OK key
- 12 Exit key
- 13 Jog key

Starting to sew embroidery

1

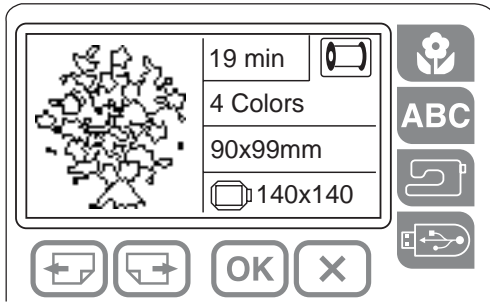

- 1 Press the pattern selection key to select the desired pattern.

2

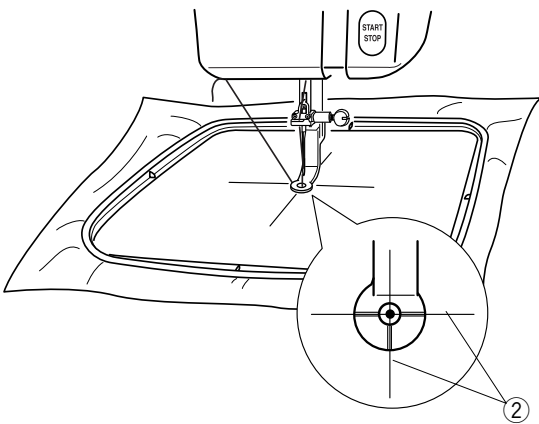

- 2 Adjust the hoop position with the jog keys ① so that the needle drop position comes right above the center of the centerlines ② on the fabric.

- ① Jog keys
- ② Centerlines

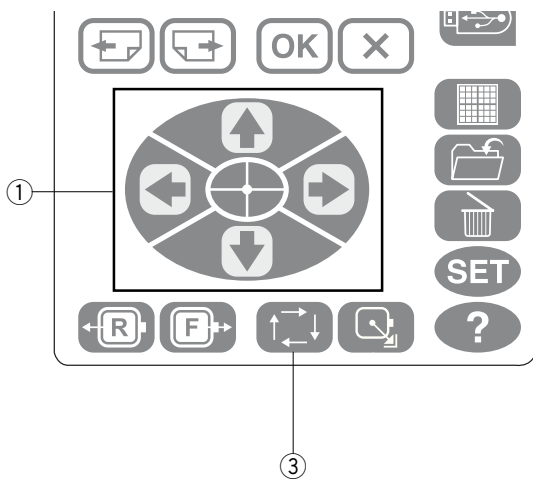

3

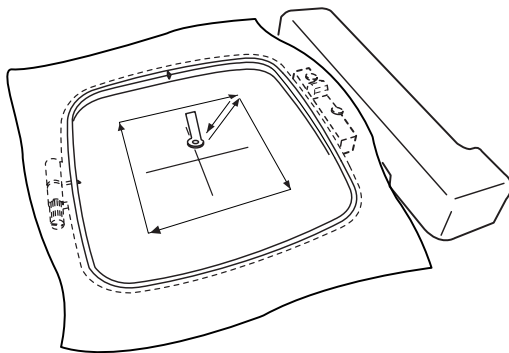

- 3 Press the tracing key to trace the outline of the selected design so that you can check the sewing position without stitching.

- ③ Tracing

4 5 6

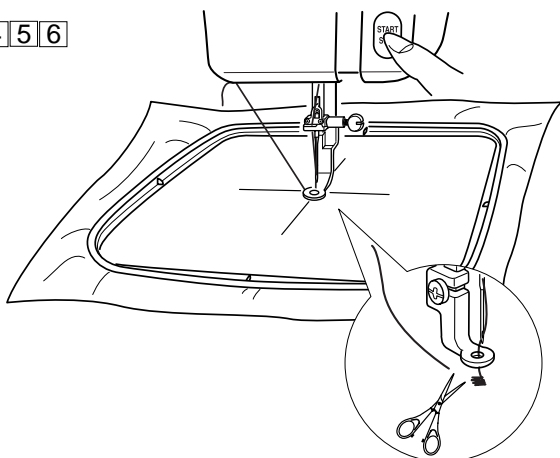

- 4 Lower the presser foot. Press the Start/Stop button and sew 5 to 6 stitches.
- 5 Press the start/stop button again to stop the machine. Raise the presser foot. Trim the thread.
- 6 Lower the presser foot and press the start/stop button. The machine will sew the first color section and stop automatically when it has finished.
- 7 Change the thread and sew the next section.

7

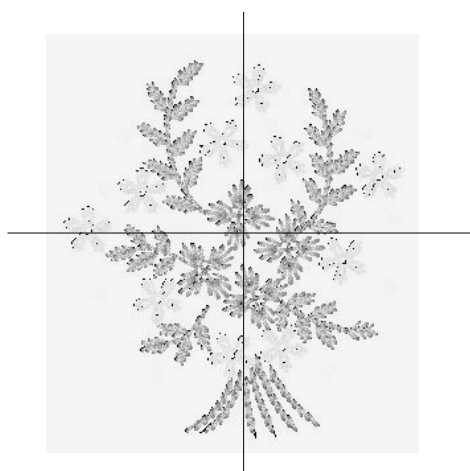

When the upper thread has broken or run out while sewing

- 1 Raise the the presser foot and rethread the needle thread.

* If the carriage position makes threading difficult, you can move the hoop for easier threading by pressing the home position key ①. After rethreading the needle thread, press the home position key ① again to return the carriage to the previous position.

① Home position key

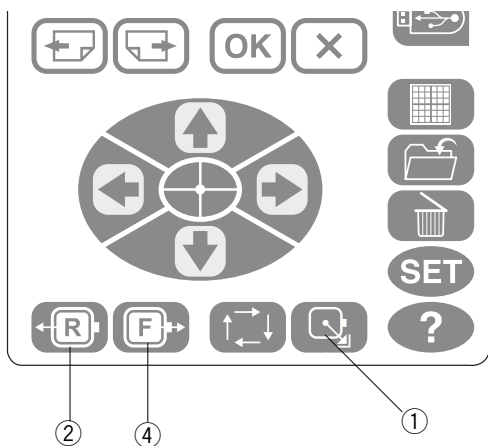

- 2 Press the stitch back key ② or stitch forward key ④ to move the embroidery hoop to where the thread has broken or run out ③. Press the stitch back key once ② to move the hoop back by 10 stitches.

② Stitch back key

③ Broken point

④ Stitch forward key

- 3 Lower the presser foot, and press the start/stop button and sew 5 to 6 stitches. Stop the machine and trim the thread.

- 4 Press the start/stop button and start the machine again.

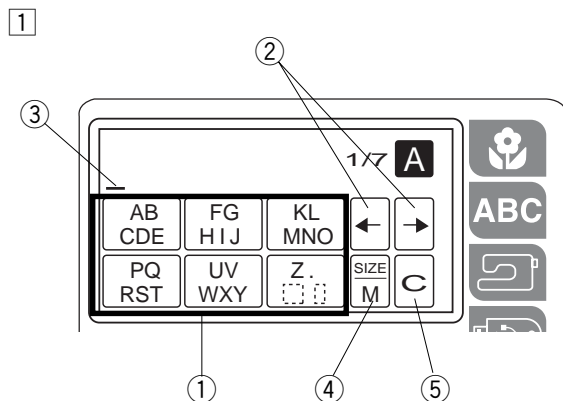
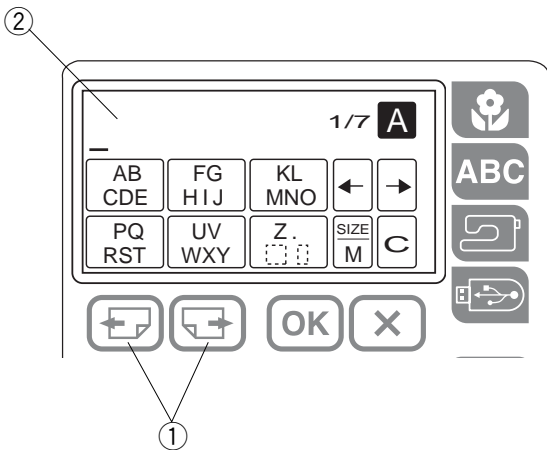
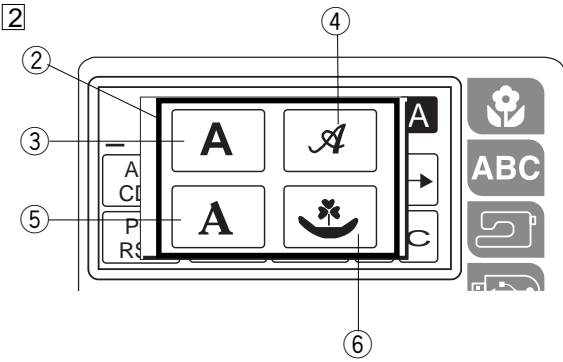
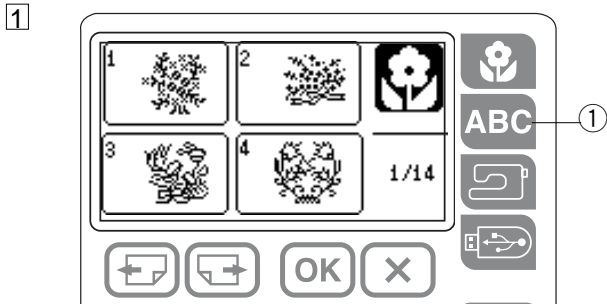

Lettering embroidery

Selecting fonts

You can select one of 3 styles of font and border patterns.

Press the lettering key ①. The font selection window will open ②.

- ① Lettering key
- ② Font selection window

Press one of the following keys to select the desired font or border pattern.

- ③ Gothic font
- ④ Script font
- ⑤ Cheltenham font
- ⑥ Border pattern

Entering characters

Select the desired font, and the window for upper case letters will open.

Press the next page key to display lower case letters, numbers and European accented letters.

The size of characters can be changed by pressing the letter size key ④.

To enter the character, press the letter or number key until the desired character appears.

- ① Uppercase letter keys
- ② Cursor keys
- ③ Cursor
- ④ Letter size key
- ⑤ Clear key

To enter lettering (For example: “Green”)

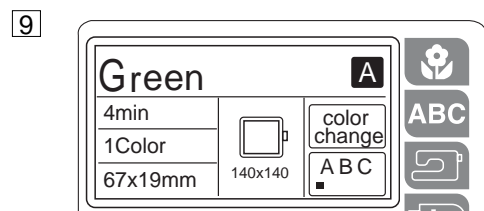
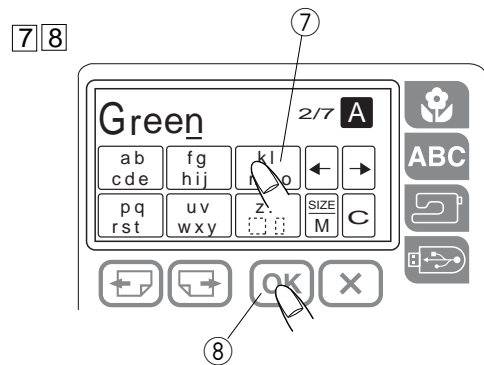
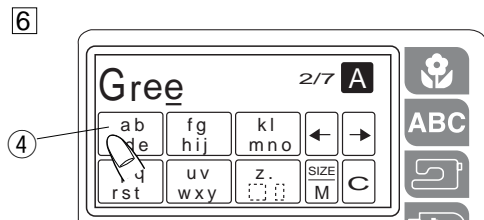
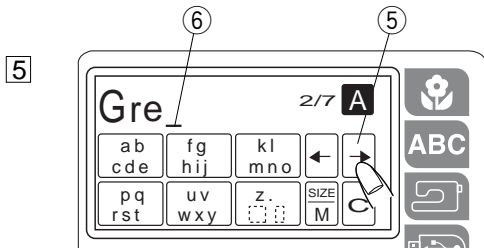
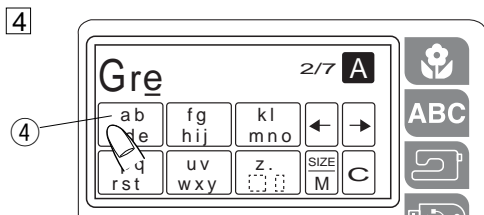
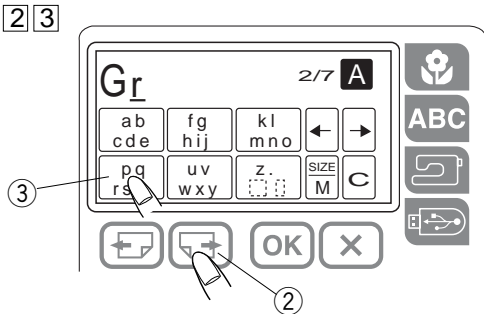
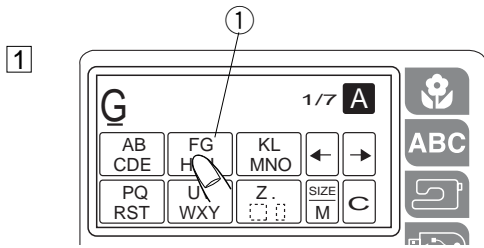

- 1 Press the ① key twice to select “G”.
- 2 Press the page key ② to select lower case letters.

- 3 Press the ③ key 3 times to select “r”.
- 4 Press the ④ key 5 times to select “e”.

- 5 Press the cursor key ⑤ to shift the cursor ⑥.

- 6 Press the ④ key 5 times to select “e”.

- 7 Press the ⑦ key 4 times to select “n”.

- 8 Press the OK key ⑧.
 - * Press the file save key to save the letter combination.
- 9 The display will change to the ready to sew screen.

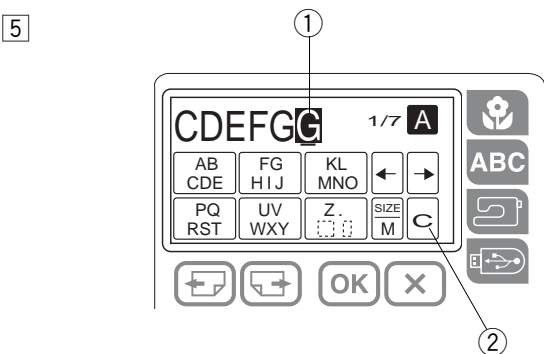
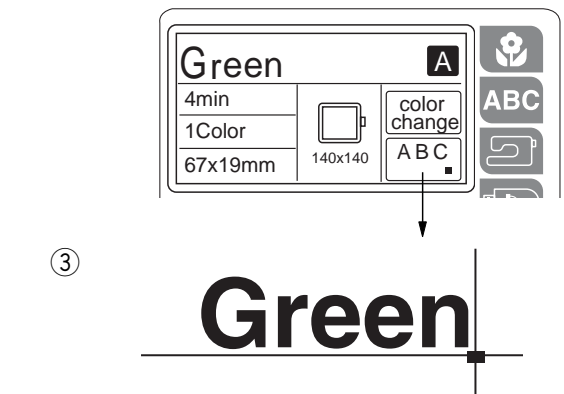
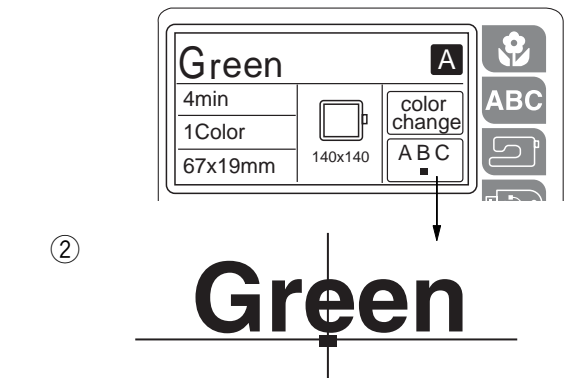
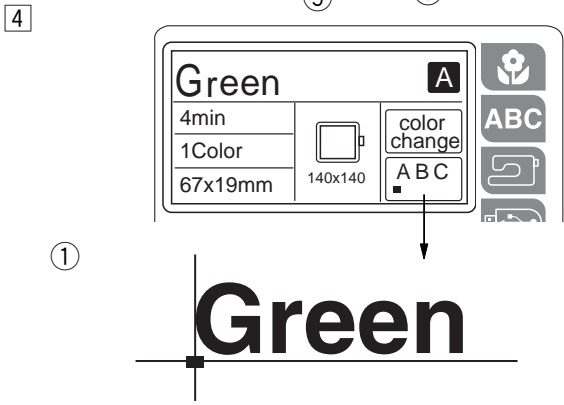
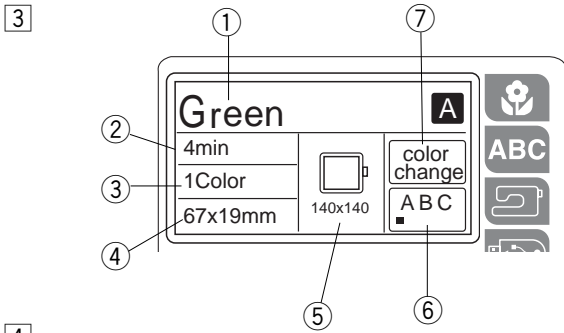

Ready to sew screen

- ① Lettering embroidery design
- ② Sewing time in minutes
- ③ Number of colors
- ④ Lettering size
- ⑤ Hoop size
- ⑥ Justification key
- ⑦ Color change key

Color change

You can sew a multi-colored lettering embroidery by changing the thread color of each letter if you press the color change key before sewing.

The machine will stop automatically when each letter has been sewn.

Change the thread to the next color and start sewing again.

Placement of lettering embroidery

You can select one of the 3 placements for lettering embroidery: left justify, center justify and right justify. Press the justification key to change the placement for lettering embroidery.

- ① Left justify
- ② Center justify
- ③ Right justify

Maximum number of characters

The maximum number of characters varies depending on the font and size. If you enter more characters than the maximum number, the last entered character will be highlighted.

Press the clear key to delete the highlighted character.

- ① Highlighted character
- ② Clear key

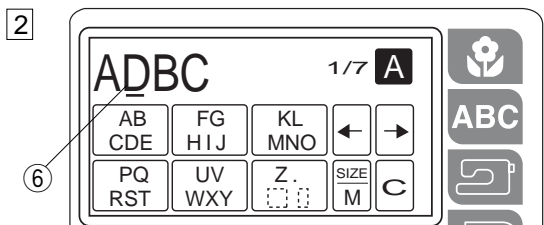
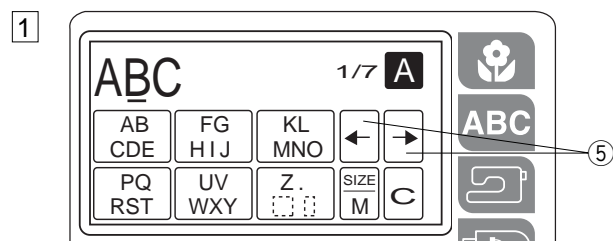
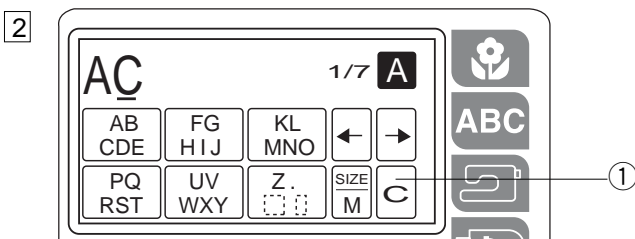
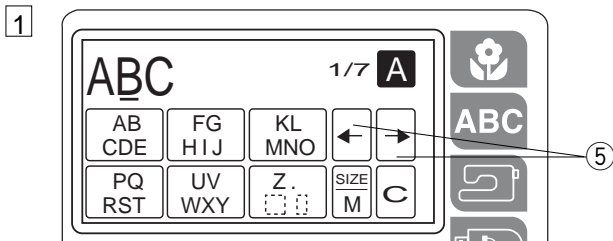
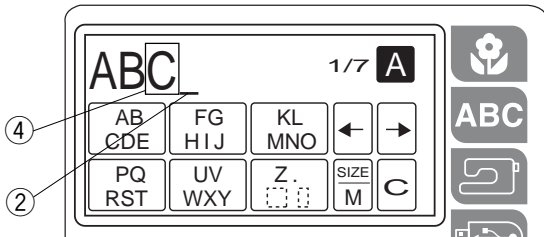
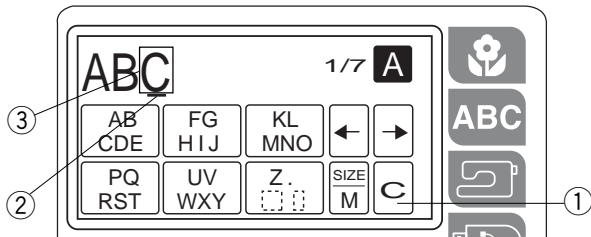
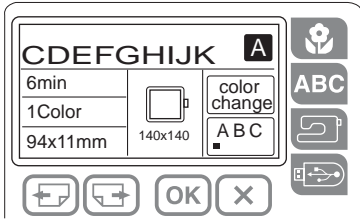
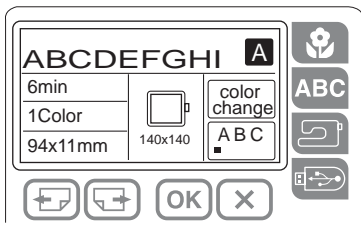

To view a long lettering

If the lettering is too long to display on the ready to sew screen, press the page key to show the hidden characters.

Example: Letters from A to K in S size.

The character shows letters from A to I. Press the next page key and letters C to K will be shown.

Deleting a letter

Pressing the clear key ① will delete the letter ③ above the cursor ② or the letter ④ in front of the cursor ②.

- ① Clear key
- ② Cursor key
- ③ Letter above the cursor key
- ④ Letter in front of the cursor key

① Press the cursor key to shift the cursor under the letter to delete.

- ⑤ Cursor keys

② Press the clear key to delete the letter.

- ① Clear key

Inserting a letter

You can insert the desired letter in front of the cursor.

① Press the cursor key ⑤ to shift the cursor under the letter "B".

② Press the key 4 times to insert the letter "D" ⑥.

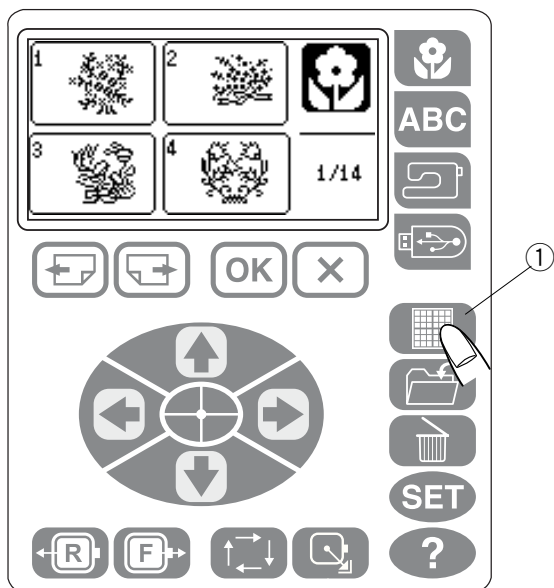

Editing mode

The editing function allows you to modify and combine embroidery patterns from the built-in memory or USB memory to create your own original designs.

Press the edit key ① and the editing window ② for the standard hoop will open.

- ① Edit key
- ② Editing window

The "+" mark indicates the center of the embroidery hoop.

- ③ Center mark

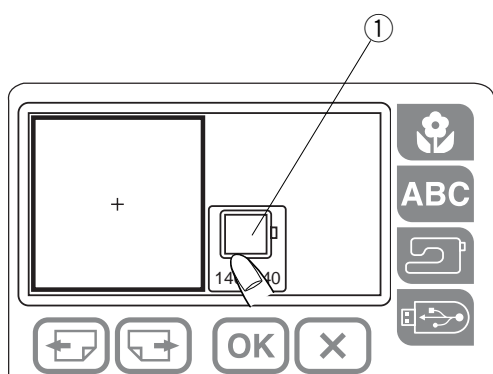
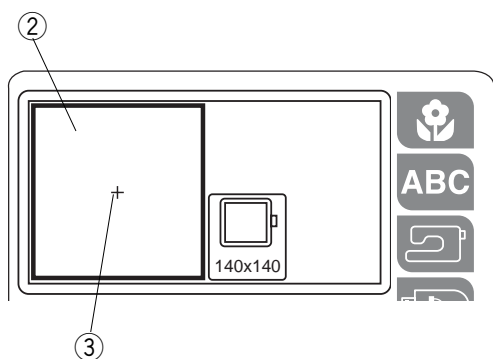

Selecting the hoop

When you use the optional hoop, press the hoop icon ①

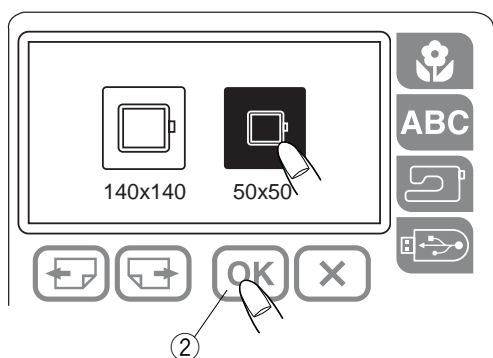

to open the hoop selection window.

Select the desired hoop and press the OK key ②.

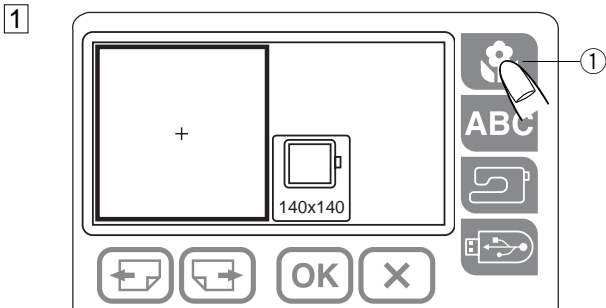

Selecting the pattern to edit
Example: Select the embroidery #51.

- 1 Press the built-in design key.
 - ① Built-in design key

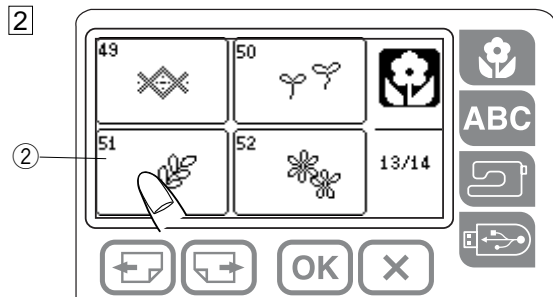

- 2 Select the pattern #51.
 - ② Pattern #51

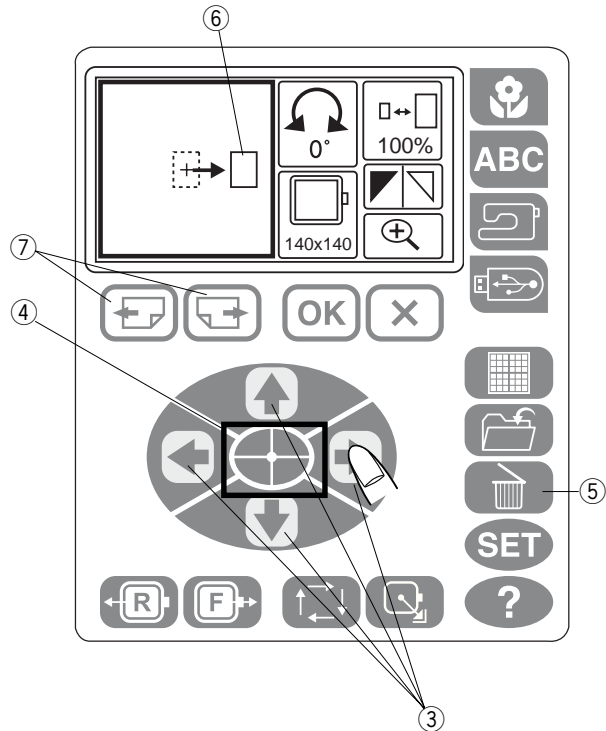

The editing window shows the relative size and placement of the pattern with a square block ⑥ instead of the pattern image.

- * To move the pattern, press the jog key.
 - ③ Jog key
- * Press the center key to place the embroidery in the center of the hoop.
 - ④ Center key
- * To delete the pattern, press the delete key.
 - ⑤ Delete key

If there are 2 or more patterns in the editing window, press the next or previous page key to select the pattern to edit.

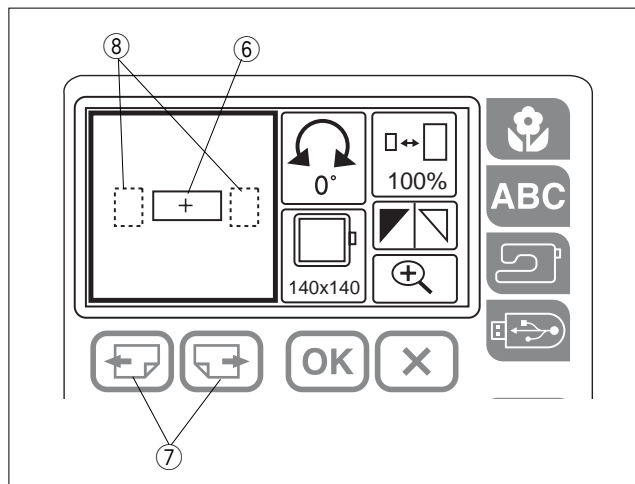

The selected pattern is displayed with a solid line. The patterns not selected are displayed with a dotted line.

- ⑥ Selected pattern
- ⑦ Page keys
- ⑧ Patterns not selected

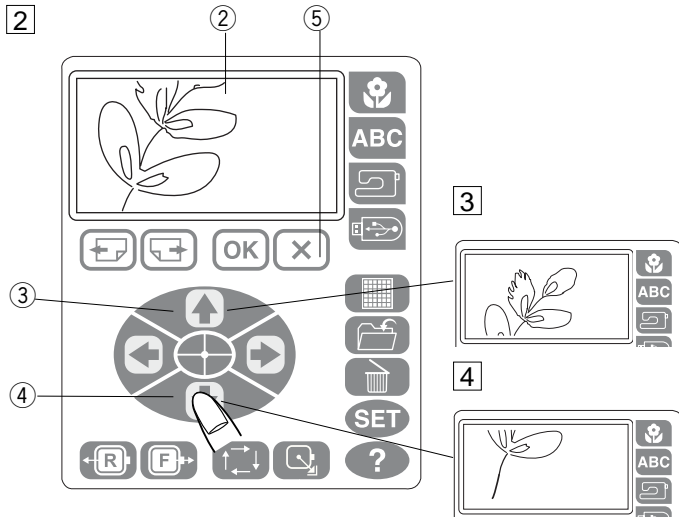
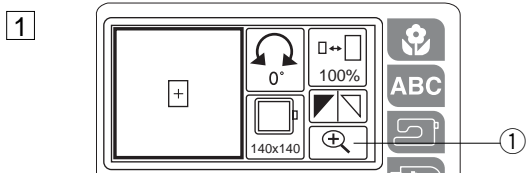

Magnifier key

- 1 Press the magnifier key to view the design image of the selected pattern.
 - 1 Magnifier key

- 2 The center of the magnified image will be displayed.
 - 2 Center part of the magnified image

- 3 Press the jog key (up) to scroll up the image.
 - 3 Jog key (up)

- 4 Press the jog key (down) to scroll down the image.
 - 4 Jog key (down)

- Press the exit key to return to the editing window.
- 5 Exit key

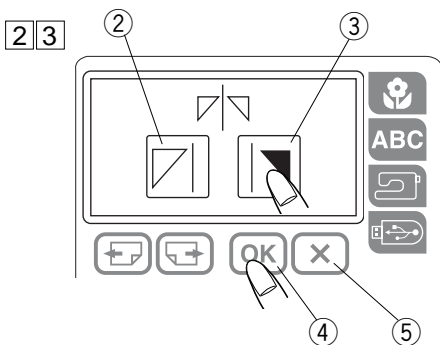
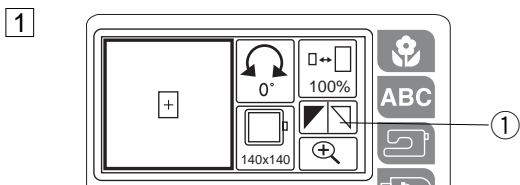

Flipping the pattern

You can flip the embroidery pattern horizontally.

- 1 Press the flip key. The flip window will open.
 - 1 Flip key

- 2 Press the flip to the right key 3.
 - 2 Flip to the left key
 - 3 Flip to the right key
 - 4 OK key
 - 5 Exit key

- 3 Press the OK key 4 to flip the selected pattern. Press the exit key 5 to exit the flip window without any change.

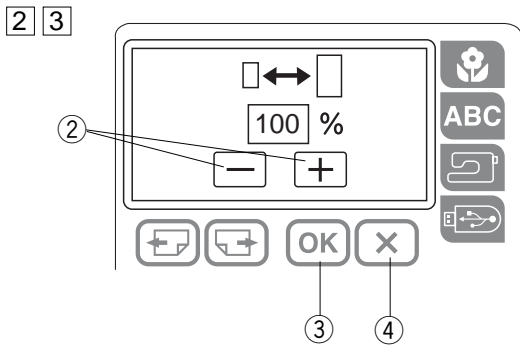
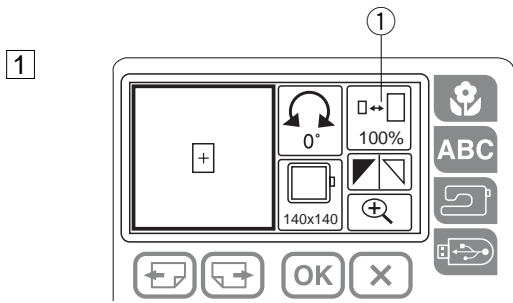

Resizing the pattern

You can change the size of the embroidery pattern from 90% to 120% of the original pattern size. The size will change 10% each time you press – or + key.

- 1 Press resize key ①.
 - ① Resize key
- 2 The resize window will open. Press - or + key ②.
- 3 Press the OK key ③ to resize the selected pattern. Press the exit key ④ to exit the resizing window without any change.

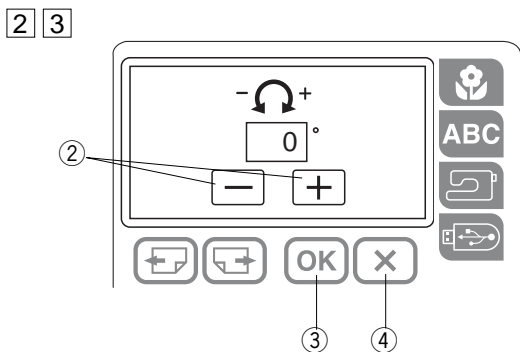
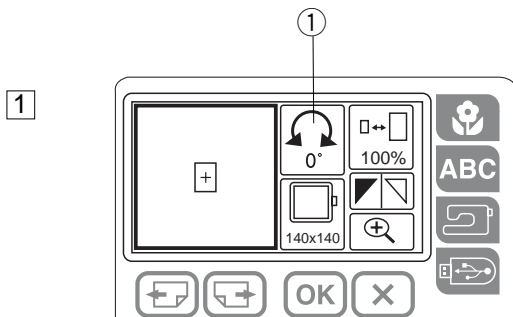

Rotating the pattern

You can rotate the selected embroidery pattern either clockwise or counterclockwise.

- 1 Press the rotate key ①.
 - ① Rotate key
- 2 The the rotate window will open. Press – or + key ② to rotate the selected embroidery pattern. The pattern will rotate 45 degrees clockwise or counterclockwise when pressing one of the keys.
- 3 Press the OK key ③ to rotate the selected pattern. Press the exit key ④ to exit the rotate window without any change.

1

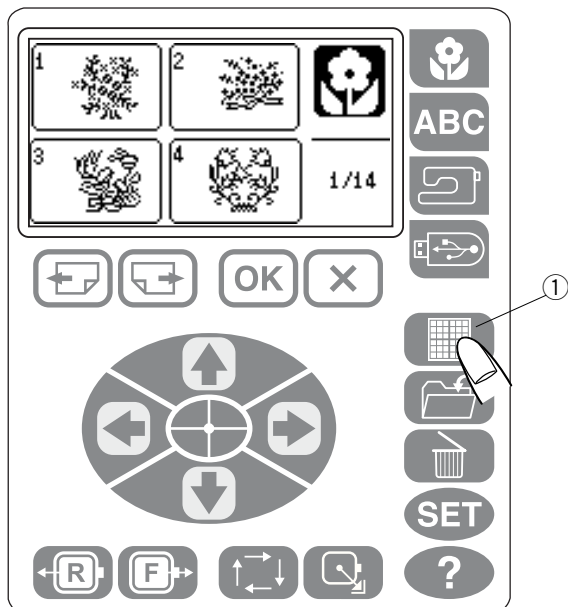

Combining patterns
(For example: pattern #51 and lettering)

1 Press the edit key ①.

2

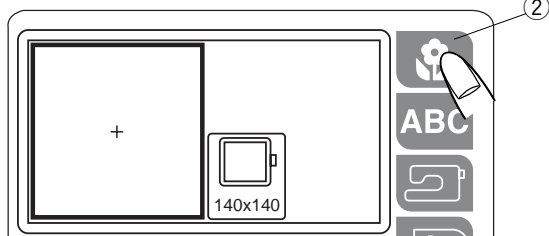

2 Press the built-in design key ②.

3

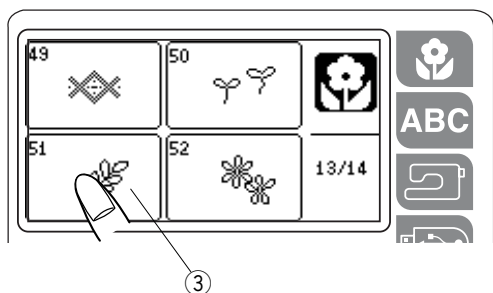

3 Select the pattern #51 ③.

4

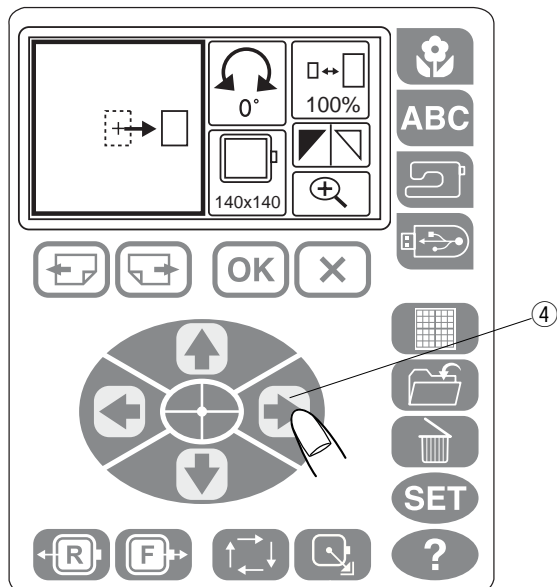

4 Press the jog key ④ to move the embroidery pattern to the right.

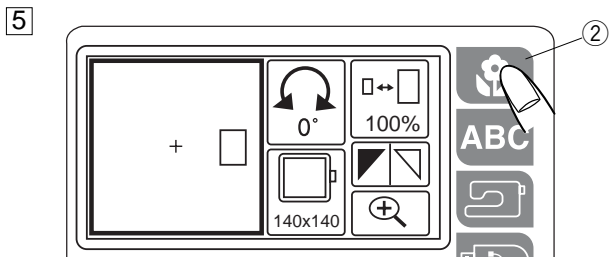

5 Press the built-in design key ②.

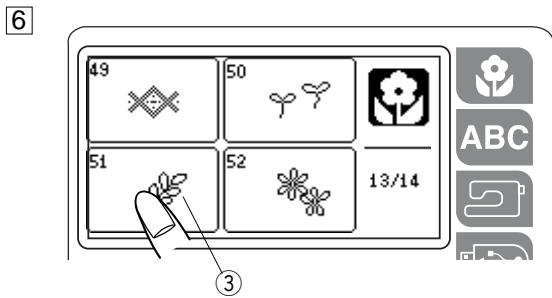

6 Select the pattern #51 ③.

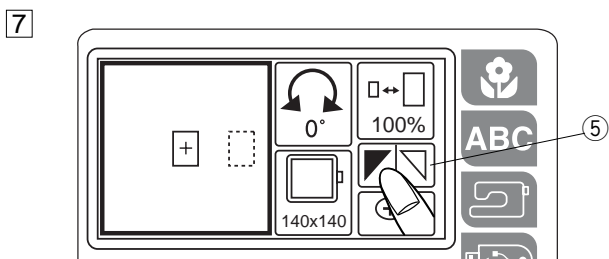

7 Press the flip key ⑤.

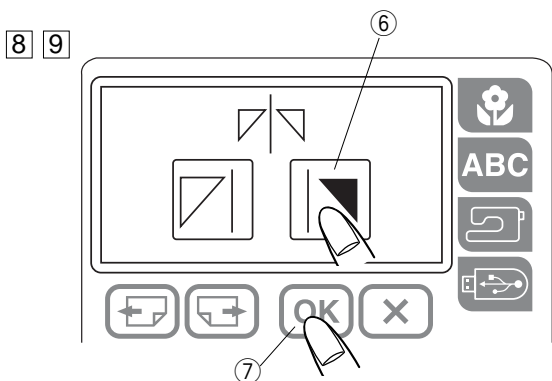

8 Press the flip to the right key ⑥ to flip the embroidery pattern.

9 Press the OK key ⑦.

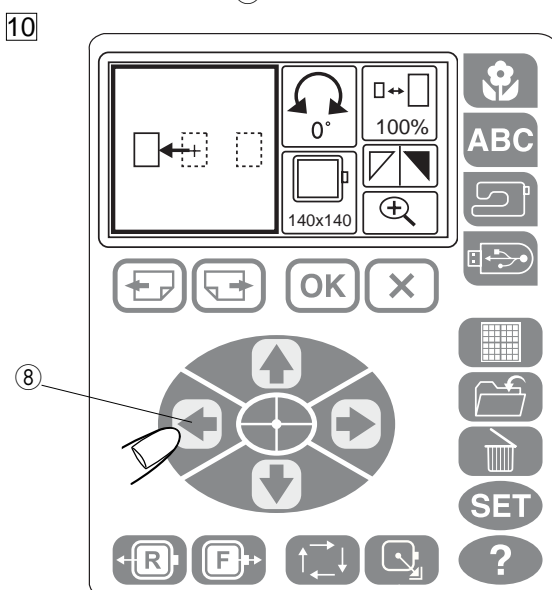

10 Press the jog keys ⑧ to move the embroidery pattern to the left.

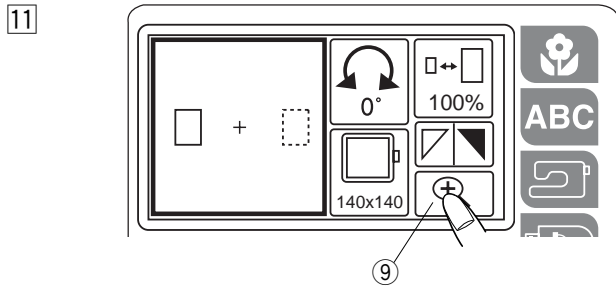

11 Press the magnifier key ⑨ and view the placement of the embroidery patterns.

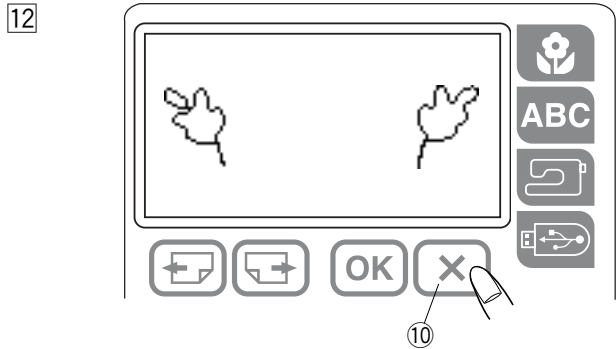

12 Press the exit key ⑩ to return to the editing window.
⑩ Exit key

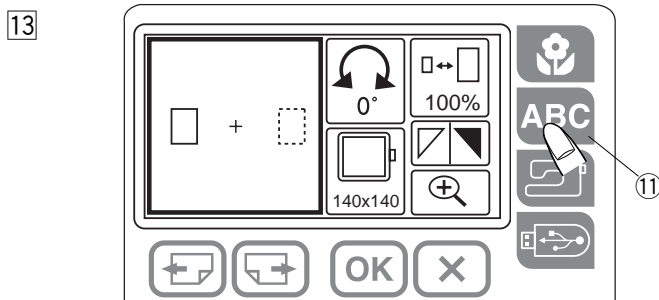

13 Press the lettering key ⑪.
⑪ Lettering key

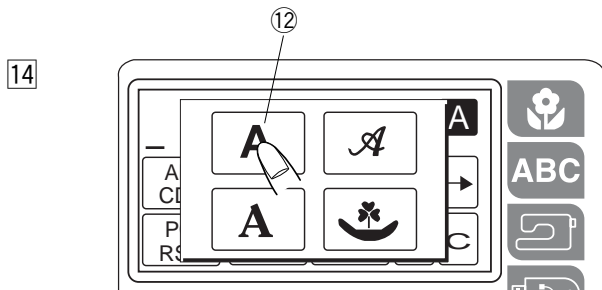

14 Press the Gothic font key ⑫.

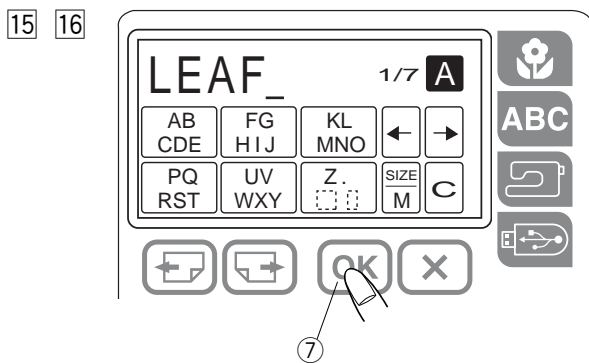

15 Enter the letters (For example: LEAF).
16 Press the OK key ⑦.

17

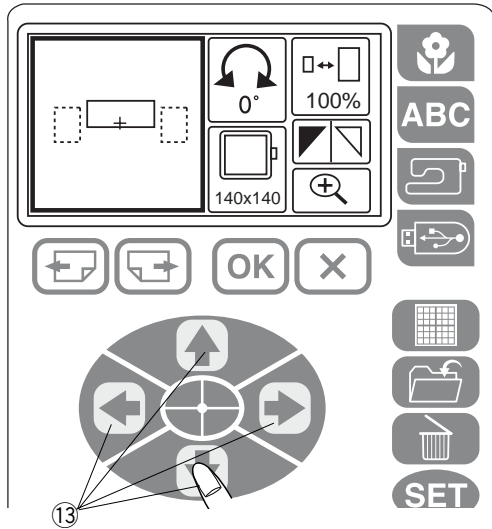

- 17 Press the jog keys 13 to move the letters down.
- 13 Jog keys

18

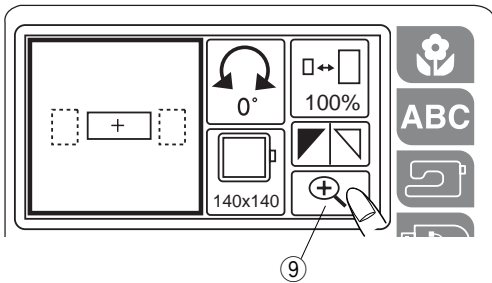

- 18 Confirm the layout of the embroidery by pressing the magnifier key 9.
- 9 Magnifier key

19



- 19 Press the exit key 10 to return to the editing window.
- 10 Exit key.

20

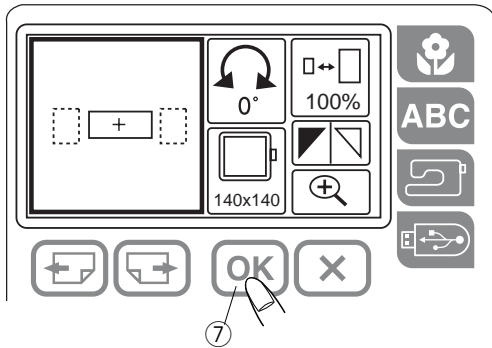

- 20 Press the OK key 7.
- 7 OK key

21

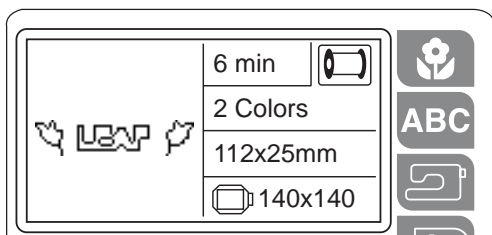

- 21 Start sewing.

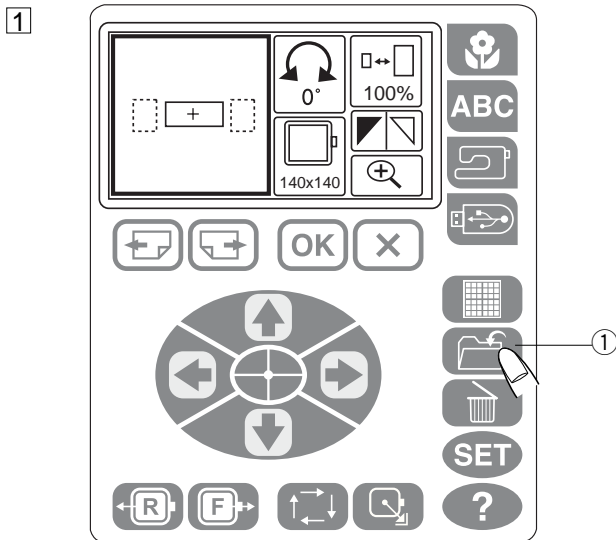

Saving the file

An original embroidery design created in the editing mode can be saved as a file in the built-in memory or USB memory.

Saving in internal memory

1 Press the file-save key ①.

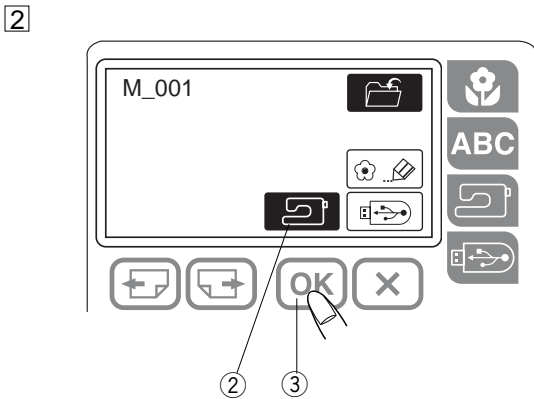

2 The save file window will open.

Press the internal memory key ②.

Press the OK key to save the file ③.

The file name will automatically be assigned starting from M_001...in order.

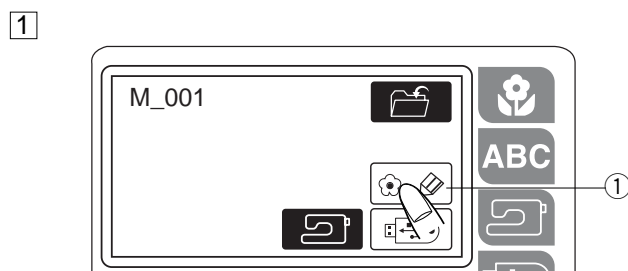

Name of file

You can assign a desired name to your own file. (8 characters can be entered for the file name.)

For example, assign "U_2" for the file name.

1 Press the name key ①.

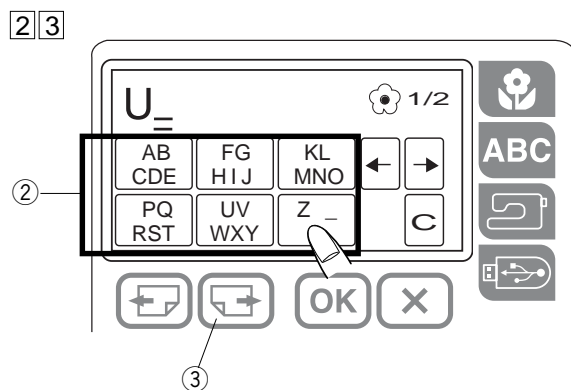

2 The window for entering the name will open. Press the letter keys ② and enter "U_".

3 Press the next page key ③.

4 5

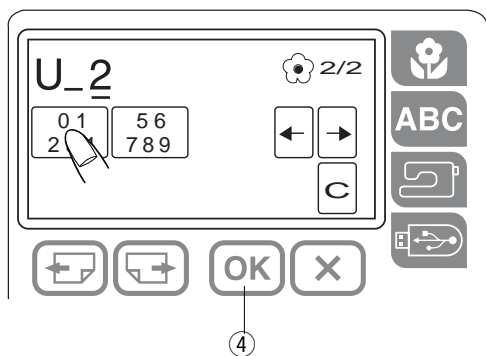

4 Enter "2".

5 Press the OK key ④.

6

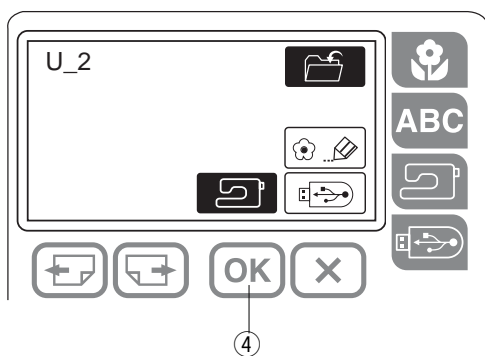

6 Press the OK key ④ to save the file under the new name.

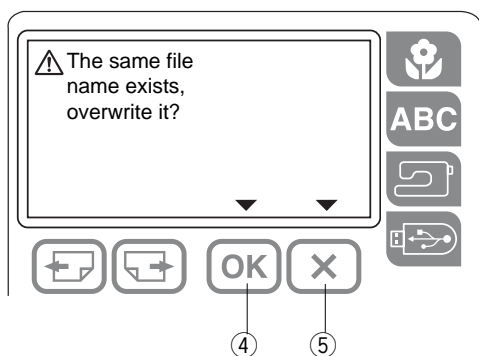

When you attempt to save a file when the name already exists, the confirmation message will appear. Press OK key ④ to overwrite the existing file. Press the exit key ⑤ if you do not wish to overwrite it.

4 5

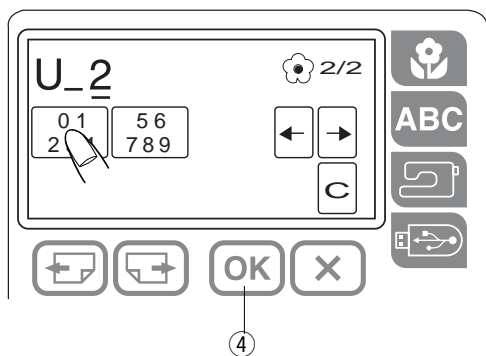

4 Enter "2".

5 Press the OK key ④.

6

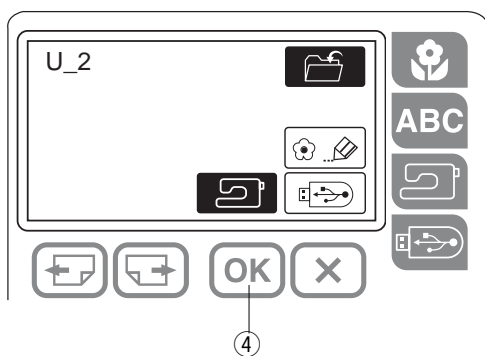

6 Press the OK key ④ to save the file under the new name.

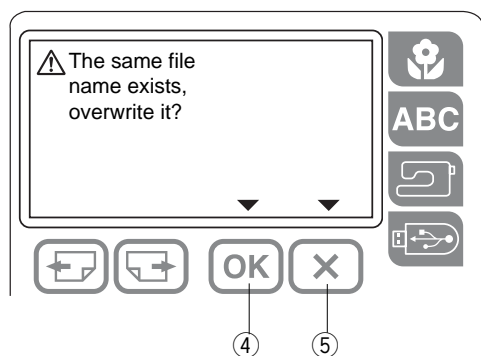

When you attempt to save a file when the name already exists, the confirmation message will appear. Press the OK key ④ to overwrite the existing file. Press the exit key ⑤ if you do not wish to overwrite it.

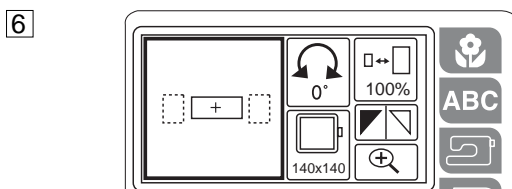
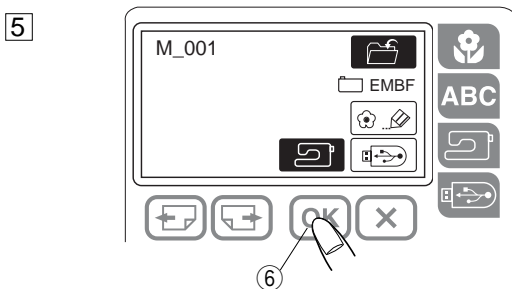
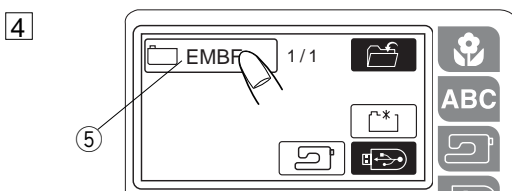
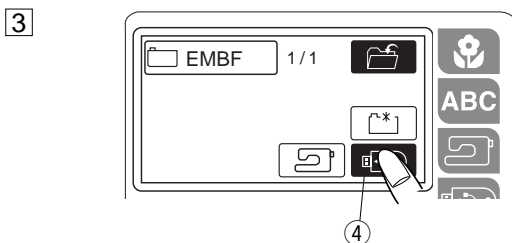
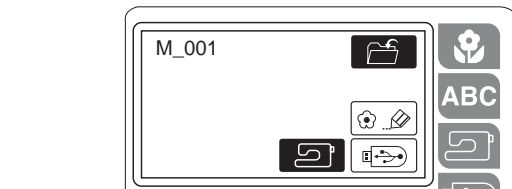
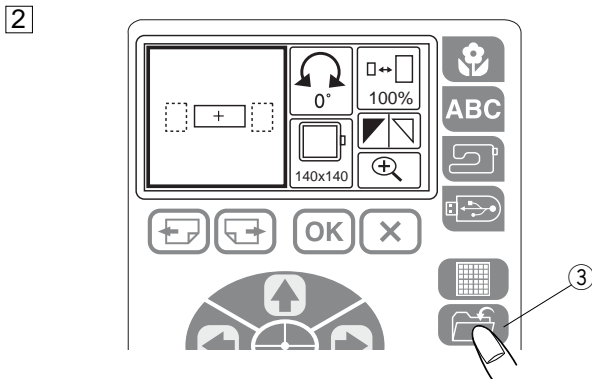
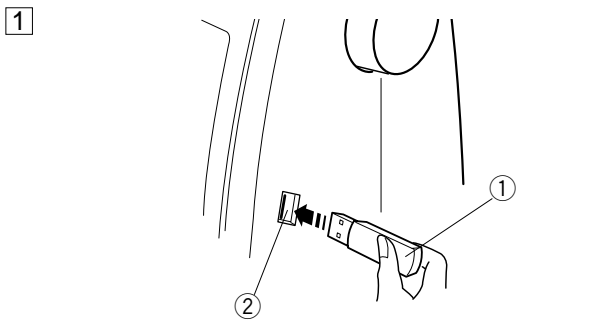

Saving in USB memory (Optional)

USB memory can be used to save the stitch data.

- 1 Insert the USB memory ① into the USB socket ②.
 - ① USB memory
 - ② USB socket

- 2 Press the file save key.
The file-save screen will open.
 - ③ File-save key

⚠ CAUTION:

Do not turn the power off, or remove the USB memory while a warning message has been displayed on the screen. Otherwise the saved data will be lost or the memory will be damaged.

- 3 Press the USB memory key.
The folder list will be displayed on the screen.
 - ④ USB memory key

NOTE:

The EMBF folder will automatically be created when inserting the USB memory for the first time.

- 4 Press the folder icon to open.
 - ⑤ Folder icon

- 5 Press the OK key to save the file. The file name will be automatically assigned from M_001.
 - ⑥ OK key

- 6 The screen returns to the previous display.

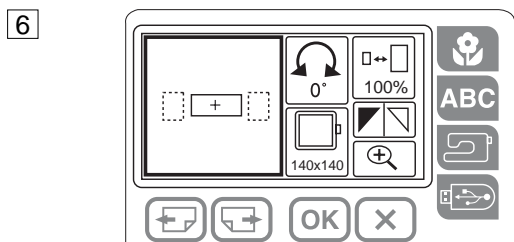
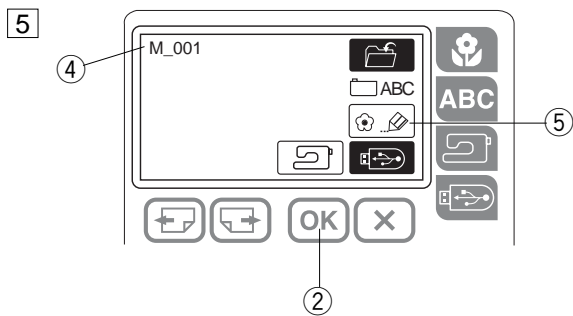
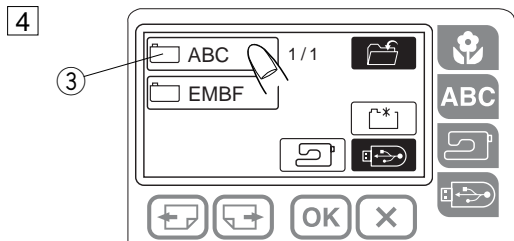
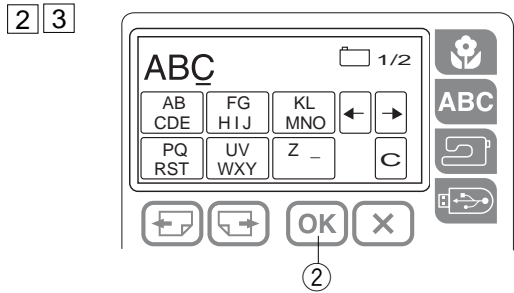
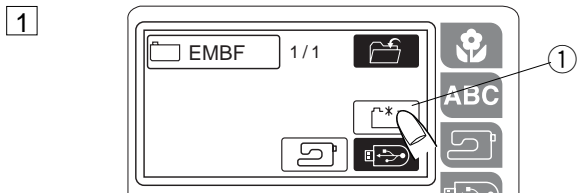

Creating a new folder

You can create your own folder and assign the desired name to it.

- 1 Press the folder key ①.
 - ① Folder key
- 2 Enter the folder name.
(Only 8 characters can be entered).
For example, enter “ABC” for the folder name.
- 3 Press the OK key ②.
 - ② OK key
- 4 Press the ABC folder to open.
 - ③ ABC folder
- 5 Press the OK key ② to save the file in a new folder.
 - ② OK key
- 6 The screen returns to the previous screen.

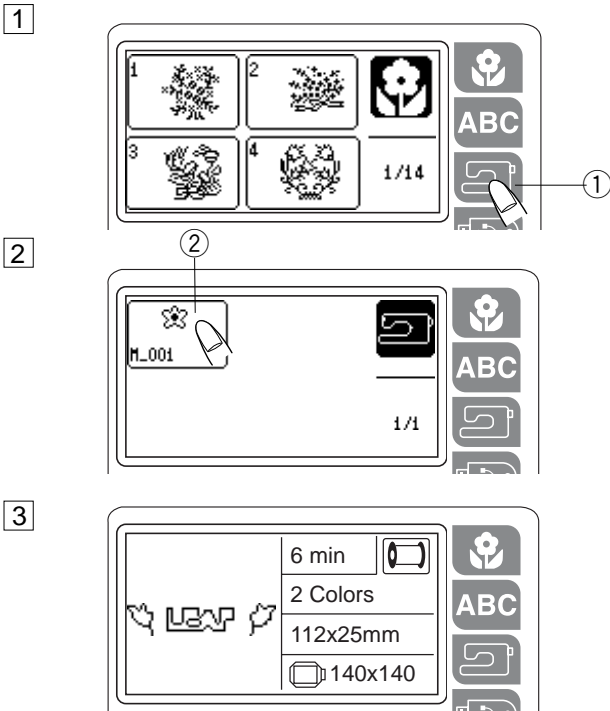

Opening a file from the internal memory

To open the saved files, press the internal memory key and the open file window will open.

- 1 Press the internal memory key ①.
- 2 File list will be displayed.
Press the icon key to open the file you wish to sew.
- 3 The screen will display the ready to sew window of the saved design. Lower the presser foot and start sewing.

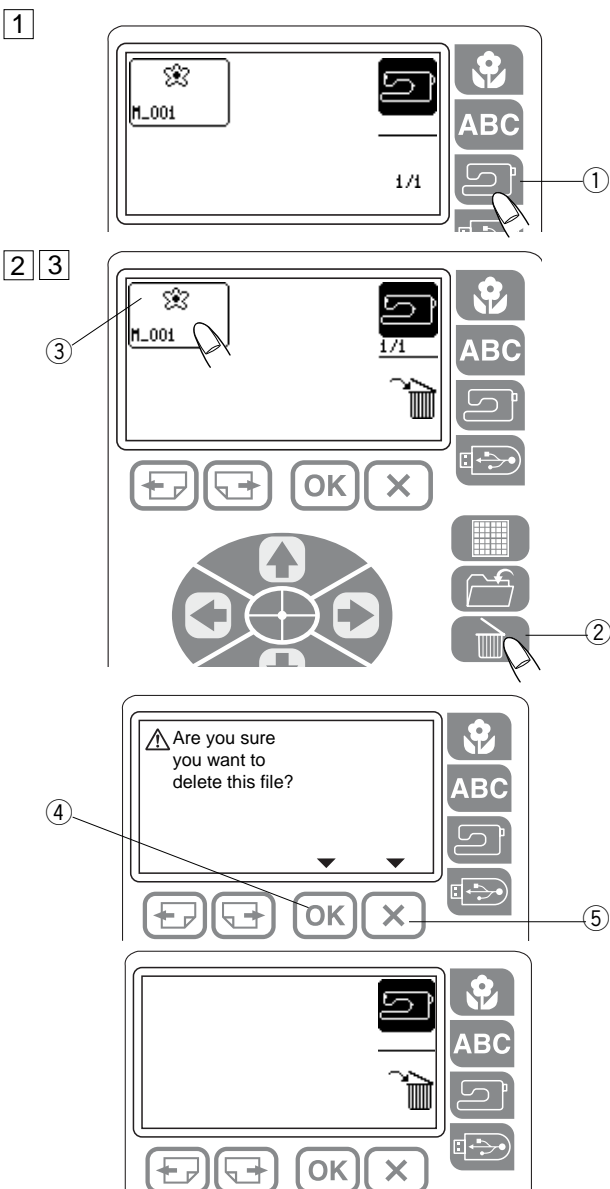

Deleting a file

You can delete the file no longer needed.

- 1 Press the internal memory key ①.
 - ① Internal memory key
- 2 File list will be displayed.
Press the delete key ②.
 - ② Delete key
- 3 Select the file ③ you wish to delete.
- 4 The confirmation window will appear. Press the OK key ④ to delete the selected file.
Press the exit key ⑤ instead of the OK key to return to the previous screen without deleting the file.
 - ④ OK key
 - ⑤ Exit key

Opening a file from USB memory (Optional)

1

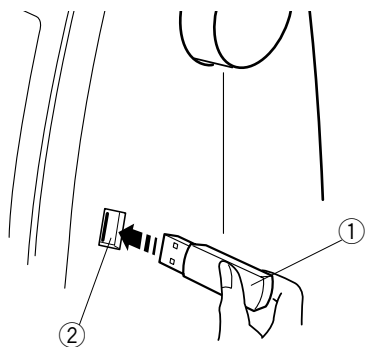

1 Insert the USB memory ① into the USB socket ②.

① USB memory

② USB socket

2

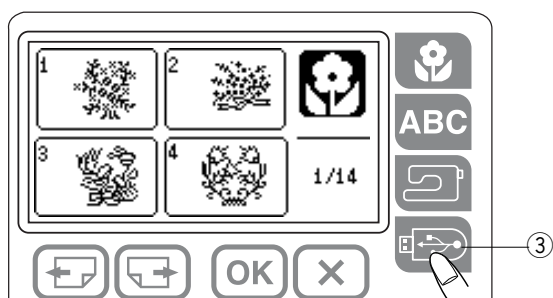

2 Press the USB memory key.

The file-open window will open.

③ USB memory key

3

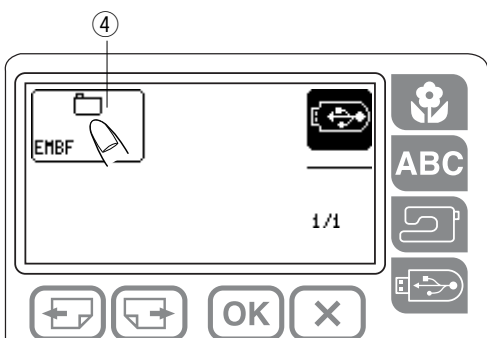

3 Press the desired folder ④ to open.

④ Folder icon

4

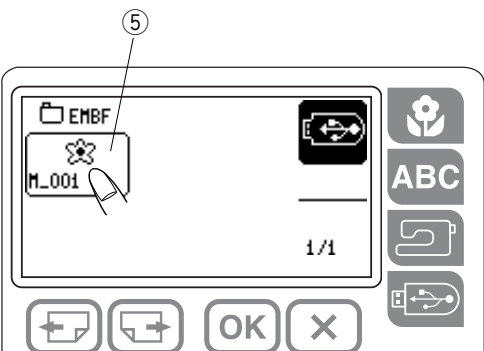

4 The file list will be displayed.

Press the icon key ⑤ to open the file.

⑤ Icon

5

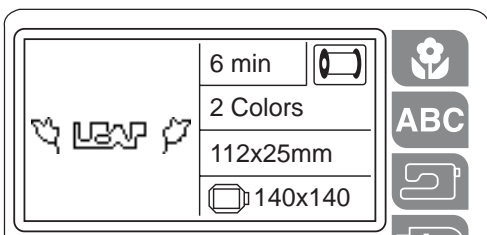

5 The ready to sew screen will be displayed.

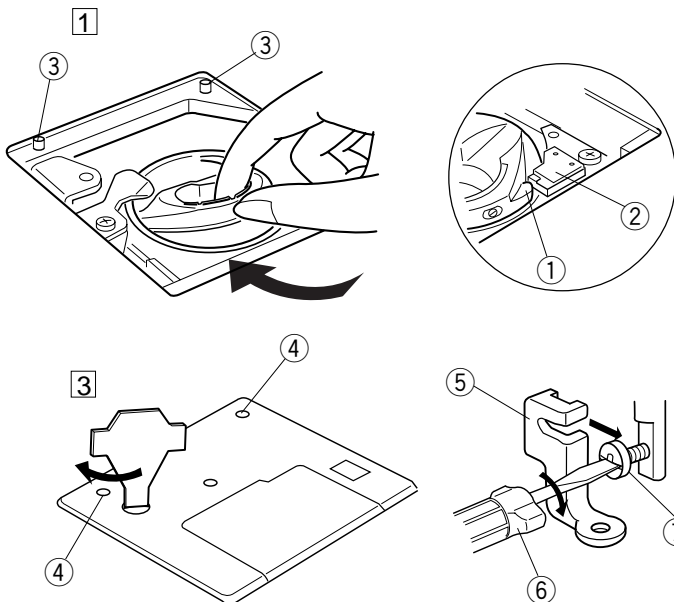
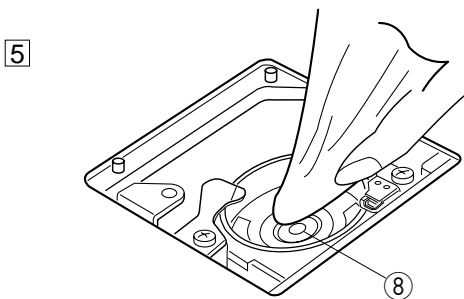
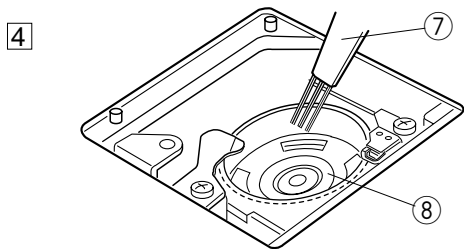
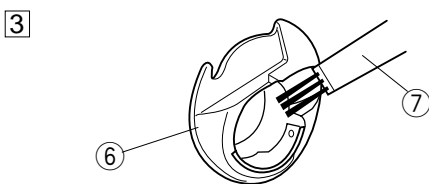
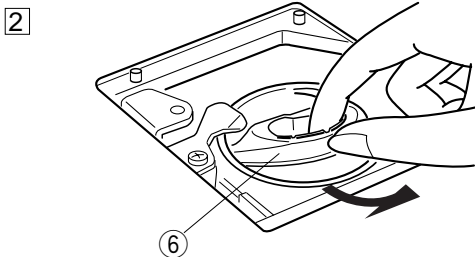
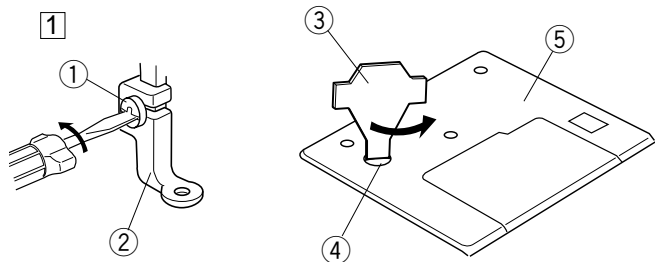

CARE AND MAINTENANCE

Cleaning the hook race



WARNING:

Turn the power switch off and unplug the machine before cleaning.

NOTE:

Do not dismantle the machine in any way other than what is explained in this section.

Clean the outside of the machine with a soft cloth and mild soap.

- 1 Remove the setscrews with the screwdriver supplied with the machine. Remove the needle plate and presser foot.

- ① Setscrew
- ② Presser foot
- ③ Screwdriver
- ④ Setscrew
- ⑤ Needle plate

- 2 Lift up the bobbin holder ⑥ and remove it.

- ⑥ Bobbin holder

- 3 Clean the bobbin holder with the lint brush ⑦.

- ⑦ Lint brush

- 4 Clean the hook race with the lint brush.

- ⑧ Hook race

- 5 Clean the hook race with a dry cloth.

(You may also use a vacuum cleaner.)

Assembling the hook race

- 1 Insert the bobbin holder so that the knob fits next to the stopper in the hook race.

- ① Knob
- ② Stopper

- 2 Reattach the presser foot and needle plate.

Align the needle plate guide pins with the guide holes on the needle plate and tighten the screw.

- ③ Needle plate guide pins

NOTE:

After cleaning the machine, make sure the needle and presser foot are attached.

TROUBLESHOOTING

Problem:	Cause:	Reference:
The machine is noisy	1 Threads have been caught in the hook mechanism.	See page 45.
The needle thread breaks.	1 The needle thread is not threaded properly. 2 The needle thread tension is too tight. 3 The needle is bent or blunt. 4 The needle is inserted incorrectly. 5 The needle thread is not set in the thread holder when starting the machine.	See pages 9. See page 13. See page 12. See page 12. See page 11.
The bobbin thread breaks.	1 The bobbin thread is not threaded properly in the bobbin holder. 2 Lint has collected in the bobbin holder. 3 The bobbin is damaged and does not turn smoothly.	See page 8. See page 45. Replace the bobbin.
The needle breaks.	1 The needle is inserted incorrectly 2 The needle is bent or blunt. 3 The needle clamp screw is loose. 4 The needle thread tension is too tight.	See page 12 See page 12. See page 12. See page 13.
Visual Touch Screen is not clear.	1 The screen contrast of the visual touch screen is not adjusted correctly.	See page 15.
Skipped stitches.	1 The needle is inserted incorrectly. 2 The needle is bent or blunt. 3 The needle thread is not threaded properly. 4 The defective needle (rusted, burred needle eye) is used. 5 The embroidery hoop is not set properly. 6 The fabric is not tightly pulled on the embroidery hoop. 7 A stabilizer is not being used.	See page 12. See page 12. See pages 9 Replace the needle. See page 23. See page 22. See page 14.
The machine does not run.	1 A thread is caught in the hook race. 2 The control circuit is not working correctly. 3 The machine is not connected to the power supply.	See page 45. Turn the switch off and turn it on again. See page 4.
Abnormal noise occurs when the machine is switched on.	1 Something is caught between the carriage and the arm.	Remove the object.
Patterns are distorted.	1 The fabric is not pulled tightly on the embroidery hoop. 2 The embroider hoop is not fixed securely. 3 The carriage is bumping into something around the machine. 4 The fabric is caught or pulled for some reason when sewing embroidery. 5 The needle thread tension is too tight. 6 A stabilizer is not used.	See page 22. See page 23. See page 23. Stop the machine and free the fabric. See page 13. See page 14.

Problem:	Cause:	Reference:
Pattern selection keys do not work.	<ol style="list-style-type: none"> 1 Key position is not adjusted properly. 2 The control circuit is not working correctly. 3 The bobbin winder spindle is in the winding position. 	<p>See page 18. Turn the switch off and turn it on again. See page 7.</p>
USB memory does not work	<ol style="list-style-type: none"> 1 The USB memory is not inserted correctly. 2 The USB memory is damaged. 	<p>See pages 41 See page 18</p>

DESIGN CHARTS

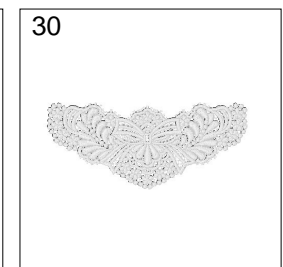
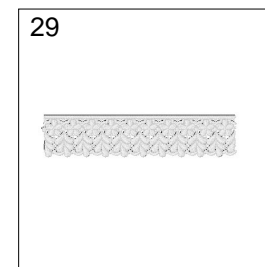
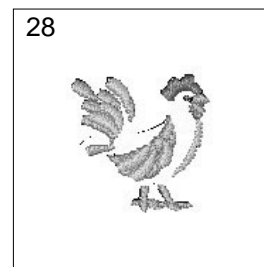
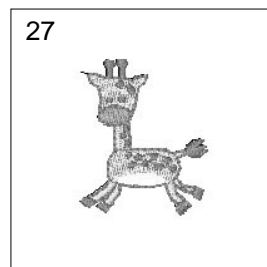
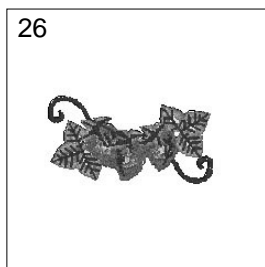
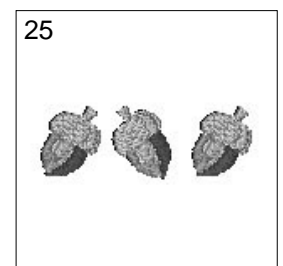
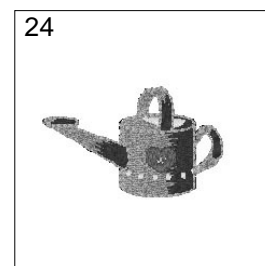
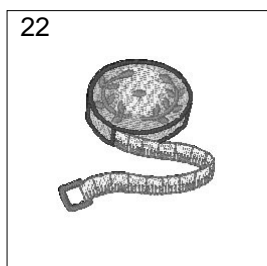
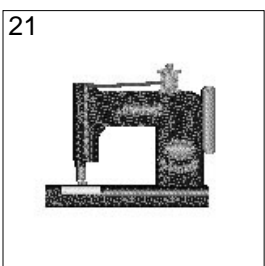
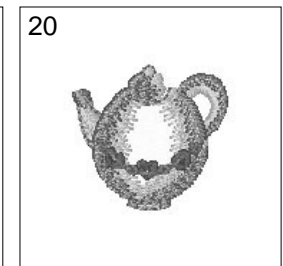
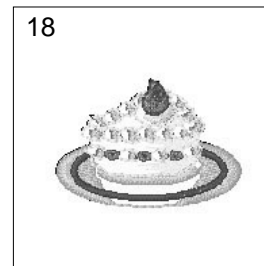
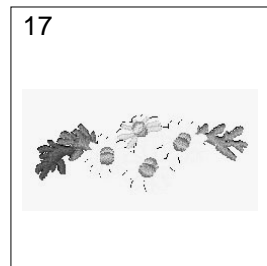
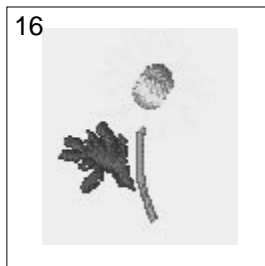
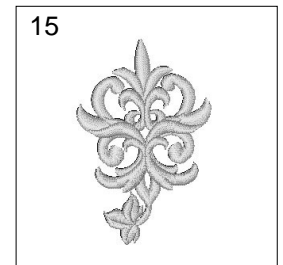
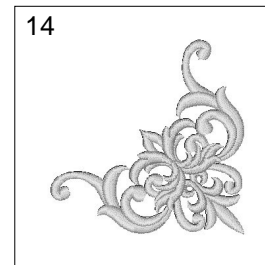
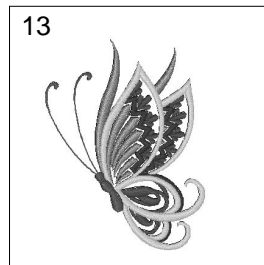
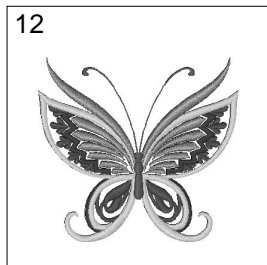
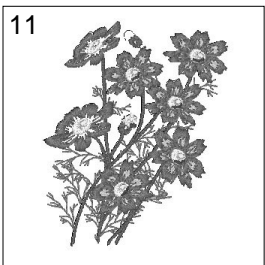
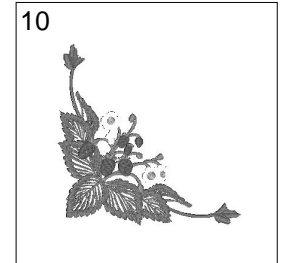
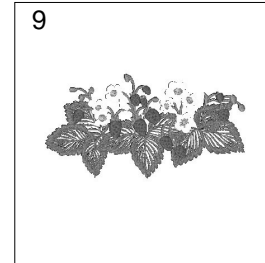
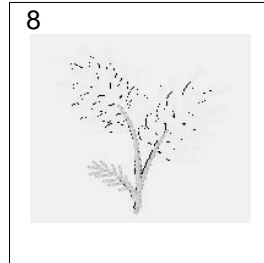
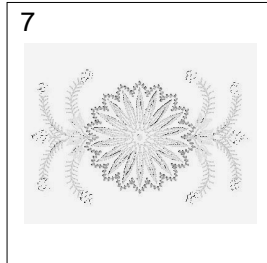
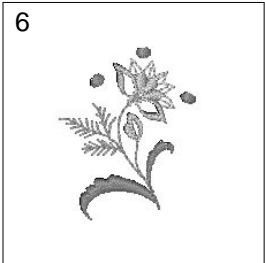
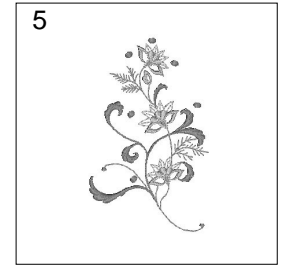
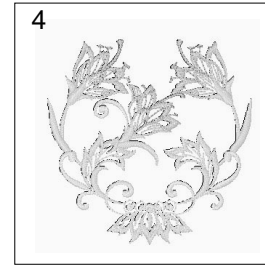
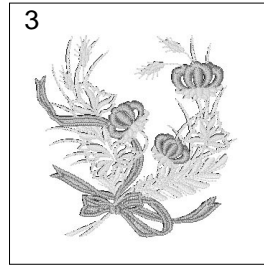
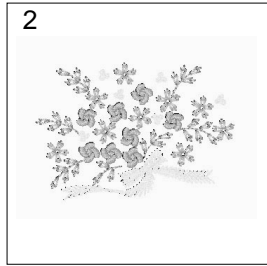
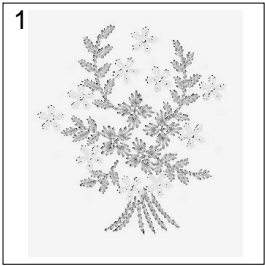

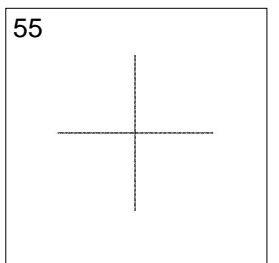
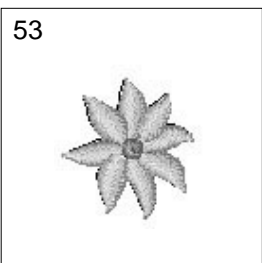
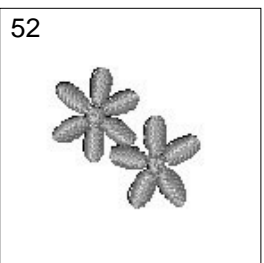
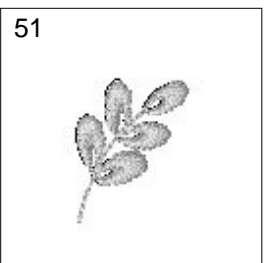
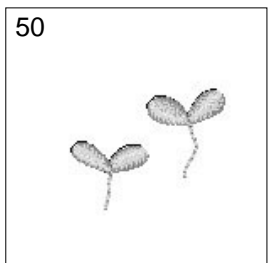
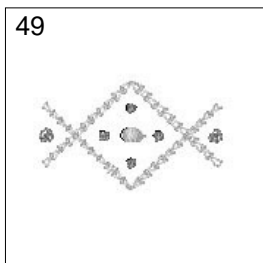
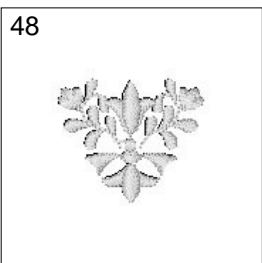
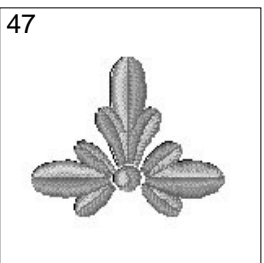
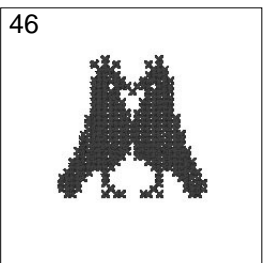
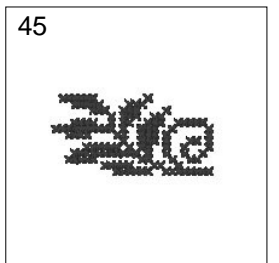
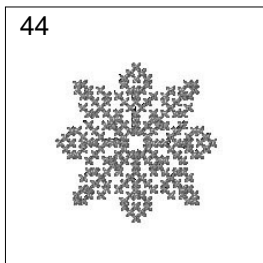
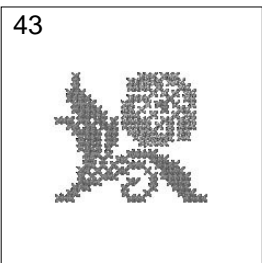
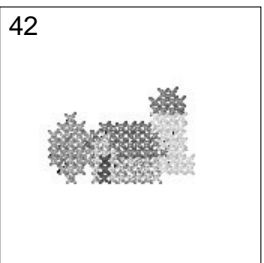
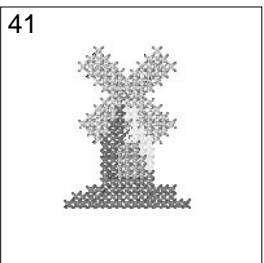
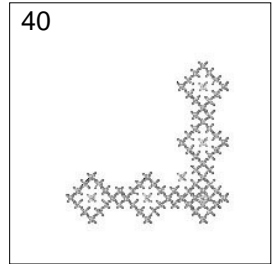
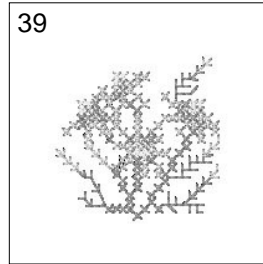
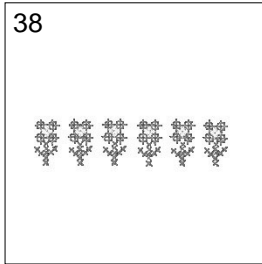
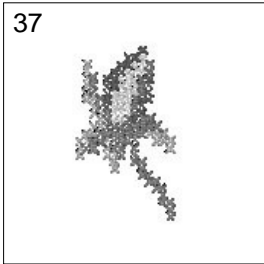
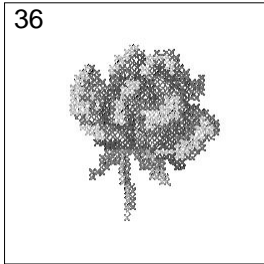
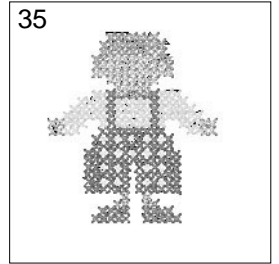
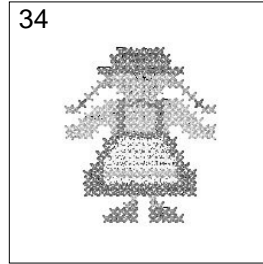
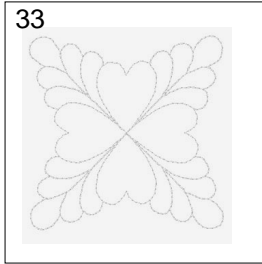
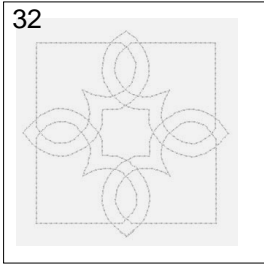
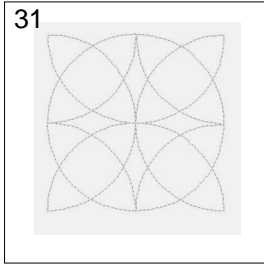

FONTS

GOTHIC

A	B	C	D	E	F	G	H	I	J	K	L	M	N	
O	P	Q	R	S	T	U	V	W	X	Y	Z	□	□	.
a	b	c	d	e	f	g	h	i	j	k	l	m	n	
o	p	q	r	s	t	u	v	w	x	y	z	□	□	.
0	1	2	3	4	5	6	7	8	9	&	_	\$	@	
.	•	,	?	¿	!	¡	'	'	<	>	-			
Ä	Â	Á	À	Ã	Å	Ë	Ê	É	È	Ï	Î	Í	Ì	Ñ
Ö	Ô	Ó	Ò	Õ	Ü	Û	Ú	Ù	Æ	Œ	Ç	Ø	ß	
ä	â	á	à	ã	å	ë	ê	é	è	ï	î	í	ì	ñ
ö	ô	ó	ò	õ	ü	û	ú	ù	æ	ij	œ	ç	ø	ß

SCRIPT

<i>A</i>	<i>B</i>	<i>C</i>	<i>D</i>	<i>E</i>	<i>F</i>	<i>G</i>	<i>H</i>	<i>I</i>	<i>J</i>	<i>K</i>	<i>L</i>	<i>M</i>	<i>N</i>	
<i>O</i>	<i>P</i>	<i>Q</i>	<i>R</i>	<i>S</i>	<i>T</i>	<i>U</i>	<i>V</i>	<i>W</i>	<i>X</i>	<i>Y</i>	<i>Z</i>	□	□	.
<i>a</i>	<i>b</i>	<i>c</i>	<i>d</i>	<i>e</i>	<i>f</i>	<i>g</i>	<i>h</i>	<i>i</i>	<i>j</i>	<i>k</i>	<i>l</i>	<i>m</i>	<i>n</i>	
<i>o</i>	<i>p</i>	<i>q</i>	<i>r</i>	<i>s</i>	<i>t</i>	<i>u</i>	<i>v</i>	<i>w</i>	<i>x</i>	<i>y</i>	<i>z</i>	□	□	.
<i>0</i>	<i>1</i>	<i>2</i>	<i>3</i>	<i>4</i>	<i>5</i>	<i>6</i>	<i>7</i>	<i>8</i>	<i>9</i>	<i>&</i>	<i>_</i>	<i>\$</i>	<i>@</i>	
<i>.</i>	<i>•</i>	<i>,</i>	<i>?</i>	<i>¿</i>	<i>!</i>	<i>¡</i>	<i>'</i>	<i>'</i>	<i><</i>	<i>></i>	<i>-</i>			
<i>Ä</i>	<i>Â</i>	<i>Á</i>	<i>À</i>	<i>Ã</i>	<i>Å</i>	<i>Ë</i>	<i>Ê</i>	<i>É</i>	<i>È</i>	<i>Ï</i>	<i>Î</i>	<i>Í</i>	<i>Ì</i>	<i>Ñ</i>
<i>Ö</i>	<i>Ô</i>	<i>Ó</i>	<i>Ò</i>	<i>Õ</i>	<i>Ü</i>	<i>Û</i>	<i>Ú</i>	<i>Ù</i>	<i>Æ</i>	<i>Œ</i>	<i>Ç</i>	<i>Ø</i>	<i>ß</i>	
<i>ä</i>	<i>â</i>	<i>á</i>	<i>à</i>	<i>ã</i>	<i>å</i>	<i>ë</i>	<i>ê</i>	<i>é</i>	<i>è</i>	<i>ï</i>	<i>î</i>	<i>í</i>	<i>ì</i>	<i>ñ</i>
<i>ö</i>	<i>ô</i>	<i>ó</i>	<i>ò</i>	<i>õ</i>	<i>ü</i>	<i>û</i>	<i>ú</i>	<i>ù</i>	<i>æ</i>	<i>ij</i>	<i>œ</i>	<i>ç</i>	<i>ø</i>	<i>ß</i>

CHELTENHAM

A	B	C	D	E	F	G	H	I	J	K	L	M	N	
O	P	Q	R	S	T	U	V	W	X	Y	Z	□	□	.
a	b	c	d	e	f	g	h	i	j	k	l	m	n	
o	p	q	r	s	t	u	v	w	x	y	z	□	□	.
0	1	2	3	4	5	6	7	8	9	&	_	\$	@	
.	•	,	?	¿	!	¡	'	'	<	>	-			
Ä	Â	Á	À	Ã	Å	Ë	Ê	É	È	Ï	Î	Í	Ì	Ñ
Ö	Ô	Ó	Ò	Õ	Ü	Û	Ú	Ù	Æ	Œ	Ç	Ø	ß	
ä	â	á	à	ã	å	ë	ê	é	è	ï	î	í	ì	ñ
ö	ô	ó	ò	õ	ü	û	ú	ù	æ	ij	œ	ç	ø	ß

BORDER DESIGNS

