

**Quick reference guide**  
**Kurzanleitung**  
**Guide de référence rapide**  
**Beknopte bedieningsgids**  
**Guida di riferimento rapido**  
**Guía de referencia rápida**  
**Краткий справочник**

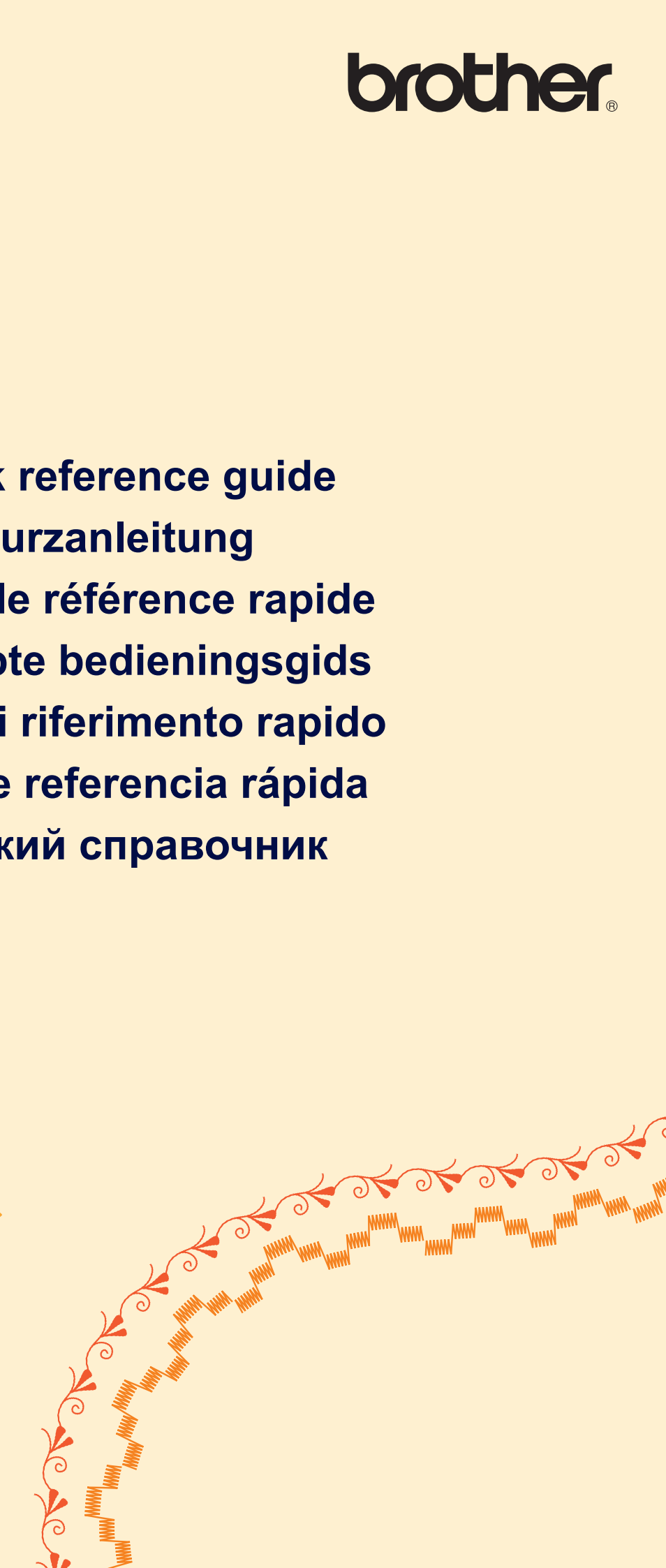

Refer to the operation manual for detailed instruction.

Also, there are differences in the keys and screens depending on the display language. In this guide, English screens are used for basic explanations.

Einzelheiten entnehmen Sie bitte der Bedienungsanleitung.

Je nachdem, welche Sprache für die Bildschirmanzeigen gewählt wurde, ergeben sich im Hinblick auf Bildschirmbilder eventuell Unterschiede. Die grundlegende Bedienung der Maschine ist in dieser Anleitung am Beispiel von Bildschirmbildern mit englischem Text erklärt.

Pour les instructions détaillées, voir le mode d'emploi.

Par ailleurs, il y a des différences dans les touches et les écrans en fonction de la langue d'affichage. Dans ce guide, les explications de base utilisent les écrans anglais.

Zie de gebruiksaanwijzing voor gedetailleerde instructies.

Er zijn verschillen in de toetsen en schermen afhankelijk van de ingestelde taal. In de beschrijvingen in deze beknopte handleiding worden de Engelse schermen gebruikt.

Fare riferimento al manuale di impiego per istruzioni dettagliate.

Inoltre, ci sono differenze nei tasti e nelle schermate a seconda della lingua visualizzata. In questa guida, le schermate in inglese sono usate per le spiegazioni basilari.

Consulte el manual de instrucciones para ver más detalles.

Además, dependiendo del idioma visualizado algunos botones y pantallas podrán ser diferentes. En esta guía, para las explicaciones básicas se emplean pantallas en inglés.

Более подробная информация представлена в руководстве по эксплуатации.

Кроме того, в зависимости от языка сообщений на ЖК-дисплее названия кнопок и другая информация на экранах могут иметь некоторые различия. В настоящем справочнике основные пояснения даются на примере экранов с информацией на английском языке.

<English display>  
<Englische Anzeige>  
<Affichage en anglais>  
<Engels scherm>  
<Schermata in inglese>  
<Visualización en inglés>  
<Экран: английский язык>

<Example: German>  
<Beispiel: Deutsch>  
<Exemple : allemand>  
<Voorbeeld: Duits>  
<Esempio: Tedesco>  
<Ejemplo: Alemán>  
<Пример: немецкий язык>

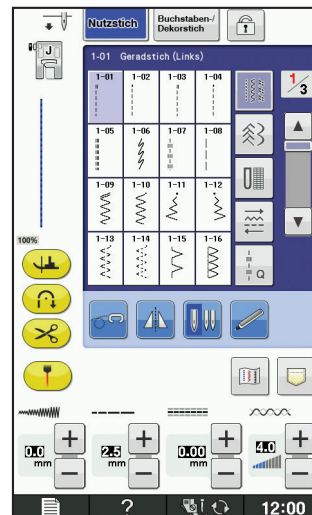
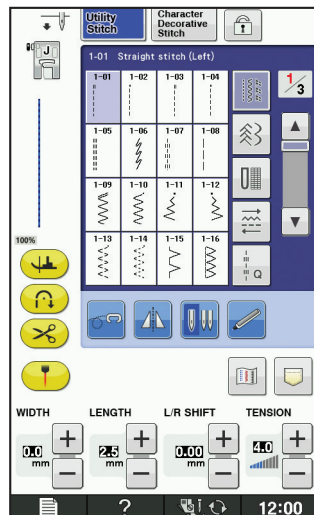

## Contents

Winding the Bobbin .....	2
Setting the Bobbin .....	4
Upper Threading .....	5
Selecting Stitch Patterns .....	6
Summary of Stitch Patterns .....	10

## Table des matières

Bobinage de la canette .....	2
Mise en place de la canette .....	4
Enfilage supérieur .....	5
Sélection des configurations de point .....	6
Sommaire des motifs de point .....	10

## Sommario

Avvolgimento della spolina .....	2
Impostazione della spolina .....	4
Infilatura superiore .....	5
Selezione degli schemi punto .....	6
Sommario degli schemi punto .....	10

## Содержание

Намотка шпульки .....	2
Установка шпульки .....	4
Заправка верхней нити .....	5
Выбор строчки .....	6
Виды строчек .....	10

## Inhalt

Aufspulen des Unterfadens .....	2
Einsetzen der Spule .....	4
Einfädeln des Oberfadens .....	5
Wahl des Nähmusters .....	6
Nähmuster-Übersicht .....	10

## Inhoudsopgave

Spoel opwinden .....	2
Aanbrengen van het spoeltje .....	4
Inrijgen van de bovendraad .....	5
Kiezen van de steekpatronen .....	6
Overzicht van de steekpatronen .....	10

## Contenido

Devanado de la bobina .....	2
Colocación de la bobina .....	4
Hilo superior .....	5
Selección de tipos de puntada .....	6
Resumen de tipos de puntada .....	10

# Winding the Bobbin

## Bobinage de la canette

### Avvolgimento della spolina

### Намотка шпульки

# Aufspulen des Unterfadens

## Spoel opwinden

### Devanado de la bobina

Follow the numbered steps below in order. Refer to the operation manual for detailed instruction.

Führen Sie die folgenden Schritte in der angegebenen Reihenfolge aus. Ausführliche Hinweise finden Sie in der Bedienungsanleitung.

Suivez les étapes numérotées ci-dessous dans l'ordre. Consultez le manuel d'instructions pour des procédures détaillées.

Voer de genummerde stappen uit in de juiste volgorde. Uitvoerige aanwijzingen vindt u in de bedieningshandleiding.

Seguire i passaggi numerati nell'ordine riportato di seguito. Fare riferimento al manuale d'istruzioni per le istruzioni dettagliate.

Realice los siguientes pasos numerados en el orden indicado. Para obtener instrucciones detalladas, consulte el manual de instrucciones.

Выполните приведенные ниже операции в порядке их нумерации. Более подробная информация представлена в руководстве по эксплуатации.

Use only the enclosed bobbin or bobbins of the same type.

Verwenden Sie nur die im Lieferumfang enthaltene Spule oder Spulen vom selben Typ.

N'utilisez que la canette fournie ou des canettes du même type.

Gebruik alleen de bijgeleverde spoel of spoelen van hetzelfde type.

Utilizzare solo la spolina inclusa o spoline dello stesso tipo.

Utilice sólo la bobina incluida o bobinas del mismo tipo.

Применяйте только прилагаемые к машине шпульки или шпульки того же типа.

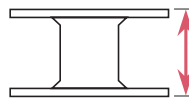

11.5 mm (approx. 7/16 inch)  
(ca. 7/16 Zoll)  
(env. 7/16 po)

11,5 mm (ca. 7/16 inch)  
(circa 7/16 in.)  
(aprox. 7/16 pulg.)  
(прим. 7/16 дюйма)

#### ◆ Using the Supplemental Spool Pin

You can wind the bobbin during sewing.

#### ◆ Utilisation du porte-bobine supplémentaire

Vous pouvez bobiner la canette pendant la couture.

#### ◆ Utilizzo del portarocchetto supplementare

È possibile avvolgere la spolina durante la cucitura.

#### ◆ Использование дополнительного стержня для катушки

Можно наматывать нить на шпульку во время шитья.

#### ◆ Verwendung des zusätzlichen Garnrollenstifts

Sie können den Unterfaden während des Nähens aufspulen.

#### ◆ Gebruik van de klospen

U kunt de spoel opwinden tijdens het naaien.

#### ◆ Uso del portacarrete suplementario

Puede devanar la bobina mientras está cosiendo.

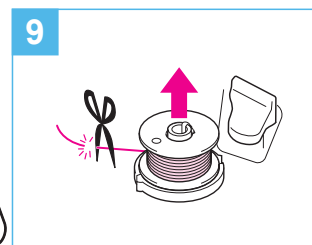
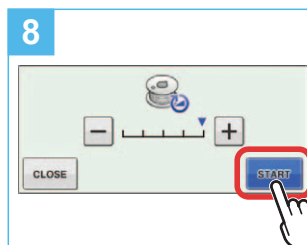
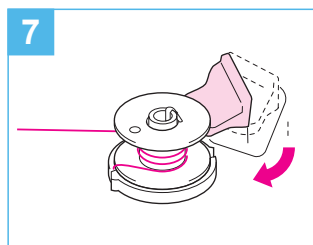
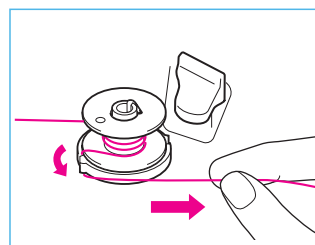
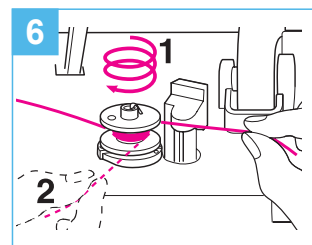
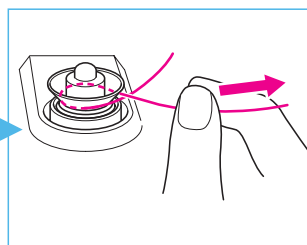
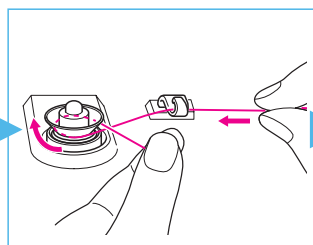
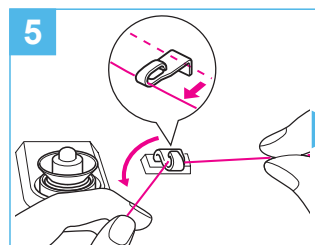
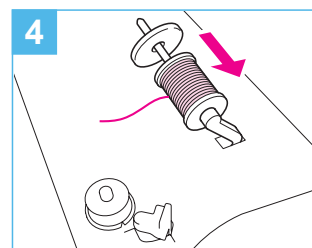
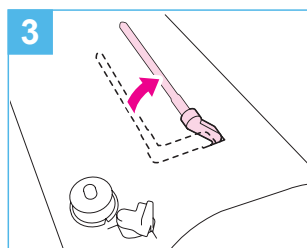
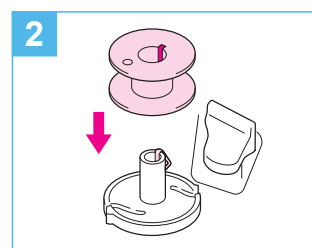
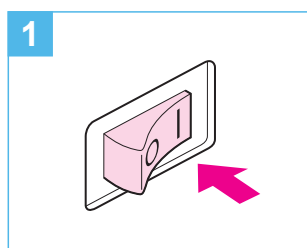
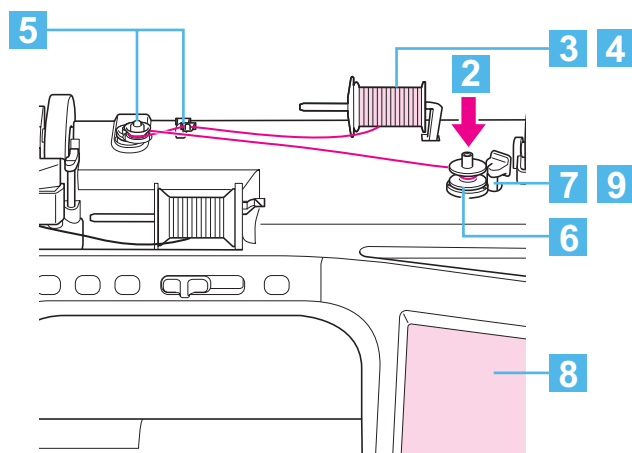



### ◆ Using the Spool Pin

You can use the main spool pin to wind the bobbin before sewing.

### ◆ Utilisation du porte-bobine

Vous pouvez bobiner la canette avant de coudre à l'aide du porte-bobine principal.

### ◆ Utilizzo del portarocchetto

È possibile utilizzare il portarocchetto principale per avvolgere la spolina prima di cucire.

### ◆ Использование основного стержня для катушки

Для намотки шпульки перед шитьем можно использовать главный стержень для катушки.

### ◆ Verwendung des Garnrollenstifts

Mit dem Hauptgarnrollenstift können Sie vor dem Nähen den Unterfaden aufspulen.

### ◆ Gebruik van de klospen

Voordat u gaat naaien kunt u met de hoofdklospen de spoel opwinden.

### ◆ Uso del portacarrete

Puede utilizar el portacarrete principal para devanar la bobina antes de coser.

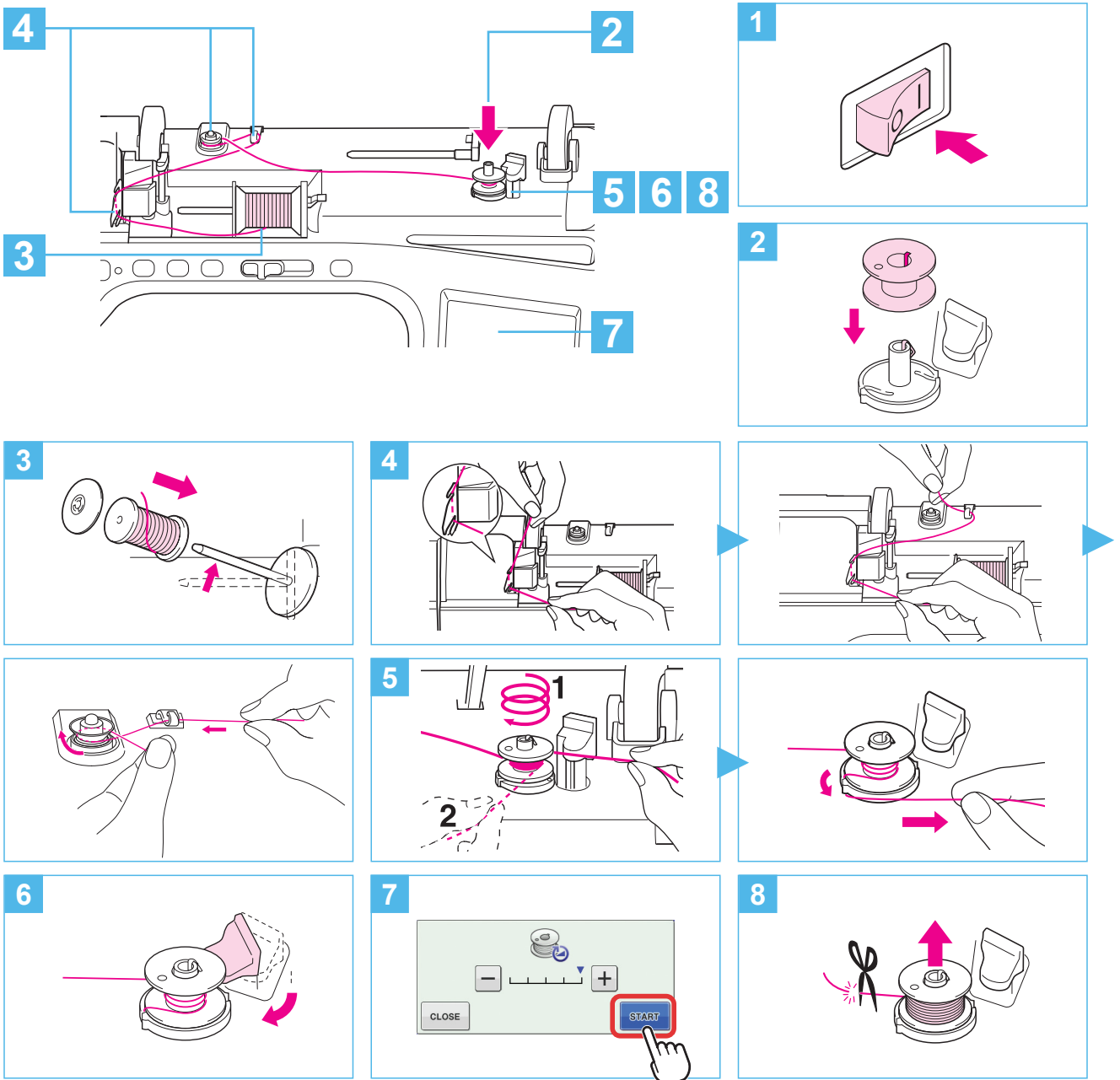

# Setting the Bobbin

## Mise en place de la canette

## Impostazione della spolina

## Установка шпульки

# Einsetzen der Spule

## Aanbrengen van het spoeltje

## Colocación de la bobina

Refer to the operation manual for detailed instruction.  
Pour les instructions détaillées, voir le mode d'emploi.  
Fare riferimento al manuale di impiego per istruzioni dettagliate.  
Подробная информация: см. в руководстве по эксплуатации

Einzelheiten hierzu entnehmen Sie bitte der Bedienungsanleitung.  
Zie de gebruiksaanwijzing voor gedetailleerde instructies.  
Consulte el manual de instrucciones para ver más detalles.

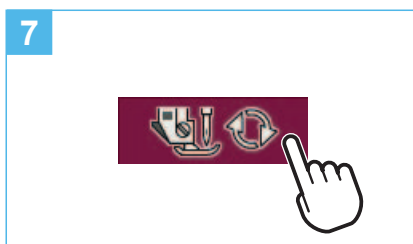
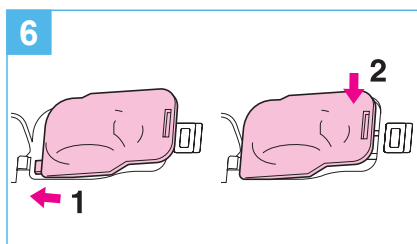
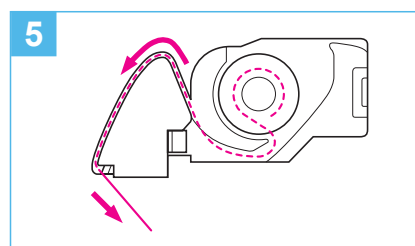
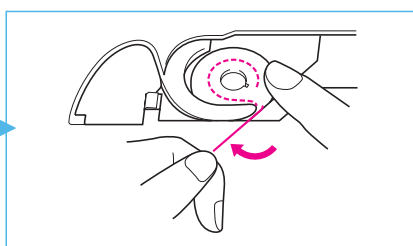
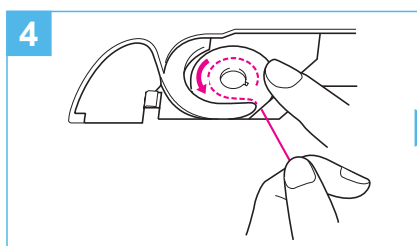
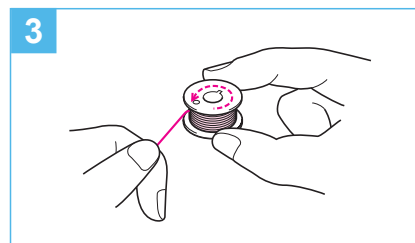
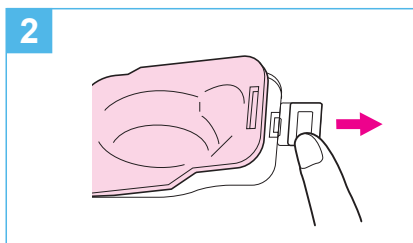
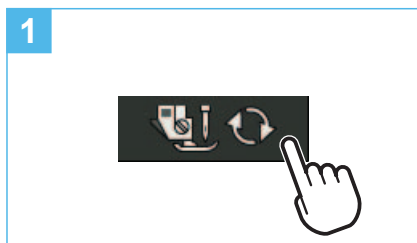

**Upper Threading**  
**Enfilage supérieur**  
**Infilatura superiore**  
**Заправка верхней нити**

**Einfädeln des Oberfadens**  
**Inrijgen van de bovendraad**  
**Hilo superior**

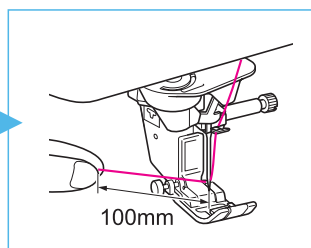
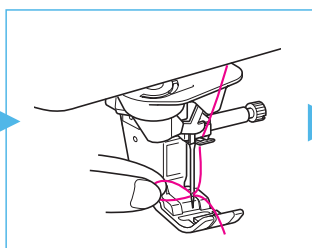
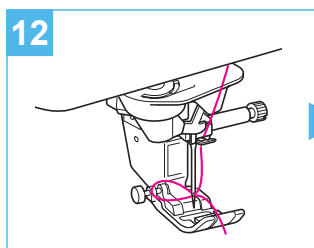
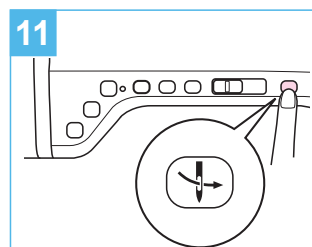
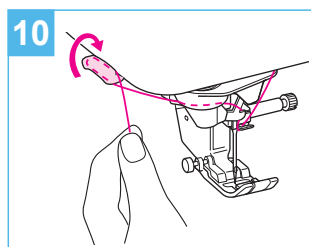
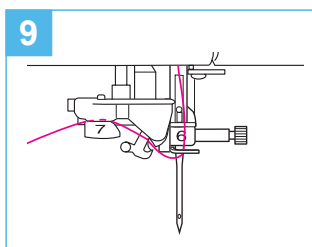
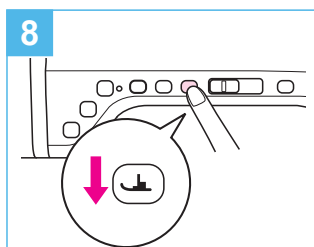
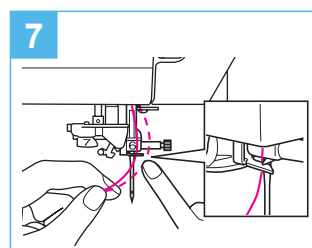
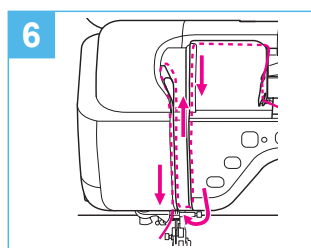
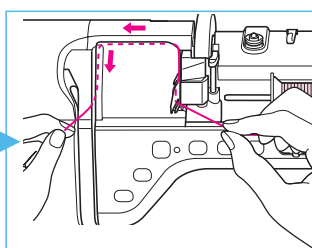
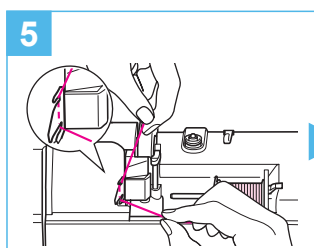
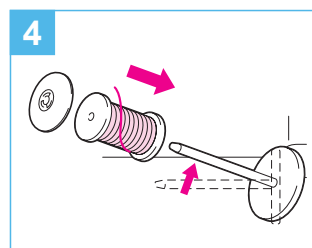
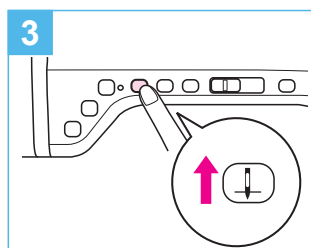
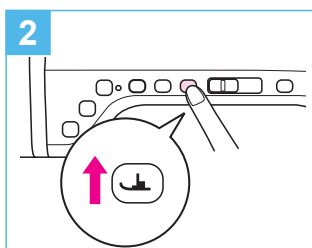
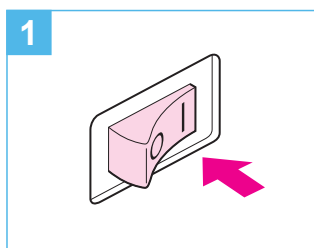
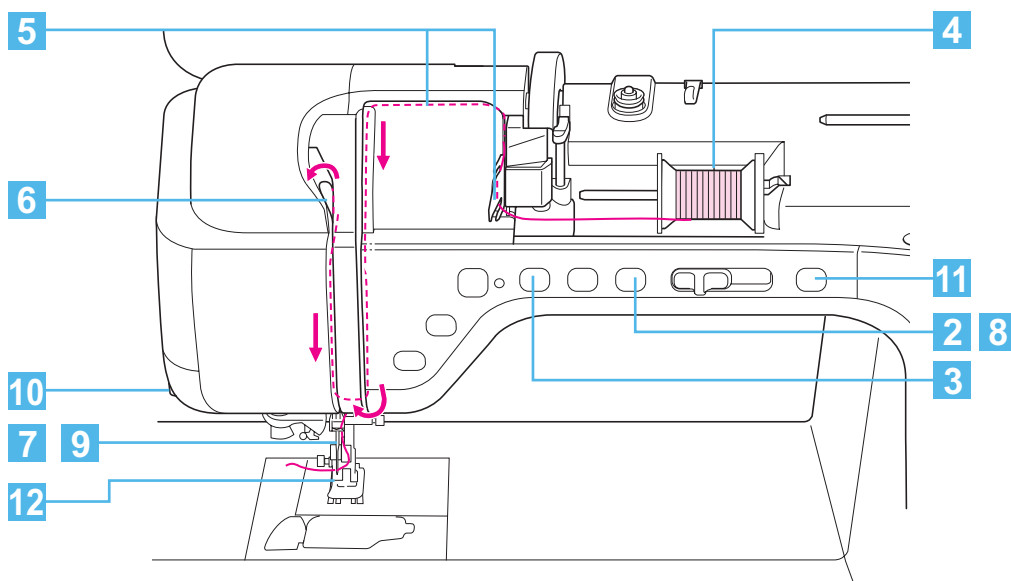

# Selecting Stitch Patterns

Sélection des configurations de point  
 Selezione degli schemi punto  
 Выбор строчки

# Wahl des Nähmusters

Kiezen van de steekpatronen  
 Selección de tipos de puntada

- ◆ LCD Flow Chart
- ◆ Organigramme de l'écran à cristaux liquides
- ◆ Schema di flusso LCD
- ◆ Схема действий на LCD дисплее

- ◆ LCD-Übersichtsdiagramm
- ◆ LCD-stroomschema
- ◆ Diagrama de flujo del LCD

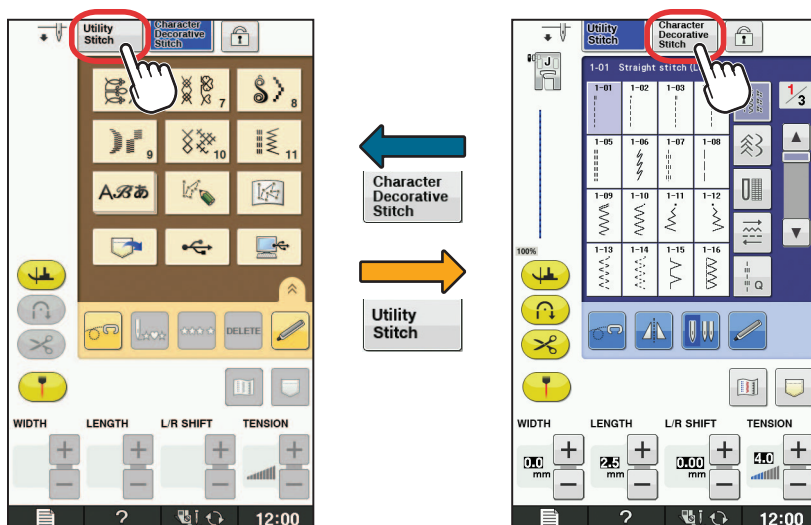

### ◆ Utility Stitches

When the machine is turned on, the opening movie is played. Touch the screen to display the Utility Stitch selection screen. Either "1-01 Straight stitch (Left)" or "1-03 Straight stitch (Middle)" is selected, depending on the setting selected in the settings screen.

### ◆ Points utiles

Quand la machine est mise sous tension, la vidéo de démarrage commence. Touchez l'écran pour afficher l'écran de sélection Point utile. Soit « 1-01 Point droit (Gauche) », soit « 1-03 Point droit (Milieu) » est sélectionné, selon le réglage sélectionné sur l'écran de réglage.

### ◆ Punti utili

All'accensione della macchina, viene riprodotto il filmato di apertura. Toccare lo schermo per visualizzare la schermata di selezione del punto utile. Viene selezionato "1-01 Punto diritto (Sinistra)" o "1-03 Punto diritto (Centro)", a seconda dell'impostazione selezionata nella schermata delle impostazioni.

### ◆ Основные строчки

После включения машины воспроизводится вступительный видеоролик. Прикоснитесь к экрану, чтобы отобразить экран выбора основной строчки. В зависимости от настройки, выбранной на экране настроек, будет выбрана строчка "1-01: Прямая строчка Игла слева" или "1-03: Прямая строчка Игла по центру".

### ◆ Nutzstiche

Nach dem Einschalten der Maschine wird der Eingangsfilm angezeigt. Berühren Sie den Bildschirm zur Anzeige des Auswahlbildschirms für den Nutzstich. Je nach Einstellung im Einstellungsbildschirm ist „1-01 Geradstich (Links)“ oder „1-03 Geradstich (Mitte)“ ausgewählt.

### ◆ Naaisteken

Wanneer u de machine aanzet, wordt de openingsfilm afgespeeld. Raak het scherm aan om het naaistekenoverzicht weer te geven. Afhankelijk van de geselecteerde instelling in het instellingenschermbord wordt ofwel "1-01 Rechte steek (links)" of "1-03 Rechte steek (midden)" geselecteerd.

### ◆ Puntadas utiles

Quando se activa la máquina, se reproduce el vídeo de presentación. Toque la pantalla para visualizar la pantalla de selección de puntada con aplicaciones. Se seleccionará la "Puntada recta 1-01 (izquierda)" o la "Puntada recta 1-03 (medio)", según el ajuste seleccionado en la pantalla de ajustes.

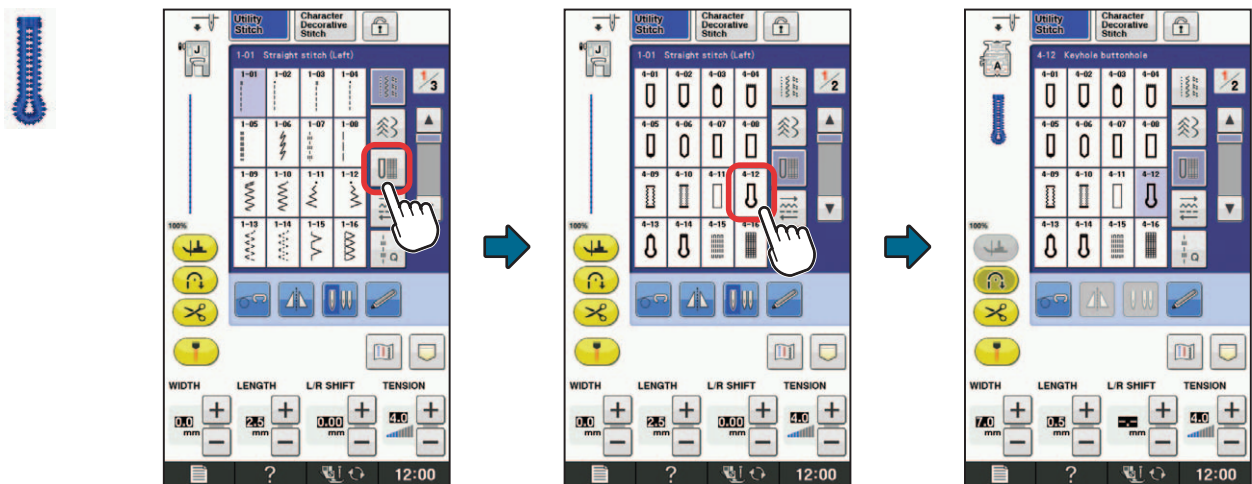

- ◆ Character/Decorative Stitches
- ◆ Caractères/points décoratifs
- ◆ Puntis per caratteri/decorazioni
- ◆ Знаки алфавита/декоративные строчки

- ◆ Buchstaben/Dekorative Stichmuster
- ◆ Letter/decoratieve steken
- ◆ Puntadas de letras/decorativas

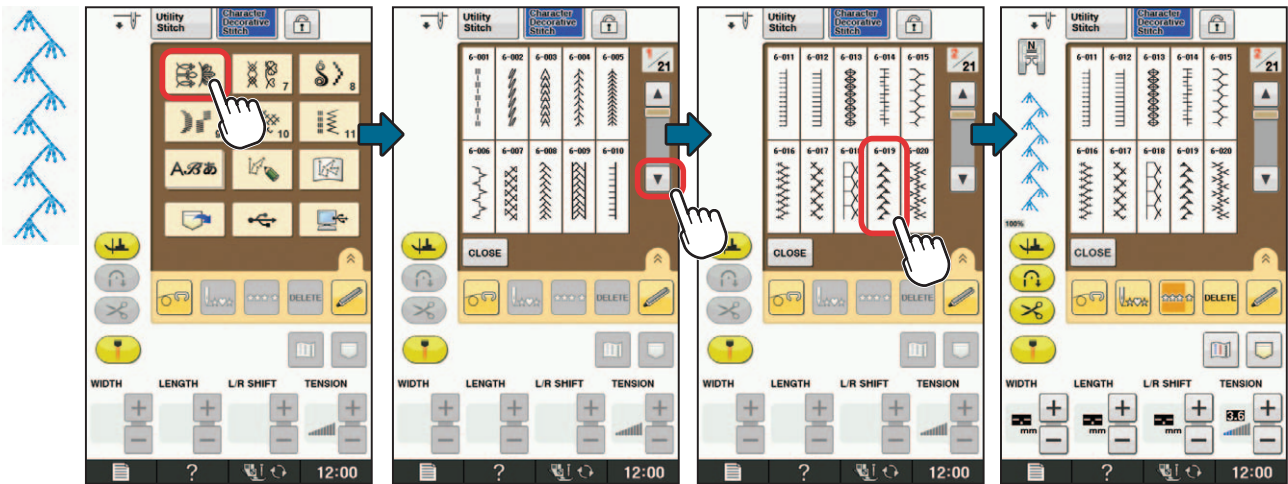

- ◆ Settings
- ◆ Réglages
- ◆ Impostazioni
- ◆ Настройки

- ◆ Einstellungen
- ◆ Instellingen
- ◆ Ajustes

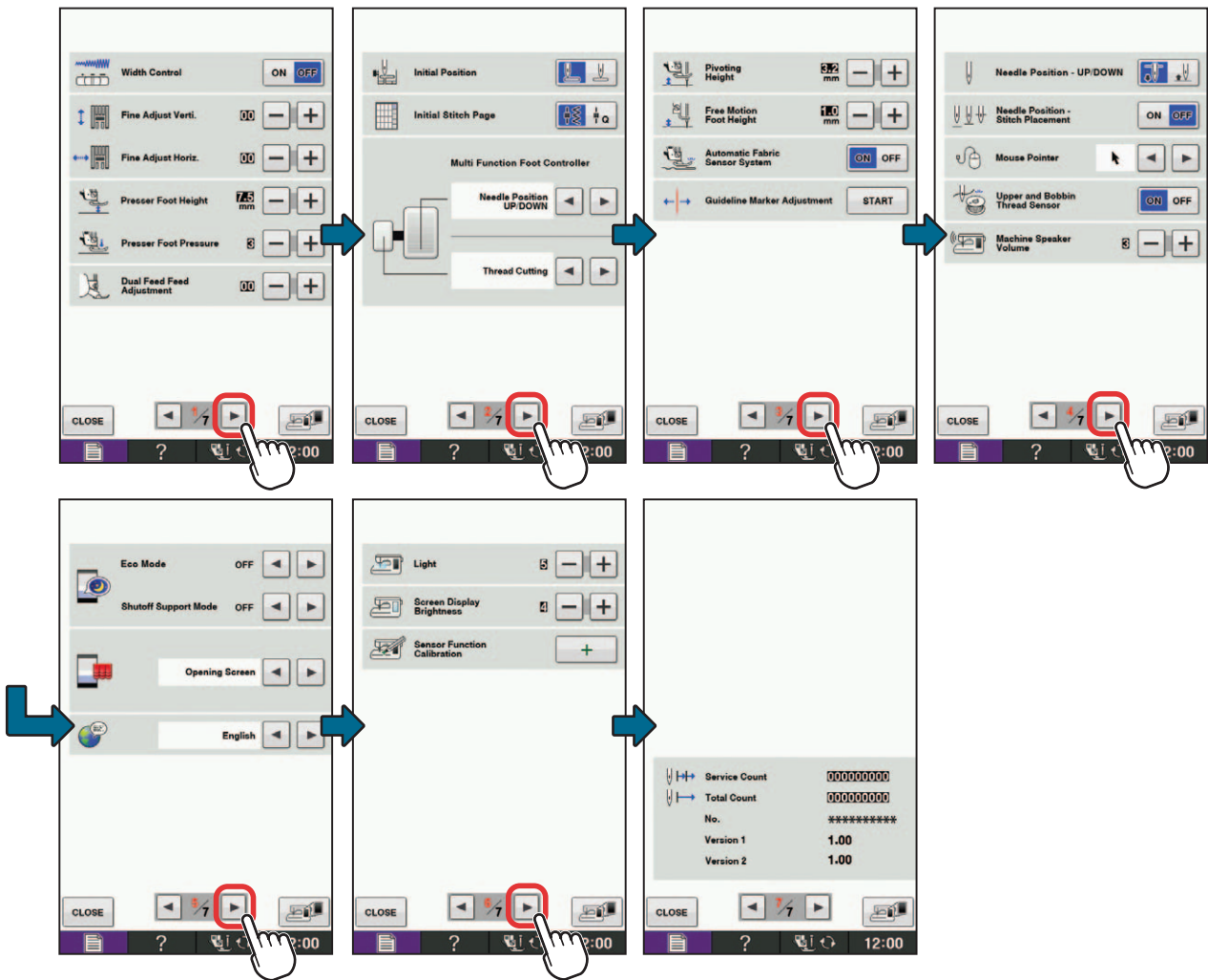



Summary of Stitch Patterns  
 Sommaire des motifs de point  
 Sommario degli schemi punto  
 Виды строчек

Nähmuster-Übersicht  
 Overzicht van de steekpatronen  
 Resumen de tipos de puntada

◆ Utility Stitches

◆ Points utiles

◆ Punti utili

◆ Основные строчки

◆ Nutzstiche

◆ Naaisteken

◆ Puntadas utiles

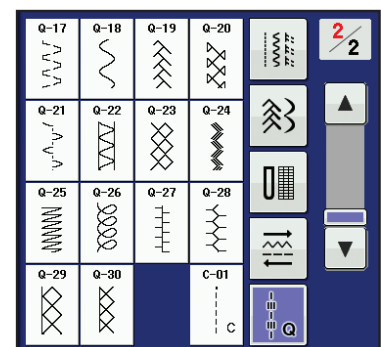
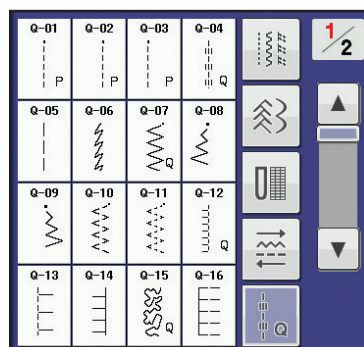
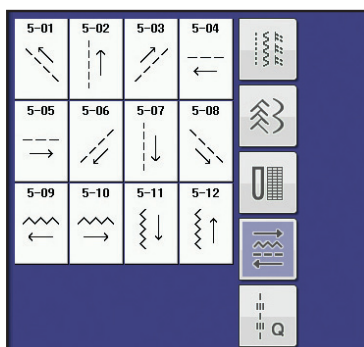
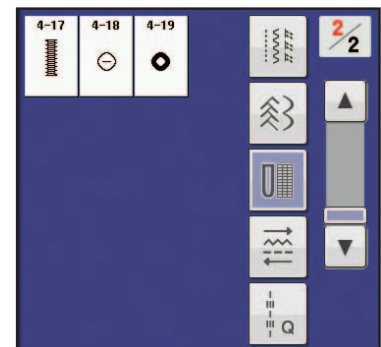
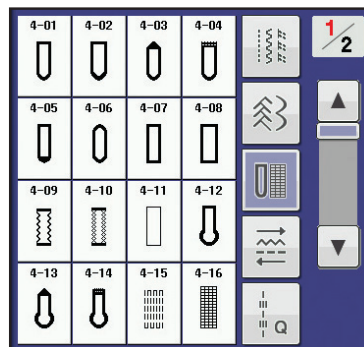
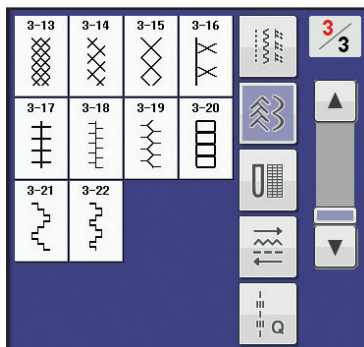
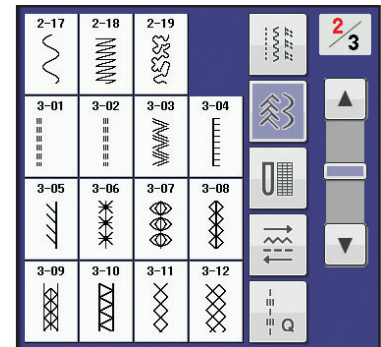
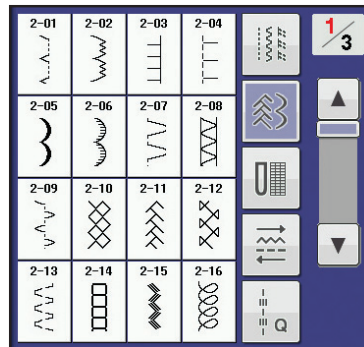
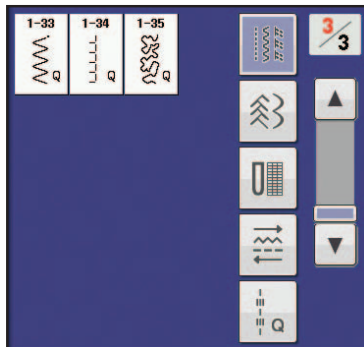
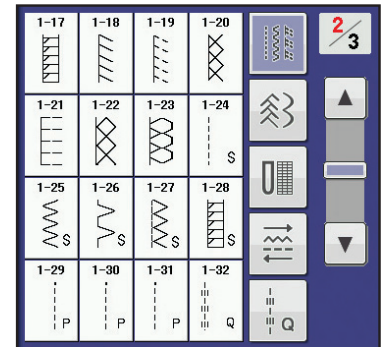
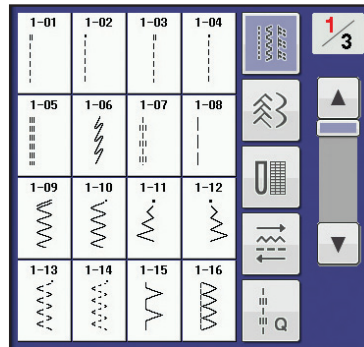
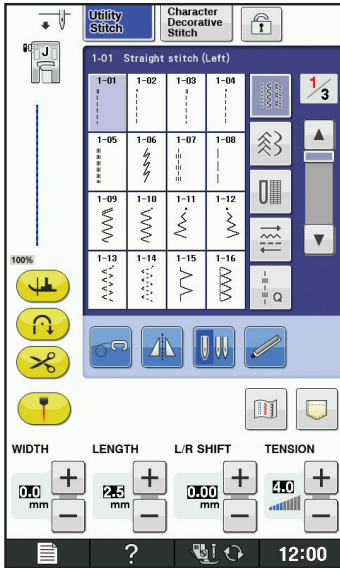

◆ Character/Decorative Stitches

◆ Caractères/points décoratifs

◆ Punti per caratteri/decorazioni

◆ Знаки алфавита/декоративные строчки

◆ Buchstaben/Dekorative Stichmuster

◆ Letter/decoratieve steken

◆ Puntadas de letras/decorativas

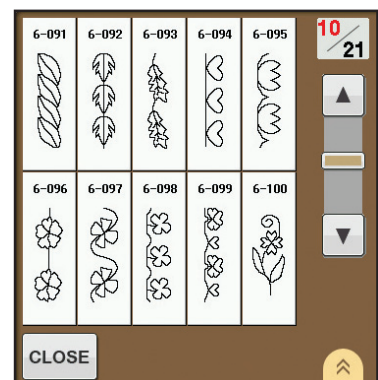
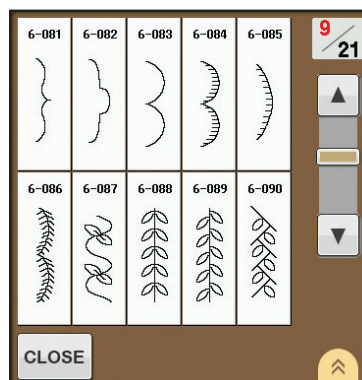
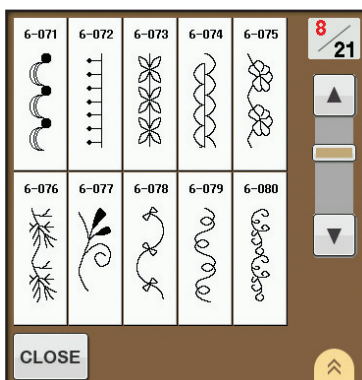
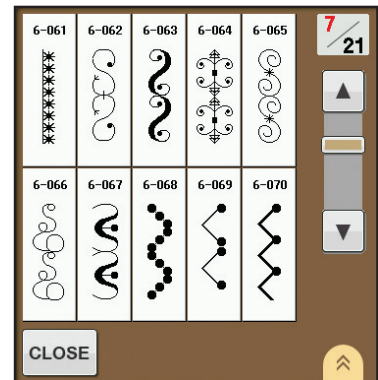
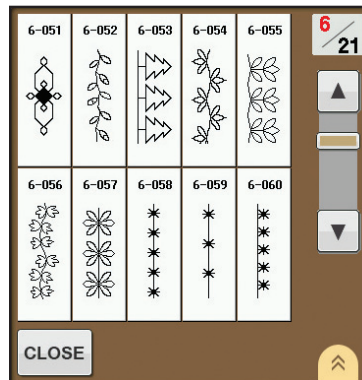
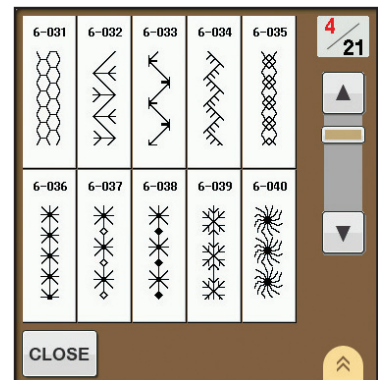
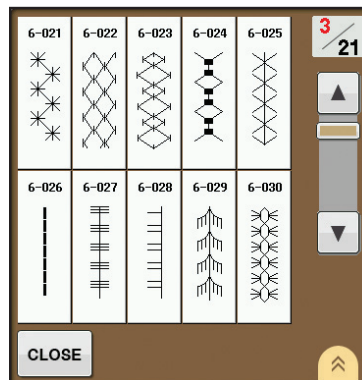
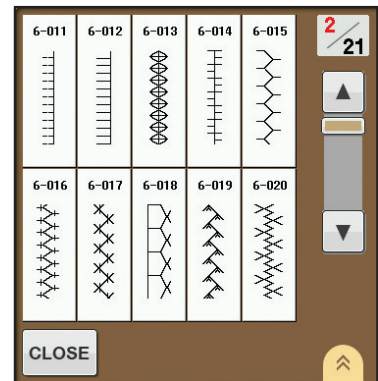
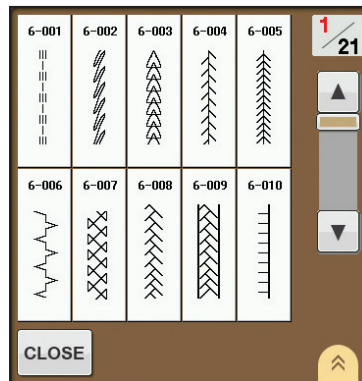
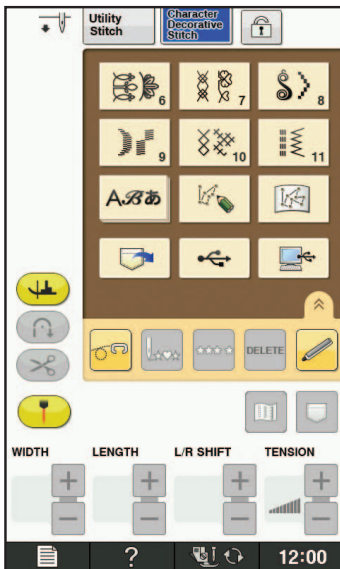

6-101	6-102	6-103	6-104	6-105	11 / 21
6-106	6-107	6-108	6-109	6-110	
CLOSE					

6-111	6-112	6-113	6-114	6-115	12 / 21
6-116	6-117	6-118	6-119	6-120	
CLOSE					

6-121	6-122	6-123	6-124	6-125	13 / 21
6-126	6-127	6-128	6-129	6-130	
CLOSE					

6-131	6-132	6-133	6-134	6-135	14 / 21
6-136	6-137	6-138	6-139	6-140	
CLOSE					

6-141	6-142	6-143	6-144	6-145	15 / 21
6-146	6-147	6-148	6-149	6-150	
CLOSE					

6-151	6-152	6-153	6-154	6-155	16 / 21
6-156	6-157	6-158	6-159	6-160	
CLOSE					

6-161	6-162	6-163	6-164	6-165	17 / 21
6-166	6-167	6-168	6-169	6-170	
CLOSE					

6-171	6-172	6-173	6-174	6-175	18 / 21
6-176					
CLOSE					

6-177	6-178	6-179			19 / 21
CLOSE					



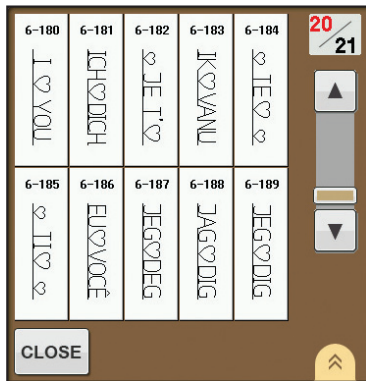

6-180: English  
 6-181: German  
 6-182: French  
 6-183: Dutch  
 6-184: Spanish  
 6-185: Italian  
 6-186: Portuguese  
 6-187: Norwegian  
 6-188: Swedish  
 6-189: Danish  
 6-190: Finnish  
 6-191: Russian  
 6-192: Thai  
 6-193: Simplified Chinese  
 6-194: Japanese

6-180: Englisch  
 6-181: Deutsch  
 6-182: Französisch  
 6-183: Niederländisch  
 6-184: Spanisch  
 6-185: Italienisch  
 6-186: Portugiesisch  
 6-187: Norwegisch  
 6-188: Schwedisch  
 6-189: Dänisch  
 6-190: Finnisch  
 6-191: Russisch  
 6-192: Thailändisch  
 6-193: Vereinfachtes Chinesisch  
 6-194: Japanisch

6-180 : anglais  
 6-181 : allemand  
 6-182 : français  
 6-183 : néerlandais  
 6-184 : espagnol  
 6-185 : italien  
 6-186 : portugais  
 6-187 : norvégien  
 6-188 : suédois  
 6-189 : danois  
 6-190 : finnois  
 6-191 : russe  
 6-192 : thaïlandais  
 6-193 : chinois simplifié  
 6-194 : japonais

6-180: Engels  
 6-181: Duits  
 6-182: Frans  
 6-183: Nederlands  
 6-184: Spaans  
 6-185: Italiaans  
 6-186: Portugees  
 6-187: Noors  
 6-188: Zweeds  
 6-189: Deens  
 6-190: Fins  
 6-191: Russisch  
 6-192: Thais  
 6-193: Vereenvoudigd Chinees  
 6-194: Japans

6-180: Inglese  
 6-181: Tedesco  
 6-182: Francese  
 6-183: Olandese  
 6-184: Spagnolo  
 6-185: Italiano  
 6-186: Portoghese  
 6-187: Norvegese  
 6-188: Svedese  
 6-189: Danese  
 6-190: Finlandese  
 6-191: Russo  
 6-192: Tailandese  
 6-193: Cinese semplificato  
 6-194: Giapponese

6-180: Inglés  
 6-181: Alemán  
 6-182: Francés  
 6-183: Holandés  
 6-184: Español  
 6-185: Italiano  
 6-186: Portugués  
 6-187: Noruego  
 6-188: Sueco  
 6-189: Danés  
 6-190: Finés  
 6-191: Ruso  
 6-192: Tailandés  
 6-193: Chino simplificado  
 6-194: Japonés

6-180: Английский  
 6-181: Немецкий  
 6-182: Французский  
 6-183: Нидерландский  
 6-184: Испанский  
 6-185: Итальянский  
 6-186: Португальский  
 6-187: Норвежский  
 6-188: Шведский  
 6-189: Датский  
 6-190: Финский  
 6-191: Русский  
 6-192: Тайский  
 6-193: Китайский (упрощенный)  
 6-194: Японский

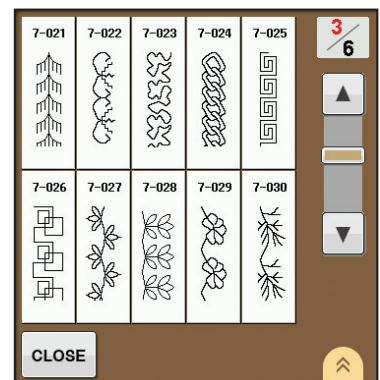
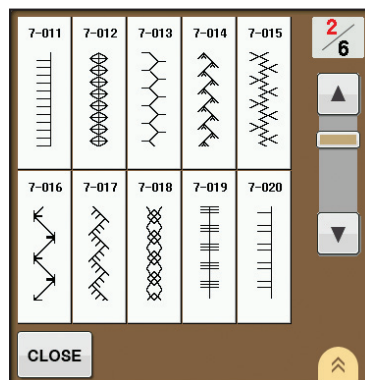
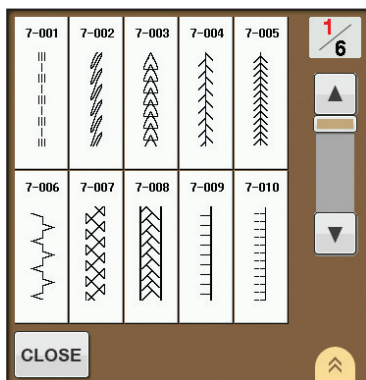
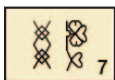

7-031	7-032	7-033	7-034	7-035	4/6	▲	▼	⏪	⏩
7-036	7-037	7-038	7-039	7-040	CLOSE				

7-041	7-042	7-043	7-044	7-045	5/6	▲	▼	⏪	⏩
7-046	7-047	7-048	7-049	7-050	CLOSE				

7-051	7-052				6/6	▲	▼	⏪	⏩
CLOSE									



8-01	8-02	8-03	8-04	8-05	1/6	▲	▼	⏪	⏩
8-06	8-07	8-08	8-09	8-10	CLOSE				

8-11	8-12	8-13	8-14	8-15	2/6	▲	▼	⏪	⏩
8-16	8-17	8-18	8-19	8-20	CLOSE				

8-21	8-22	8-23	8-24	8-25	3/6	▲	▼	⏪	⏩
8-26	8-27	8-28	8-29	8-30	CLOSE				

8-31	8-32	8-33	8-34	8-35	4/6	▲	▼	⏪	⏩
8-36	8-37	8-38	8-39	8-40	CLOSE				

8-41	8-42	8-43	8-44	8-45	5/6	▲	▼	⏪	⏩
8-46	8-47	8-48	8-49	8-50	CLOSE				

8-51	8-52	8-53	8-54	8-55	6/6	▲	▼	⏪	⏩
8-56					CLOSE				



9-01	9-02	9-03	9-04	9-05	9-06	▲	▼	⏪	⏩
9-07	9-08	9-09	9-10	9-11	9-12	CLOSE			
9-13	9-14	9-15	9-16	9-17	9-18				
9-19	9-20								



10-01	10-02	10-03	10-04	10-05	10-06	▲	▼	⏪	⏩
10-07	10-08	10-09	10-10	10-11	10-12	CLOSE			
10-13	10-14								

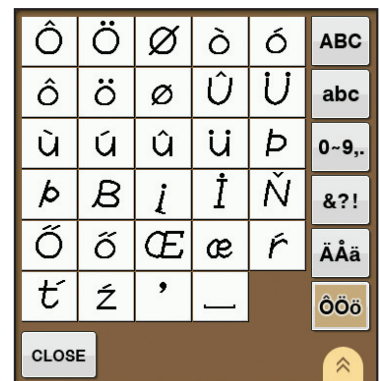
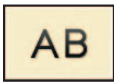
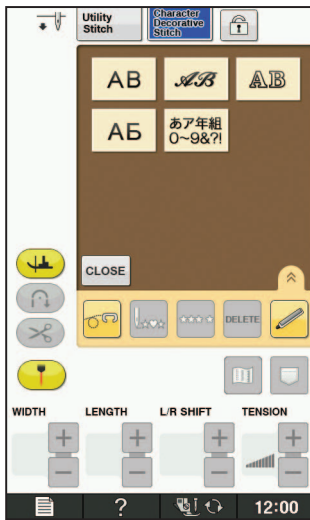
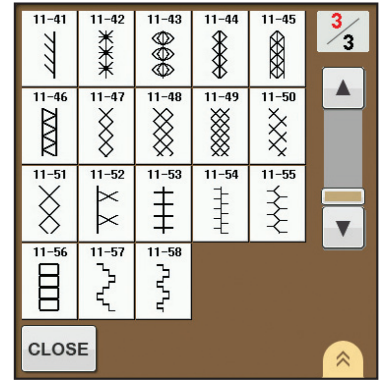
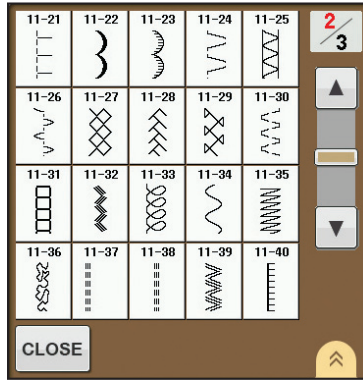
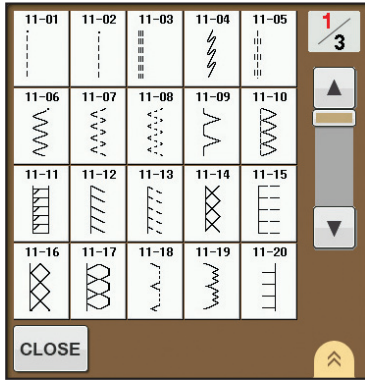

AB

A	B	C	D	E	ABC
F	G	H	I	J	abc
K	L	M	N	O	0-9,.
P	Q	R	S	T	&?!
U	V	W	X	Y	ÄÄä
Z	'	_			ÖÖö

CLOSE

a	b	c	d	e	ABC
f	g	h	i	j	abc
k	l	m	n	o	0-9,.
p	q	r	s	t	&?!
u	v	w	x	y	ÄÄä
z	'	_			ÖÖö

CLOSE

0	1	2	3	4	ABC
5	6	7	8	9	abc
#	%	\$	£	€	0-9,.
¥	-	+	×	÷	&?!
=	*	.	,	'	ÄÄä
_					ÖÖö

CLOSE

&	?	!	@	<	ABC
>	(	)	[	]	abc
/	\	~	:	;	0-9,.
©	®	™	“	”	&?!
”	'	'	'	_	ÄÄä
					ÖÖö

CLOSE

À	Á	Â	à	á	ABC
ä	ã	ä	å	Æ	abc
æ	Ç	ç	È	É	0-9,.
Ê	Ë	è	é	ê	&?!
ë	Ï	ì	í	Ð	ÄÄä
Ñ	ñ	Î	í	_	ÖÖö

CLOSE

Ô	Ö	Ø	ò	ó	ABC
ô	ö	ø	û	ü	abc
ù	ú	û	ü	Þ	0-9,.
ƒ	ß	ı	İ	Ń	&?!
Ö	ö	œ	æ	ř	ÄÄä
ť	ž	'	_		ÖÖö

CLOSE

AB

A	B	C	D	E	ABC
F	G	H	I	J	abc
K	L	M	N	O	0-9,.
P	Q	R	S	T	&?!
U	V	W	X	Y	ÄÄä
Z	'	_			ÖÖö

CLOSE

a	b	c	d	e	ABC
f	g	h	i	j	abc
k	l	m	n	o	0-9,.
p	q	r	s	t	&?!
u	v	w	x	y	ÄÄä
z	'	_			ÖÖö

CLOSE

0	1	2	3	4	ABC
5	6	7	8	9	abc
#	%	\$	£	€	0-9,.
¥	-	+	×	÷	&?!
=	*	.	,	'	ÄÄä
_					ÖÖö

CLOSE

&	?	!	@	<	ABC
>	(	)	[	]	abc
/	\	~	:	;	0-9,.
©	®	™	“	”	&?!
”	'	'	'	_	ÄÄä
					ÖÖö

CLOSE

Â	Ä	Å	à	á	ABC
â	ã	ä	å	Æ	abc
æ	Ç	ç	È	É	0-9,.
Ê	Ë	è	é	ê	&?!
ë	Ï	ì	í	Ð	ÄÄä
Ñ	ñ	Î	í	_	ÖÖö

CLOSE

Ô	Ö	Ø	ò	ó	ABC
ô	ö	ø	û	ü	abc
ù	ú	û	ü	Þ	0-9,.
ƒ	ß	ı	İ	Ń	&?!
Ö	ö	œ	æ	ř	ÄÄä
ť	ž	'	_		ÖÖö

CLOSE



АБ

А	Б	В	Г	Д	АБВ
Е	Ё	Ж	З	И	ЧШЩ
Й	К	Л	М	Н	абв
О	П	Р	С	Т	чшщ
У	Ф	Х	Ц	—	0-9,.

CLOSE 

Ч	Ш	Щ	Ь	Ы	АБВ
Ь	Э	Ю	Я	Г	ЧШЩ
Є	І	Ї	Ў	Ѓ	абв
ћ	Ј	ЈЬ	Њ	Џ	чшщ
Ѓ	Ѕ	Ї	—		0-9,.

CLOSE 

а	б	в	г	д	АБВ
е	ё	ж	з	и	ЧШЩ
й	к	л	м	н	абв
о	п	р	с	т	чшщ
у	ф	х	ц	—	0-9,.

CLOSE 

Ч	Ш	Щ	Ь	Ы	АБВ
Ь	Э	Ю	Я	Г	ЧШЩ
Є	І	Ї	Ў	Ѓ	абв
ћ	Ј	ЈЬ	Њ	Џ	чшщ
Ѓ	Ѕ	Ї	—		0-9,.

CLOSE 

0	1	2	3	4	АБВ
5	6	7	8	9	ЧШЩ
—	.	,	&	?	абв
!	(	)	/	'	чшщ
—					0-9,.

CLOSE 

あア年組  
 0~9&?!

\* Hiragana characters: One of the character sets of Japanese.  
 Hiragana-Zeichen: Einer der Zeichensätze für Japanisch.  
 Caractères Hiragana : l'un des jeux de caractères japonais.  
 Hiragana-tekens: een van de tekensets van Japans.  
 Caratteri Hiragana: uno dei set di caratteri della lingua giapponese.  
 Caracteres Hiragana: uno de los grupos de caracteres del japonés.  
 Хирагана: один из наборов символов (азбука) в японском языке.

Katakana characters: One of the character sets of Japanese.  
 Katakana-Zeichen: Einer der Zeichensätze für Japanisch.  
 Caractères Katakana : l'un des jeux de caractères japonais.  
 Catalaan-tekens: een van de tekensets van Japans.  
 Caratteri Katakana: uno dei set di caratteri della lingua giapponese.  
 Caracteres Katakana: uno de los grupos de caracteres del japonés.  
 Катакана: один из наборов символов (азбука) в японском языке.



Arabic numerals, Japanese Kanji numerals  
 Arabische Ziffern, japanische Kanji-Ziffern  
 Chiffres arabes, chiffres Kanji japonais  
 Arabische cijfers, Japanse Kanji-cijfers  
 Numeri arabi, numeri Kanji giapponesi  
 Números arábigos, números Kanji japoneses  
 Арабские цифры и иероглифы кандзи

Kanji characters often used in daily life / symbols.  
 Im Alltag häufig verwendete Kanji-Zeichen / Symbole.  
 Les caractères Kanji sont souvent utilisés dans la vie de tous les jours / symboles.  
 Kanji-tekens worden vaak gebruikt in het dagelijks leven / symbolen.  
 Caratteri Kanji spesso utilizzati nella vita quotidiana / simboli.  
 Los caracteres Kanji se utilizan a menudo en la vida diaria / como símbolos.  
 Иероглифы кандзи часто используются в повседневной жизни или как символы.

Horizontal  
 Horizontal  
 Horizontal  
 Horizontal  
 Horizontaal  
 Orizzontale  
 Horizontal  
 По горизонтали

Vertical  
 Vertikal  
 Vertical  
 Verticaal  
 Verticale  
 Vertical  
 По вертикали

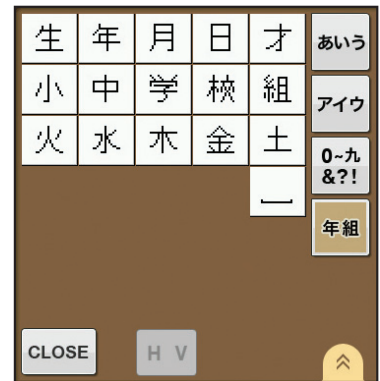
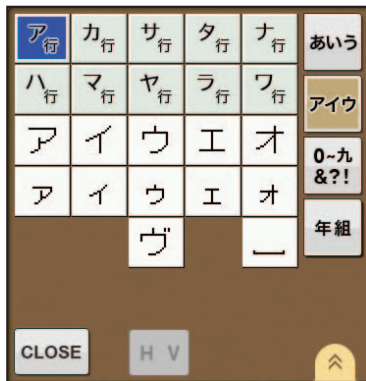

\* Japanese characters  
 \* Japanse tekens  
 \* Японские иероглифы

\* Japanische Zeichen  
 \* Caratteri giapponesi

\* Caractères japonais  
 \* Caracteres japoneses

English  
 German  
 French  
 Dutch  
 Italian  
 Spanish  
 Russian

882-D00



XF3634-101①