

Solaris™

Instruction & Reference Guide Sewing

Model BLSA



baby lock

FOR THE LOVE OF SEWING

To register your machine warranty and receive Baby Lock product updates and offers, go to babylock.com/login. If you have questions about registration, visit your Authorized Baby Lock Retailer.

Baby Lock Consumer Helpline: 800-313-4110

www.BabyLock.com

INTRODUCTION

Thank you for purchasing this machine.

Before using this machine or attempting any maintenance, carefully read the “IMPORTANT SAFETY INSTRUCTIONS” on this page, and then study the Instruction and Reference Guide for the correct operation of the various functions. In addition, after you have finished reading this product safety manual, store it where it can quickly be accessed for future reference. Failure to follow these instructions may result in an increased risk of personal injury or damage to property, including through fire, electrical shock, burns or suffocation.

IMPORTANT SAFETY INSTRUCTIONS

Please read these safety instructions before attempting to use the machine.

⚠ DANGER - To reduce the risk of electric shock

1 Always unplug the machine from the electrical outlet immediately after using, when cleaning, when making any user servicing adjustments mentioned in this manual, or if you are leaving the machine unattended.

⚠ WARNING - To reduce the risk of burns, fire, electric shock, or injury to persons.

2 Always unplug the machine from the electrical outlet when removing covers, or when making any adjustments mentioned in the instruction manual.

- To unplug the machine, switch the machine to the symbol “O” position to turn it off, then grasp the plug and pull it out of the electrical outlet. Do not pull on the cord.
- Plug the machine directly into the electrical outlet. Do not use an extension cord.
- Always unplug your machine if the power is cut.

3 Electrical Hazards:

- This machine should be connected to an AC power source within the range indicated on the rating label. Do not connect it to a DC power source or inverter. If you are not sure what kind of power source you have, contact a qualified electrician.
- This machine is approved for use in the country of purchase only.

4 Never operate this machine if it has a damaged cord or plug, if it is not working properly, if it has been dropped or damaged, or water is spilled on the unit. Return the machine to the nearest authorized Baby Lock retailer for examination, repair, electrical or mechanical adjustment.

- While the machine is stored or in use if you notice anything unusual, such as an odor, heat, discoloration or deformation, stop using the machine immediately and unplug the power cord.
- When transporting the sewing machine, be sure to carry it by its handle. Lifting the sewing machine by any other part may damage the machine or result in the machine falling, which could cause injuries.
- When lifting the sewing machine, be careful not to make any sudden or careless movements, otherwise you may injure your back or knees.

5 Always keep your work area clear:

- Never operate the machine with any air openings blocked. Keep ventilation openings of the sewing machine and foot control free from the build up of lint, dust, and loose cloth.
- Do not store objects on the foot controller.
- Do not use extension cords. Plug the machine directly into the electrical outlet.
- Never drop or insert any object into any opening.
- Do not operate where aerosol (spray) products are being used or where oxygen is being administered.
- Do not use the machine near a heat source, such as a stove or iron; otherwise, the machine, power cord or garment being sewn may ignite, resulting in fire or an electric shock.
- Do not place this sewing machine on an unstable surface, such as an unsteady or slanted table, otherwise the sewing machine may fall, resulting in injuries.

6 Special care is required when sewing:

- Always pay close attention to the needle. Do not use bent or damaged needles.
- Keep fingers away from all moving parts. Special care is required around the machine needle.
- Switch the sewing machine to the symbol "O" position to turn it off when making any adjustments in the needle area.
- Do not use a damaged or incorrect needle plate, as it could cause the needle to break.
- Do not push or pull the fabric when sewing, and follow careful instruction when free motion stitching so that you do not deflect the needle and cause it to break.

7 This machine is not a toy:

- Your close attention is necessary when the machine is used by or near children.
- The plastic bag that this sewing machine was supplied in should be kept out of the reach of children or disposed of. Never allow children to play with the bag due to the danger of suffocation.
- Do not use outdoors.

8 For a longer service life:

- When storing this machine, avoid direct sunlight and high humidity locations. Do not use or store the machine near a space heater, iron, halogen lamp, or other hot objects.
- Use only neutral soaps or detergents to clean the case. Benzene, thinner, and scouring powders can damage the case and machine, and should never be used.
- Always consult the Instruction and Reference Guide when replacing or installing any assemblies, the presser feet, needle, or other parts to assure correct installation.

9 For repair or adjustment:

- If the light unit is damaged, it must be replaced by an authorized Baby Lock retailer.
- In the event a malfunction occurs or adjustment is required, first follow the troubleshooting table in the back of the Instruction and Reference Guide to inspect and adjust the machine yourself. If the problem persists, please consult your local authorized Baby Lock retailer.

Use this machine only for its intended use as described in the manual.

Use accessories recommended by the manufacturer as contained in this manual.

Use only the mouse designed specifically for this machine.

The contents of this manual and specifications of this product are subject to change without notice.

For additional product information and updates, visit our website at www.babylock.com

SAVE THESE INSTRUCTIONS

This machine is intended for household use.

FOR USERS IN COUNTRIES EXCEPT EUROPEAN COUNTRIES

This appliance is not intended for use by persons (including children) with reduced physical, sensory or mental capabilities, or lack of experience and knowledge, unless they have been given supervision or instruction concerning use of the appliance by a person responsible for their safety. Children should be supervised to ensure that they do not play with the appliance.

FOR USERS IN EUROPEAN COUNTRIES

This appliance can be used by children aged from 8 years and above and persons with reduced physical, sensory or mental capabilities or lack of experience and knowledge if they have been given supervision or instruction concerning use of the appliance in a safe way and understand the hazards involved. Children shall not play with the appliance. Cleaning and user maintenance shall not be made by children without supervision.

FOR USERS IN THE UK, EIRE, MALTA AND CYPRUS ONLY

IMPORTANT

- In the event of replacing the plug fuse, use a fuse approved by ASTA to BS 1362, i.e. carrying the  mark, rating as marked on plug.
- Always replace the fuse cover. Never use plugs with the fuse cover omitted.
- If the available electrical outlet is not suitable for the plug supplied with this equipment, you should contact your authorized Baby Lock retailer to obtain the correct lead.

Federal Communications Commission (FCC) Declaration of Conformity (For U.S.A. Only)

Responsible Party: Tacony Corporation
1760 Gilsinn Lane, Fenton, Missouri 63026 USA

declares that the product

Product Name: Baby Lock Sewing Machine
Model Number: BLSA

This device complies with Part 15 of the FCC Rules. Operation is subject to the following two conditions: (1) this device may not cause harmful interference, and (2) this device must accept any interference received, including interference that may cause undesired operation.

This equipment has been tested and found to comply with the limits for a Class B digital device, pursuant to Part 15 of the FCC Rules. These limits are designed to provide reasonable protection against harmful interference in a residential installation. This equipment generates, uses, and can radiate radio frequency energy and, if not installed and used in accordance with the instructions, may cause harmful interference to radio communications. However, there is no guarantee that interference will not occur in a particular installation. If this equipment does cause harmful interference to radio or television reception, which can be determined by turning the equipment off and on, the user is encouraged to try to correct the interference by one or more of the following measures:

- Reorient or relocate the receiving antenna.
- Increase the separation between the equipment and receiver.
- Connect the equipment into an outlet on a circuit different from that to which the receiver is connected.
- Consult the authorized Baby Lock retailer or an experienced radio/TV technician for help.
- This transmitter must not be co-located or operated in conjunction with any other antenna or transmitter.

Important

Changes or modifications not expressly approved by Tacony Corporation could void the user's authority to operate the equipment.

This equipment complies with FCC/IC radiation exposure limits set forth for an uncontrolled environment and meets the FCC radio frequency (RF) Exposure Guidelines and RSS-102 of the IC radio frequency (RF) Exposure rules. This equipment has very low levels of RF energy that it deemed to comply without maximum permissive exposure evaluation (MPE).

For users in Canada

This equipment complies with FCC/IC radiation exposure limits set forth for an uncontrolled environment and meets the FCC radio frequency (RF) Exposure Guidelines and RSS-102 of the IC radio frequency (RF) Exposure rules. This equipment has very low levels of RF energy that it deemed to comply without maximum permissive exposure evaluation (MPE).

For users in Mexico

The operation of this equipment is subject to the following two conditions:

- (1) it is possible that this equipment or device may not cause harmful interference, and
- (2) this equipment or device must accept any interference, including interference that may cause undesired operation.

La operación de este equipo está sujeta a las siguientes dos condiciones:

- (1) es posible que este equipo o dispositivo no cause interferencia perjudicial y
- (2) este equipo o dispositivo debe aceptar cualquier interferencia, incluyendo la que pueda causar su operación no deseada.

Trademarks

IMPORTANT:

READ BEFORE DOWNLOADING, COPYING, INSTALLING OR USING.

By downloading, copying, installing or using the software you agree to this license. If you do not agree to this license, do not download, install, copy or use the software.

Intel License Agreement For Open Source Computer Vision Library

Copyright © 2000, Intel Corporation, all rights reserved. Third party copyrights are property of their respective owners.

Redistribution and use in source and binary forms, with or without modification, are permitted provided that the following conditions are met:

- Redistribution's of source code must retain the above copyright notice, this list of conditions and the following disclaimer.
- Redistribution's in binary form must reproduce the above copyright notice, this list of conditions and the following disclaimer in the documentation and/or other materials provided with the distribution.
- The name of Intel Corporation may not be used to endorse or promote products derived from this software without specific prior written permission.

This software is provided by the copyright holders and contributors "as is" and any express or implied warranties, including, but not limited to, the implied warranties of merchantability and fitness for a particular purpose are disclaimed. In no event shall Intel or contributors be liable for any direct, indirect, incidental, special, exemplary, or consequential damages (including, but not limited to, procurement of substitute goods or services; loss of use, data, or profits; or business interruption) however caused and on any theory of liability, whether in contract, strict liability, or tort (including negligence or otherwise) arising in any way out of the use of this software, even if advised of the possibility of such damage.

All information provided related to future Intel products and plans is preliminary and subject to change at any time, without notice.

FlashFX[®] is a registered trademark of Datalight, Inc.

FlashFX[®] Copyright 1998-2007 Datalight, Inc.

U.S.Patent Office 5,860,082/6,260,156

FlashFX[®] Pro[™] is a trademark of Datalight, Inc.

Datalight[®] is a registered trademark of Datalight, Inc.

Copyright 1989-2007 Datalight, Inc., All Rights Reserved

Secure Digital (SD) Card is a registered trademark or a trademark of SD-3C, LLC.

CompactFlash is a registered trademark or a trademark of Sandisk Corporation.

Memory Stick is a registered trademark or a trademark of Sony Corporation.

SmartMedia is a registered trademark or a trademark of Toshiba Corporation.

MultiMediaCard (MMC) is a registered trademark or a trademark of Infineon Technologies AG.

xD-Picture Card is a registered trademark or a trademark of Fuji Photo Film Co. Ltd.

IBM is a registered trademark or a trademark of International Business Machines Corporation.

Microsoft, Windows and Windows Vista are registered trademarks or trademarks of Microsoft Corporation.

"Adobe" and "Adobe Reader" are either registered trademarks or trademarks of Adobe Systems Incorporated in the United States and/or other countries.

This software is based in part on the work of the Independent JPEG Group.

Each company whose software title is mentioned in this manual has a Software License Agreement specific to its proprietary programs.

All other brands and product names mentioned in this manual are registered trademarks of their respective companies. However, the explanations for markings such as [®] and [™] are not clearly described within the text.

HOW TO USE THIS MANUAL

The Instruction and Reference Guides for this machine consist of the Instruction and Reference Guide (Sewing) and the Instruction and Reference Guide (Embroidery). Refer to the appropriate Instruction and Reference Guide according to your needs. For basic information about, for example, the included accessories or the settings screen, refer to chapter 1 of the Instruction and Reference Guide (Sewing). In the screens appearing in the step-by-step instructions, the parts referred to in the operations are marked with . Compare the screen in the directions with the actual screen, and carry out the operation. If, while using the machine, you experience something you do not understand, or there is a function you would like to know more about, refer to the index at the back of the Instruction and Reference Guide in conjunction with the table of contents to find the section of the manual you should refer to.

CONTENTS

INTRODUCTION	1	Automatic Presser Foot Lowering Function and Thread Cutting Function	81
IMPORTANT SAFETY INSTRUCTIONS	1	Sewing Curves	81
Trademarks	6	Changing Sewing Direction	81
HOW TO USE THIS MANUAL	7	Sewing Heavyweight Fabrics	82
Chapter 1 Getting Ready	11	Sewing Hook-and-Loop Fastener Tape.....	83
NAMES OF MACHINE PARTS AND THEIR FUNCTIONS	12	Sewing Lightweight Fabrics.....	84
Machine	12	Sewing Stretch Fabrics	84
Needle and Presser Foot Section	14	STITCH SETTINGS	85
Embroidery Unit.....	15	Setting the Stitch Width	85
Operation Buttons	15	Setting the Stitch Length.....	86
Using the Flat Bed Attachment	16	Setting the "L/R Shift"	86
Using the Accessory Case.....	16	Setting the Thread Tension.....	87
Included Accessories.....	17	USEFUL FUNCTIONS	88
Options	20	Automatic Thread Cutting.....	88
Using the Multi-purpose Screwdriver	23	Pivoting	89
Using the Spool Stand	23	Using the Knee Lifter	90
Assembling the Spool Stand	24	Automatic Fabric Sensor System (Automatic Presser Foot Pressure)	91
TURNING THE MACHINE ON/OFF	25	Needle Position - Stitch Placement	92
Setting Your Machine for the First Time	26	Checking the Needle Location in the Screen.....	92
LCD SCREEN	27	USING THE PROJECTOR	94
Using the Machine Setting Mode Key.....	28	Convenient Sewing Features by Using the Projector	94
Sewing Settings	28	About the Dual Purpose Stylus.....	94
General Settings	29	Installing a Battery in the Dual Purpose Stylus	94
Embroidery Settings.....	31	Operating the Projector with the Dual Purpose Stylus	95
Wireless LAN settings.....	32	Using the Dual Purpose Stylus Holder	95
Setting Functions	32	PROJECTOR FUNCTIONS (UTILITY STITCHES AND CHARACTER/DECORATIVE STITCHES)	96
Using the Machine Help Key.....	38	Projection Area of Projector.....	96
Using the Operation Guide Function.....	39	Projecting the Stitch Pattern with the Projector	96
Using the Sewing Guide Function	40	Selecting a Stitch Pattern with the Dual Purpose Stylus	97
Playing a Tutorial Video	41	Editing a Stitch Pattern Selected with the Dual Purpose Stylus ...	97
Playing MPEG-4 (MP4) Videos	42	Projecting the Guidelines with the Projector	98
Using the Stitch Pattern Explanation Function	43	Chapter 3 Utility Stitches	101
Viewing the Instruction and Reference Guide (PDF File) on the Machine.....	44	SELECTING UTILITY STITCHES	102
WIRELESS NETWORK CONNECTION FUNCTIONS	45	Selecting a Stitch	105
Specifying Wireless Network Connection Settings	45	Saving Your Stitch Settings.....	107
Using the Wizard to Set Up the Wireless Network Connection ...	46	SEWING THE STITCHES	108
CONNECTING THE ACCESSORY TO THE MACHINE	48	Straight Stitches	108
Using USB Media/SD card (Sold Separately).....	48	Dart Seam.....	112
Using a USB Mouse (Sold Separately).....	48	Gathering	113
Chapter 2 Sewing Basics	51	Flat Fell Seam	113
LOWER THREADING	52	Pintuck	114
Winding the Bobbin	52	Zigzag Stitches.....	116
Setting the Bobbin	58	Elastic Zigzag Stitches.....	117
Pulling Up the Bobbin Thread	59	Overcasting	118
UPPER THREADING	61	Quilting.....	121
Upper Threading.....	61	Blind Hem Stitches	131
Using the Twin Needle Mode.....	64	Appliqué.....	133
Using the Spool Stand	66	Shelltuck Stitches.....	134
Using Threads that Unwind Quickly	68	Scallop Stitches.....	135
CHANGING THE NEEDLE	69	Crazy Quilting	135
Fabric/Thread/Needle Combinations	71	Smocking Stitches.....	136
CHANGING THE PRESSER FOOT	72	Fagoting.....	137
Removing the Presser Foot	72	Tape or Elastic Attaching	137
Attaching the Presser Foot	72	Heirloom	138
Attaching the Presser Foot with the Included Adapter.....	73	Basting.....	140
Using the Dual Feed Foot.....	74	One-step Buttonholes	141
SEWING	77	Four-step Buttonholes	145
Sewing a Stitch.....	77	Bar Tacks	148
Sewing Reinforcement Stitches.....	79	Button Sewing	149
Automatic Reinforcement Stitching	79	Eyelet.....	150
		Multi-directional Sewing (Straight Stitch and Zigzag Stitch) ...	151
		Zipper Insertion	152

Chapter 4 Character/Decorative Stitches 157

SELECTING STITCH PATTERNS	158
Selecting Decorative Stitch Patterns	160
Selecting Character Stitch Patterns	160
SEWING STITCH PATTERNS.....	163
Sewing Attractive Finishes.....	163
Basic Sewing.....	163
Making Adjustments	164
EDITING STITCH PATTERNS	166
Changing the Size	169
Changing the Length (for 7mm Satin Stitch Patterns Only)...	169
Creating a Vertical Mirror Image	169
Creating a Horizontal Mirror Image	169
Sewing a Stitch Pattern Continuously	169
Changing Thread Density (for Large Satin Only).....	170
Returning to the Beginning of the Stitch Pattern	170
Checking the Image	171
COMBINING STITCH PATTERNS	172
Before Combining	172
Combining Various Stitch Patterns	172
Combining Large and Small Stitch Patterns	173
Combining Horizontal Mirror Image Stitch Patterns	174
Combining Stitch Patterns of Different Length	175
Making Step Stitch Patterns	175
USING THE MEMORY FUNCTION.....	178
Stitch Data Precautions	178
Saving Stitch Patterns in the Machine's Memory	179
Saving Stitch Patterns to USB Media	179
Retrieving Stitch Patterns from the Machine's Memory.....	180
Recalling from USB Media.....	181
Managing Saved File.....	182

Chapter 5 Appendix 183

CARE AND MAINTENANCE.....	184
Restrictions on oiling	184
Precautions on storing the machine	184
Cleaning the LCD Screen	184
Cleaning the Machine Casing	184
Cleaning the Race.....	184
Cleaning the Bobbin Case	186
Cleaning the Cutter in the Bobbin Case Area	186
About the Maintenance Message	187
TROUBLESHOOTING.....	188
Frequent Troubleshooting Topics	188
Upper Thread is Too Tight	188
Tangled Thread on Wrong Side of Fabric	189
Incorrect Thread Tension	191
Fabric is Caught in the Machine and Cannot be Removed ...	192
List of Symptoms.....	195
ERROR MESSAGES	200
SPECIFICATIONS	203
UPGRADING YOUR MACHINE'S SOFTWARE ...	204
Upgrade Procedure Using USB Media	204
STITCH SETTING CHART.....	206
INDEX	215

1

2

3

4

5



Chapter *1*
Getting Ready



NAMES OF MACHINE PARTS AND THEIR FUNCTIONS

The names of the various parts of the machine and their functions are described below. Before using the machine, carefully read these descriptions to learn the names of the machine parts.

Machine

■ Front View

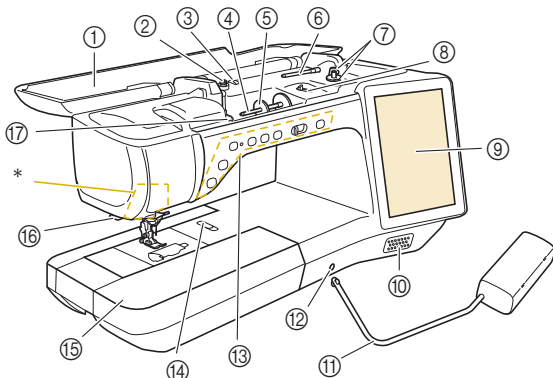

- ① **Top cover**
Open the top cover when threading the machine or winding the bobbin.

⚠ CAUTION

- Do not place any object weighing 1 kg or more on the top cover, otherwise the cover may be damaged.

- ② **Pretension disk**
Pass the thread around the pretension disk when winding the bobbin thread. (page 52)
- ③ **Thread guide for bobbin winding**
Pass the thread through this thread guide when winding the bobbin thread. (page 52)
- ④ **Spool pin**
Place a spool of thread on the spool pin. (page 61)
- ⑤ **Spool cap**
Use the spool cap to hold the spool of thread in place. (page 61)
- ⑥ **Supplemental spool pin**
Use this spool pin to wind the bobbin thread, or to sew with the twin needle. (page 52, 64)
- ⑦ **Bobbin winder**
Use the bobbin winder when winding the bobbin. (page 52)
- ⑧ **Bobbin winding slider**
Adjust the amount of thread wound onto the bobbin. (page 54)
- ⑨ **LCD (liquid crystal display)**
Settings for the selected stitch and error messages appear in the LCD. (page 27)
- ⑩ **Speaker**
- ⑪ **Knee lifter**
Use the knee lifter to raise and lower the presser foot. (page 90)
- ⑫ **Knee lifter slot**
Insert the knee lifter into the slot. (page 90)
- ⑬ **Operation buttons (7 buttons) and sewing speed controller**
Use these buttons and the slide to operate the machine. (page 15)
- ⑭ **Needle plate lever**
Slide the lever toward you to remove the needle plate. (page 184)

- ⑮ **Flat bed attachment with accessory compartment**
Store presser feet and bobbins in the accessory compartment of the flat bed attachment. When sewing cylindrical pieces, remove the flat bed attachment. (page 16)
- ⑯ **Thread cutter**
Pass the threads through the thread cutter to cut them. (page 63)
- ⑰ **Thread guide plate**
Pass the thread around the thread guide plate when threading upper thread. (page 61)
- * Camera and projector (built-in)

⚠ CAUTION

- Do not touch the camera or projector. Otherwise, it will not display properly.

■ Right-side/Rear View

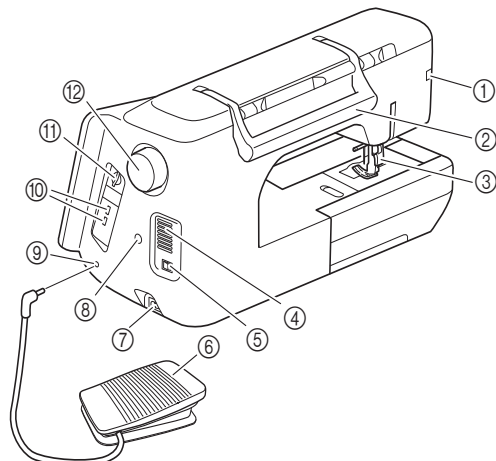

- ① **Connector for the presser foot**
Connect the dual feed foot or embroidery foot with LED pointer (sold separately). (page 74)
- ② **Handle**
Carry the machine by its handle when transporting the machine.
- ③ **Presser foot lever**
Raise and lower the presser foot lever to raise and lower the presser foot. (page 72)
- ④ **Air vent**
The air vent allows the air surrounding the motor to circulate. Do not cover the air vent while the machine is being used.
- ⑤ **Main power switch**
Use the main power switch to turn the machine ON and OFF. (page 25)
- ⑥ **Foot controller**
Use the foot controller to operate the machine.
- ⑦ **Power cord receptacle**
Insert the power cord into the machine receptacle. (page 25)
- ⑧ **Dual purpose stylus holder connector**
Connect the included dual purpose stylus holder. (page 95)
- ⑨ **Foot controller jack**
Insert the foot controller plug into its jack on the machine. (page 78)

⑩ USB port

In order to send stitch patterns and embroidery patterns from/to USB media, plug the USB media directly into the USB port.

⑪ SD card slot

Insert an SD card into the SD card slot in order to import/export stitch patterns and embroidery patterns.

⑫ Handwheel

Rotate the handwheel toward you (counterclockwise) to raise and lower the needle. The wheel should be turned toward the front of the machine.



Needle and Presser Foot Section

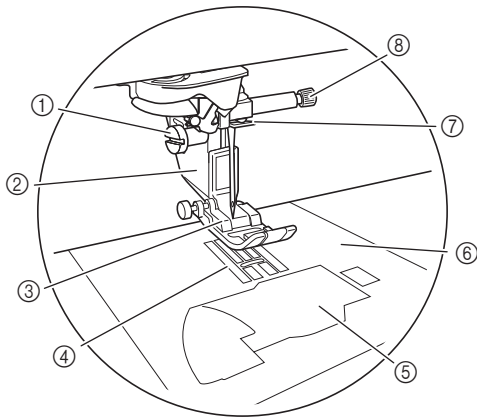

- ① **Presser foot holder screw**
Use the presser foot holder screw to hold the presser foot in place. (page 73)
- ② **Presser foot holder**
The presser foot is attached to the presser foot holder. (page 72)
- ③ **Presser foot**
The presser foot consistently applies pressure to the fabric as sewing takes place. Attach the appropriate presser foot for the selected stitch. (page 72)
- ④ **Feed dogs**
The feed dogs feed the fabric in the sewing direction.
- ⑤ **Bobbin cover**
Open the bobbin cover to set the bobbin. (page 58, 117)
- ⑥ **Needle plate**
The needle plate is marked with guides to help sew straight seams. (page 110)
Remove the needle plate to clean the race. (page 111, 184)
- ⑦ **Needle bar thread guide**
Pass the upper thread through the needle bar thread guide. (page 61)
- ⑧ **Needle clamp screw**
Use the needle clamp screw to hold the needle in place. (page 73)

Measurements on the needle plate and the bobbin cover (with mark)

The measurements on the bobbin cover and needle plate are references for stitch patterns with a left or middle (center) needle position.

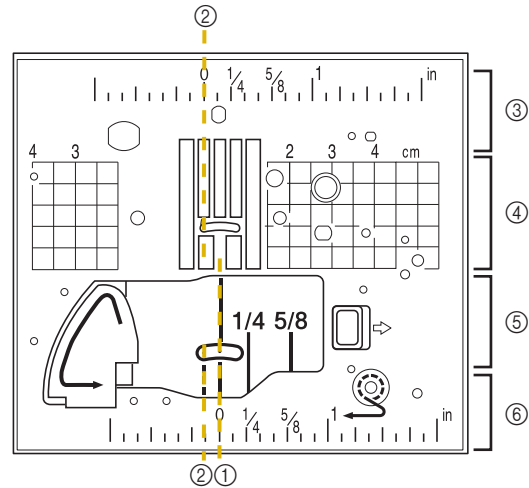

- ① **For stitches with a middle (center) needle position**
- ② **For stitches with a left needle position**
- ③ **Left needle position on the needle plate <inch>**
- ④ **Left needle position on the needle plate <cm>**
- ⑤ **Middle (center) needle position on the bobbin cover (with mark) <inch>**
- ⑥ **Middle (center) needle position on the needle plate <inch>**

Embroidery Unit

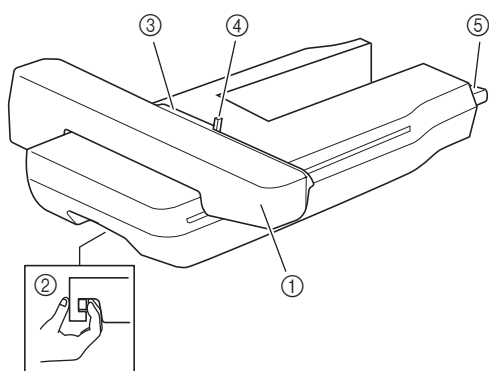

- ① **Carriage**
The carriage moves the embroidery frame automatically when embroidering.
- ② **Release lever (located under the embroidery unit)**
Press the release lever to remove the embroidery unit.
- ③ **Embroidery frame holder**
Insert the embroidery frame into the embroidery frame holder to hold the frame in place.
- ④ **Frame-securing lever**
Press the frame-securing lever down to secure the embroidery frame.
- ⑤ **Embroidery unit connection**
Insert the embroidery unit connection into the connection port when attaching the embroidery unit.



⚠ CAUTION

- Before inserting or removing the embroidery unit, turn the main power to off.
- After the embroidery frame is set in the frame holder, be sure the frame-securing lever is correctly lowered.

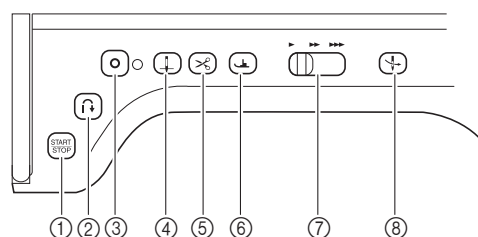
Operation Buttons



- ① **“Start/Stop” button** 
Press this button and the machine will sew a few stitches at a slow speed and then begin sewing at the speed set by the sewing speed controller. Press the button again to stop the machine. Hold the button in to sew at the machine’s slowest speed. The button changes color according to the machine’s operation mode.

Green: The machine is ready to sew or is sewing.
Red: The machine cannot sew.
- ② **“Reverse Stitch” button** 
For straight, zigzag, and elastic zigzag stitch patterns that take reverse stitches, the machine will sew reverse stitches at low speed only while holding down the “Reverse Stitch” button. The stitches are sewn in the opposite position. For other stitches, use this button to sew reinforcement stitches at the beginning and end of sewing. Press and hold this button, and the machine sews 3 stitches in the same spot and stops automatically. (page 79)
- ③ **“Reinforcement Stitch” button** 
Use this button to sew a single stitch repeatedly and tie-off. For character/decorative stitches, press this button to end with a full stitch instead of at a mid-point. The LED light beside this button lights up while the machine is sewing a full motif, and automatically turns off when the sewing is stopped. (page 79)
- ④ **“Needle Position” button** 
Use this button when changing sewing direction or for detailed sewing in small areas. Press this button to raise or lower the needle position. With this button, you can lower and raise the needle to sew a single stitch.
- ⑤ **“Thread Cutter” button** 
Press this button after sewing to automatically trim the excess thread.
- ⑥ **“Presser Foot Lifter” button** 
Press this button to lower the presser foot and apply pressure to the fabric. Press this button again to raise the presser foot.
- ⑦ **Sewing Speed controller** 
Use this controller to adjust the sewing speed. Move the slide to the left to sew at slower speeds. Move the slide to the right to sew at higher speeds.
- ⑧ **“Automatic Threading” button** 
Use this button to automatically thread the needle.

⚠ CAUTION

- Do not press the thread cutter button after the threads have been cut. The needle may break and threads may become tangled, or damage to the machine may occur.

Using the Flat Bed Attachment

Pull the top of the flat bed attachment to open the accessory compartment.

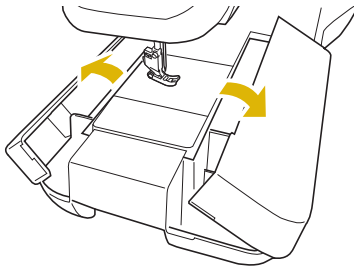

Using the Accessory Case

Opening the Accessory Case

Slide the latches on the front of the accessory case outward to open it.

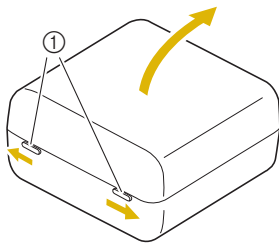

① Latches

Using the Accessory Trays

Three presser foot storage trays are stored in the included accessory case.

For your convenience, a presser foot storage tray can be stored in the accessory compartment of the flat bed attachment.

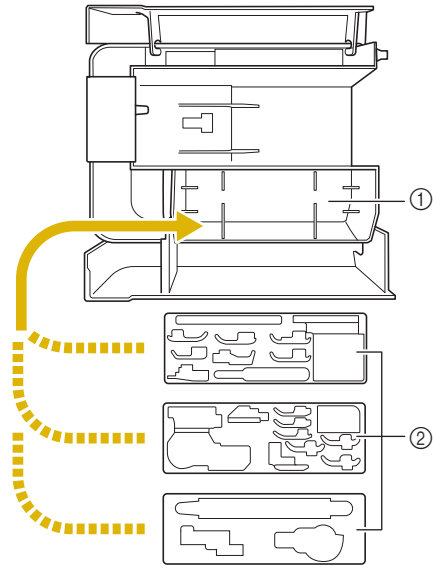







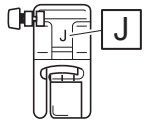
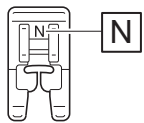
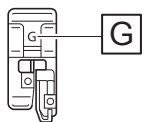
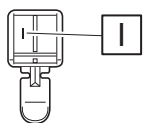
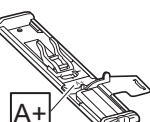
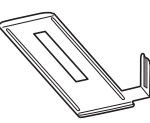
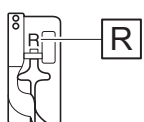
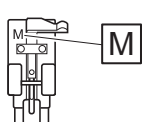
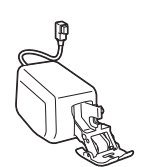

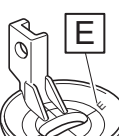
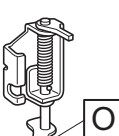
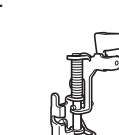
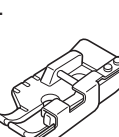
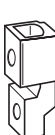

- ① Presser foot storage space of the flat bed attachment
- ② Presser foot storage trays



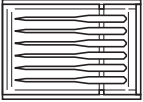
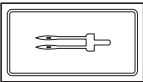

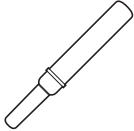



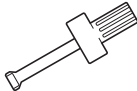

Included Accessories

After opening the box, check that the following accessories are included. If any item is missing or damaged, contact your authorized Baby Lock retailer.

	Part Name
	Part Code
1. 	Zigzag foot "J" (on machine)
	XF3022-001
2. 	Monogramming foot "N"
	X53840-351
3. 	Overcasting foot "G"
	XC3098-051
4. 	Zipper foot "I"
	X59370-051
5. 	Buttonhole foot "A+"
	XH2665-001
6. 	Buttonhole foot stabilizer
	XH1726-001
7. 	Blind stitch foot "R"
	X56409-051
8. 	Button fitting foot "M"
	130489-001
9. 	Dual feed foot
	XF4068-201



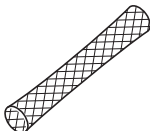

	Part Name
	Part Code
10. 	Regular dual feed foot
	XF4419-001
11. 	Straight stitch foot
	XD0826-051
12. 	Free motion quilting foot "C"
	XF4737-001
13. 	Free motion echo quilting foot "E"
	XE0766-001
14. 	Free motion open toe quilting foot "O"
	XF4873-001
15. 	Embroidery foot "W"
	XF4012-001
16. 	1/4 quilting foot with guide
	XC6800-251
17. 	Adapter
	XF3613-001

	Part Name
	Part Code
18.	Screw (small)
	XA4813-051
19.	Needle set 75/11 2 needles 90/14 2 needles 90/14 2 needles: Ball point needle (gold colored)
	XE4962-001
20.	Twin needle 2.0/11 needle
	XE4963-001
21.	Ball point needle set 75/11 2 needles: Ball point needle for embroidery HAX130EBBR
	XD0705-151
22.	Bobbin x 10 (One is on machine.)
	X52800-150
23.	Seam ripper
	XF4967-001
24.	Scissors
	XF2052-001
25.	Cleaning brush
	X59476-051
26.	Eyelet punch
	XZ5051-001
27.	Screwdriver (small)
	X55468-051

	Part Name
	Part Code
28.	Screwdriver (large)
	XC4237-021
29.	Multi-purpose screwdriver
	BLMPD
30.	Spool cap (small)
	130013-154
31.	Spool cap (medium) x 2 (One is on machine.)
	X55260-153
32.	Spool cap (large)
	130012-054
33.	Thread spool insert (mini king spool insert)
	XA5752-121
34.	Spool stand
	XH1607-001 Refer to "Using the Spool Stand" on page 23.
35.	Spool felt (on machine)
	X57045-051
36.	Spool net x 2
	XA5523-050
37.	Embroidery needle plate cover
	XE4708-001

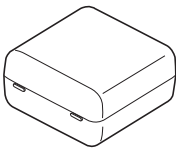
	Part Name	Part Code
38.	Knee lifter	XE4713-001
39.	Alternate bobbin case (no color on the screw)	XC8167-651
40.	Standard bobbin case (green marking on the screw) (on machine)	XE5342-101
41.	Straight stitch needle plate	XH2513-001
42.	Cord guide bobbin cover (with single hole)	XE0085-101
43.	Bobbin cover (with mark) (on machine)	XH3126-001
44.	Bobbin cover	XF9666-001
45.	Embroidery frame H 100 mm x W 100 mm (H 4 inches x W 4 inches)	EF74
46.	Embroidery frame H 180 mm x W 130 mm (H 7 inches x W 5 inches)	EF75
47.	Embroidery frame H 240 mm x W 240 mm (H 9-1/2 inches x W 9-1/2 inches)	XG5558-001

	Part Name	Part Code
48.	Embroidery frame H 408 mm x W 272 mm (H 16 inches x W 10-5/8 inches)	XH1466-001
49.	Scanning frame	XF9321-001
50.	Magnet x 6	XF9325-001
51.	Embroidery bobbin thread	BBT-W
52.	Embroidery positioning sticker sheets x 2	XE4912-501
53.	White calibration stickers (solid)	XE7916-001
54.	Stabilizer material	X81176-001
55.	Chalk pencil	XE8568-001
56.	Dual purpose stylus	XH2515-001
57.	Dual purpose stylus holder	XH1805-001

	Part Name
	Part Code
58.	Accessory case
	XH2514-001
59.	Foot controller
	XC8816-051
60.	Bobbin center pin and instruction sheet
	XF5048-001
61.	Power cord
	XC6052-151

Following documents can be downloaded.

- Instruction and Reference Guide (Sewing)
- Instruction and Reference Guide (Embroidery)
- Embroidery Design Guide



www.babylock.com/

 **Memo**





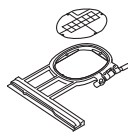
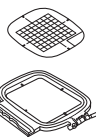
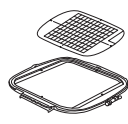

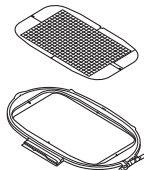
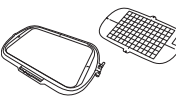
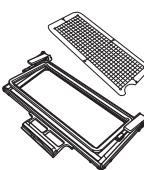
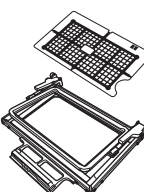
- (For U.S.A. only)
Foot controller: Model T
This foot controller can be used on the machine with product code 882-W31. The product code is mentioned on the machine rating plate.
- Always use accessories recommended for this machine.
- The screw for the presser foot holder is available through your authorized Baby Lock retailer (Part code XA4813-051).

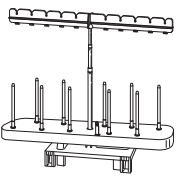
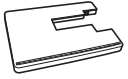
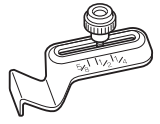
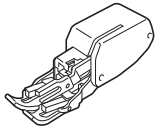
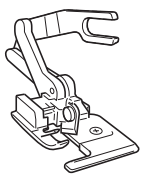
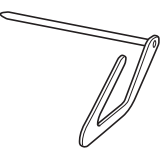
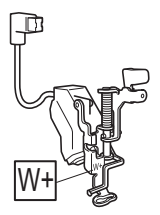

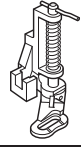
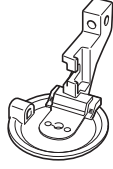
Options

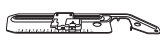
The following are available as optional accessories to be purchased separately from your authorized Baby Lock retailer.

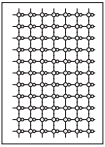
	Part Name
	Part Code
1.	Embroidery frame set H 20 mm × W 60 mm (H 1 inch × W 2-1/2 inches)
	EF73: Frame EF77: Embroidery sheet
2.	Embroidery frame set H 150 mm × W 150 mm (H 6 inches × W 6 inches)
	BLMA-150
3.	Embroidery frame set H 200 mm × W 200 mm (H 8 inches × W 8 inches)
	EF91: Frame EF93: Embroidery sheet
4.	Embroidery frame set H 300 mm × W 200 mm (H 12 inches × W 8 inches)
	EF92: Frame EF94: Embroidery sheet
5.	Embroidery frame set H 260 mm × W 160 mm (H 10-1/4 inches × W 6-1/4 inches)
	EF81: Frame EF84: Embroidery sheet
6.	Embroidery frame set H 360 mm × W 240 mm (H 14 inches × W 9-1/2 inches)
	EF95: Frame EF96: Embroidery sheet
7.	Border embroidery frame H 300 mm × W 100 mm (H 12 inches × W 4 inches)
	BLMA-CBH
8.	Border embroidery frame set H 180 mm × W 100 mm (H 7 inches × W 4 inches)
	BLSO-BF

	Part Name
	Part Code
9. 	Embroidery bobbin thread (white)
	BBT-W
	Embroidery bobbin thread (black)
	BBT-B
10. 	10 spool stand
	BLMA-TS
11. 	Wide table
	BLSA-ET
12. 	Seam guide
	BLG-SG
13. 	Walking foot
	BLG-WF
14. 	Side cutter foot
	BLG-SCF
15. 	Quilting guide
	BLG-QG
16. 	Embroidery foot "W+" with LED pointer
	BTY-EF

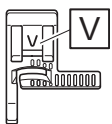
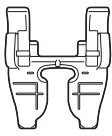
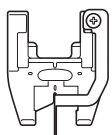
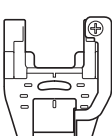
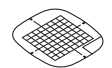
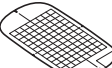
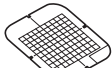
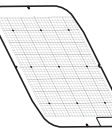
	Part Name
	Part Code
17. 	Free-motion quilting foot
	BLG-FM
18. 	Couching foot
	BLTY-CCF
19. 	Multi-Function Foot controller
	BLMA-MFC
20. 	Circular attachment
	BL-CSA
21. 	Edge joining foot
	ESG-EJF
22. 	Vertical spool pin
	XC8619-052
23. 	Embroidery positioning sticker sheets × 8
	BLSO-EPS
24. 	Free motion guide grip
	XG1921-001
25. 	USB mouse
	XE4904-101

	Part Name
	Part Code
26.	Vertical stitch alignment foot "V"
	BLSO-VF
27.	Open toe sole for dual feed foot
	BLTY-OTDF
28.	Stitch in the Ditch Sole for Digital Dual Foot
	BLDY-SDDF
29.	1/4" Sole with Guide for Digital Dual Foot
	BLDY-QDFD
30.	Embroidery frame sheet H 100 mm x W 100 mm (H 4 inches x W 4 inches)
	EF78
31.	Embroidery frame sheet H 180 mm x W 130 mm (H 7 inches x W 5 inches)
	EF79
32.	Embroidery frame sheet H 240 mm x W 240 mm (H 9-1/2 inches x W 9-1/2 inches)
	XG5566-001
33.	Embroidery frame sheet H 408 mm x W 272 mm (H 16 inches x W 10-5/8 inches)
	XH1825-001
34.	Bobbin Work Kit
	BL-BWA

 **Note**

- Visit your nearest authorized Baby Lock retailer for a complete listing of optional accessories for your machine.

 **Memo**

- All specifications are correct at the time of printing. Please be aware that some specifications may change without notice.

Using the Multi-purpose Screwdriver

Since the screwdriver can be changed to three different positions, it can be extremely useful for the various machine preparations. With this machine, position "1" and position "3" are used.

■ Position "1"

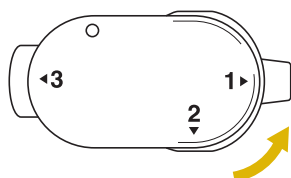

You can install/remove the presser foot holder, needle clamp screw.

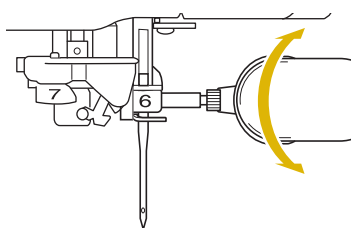
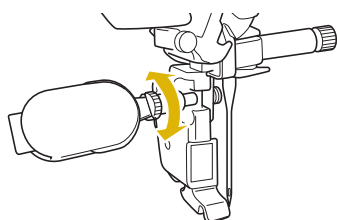

■ Position "3"

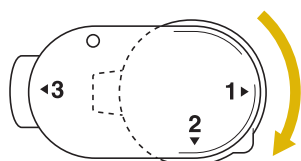

The multi-purpose screwdriver can be positioned over the screw on the embroidery frame to tighten the screw after hooping the fabric or when removing the fabric.

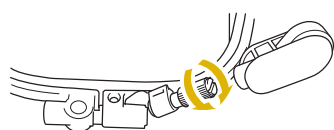

Note

- When rotating the multi-purpose screwdriver, do not forcefully rotate it in the direction that it does not rotate; otherwise, it may break.

Using the Spool Stand

The included spool stand is useful when using thread spools with a large diameter (cross-wound thread). The spool stand can hold two spools of thread.

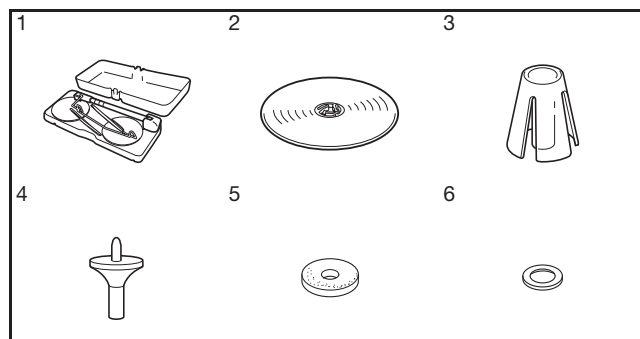

No.	Part Name	Part Code
1	Spool stand	XH1607-001
2	Spool cap (XL) × 2	XE0779-001
3	Spool holder × 2	XA0679-050
4	Spool cap base × 2	XE0780-001
5	Spool felt × 2	XC7134-051
6	Ring × 4	026030-136

* No.2 to No.6 are included in a plastic bag.

⚠ CAUTION

- Do not lift the handle of the machine while the spool stand is installed.
- Do not push or pull the telescopic thread guide or spool pins with extreme force, otherwise damage may result.
- Do not place any object other than spools of thread on the spool support.
- Do not try to wind thread on the bobbin while sewing using the spool stand.

■ Warning label

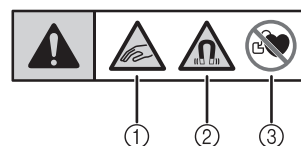

This product contains magnets.

- ① Be careful not to pinch your fingers or any objects between the spool stand and the upper cover of the machine.
- ② Be sure to keep the magnets away from precision electronics, computer disks, credit cards with a magnetic stripe, etc.
- ③ Do not use the spool stand if you have a pacemaker.

Assembling the Spool Stand

- 1** Hold in the tabs on the spool stand and remove the lid.

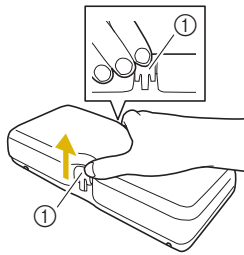

① Tabs

- 2** Raise the telescopic thread guide shaft and the two spool pins.

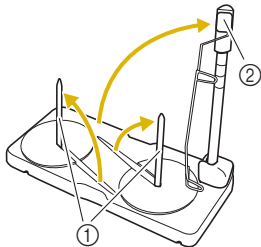

① Spool pins
② Telescopic thread guide shaft

- 3** Fully extend the telescopic thread guide shaft until the two internal stoppers snap into place.

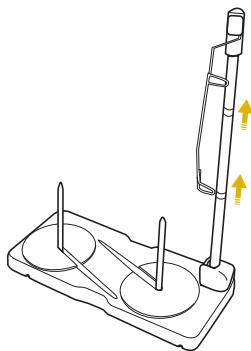

- 4** Turn the thread guide counterclockwise.

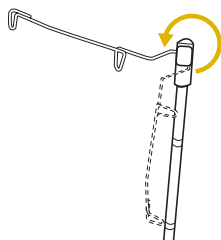

- 5** Open the upper cover of the machine, and then place the spool stand on the upper cover with the notches in the spool stand aligned with the tabs on the upper cover.

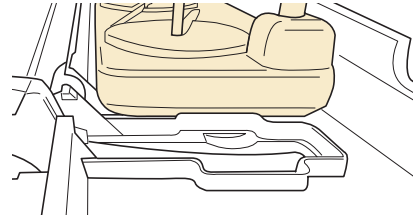

Note

- Make sure that the spool stand is firmly secured. Otherwise, the spool stand may fall during sewing.
- Do not place any object weighing 1 kg or more on the top cover. The weight of the spool stand with its lid removed is about 280 g.



Memo

- For details on winding the bobbin using the spool stand, refer to page 56.
- For details on upper threading using the spool stand, refer to page 66.

TURNING THE MACHINE ON/OFF

⚠ WARNING

- Use only regular household electricity for the power source. Using other power sources may result in fire, electric shock, or damage to the machine.
- Make sure that the plugs on the power cord are firmly inserted into the electrical outlet and the power cord receptacle on the machine. Otherwise, a fire or electric shock may result.
- Do not insert the plug on the power cord into an electrical outlet that is in poor condition.
- Turn the main power to OFF and remove the plug in the following circumstances:
 - When you are away from the machine
 - After using the machine
 - When the power fails during use
 - When the machine does not operate correctly due to a bad connection or a disconnection
 - During electrical storms

⚠ CAUTION

- Use only the power cord included with this machine.
- Do not use extension cords or multi-plug adapters with many other appliances plugged in to them. Fire or electric shock may result.
- Do not touch the plug with wet hands. Electric shock may result.
- When unplugging the machine, always turn the main power to OFF first. Always grasp the plug to remove it from the outlet. Pulling on the cord may damage the cord, or lead to fire or electric shock.
- Do not allow the power cord to be cut, damaged, modified, forcefully bent, pulled, twisted, or bundled. Do not place heavy objects on the cord. Do not subject the cord to heat. These things may damage the cord, or cause fire or electric shock. If the cord or plug is damaged, take the machine to your authorized Baby Lock retailer for repairs before continuing use.
- Unplug the power cord if the machine is not to be used for a long period of time. Otherwise, a fire may result.
- When leaving the machine unattended, either the main switch of the machine should be turned to OFF or the plug must be removed from the socket-outlet.
- When servicing the machine or when removing covers, the machine must be unplugged.
- For U.S.A only
 - This appliance has a polarized plug (one blade wider than the other). To reduce the risk of electrical shock, this plug is intended to fit in a polarized outlet only one way.
 - If the plug does not fit fully in the outlet, reverse the plug. If it still does not fit, contact a qualified electrician to install the proper outlet. Do not modify the plug in any way.

- 1 Insert the power supply cord into the power cord receptacle, then insert the plug into a wall outlet.

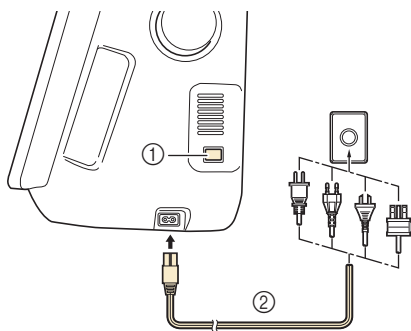

- ① Main power switch
- ② Power supply cord

- 2 Turn the main power switch to "I" to turn on the machine.

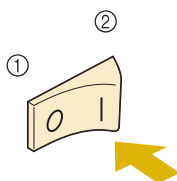

- ① OFF
- ② ON

Memo

- When the machine is turned on, the needle and the feed dogs will make sound when they move; this is not a malfunction.

- 3 Turn the main power switch to "O" to turn off the machine.

Memo

- If the machine is turned off in the middle of sewing in the "Sewing" function, the operation will not be continued after turning the power on again.

Setting Your Machine for the First Time

When you first turn on the machine, set the language and time/date to your language and local time/date. Follow the procedure below when the settings screen appears automatically.

- 1 Press **<** and **>** to set your local language.



- 2 Press **OK**.

- 3 The message screen, confirming if you want to set time/date, appears. To set the time/date, press **OK**; to cancel the setting, press **Cancel**.

→ The screen to set time/date appears.

- 4 Press **-** or **+** to set time date.

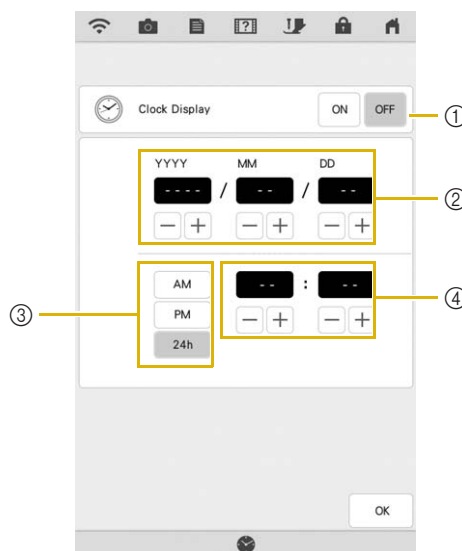

- ① Press to display the time on the screen.
- ② Set the year (YYYY), month (MM) and date (DD).
- ③ Select whether 24h or 12h setting to display.
- ④ Set the current time.

- 5 Press **OK** to start using your machine.

→ The clock starts from 0 second of the time you set.



Note

- The time/date you set may be cleared, if you don't turn on the machine for an extended period of time.
- Time setting is also available by pressing clock button/time on the LCD screen.

LCD SCREEN

When the machine is turned on, the opening movie is played. Touch anywhere on the screen for the home page screen to be displayed. Touch the LCD screen or a key with your finger or the included dual purpose stylus to select a machine function.



Note

- When the straight stitch needle plate is on the machine, the needle will automatically move to the middle position.



Memo

- Only touch the screen with your finger or the included dual purpose stylus. Do not use a sharp pencil, screwdriver, or other hard or sharp object. It is not necessary to press hard on the screen. Pressing too hard or using a sharp object may damage the screen.





■ Home Page Screen



No.	Display	Key Name	Explanation	Page
①		Sewing key	Press this key to sew utility stitches or character/ decorative stitch patterns.	102, 158
②		Embroidery key	Attach the embroidery unit and press this key to embroider patterns.	-
③		IQ Designer key	Press this key to start creating your custom design embroidery patterns.	-

No.	Display	Key Name	Explanation	Page
④		Wireless LAN key	Check the machine's signal strength. Press this key to specify the wireless settings.	45
⑤		Camera view key	Press this key to check the needle location as it is shown on the screen through the built-in camera.	92
⑥		Machine setting screen key	Press this key to change the needle stop position, adjust the stitch patterns and embroidery patterns or screen, and change other machine settings.	28
⑦		Machine help key	Press this key to see explanations on how to use the machine. You can see the tutorial videos and also the MP4 movie files that you have.	38
⑧		Presser foot/ Needle exchange key	Press this key before changing the needle, the presser foot, etc. This key locks all key and button functions to prevent operation of the machine.	58, 72
⑨		Screen lock key	Press this key to lock the screen. When the screen is locked, can still sew, but cannot change any of the screen functions. Press this key again to unlock the settings.	158
⑩		Home page screen key	Press this key anytime it is displayed to return to the home page screen and select a different category - "Sewing", "Embroidery" or "IQ Designer".	-
⑪		Time/Date key	Press this key to set the clock to your local time.	26

Using the Machine Setting Mode Key

Press  to change the default machine settings (needle stop position, embroidery speed, opening display, etc.). To display the different settings screens, press  for “Sewing settings”,  for “General settings”,  for “Embroidery settings” or  for “Wireless LAN settings”.

Memo

- Press  or  to display a different settings screen.

Sewing Settings

■ Page 1

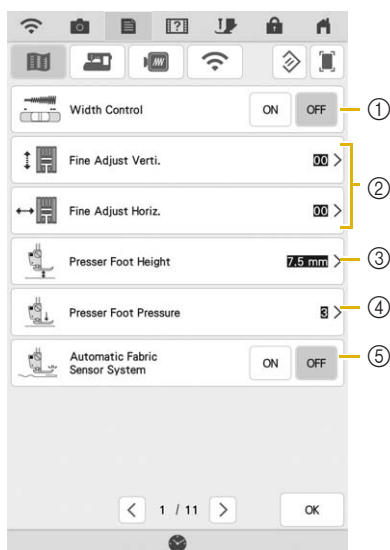

- ① Select whether to use the sewing speed controller to determine the zigzag width (page 125).
- ② Make adjustments to character or decorative stitch patterns (page 164).
- ③ Adjust the presser foot height. Select the height of the presser foot when the presser foot is raised.
- ④ Adjust the presser foot pressure. The higher the number, the greater the pressure will be. Set the pressure at “3” for normal sewing.
- ⑤ When set to “ON”, the thickness of the fabric is automatically detected by an internal sensor while sewing. This enables the fabric to be fed smoothly (pages 83 and 91).

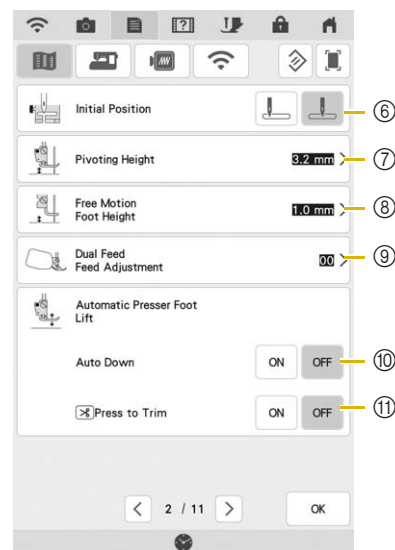

■ Page 2

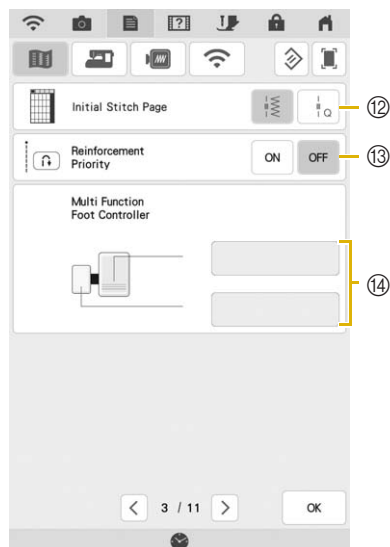

- ⑥ Select whether “1-01 Straight stitch (Left)” or “1-03 Straight stitch (Middle)” is the utility stitch that is automatically selected when the machine is turned on.
- ⑦ Change the height of the presser foot when sewing is stopped when the pivot setting is selected (page 89). Adjust the presser foot to one of the four heights.
- ⑧ Change the height of the presser foot when the machine is set to free motion sewing mode (page 126).
- ⑨ Adjust the amount of fabric feeding of the dual feed foot (page 76).
- ⑩ Pressing the “Start/Stop” button or depressing the foot controller automatically lowers the presser foot (if it is raised) before starting sewing.
- ⑪ Pressing the “Thread Cutter” button automatically lowers the presser foot before cutting the thread. The presser foot will be raised after the thread is cut.

Page 3



- ⑫ Select whether utility stitches () or quilting stitches () are displayed first in the stitch selection screen.
- ⑬ When set to “ON”, reinforcement stitches are sewn at the beginning and/or end of sewing for a reinforcement stitch pattern, even when the “Reverse Stitch” button is pressed (page 79).
- ⑭ You can activate this setting after connecting the multi-function foot controller (optional). (These settings are not operable unless the multi-function foot controller is attached to the machine.) (page 33)

General Settings

Page 4

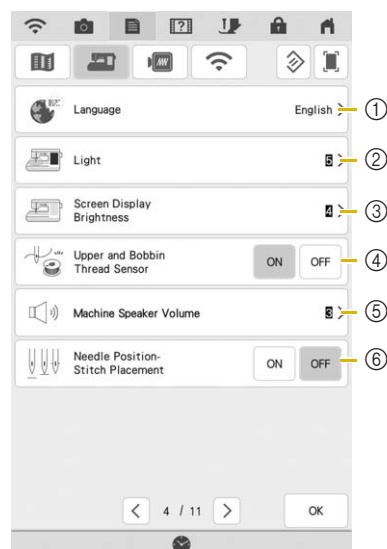

- ① Change the display language.
- ② Change the brightness of the needle area and work area lights.
- ③ If the screen is not very clear in certain environments, you can adjust the brightness of the screen.
- ④ Turn both the upper and bobbin thread sensor “ON” or “OFF”. If it is turned “OFF”, the machine can be used without thread.
- ⑤ Change the speaker volume. Increase the number for louder volume, decrease for softer volume.
- ⑥ Select the operation of the “Needle Position - Stitch Placement” button from the following two sequences. (page 92)

■ Page 5

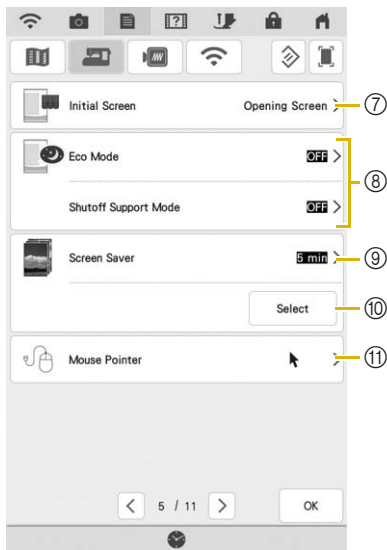

- ⑦ Select whether to display the opening screen video when the machine is turned on.
- ⑧ Select to save the machine power by setting the “Eco Mode” or the “Shutoff Support Mode” (page 34).
- ⑨ Select the length of time until the screen saver appears.
- ⑩ Change the image of the screen saver (page 35).
- ⑪ Change the shape of the pointer when a USB mouse is used. The setting remains selected even after the machine is turned off.

■ Page 6

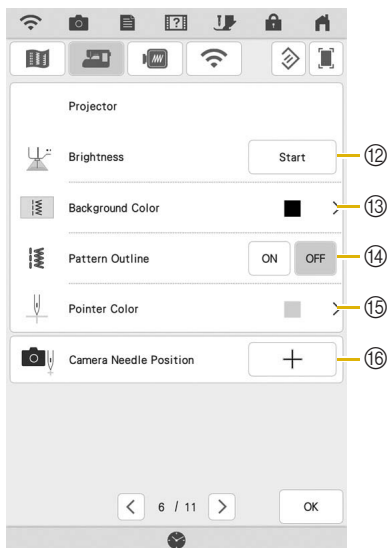

- ⑫ Select the brightness of the projector.
- ⑬ Select whether to show background color when using projector function.
- ⑭ Select whether to display outline of the pattern.
- ⑮ Select the color of the pointer.
- ⑯ The camera needle drop point can be specified. (page 36)

■ Page 7

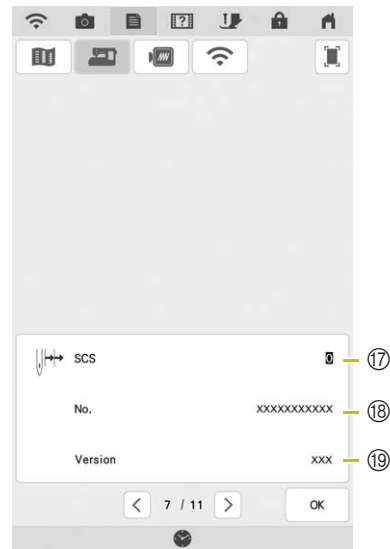

- ⑰ Display the total number of stitches sewn on this machine, which is a reminder to take your machine in for regular servicing. (Contact your authorized Baby Lock retailer for details.)
- ⑱ The “No.” is the internal machine number for the machine.
- ⑲ Display the program version.

Embroidery Settings

For details on embroidering settings, refer to the Instruction and Reference Guide (Embroidery).

Page 8

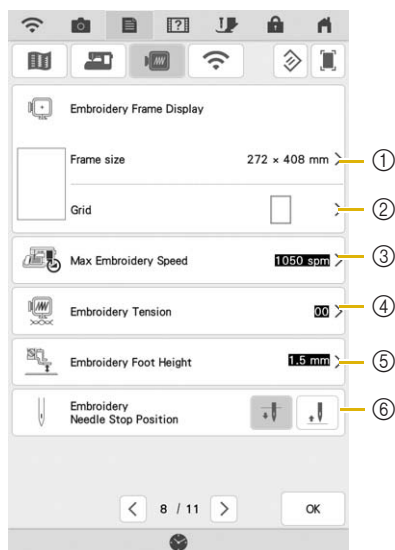

- ① Select from among 12 embroidery frame displays.
- ② Change the center point marker or grid lines.
- ③ Adjust the maximum embroidery speed setting.
- ④ Adjust the upper thread tension for embroidering.
- ⑤ Select the height of the embroidery foot during embroidering.
- ⑥ Adjust the needle position for embroidering.

Page 9

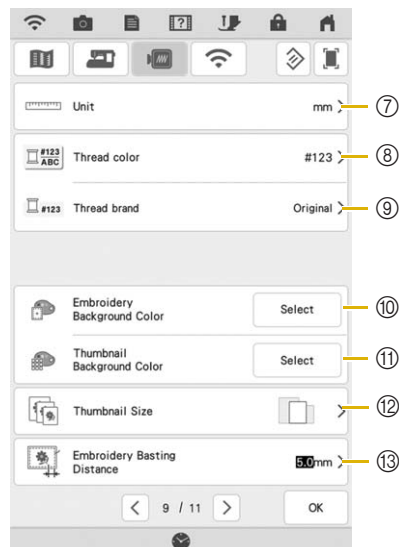

- ⑦ Change the display units (mm/inch).
- ⑧ Change the thread color display on the "Embroidery" screen; thread number, color name.
- ⑨ Select the thread brand used to display a pattern when it is opened.
- ⑩ Change the color of the background for the embroidery display area.
- ⑪ Change the color of the background for the thumbnail area.
- ⑫ Press to specify the size of pattern thumbnails.
- ⑬ Adjust the distance between the pattern and the basting stitching.

Page 10

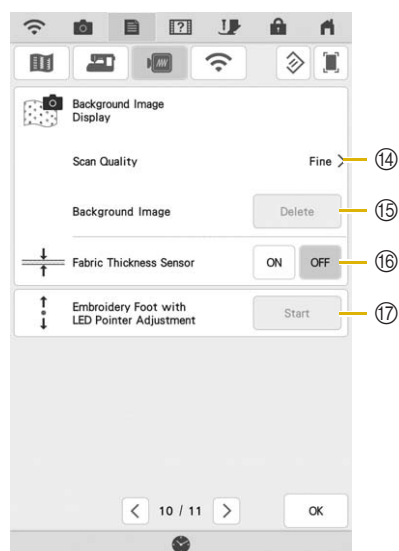

- ⑭ Select the quality for displaying the fabric in the screen.
- ⑮ Erase the scanned image.
- ⑯ Set to "ON" when positioning the pattern on the thick fabric using the built-in camera.
- ⑰ Adjust the position and brightness of the embroidery foot "W+" with LED pointer (sold separately). (These settings are not available unless embroidery foot "W+" with LED pointer is installed on the machine.)

Wireless LAN settings

Page 11

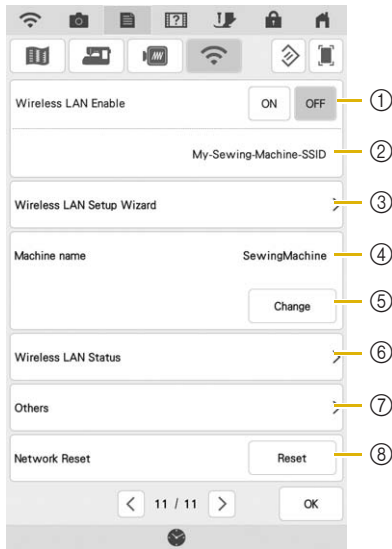

- ① Enable/disable the wireless LAN function.
- ② Display the connected SSID.
- ③ Set the machine to connect wireless LAN function.
- ④ Display the machine name of wireless LAN function.
- ⑤ Press to change the machine name of wireless LAN function.
- ⑥ Check the wireless LAN status.
- ⑦ Display other menus.
- ⑧ Press to reset network operations.

Setting Functions

Saving a Settings Screen Image to USB Media

An image of the settings screen can be saved as .PNG file.

- 1** Insert the USB media into the USB port on the right side of the machine.

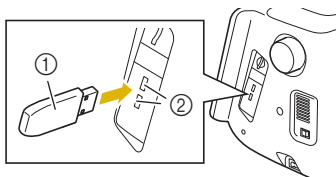

- ① USB media
- ② USB port

- 2** Press .

→ The settings screen appears. Select the settings screen page that you want to save the screen image of.

- 3** Press .

→ The image file will be saved to the USB media.

■ Specifying the Multi-Function Foot Controller (Sold Separately)

With the multi-function foot controller, various machine operations in addition to starting/stopping sewing, such as thread cutting and reverse stitching, can be specified to be performed.

Functions that can be specified

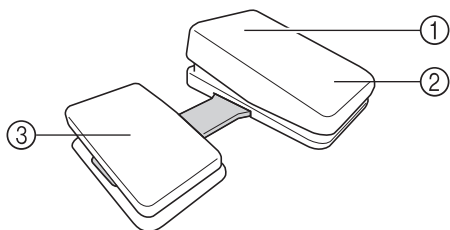

	Controller	Functions that can be specified
①	Main foot controller	Start/Stop
②	Heel switch	Select any of the following: <ul style="list-style-type: none"> • Thread Cutting • Needle Position – Up/Down
③	Side pedal	Select any of the following: <ul style="list-style-type: none"> • Single Stitch • Reverse Stitch (Reinforcement Stitch) * • Presser Foot Up/Down • No Setting

- * If you set the “Reverse Stitch” function on the heel switch, machine operates the same as pressing the “Reverse Button” on the machine.
- * Reinforcement stitching may be applied depending on the selected stitch pattern. For the details, refer to “Automatic Reinforcement Stitching” on page 79.

Memo

- If you set “Reverse Stitch” on the side pedal, you can create a darning stitch effect using zigzag stitches. With both feet, keep pressing the main foot controller, and repeat pressing and releasing the side pedal to sew forward and reverse in turn. Machine will reverse at the speed you press the main foot controller.

Specifying the functions

The functions performed by the multi-function foot controller can be specified in the settings screen.

Note

- Before specifying the functions, connect the multi-function foot controller to the machine. The settings screen is activated the first time that the machine detects the multi-function foot controller.
- After the multi-function foot controller is connected to the machine and the functions are specified, the “Start/Stop” button cannot be used. All buttons other than the “Start/Stop” button can continue to be used.

1 Press .

2 Display page 3 of the settings screen.

3 Select the functions to be performed by the multi-function foot controller.

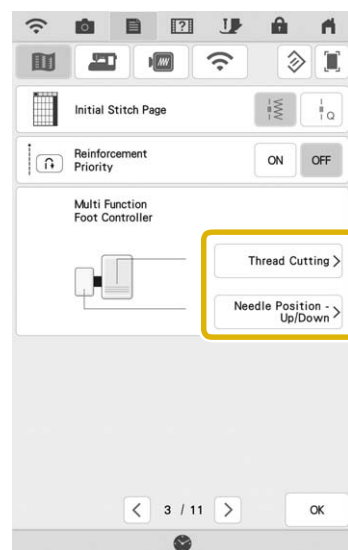

4 Press .

■ Selecting the “Eco Mode” or “Shutoff Support Mode”

You can save the machine power by setting the eco mode or the shutoff support mode. If you leave the machine without using for a specified period of time, the machine enters in one of these modes.

“Eco Mode”;



Machine will enter a sleep mode. Touch the screen or press the “Start/Stop” button to continue sewing.

“Shutoff Support Mode”;

Machine will enter the lower power mode after set period of time. Turn machine off and then back on to restart sewing.

Condition	Eco Mode	Shutoff Support Mode
Available time	OFF, 10 - 120 (minute)	OFF, 1 - 12 (hour)
“Start/Stop” button	Green flashing	Green slow flashing
Suspended function	Machine light, Screen display	All functions
After recovering	The machine starts from the previous operation.	You need to turn off the machine.

Press the “Start/Stop” button or touch the screen display to recover from these modes.

- 1 Press .
 - The settings screen appears.
- 2 Press .
 - The General settings screen appears.
- 3 Display page 5 of the General settings screen.
- 4 Press circled area to select the time until entering the mode.

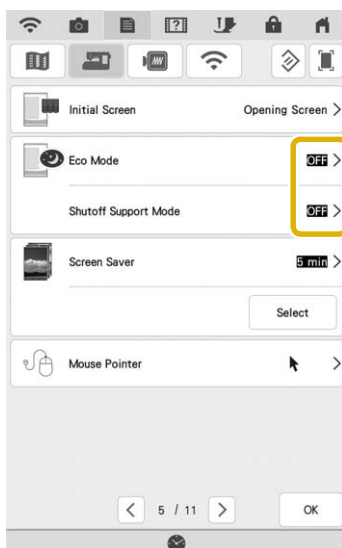

Note

- If you turn off the machine while the machine is in the “Eco Mode” or the “Shutoff Support Mode”, wait for about 5 seconds before turning on the machine again.

■ Changing the Screen Saver Image

Instead of the default image, you can select your own personal images for the screen saver of your machine.

Before changing the screen saver image, prepare the image on your computer or USB media.

Compatible image files

Format	.bmp, .jpg, .png
File size	Max. 2 MB for each image
File dimension	800 × 1280 pixels or less, (If the width is more than 800 pixels, the image imported will be reduced to a width of 800 pixels.)
Number allowed	5 or less

1 Press .

→ The settings screen appears.

2 Press .

→ The General settings screen appears.

3 Display page 5 of the General settings screen.

4 Press .

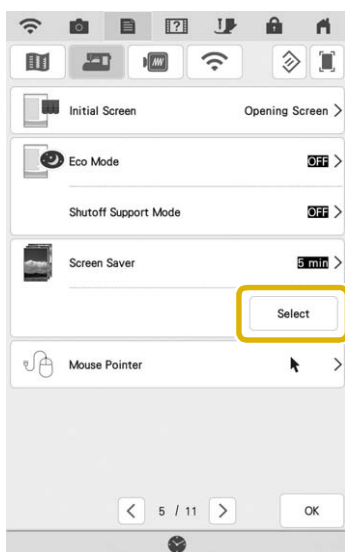

5 Press .

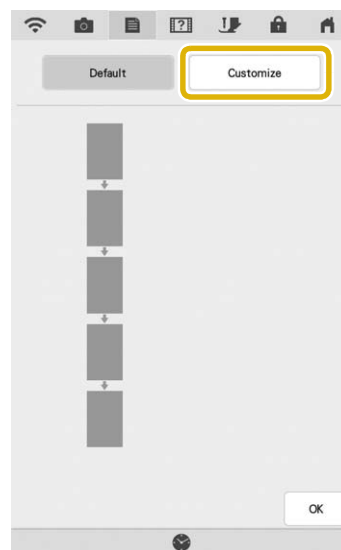

6 Connect the USB media that contains your personal image to the USB port of the machine.

* Refer to page 48 about USB connectivity.

7 Press  to select the first image.

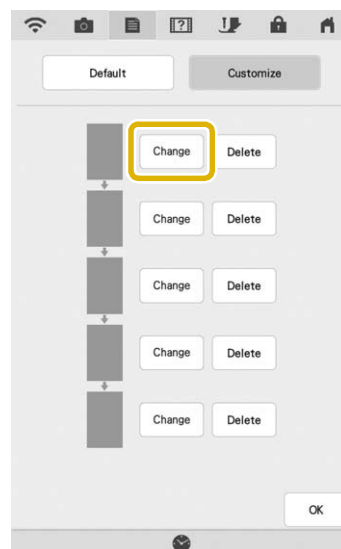

* The images will appear in a list in this screen. Select the desired  to specify the image.

* Press  to delete the selected image.

8 Select the device that is connected.

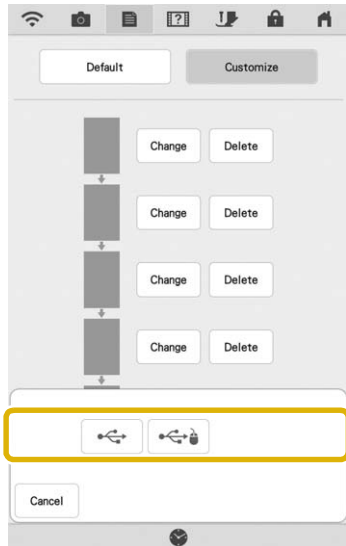

→ A list of your personal images appear on the screen.
 * Press **Cancel** to view the previous page.

9 Press a file name to select image and then press **Set**.



→ The selected image is stored on your machine.
 * Press **Return** to view the previous page.

10 Repeat the procedure from step **7** to select the remaining images.

11 Press **OK** to return to the original screen.

Needle Calibration Using the Built-in Camera

Setting the camera needle position is essential when you use camera or projector function. It is not necessary to perform this operation each time, but we recommend performing it when the needle is changed. Use the white stickers (solid) included with the machine.

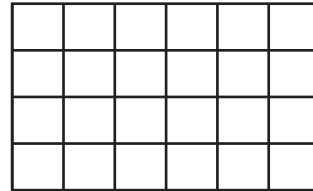

1 Press .

→ The settings screen appears.

2 Press .

→ The General settings screen appears.

3 Display page 6 of the General settings screen.

4 Press .

→ Camera needle position setting screen appears.

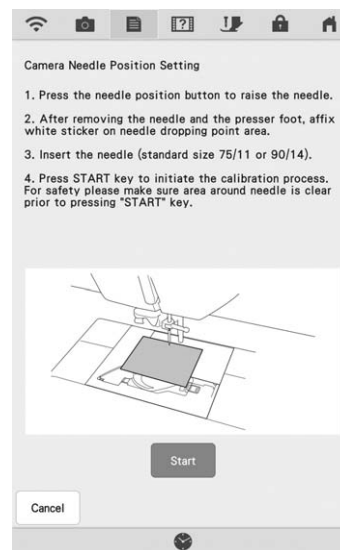

5 Follow the on-screen instructions to complete the procedure.

1. Press the needle position button to raise the needle.

2. After removing the needle and the presser foot, affix white sticker on needle dropping point area.

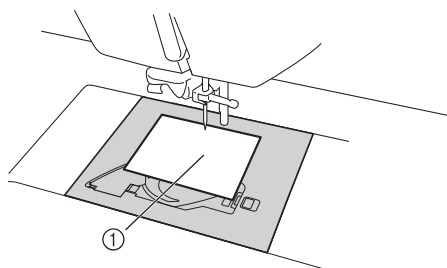

① White sticker

3. Insert the needle (standard size 75/11 or 90/14).



Note

- Use a new sticker. The camera needle position cannot be set correctly if there is a hole in sticker or if it is dirty. If you have no new stickers, contact your nearest authorized Baby Lock retailer.

4. Press to initiate the calibration process. For safety please make sure area around needle is clear prior to pressing



→ Setting the needle drop point begins.

- 6** The operation is finished when “OK” appears. If “NG” appears, affix a new white sticker, and then press . If multiple attempts to set the position are not successful, contact your nearest authorized Baby Lock retailer.

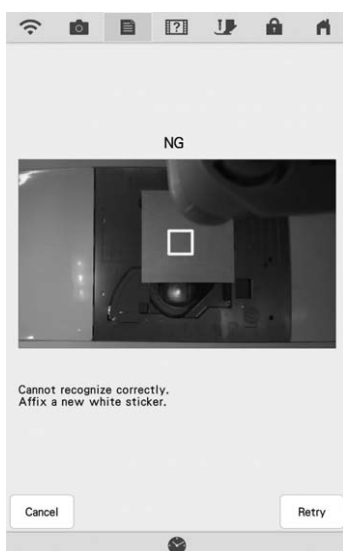

- * Press to memorize the calibration data.
- * Press to back to original screen without memorizing the calibration data.

- 7** Remove the sticker.

Using the Machine Help Key

Press  to open the machine help screen. Six functions are available from the screen shown below.

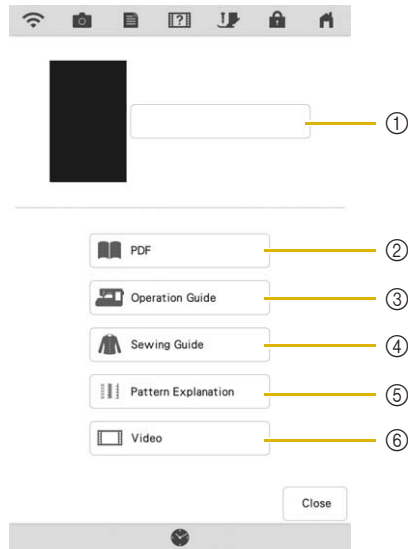

- ① Press this key to continue viewing the Instruction and Reference Guide (PDF file) or watching the video that was stopped.
- ② Press this key to view the Instruction and Reference Guide (PDF file).
- ③ Press this key to see explanation for upper threading, winding the bobbin, changing the presser foot, preparing to embroider a pattern, and how to use the machine (page 39).
- ④ Press this key to select utility stitches when you are not sure which stitch to use or how to sew the stitch (page 40).
- ⑤ Press this key to see an explanation of the selected stitch (page 43).
- ⑥ Press this key to watch tutorial videos or MPEG-4 (MP4) files from USB media (page 41).

Using the Operation Guide Function

Press  Operation Guide to open the screen shown below. Six categories are displayed at the top of the screen. Press a key to see more information about that category.

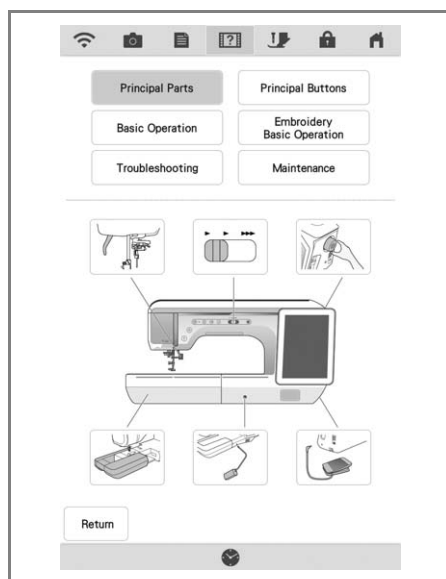

Principal Parts displays information about the main parts of the machine and their functions. This is the first screen displayed when you press .

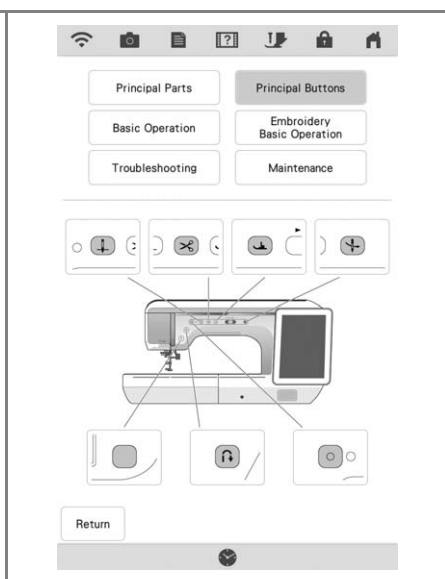

Principal Buttons displays information about the operation buttons.

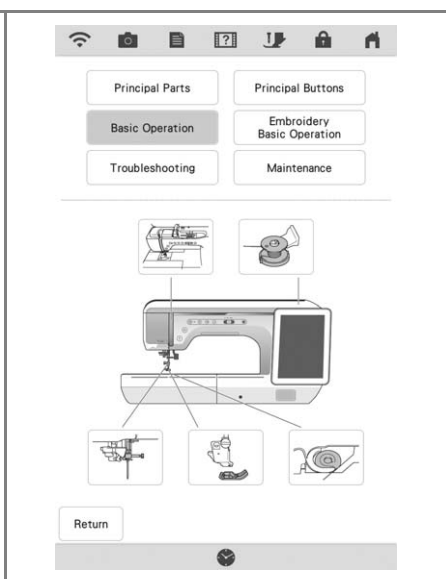

Basic Operation displays information about threading the machine, changing presser feet, etc. Some of the functions are described in the movies. Watch these movies for a better understanding of the functions.

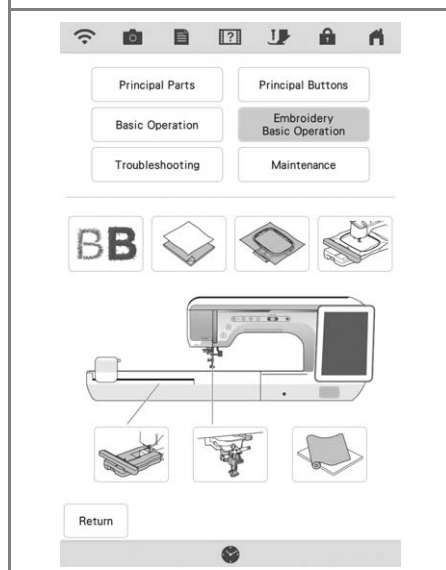

Embroidery Basic Operation displays information about attaching the embroidery unit, preparing fabric for embroidering, etc. Some of the functions are described in the movies. Watch these movies for a better understanding of the functions.

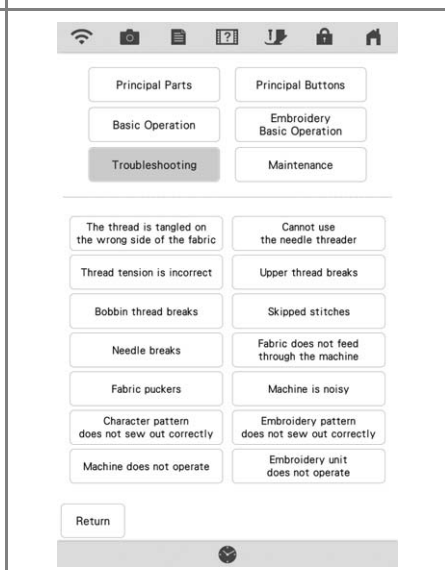

Troubleshooting displays troubleshooting information.

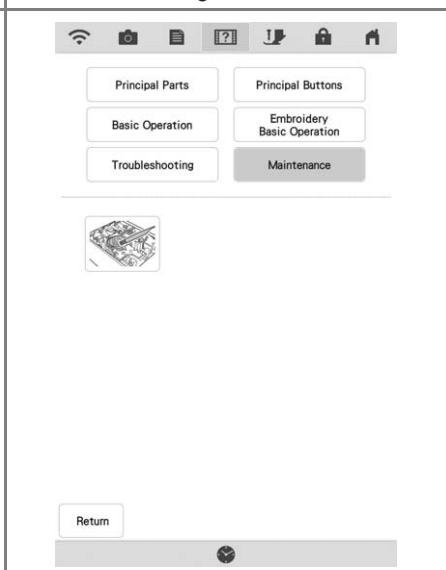

Maintenance displays information about cleaning the machine, etc. Some of the functions are described in the movies. Watch these movies for a better understanding of the functions.

Example: Displaying information about upper threading

1 Press .

2 Press .

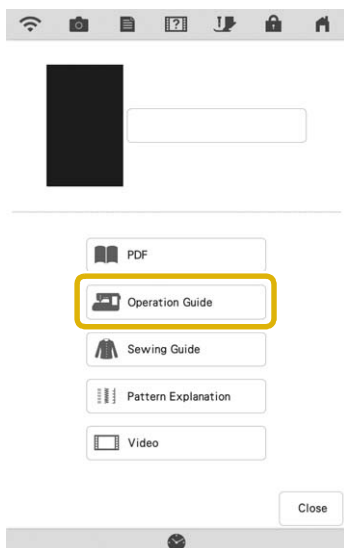

3 Press .

→ The lower half of the screen will change.

4 Press  (upper threading).

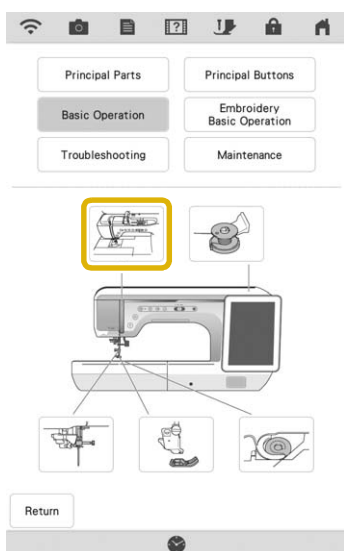

→ The screen shows instructions for threading the machine.

5 Read the instructions.

* Press  to view the next page.

* Press  to view the previous page.

6 Press  to return to the original screen.

Using the Sewing Guide Function

The sewing guide function can be used to select stitch patterns from the Utility Stitch screen. Use this function when you are not sure which stitch to use for your application, or to get advice about sewing particular stitches. For example, if you want to sew overcasting, but you do not know which stitch to use or how to sew the stitch, you can use this screen to get advice. We recommend that beginners use this method to select stitches.

1 Enter Utility Stitch category from the home page.

2 Press .

3 Press .

→ The advice screen is displayed.

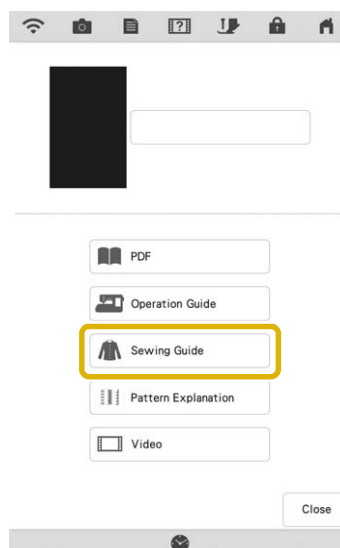

4 Press the key of the category whose sewing instructions you wish to view.

* Press **Return** to return to the original screen.

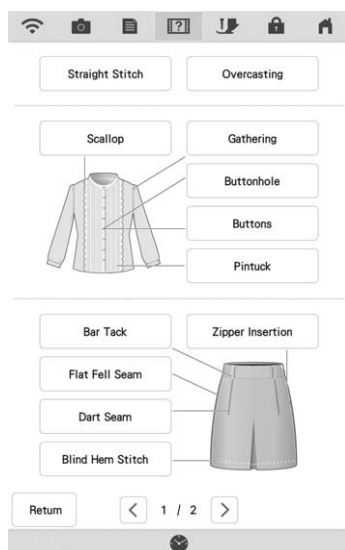

5 Read the explanations and select the appropriate stitch.

→ The screen displays directions for sewing the selected stitch. Follow the directions to sew the stitch.

Playing a Tutorial Video

This machine provides tutorial videos on how to use the machine. Together with the help guides, which offer descriptions through text and illustrations, the tutorial videos assist with machine operation.

1 Press **?**.

2 Press **Video**.

3 Press the title of the desired tutorial video.

→ The selected tutorial video begins playing.

4 Play the tutorial video.

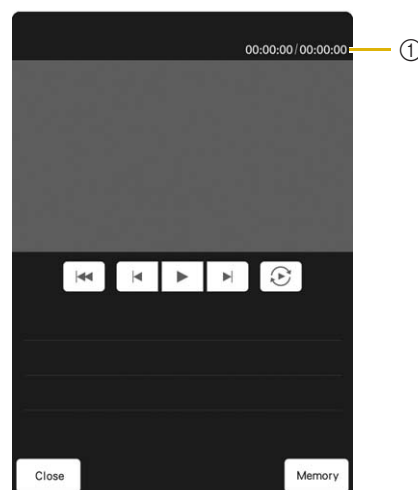

① Number of seconds elapsed/Total number of seconds

Operation keys

	Play
	Pause
	Skip back 10 seconds
	Skip forward 10 seconds
	Return to beginning
	Repeat
	Delete video (when playing from the machine's memory)
	Save to machine (when playing from USB media)

Memo

- A frequently viewed tutorial video can be saved to (favorites) of the machine, from where it can be played.

5 After you are finished playing the video, press **Close**.

Playing MPEG-4 (MP4) Videos

Your MP4 videos can be played from USB media. In addition, the MP4 video can be saved to the machine so that a tutorial video on creating a project, for example, can be viewed at any time.

Videos that can be played

MP4 file format: Video - H.264/MPEG-4 AVC, Audio - AAC
Size: 450 (H) × 800 (W)

Memo

- MP4 file size will be changed to fit the screen. If you view the large MP4 file, the file will be reduced to fit the screen. If you view the smaller MP4 file, the file will be expanded to fit the screen.
- Some type of MP4 file cannot viewed with the machine.

1 Press .

2 Press  Video.

3 Select the device where the video is saved.

: Play a tutorial video

: Play a video saved on the machine (favorites)

: Play a video from USB media plugged into the USB port

: Play a video from USB media plugged into the USB port for mouse

* To return to the previous screen, press .

4 Select the video that you want to play.

* To return to the previous screen, press .

Note

- Long video file names may be shortened when they are displayed.

5 Play the video.

* Use the operation keys as described in "Playing a Tutorial Video" on page 41.

Note

- Up to about 1 GB of MP4 videos can be saved on the machine. When the maximum capacity has been reached, delete unnecessary videos.

6 After you are finished playing the video, press .

Using the Stitch Pattern Explanation Function

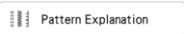
If you want to know more about the uses of a stitch pattern, select the stitch pattern and press  and then  to see an explanation of the stitch selection. Descriptions are displayed for each stitch pattern in the Utility Stitch screen.



Note

- With the stitch pattern explanation function, descriptions can be displayed for the stitch patterns available on the Utility Stitch and Character/Decorative Stitch screens.

Example: Displaying information about 

1 Press .

2 Press .

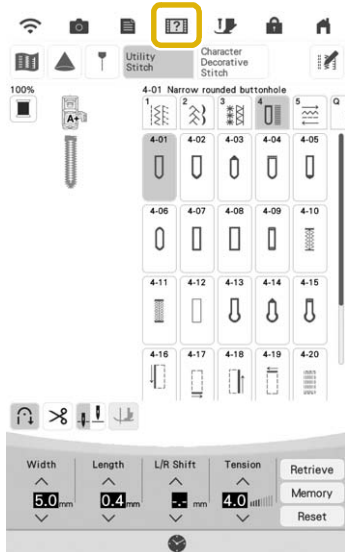

3 Press .

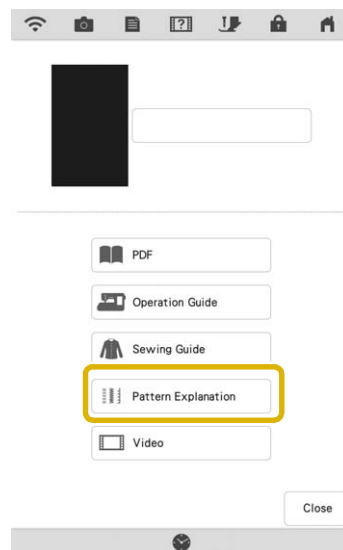

→ The screen shows information.

4 Press  to return to the original screen.



Memo

- The settings remain displayed to allow you to fine tune the stitch.

Viewing the Instruction and Reference Guide (PDF File) on the Machine

The Instruction and Reference Guide (PDF file) for this machine can be viewed on the machine.

1 Press .

2 Press  PDF.

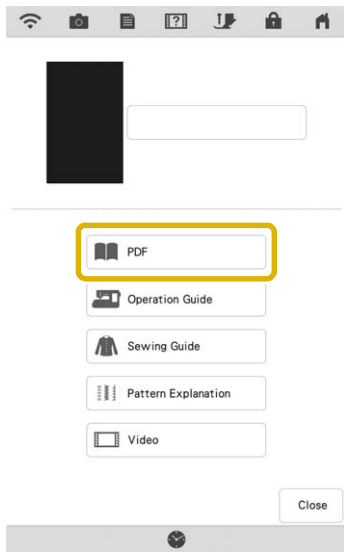

3 Select the document to be viewed.





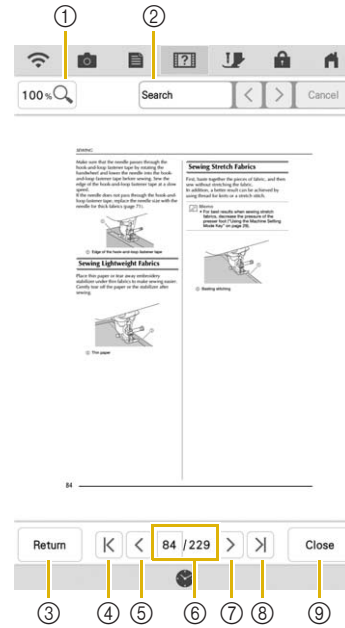

Memo

- The Instruction and Reference Guide can be viewed in the currently selected display language. For details on selecting the display language, refer to “Page 4” on page 29.

4 Read the Instruction and Reference Guide.

Operation keys



①		Press to select from 100%, 200% and 400%.
②	<input type="text" value="Search"/>	1. Press to display a keyboard. 2. Enter the text to be searched for. 3. To search from the current page to the beginning of the document, press  . To search from the current page to the end of the document, press  .
③	<input type="button" value="Return"/>	Press to return to the screen before the Instruction and Reference Guide (PDF file) was opened.
④	<input type="button" value="K"/>	Press to display the first page.
⑤		Press to display the previous page.
⑥	<input type="text" value="84 / 229"/>	Shows the current page/total number of pages. Press the current page number, and then enter a page number to display the desired page.
⑦		Press to display the next page.
⑧		Press to display the last page.
⑨	<input type="button" value="Close"/>	Press to close the screen and exit the machine help screen.

Memo

- To zoom in or out on a page, pinch two fingers together or spread them apart. You can also move a page after zooming in by dragging it.

WIRELESS NETWORK CONNECTION FUNCTIONS

This machine supports a wireless network connection. Using this function, an embroidery pattern or decorative stitch pattern edited in embroidery editing software (Palette 11) with wireless transfer functions can be transferred to the machine from a computer. In addition, embroidery patterns can be transferred from the machine to the embroidery editing software (Palette 11). The machine and computer must be connected to the same network. For detailed procedures, refer to the manual for the application.

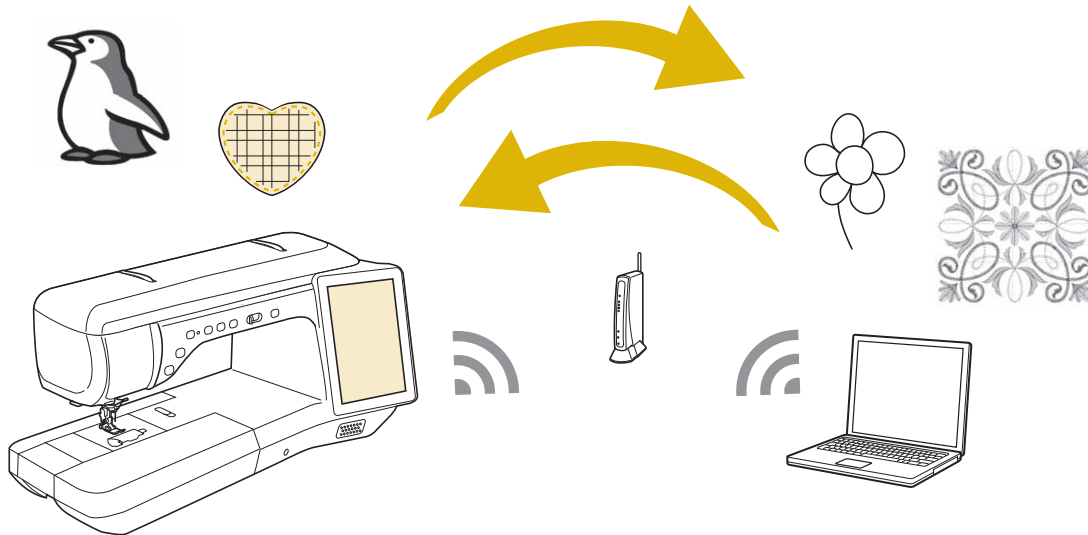

Specifying Wireless Network Connection Settings

The machine can be connected to your wireless network.

- 1 Press .
- 2 Set "Wireless LAN Enable" to "ON".

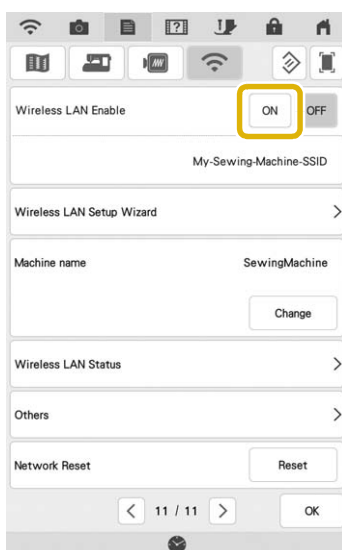

→ The machine will begin to emit the wireless network signal.

Requirements for a Wireless Network Connection

The wireless network connection complies with IEEE 802.11 n/g/b standards and uses the 2.4 GHz frequency.



Memo

- A wireless network cannot be set up with WPA/WPA2 Enterprise.

Using the Wizard to Set Up the Wireless Network Connection

There are multiple ways to set up the wireless network connection. We recommend the method that uses the wizard on this machine.

- 1** In order to connect your machine to a wireless network, the security information (SSID and network key) for your home network will be required. The network key may also be called a password, security key or encryption key. First, find your security information and note it.

SSID	Network Key (Password)

Memo

- The wireless network connection cannot be set up if you do not have the security information.
- How to find the security information
 - ① Check the manual provided with your home network.
 - ② The default SSID may be the manufacturer's name or the model name.
 - ③ If you cannot find the security information, contact the manufacturer of the router, your network administrator or your Internet provider.

- 2** Press > beside "Wireless LAN Setup Wizard".

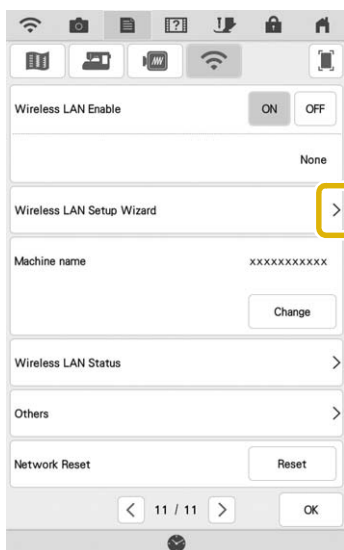

→ A list of available SSIDs appears.

- 3** Select > beside the SSID that was noted.

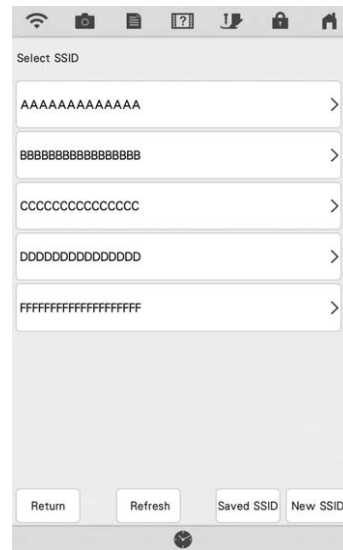

→ The screen for entering the network key (password) appears.

Memo

- If the desired network SSID does not appear in the list, press .
- If the desired network SSID is not displayed, specify it as described below.
 - ① Select in the list of SSIDs, and then press .
 - ② Enter the desired network SSID, and then press .
 - ③ Select the authentication method and encryption mode.
- If the machine had already been connected to the home network, press , and then select the saved SSID.

4 Enter the network key (password) that was noted, and then press .

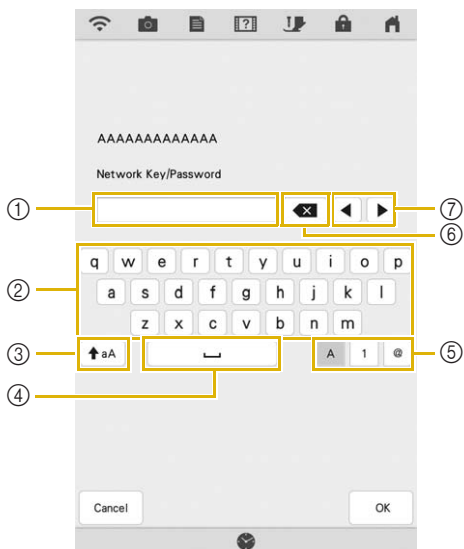

- ① Text input area
- ② Character keys
- ③ Caps key
- ④ Space key
- ⑤ Letters/numbers/symbols key
- ⑥ Backspace key (Deletes the character at the cursor's position.)
- ⑦ Cursor keys (Move the cursor to the left or right.)

5 When the following message appears, press .



→ When a connection is established, the following message appears.

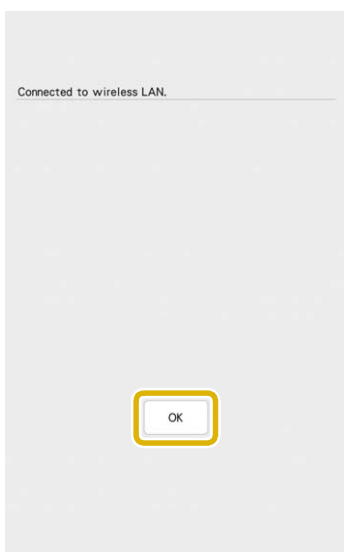

6 Press to exit the setup.

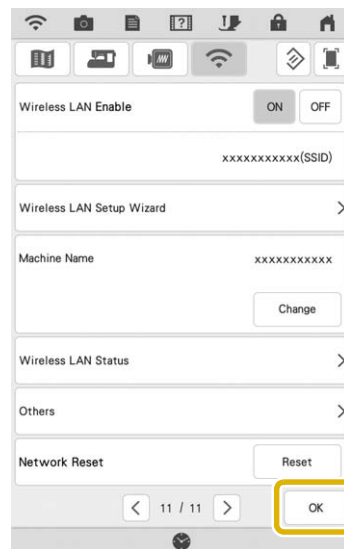

→ The number beside "Machine Name" is the name that will be used when registering the machine with embroidery editing software (Palette 11) in order to transfer files.

Memo

- While connected, the signal strength is indicated by the icon in the upper-left corner of the display.
- Once a wireless network connection has been set up, a wireless network connection will be established each time the machine is turned on. However, "Wireless LAN Enable" in the network settings screen must remain set to "ON".

Using the "Others" Menu

The "Others" menu contains the following items.

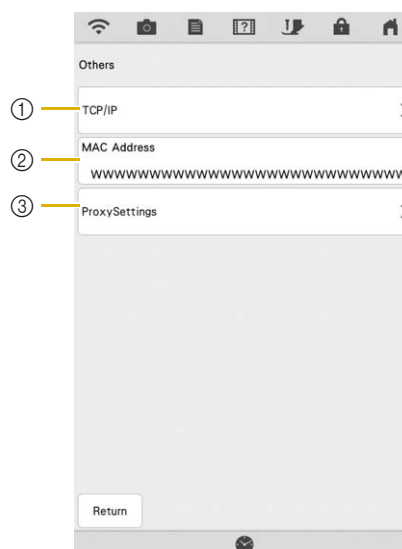

- ① TCP/IP settings can be manually entered.
- ② Shows the MAC address.
- ③ Use when proxy settings are required.

CONNECTING THE ACCESSORY TO THE MACHINE

Using USB Media/SD card (Sold Separately)

When sending or reading stitch patterns using the USB media, connect the device to the USB port. When using SD card, insert the SD card into the SD card slot.

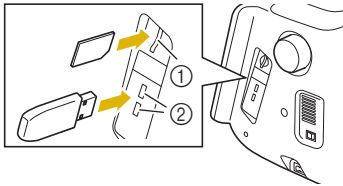

- ① SD card slot
- ② USB port

Memo

- USB media is widely used, however some USB media may not be usable with this machine. Please visit our website for more details.
- Depending on the type of USB media being used, either directly plug the USB device into the machine's USB port or plug the USB media Reader/Writer into the machine's USB port.
- Do not insert anything other than USB media into the USB media port. Otherwise, the machine may be damaged.
- Do not insert anything other than SD card into the SD card slot. Otherwise, the machine may be damaged.

Using a USB Mouse (Sold Separately)

The USB mouse, connected to the machine, can be used to perform a variety of operations in the screens.

Connect a USB mouse to the USB port.



Memo

- If a mouse other than the optional USB mouse is used, it may not perform as described in this Instruction and Reference Guide.

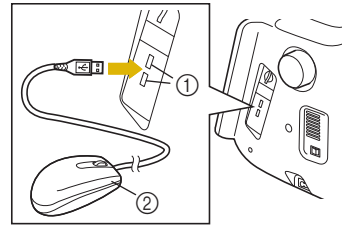

- ① USB port
- ② USB mouse



Note

- A USB mouse can be connected or disconnected at any time.
- Only the left mouse button can be used to perform operations. No other buttons can be used.
- The mouse pointer does not appear in the camera view window, the screen saver or opening screen.

■ Clicking a Key

When the mouse is connected, the pointer appears on the screen. Move the mouse to position the pointer over the desired key, and then click the left mouse button.



Memo

- Double-clicking has no effect.

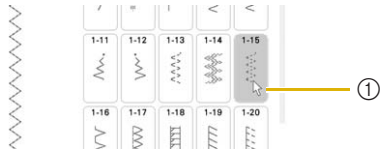

① Pointer

■ Changing Pages

If page numbers and a vertical scroll bar for additional pages are displayed, click the left mouse button with the pointer on </> or ^/∨ to display the previous or next page.





Chapter **2**
Sewing Basics



LOWER THREADING

Winding the Bobbin

⚠ CAUTION

- The included bobbin was designed specifically for this machine. If bobbins from other models are used, the machine will not operate correctly. Use only the included bobbin or bobbins of the same type (part code: X52800-150). X52800-150 is Class 15 type bobbin.

■ Using the Supplemental Spool Pin

With this machine, you can wind the bobbin during sewing. While the main spool pin is being used for sewing, you can wind a bobbin by using the supplemental spool pin.

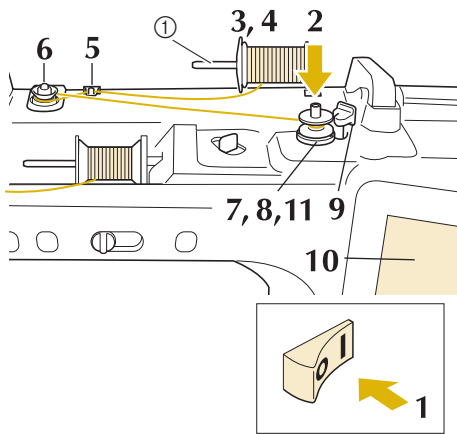

① Supplemental spool pin

- Turn the main power to ON and open the top cover.
- Align the groove in the bobbin with the spring on the bobbin winder shaft, and set the bobbin on the shaft.

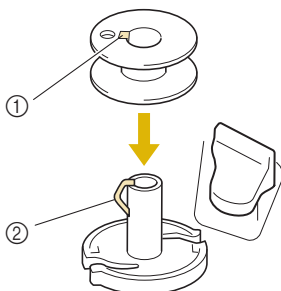

① Groove in the bobbin
② Spring on the shaft

- Set the supplemental spool pin in the “up” position.

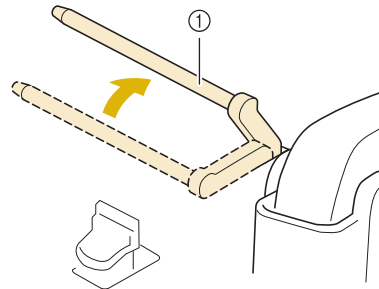

① Supplemental spool pin

- Place the spool of thread on the supplemental spool pin, so that thread unrolls from the front. Push the spool cap onto the spool pin as far as possible to secure the thread spool.

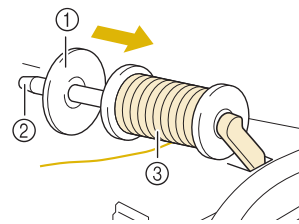

① Spool cap
② Spool pin
③ Thread spool

⚠ CAUTION

- If the thread spool and/or spool cap are set incorrectly, the thread may tangle on the spool pin and cause the needle to break.
- Use the spool cap (large, medium, small or mini king) that is closest in size to the thread spool. If a spool cap smaller than the thread spool is used, the thread may become caught in the slit on the end of the spool and cause the needle to break.

Memo

- When sewing with fine, cross-wound thread, use the small spool cap, and leave a small space between the cap and the thread spool.

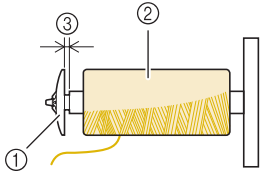

- ① Spool cap (small)
- ② Thread spool (cross-wound thread)
- ③ Space

- If a spool of thread whose core is 12 mm (1/2 inch) in diameter and 75 mm (3 inches) high is inserted onto the spool pin, use the mini spool cap.

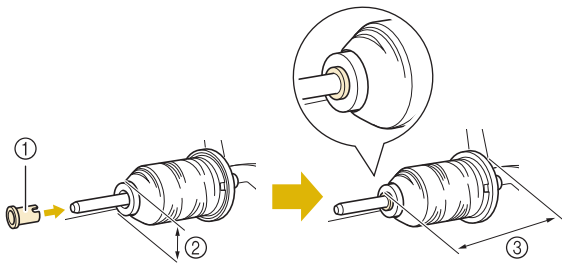

- ① Spool cap (mini king spool insert)
- ② 12 mm (1/2 inch)
- ③ 75 mm (3 inches)

- 5** With your right hand, hold the thread near the thread spool. With your left hand, hold the end of the thread, and use both hands to pass the thread through the thread guide.

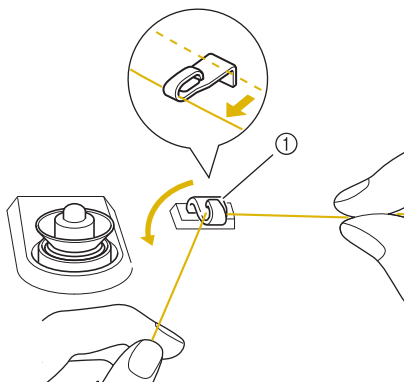

- ① Thread guide

- 6** Pass the thread around the pretension disk making sure that the thread is under the pretension disk.

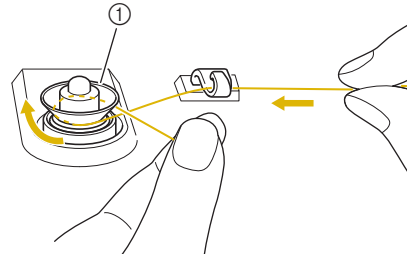

- ① Pretension disk
→ Make sure that the thread passes under the pretension disk.

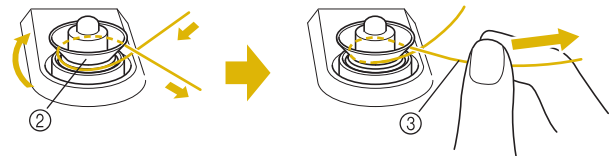

- ② Pretension disk
- ③ Pull it in as far as possible.
→ Check to make sure thread is securely set between pretension disks.

- 7** Wind the thread clockwise around the bobbin 5-6 times.

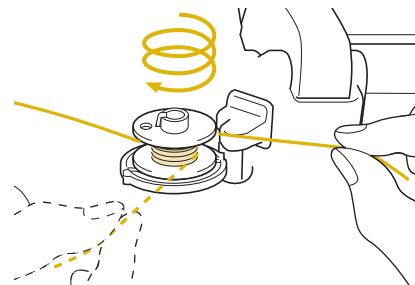

- 8** Pass the end of the thread through the guide slit in the bobbin winder seat, and pull the thread to the right to cut the thread with the cutter.

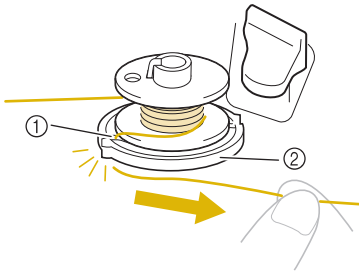

- ① Guide slit (with built-in cutter)
- ② Bobbin winder seat

⚠ CAUTION

- Be sure to follow the process described. If the thread is not cut with the cutter, and the bobbin is wound, when the thread runs low it may tangle around the bobbin and cause the needle to break.

- 9** Set the bobbin winding switch to the left, until it clicks into place.

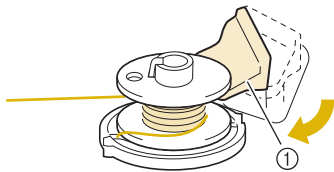

- ① Bobbin winding switch

📖 Memo

- Sliding the bobbin winding switch to the left switches the machine into bobbin winding mode.
- Use the bobbin winding slider to adjust the amount of thread wound onto the bobbin to one of five levels.

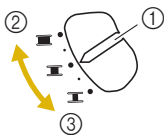

- ① Bobbin winding slider
- ② More
- ③ Less

→ The bobbin winding window appears.

💡 Note

- When winding transparent nylon thread on the bobbin, stop bobbin winding when the bobbin is 1/2 to 2/3 full. If the bobbin was fully wound with transparent nylon thread, it may not be wound neatly.

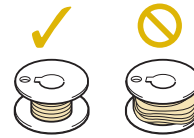

- 10** Press .

→ Bobbin winding starts. The bobbin stops rotating when bobbin winding is completed. The bobbin winding switch will automatically return to its original position.

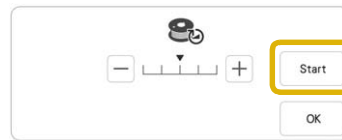

💡 Note

- changes to while the bobbin is winding.
- Stay near the machine while winding the bobbin to make sure the bobbin thread is being wound correctly. If the bobbin thread is wound incorrectly, press immediately to stop the bobbin winding.
- The sound of winding the bobbin with stiff thread, such as nylon thread for quilting, may be different from the one produced when winding normal thread; however, this is not a sign of a malfunction.

Memo

- You can change the winding speed by pressing **-** (to decrease) or **+** (to increase) in the bobbin winding window.



- Press **OK** to minimize the bobbin winding window. Then, you can perform other operations, such as selecting a stitch or adjusting the thread tension, while the bobbin is being wound.
- Press **Ⓢ** (in top right of the LCD screen) to display the bobbin winding window again.



11 Cut the thread with cutter and remove the bobbin.

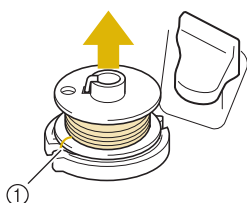

① Cutter

Memo

- When removing the bobbin, do not pull on the bobbin winder seat. Doing so could loosen or remove the bobbin winder seat, and could result in damage to the machine.

CAUTION

- Setting the bobbin improperly may cause the thread tension to loosen, breaking the needle and possibly resulting in injury.

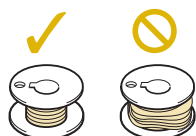

Using the Spool Pin

You can use the main spool pin to wind the bobbin before sewing. You cannot use this spool pin to wind the bobbin while sewing.

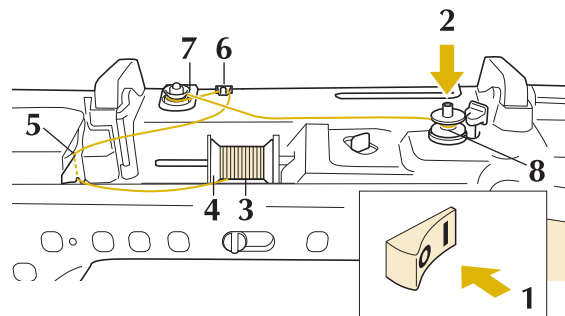

- Turn the main power to ON and open the top cover.
- Align the groove in the bobbin with the spring on the bobbin winder shaft, and set the bobbin on the shaft.

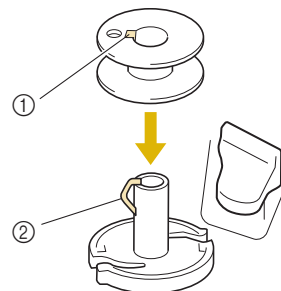

- ① Groove in the bobbin
- ② Spring on the shaft

- Pivot the spool pin so that it angles upward. Set the thread spool on the spool pin so that the thread unwinds from the front of the spool.

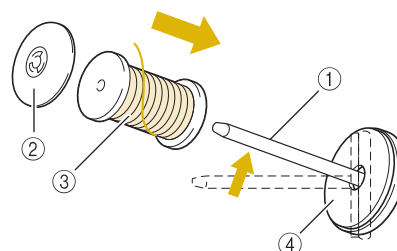

- ① Spool pin
- ② Spool cap
- ③ Thread spool
- ④ Spool felt

4 Push the spool cap onto the spool pin as far as possible, then return the spool pin to its original position.

5 While holding the thread with both hands, pull the thread up from under the thread guide plate.

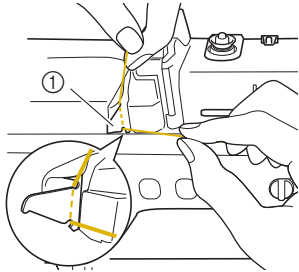

① Thread guide plate

6 Pass the thread through the thread guide.

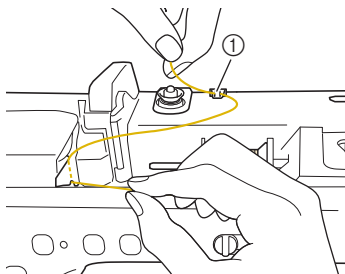

① Thread guide

7 Pass the thread around the pretension disk making sure that the thread is under the pretension disk.

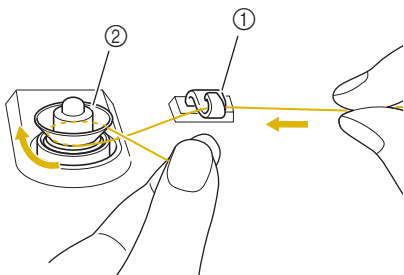

① Thread guide
② Pretension disk

8 Follow steps **7** through **11** on page 53 through 55.

■ Using the Spool Stand

To wind thread on the bobbin while the spool stand is installed, pass the thread from the spool through the thread guide on the telescopic thread guide, and then wind the bobbin according to steps **5** through

11 of “Using the Supplemental Spool Pin” on page 53 to page 55.

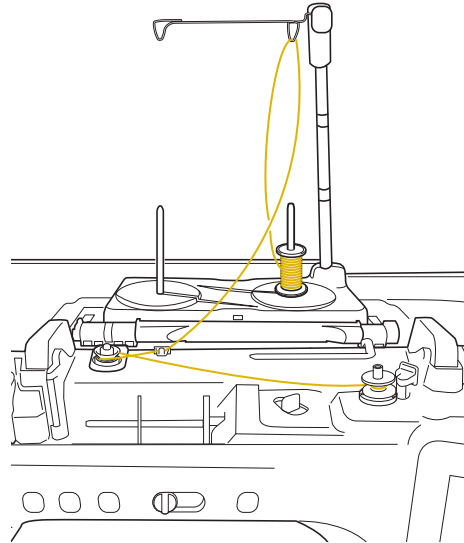

Memo

- Refer to page 24 to assemble the spool stand.
- Refer to page 66 to thread the machine using the spool stand.

⚠ CAUTION

- When winding thread on the bobbin, do not cross the bobbin winding thread with the upper thread in the thread guides.

■ Untangling Thread from Beneath the Bobbin Winder Seat

If the bobbin winding starts when the thread is not passed through the pretension disk correctly, the thread may become tangled beneath the bobbin winder seat.

Wind off the thread according to the following procedure.

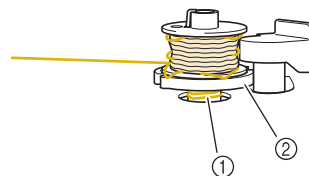

① Thread
② Bobbin winder seat

⚠ CAUTION

- Do not remove the bobbin winder seat even if the thread becomes tangled under the bobbin winder seat. It may result in injuries.

- 1** If the thread becomes tangled under the bobbin winder seat, press **Stop** once to stop the bobbin winding.

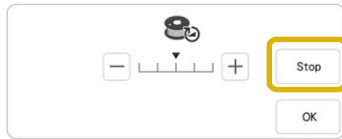

- 2** Cut the thread with scissors near the pretension disk.

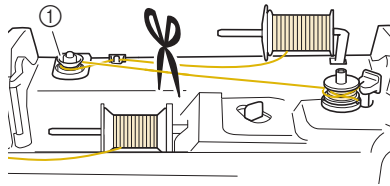

① Pretension disk

- 3** Push the bobbin winder switch to the right, and then raise the bobbin at least 100 mm (4 inches) from the shaft.

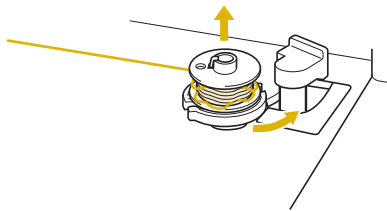

- 4** Cut the thread near the bobbin and hold the thread end of the spool with your left hand. Unwind the thread clockwise near the bobbin winder seat with your right hand as shown below.

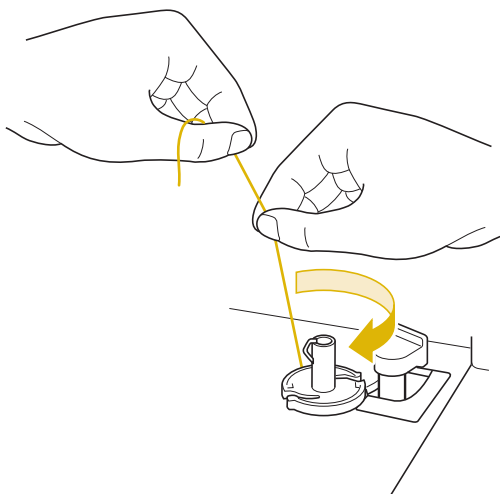

- 5** Wind the bobbin again.



Note

- Make sure that the thread passes through the pretension disk correctly (page 53).

Setting the Bobbin

⚠ CAUTION

- Use a bobbin thread that has been correctly wound. Otherwise, the needle may break or the thread tension will be incorrect.

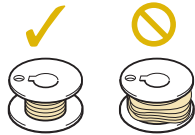

- The included bobbin was designed specifically for this machine. If bobbins from other models are used, the machine will not operate correctly. Use only the included bobbin or bobbins of the same type (part code: X52800-150). X52800-150 is Class 15 type bobbin.
- Before inserting or changing the bobbin, be sure to press  in the LCD to lock all keys and buttons, otherwise injuries may occur if the “Start/Stop” button or any other button is pressed and the machine starts sewing.

- 1 Press  to lock all keys and buttons and raise the presser foot.

* If the message “OK to automatically lower the presser foot?” appears on the LCD screen, press

 to continue.

- 2 Slide the bobbin cover latch to the right.

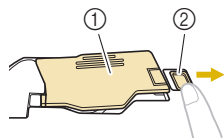

① Bobbin cover

② Latch

→ The bobbin cover opens.

- 3 Remove the bobbin cover.

- 4 Hold the bobbin with your right hand and hold the end of the thread with your left hand.

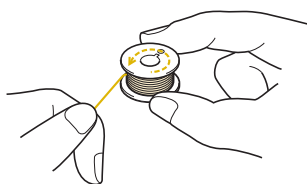

- 5 Set the bobbin in the bobbin case so that the thread unwinds to the left.

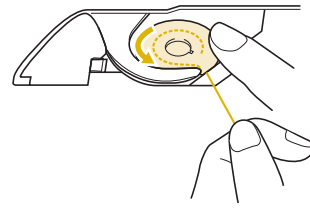

- 6 Hold the bobbin lightly with your right hand, and then guide the thread with your left hand.

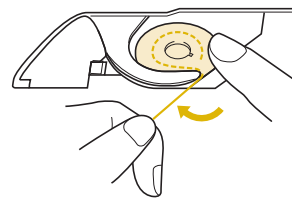

- 7 Pass the thread through the guide, and then pull the thread out toward the front.

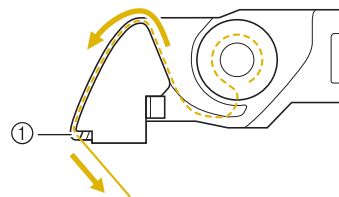

① Cutter

→ The cutter cuts the thread.

**Note**

- If the thread is not correctly inserted through the tension spring of the bobbin case, it may cause incorrect thread tension. (page 87)

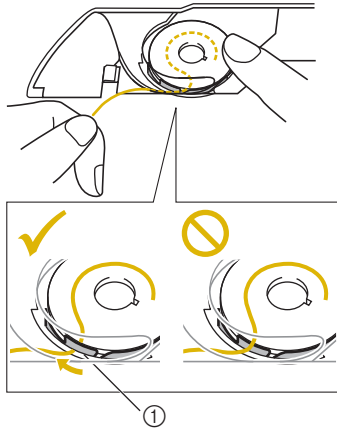

① Tension spring

⚠ CAUTION

- Be sure to hold down the bobbin with your finger and unwind the bobbin thread correctly. Otherwise, the thread may break or the thread tension will be incorrect.

- 8** Insert the tab in the lower-left corner of the bobbin cover (1), and then lightly press down on the right side to close the cover (2).

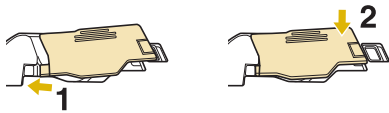

- 9** Press  to unlock all keys and buttons.

Pulling Up the Bobbin Thread

There may be some sewing applications where you want to pull up the bobbin thread; for example, when making gathers, darts, or doing free motion quilting or embroidery.

**Memo**

- You can pull up the bobbin thread after threading the upper thread (“UPPER THREADING” on page 61).

- 1** Follow steps ① to ④ in “Setting the Bobbin” on page 58 for installing the bobbin into the bobbin case.
- 2** Guide the bobbin thread through the groove, following the arrow in the illustration.

- * Do not cut the thread with the cutter.
- * Do not replace the bobbin cover.

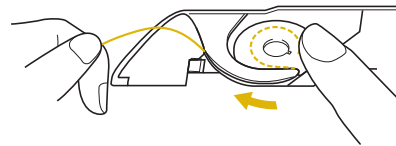

- 3** While holding the upper thread, press the “Needle Position” button to lower the needle.

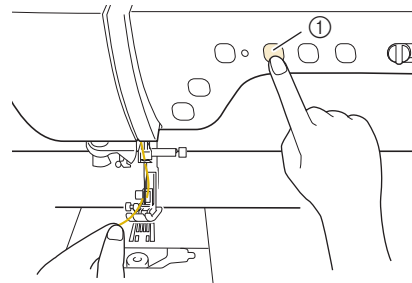

① “Needle Position” button

- 4** Press the “Needle Position” button to raise the needle.
- 5** Gently pull the upper thread. A loop of the bobbin thread will come out of the hole in the needle plate.

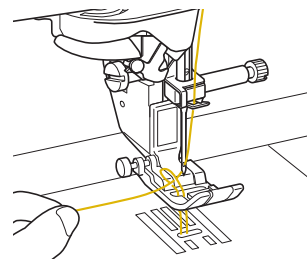

- 6** Pull up the bobbin thread, pass it under the presser foot and pull it about 100 mm (approx. 3-4 inches) toward the back of the machine, making it even with the upper thread.

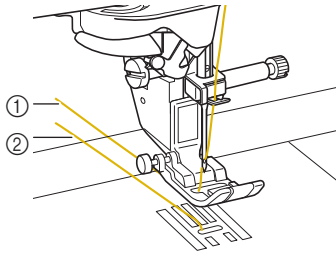

- ① Upper thread
- ② Bobbin thread

- 7** Replace the bobbin cover.

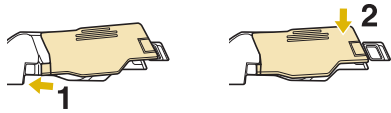

UPPER THREADING

Upper Threading

⚠ CAUTION

- Be sure to thread the machine properly. Improper threading can cause the thread to tangle and break the needle, leading to injury.
- When using the walking foot, the side cutter or accessories not included with this machine, attach the accessory to the machine after threading the machine.

📖 Memo

- The automatic threading function can be used with home sewing machine needle sizes 75/11 through 100/16.
- When threads such as transparent nylon monofilament or speciality threads are used it is not recommended to use the needle threader.
- The automatic threading function cannot be used with the wing needle or the twin needle.

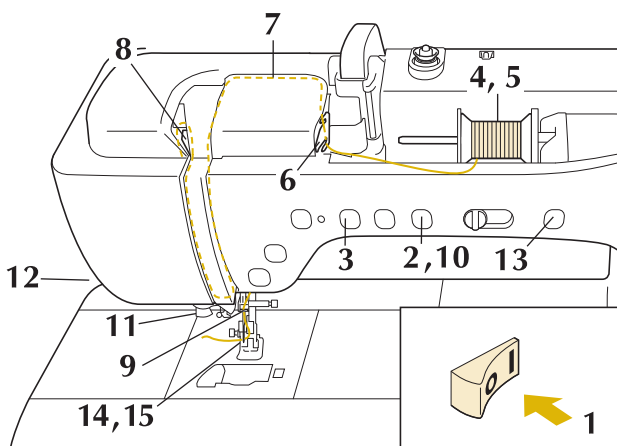

1 Turn the main power to ON.

2 Press the “Presser Foot Lifter” button to raise the presser foot.

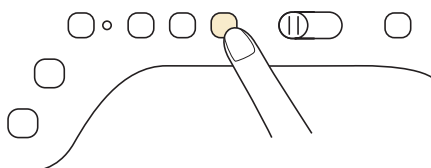

→ The upper thread shutter opens so the machine can be threaded.

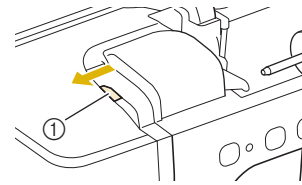

① Upper thread shutter

📖 Memo

- This machine is equipped with an upper thread shutter, allowing you to check that the upper threading is performed correctly.

3 Press the “Needle Position” button to raise the needle.

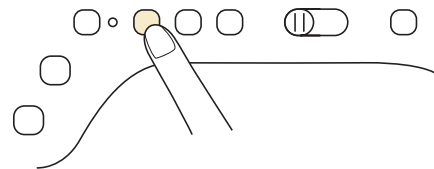

💡 Note

- If you try to thread the needle automatically without raising the needle, the thread may not thread correctly.

4 Pivot the spool pin so that it angles upward. Set the thread spool on the spool pin so that the thread unwinds from the front of the spool.

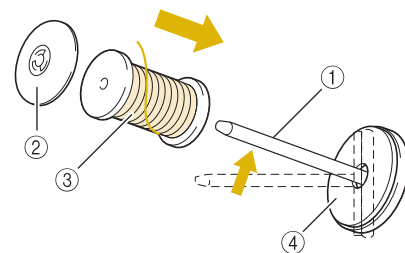

- ① Spool pin
- ② Spool cap
- ③ Thread spool
- ④ Spool felt

- 5** Push the spool cap onto the spool pin as far as possible, then return the spool pin to its original position.

⚠ CAUTION

- If the thread spool and/or spool cap are set incorrectly, the thread may tangle on the spool pin and cause the needle to break.
- Use the spool cap (large or medium) or the thread spool insert (mini king spool insert) that is closest in size to the thread spool. If a spool cap smaller than the thread spool is used, the thread may become caught in the slit on the end of the spool and cause the needle to break.

📖 Memo

- When sewing with fine, cross-wound thread, use the small spool cap, and leave a small space between the cap and the thread spool.

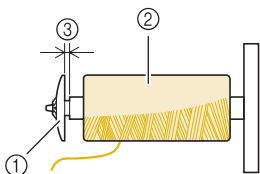

- ① Spool cap (small)
- ② Thread spool (cross-wound thread)
- ③ Space

- If a spool of thread whose core is 12 mm (1/2 inch) in diameter and 75 mm (3 inches) high is inserted onto the spool pin, use the thread spool insert (mini king spool insert).

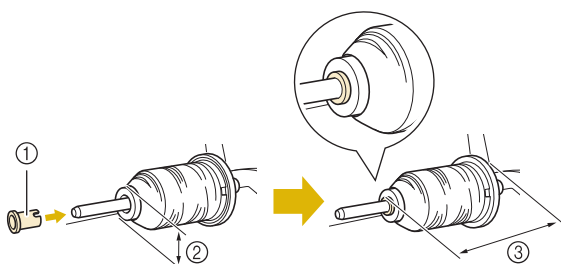

- ① Thread spool insert (mini king spool insert)
- ② 12 mm (1/2 inch)
- ③ 75 mm (3 inches)

- 6** While holding the thread with both hands, pull the thread up from under the thread guide plate.

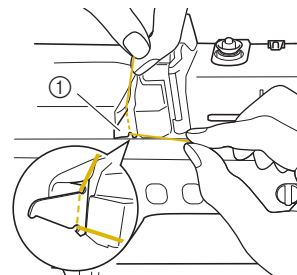

- ① Thread guide plate

- 7** While holding the thread in your right hand, pass the thread through the thread guide in the direction indicated.

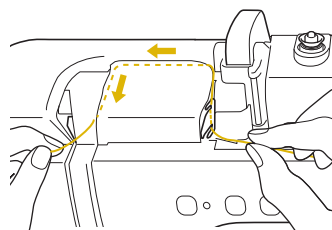

- 8** Guide the thread down, up, then down through the groove, as shown in the illustration.

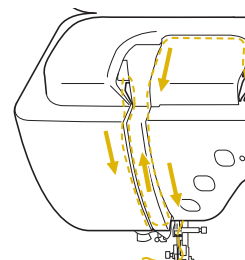

📖 Memo

- Look in the upper groove area to check if the thread catches on the thread take-up lever visible inside the upper groove area.

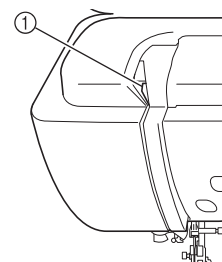

- ① Look in the upper groove area

9 Pass the thread through the needle bar thread guide (marked "6") by holding the thread with both hands and guiding it as shown in the illustration.

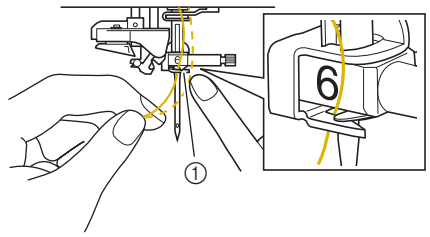

① Needle bar thread guide

10 Press the "Presser Foot Lifter" button to lower presser foot.

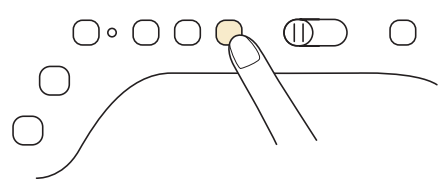

11 Pass the thread through the thread guide disks (marked "7"). Make sure that the thread passes through the groove in the thread guide.

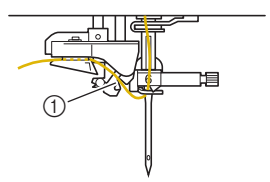

① Groove in thread guide

12 Pull the thread up through the thread cutter to cut the thread, as shown in the illustration.

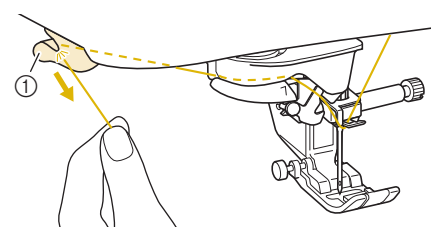

① Thread cutter

Note

- When using thread that quickly winds off the spool, such as metallic thread, it may be difficult to thread the needle if the thread is cut. Therefore, instead of using the thread cutter, pull out about 80 mm (approx. 3 inches) of thread after passing it through the thread guide disks (marked "7").

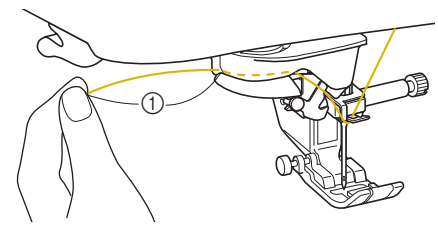

① 80 mm (approx. 3 inches) or more

13 Press the "Automatic Threading" button to have the machine automatically thread the needle.

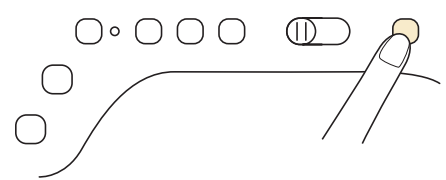

→ The thread passes through the eye of the needle.

Memo

- When the "Automatic Threading" button is pressed, the presser foot will be automatically lowered. After threading is finished, the presser foot moves back to the position before the "Automatic Threading" button was pressed.

14 Carefully pull the end of the thread that was passed through the eye of the needle.

* If a loop was formed in the thread passed through the eye of the needle, carefully pull on the loop of thread through to the back of the needle.

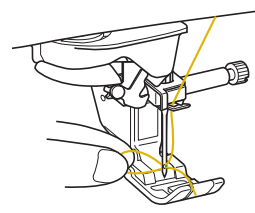

Note

- Pulling the loop of thread gently will avoid needle breakage.

- 15** Pull out about 100-150 mm (approx. 4-6 inches) of the thread, and then pass it under the presser foot toward the rear of the machine.

→ Raise the presser foot lever if the presser foot is lowered.

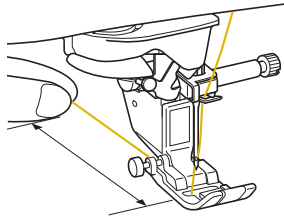

① About 100-150 mm (approx. 4-6 inches)

Memo

- If the needle could not be threaded or the thread was not passed through the needle bar thread guides, perform the procedure again starting from step ③. Then, pass the thread through the eye of the needle after step ⑨.

Note

- Some needles cannot be threaded with the needle threader. In this case, instead of using the needle threader after passing the thread through the needle bar thread guide (marked “6”), manually pass the thread through the eye of the needle from the front.

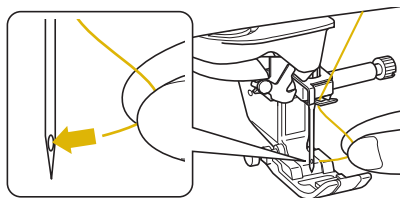

Using the Twin Needle Mode

The twin needle can only be used for stitch patterns that show  after being selected. Before you select a stitch pattern, make sure the stitch can be sewn in the twin needle mode (refer to the “STITCH SETTING CHART” on page 206).

⚠ CAUTION

- Twin needle (part code XE4963-001) is recommended for this machine. Contact your authorized Baby Lock retailer for replacement needles (size 2.0/11 is recommended).
- Be sure to set the twin needle mode when using the twin needle. Using the twin needle while the machine is in single needle mode could cause the needle to break, resulting in damage.
- Do not sew with bent needles. The needle could break and cause injury.
- When using the twin needle, it is recommended to use presser foot “J”.
- When the twin needle is used, bunched stitches may occur depending on the types of fabric and thread that are used. Use monogramming foot “N” for decorative stitches.
- Before changing the needle or threading the machine, be sure to press  on the LCD Screen to lock all keys and buttons, otherwise injuries may occur if the “Start/Stop” button or any other button is pressed and the machine starts sewing.

- 1** Press  to lock all keys and buttons and then install the twin needle (“CHANGING THE NEEDLE” on page 69).

* If the message “OK to automatically lower the presser foot?” appears on the LCD screen, press

 to continue.

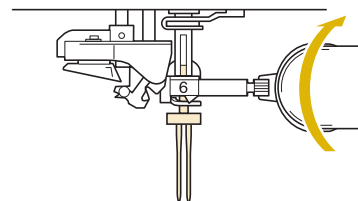

- 2** Thread the machine for the first needle according to the procedure for threading a single needle (“Upper Threading” on page 61).

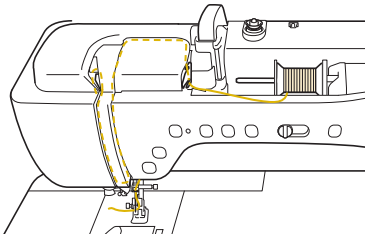

- 3** Pass the thread through the needle bar thread guides on the needle bar, then thread the needle on the left side manually.

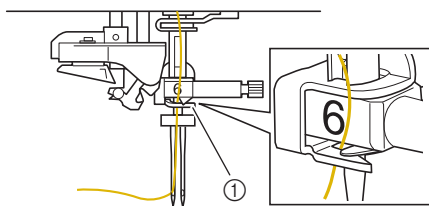

① Needle bar thread guide



Note

- The “Automatic Threading” button cannot be used. Manually thread the twin needle from front to back. Using the “Automatic Threading” button may result in damage to the machine.

- 4** Pull up the supplemental spool pin and set it in the up position.

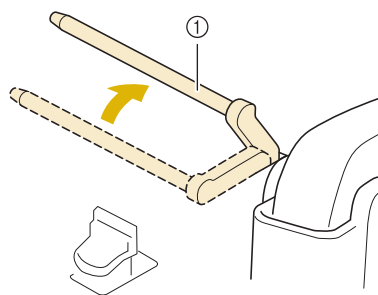

① Supplemental spool pin

- 5** Place the additional spool of thread on the supplemental spool pin, so that the thread unwinds from the front. Push the spool cap onto the spool pin as far as possible to secure the thread spool.

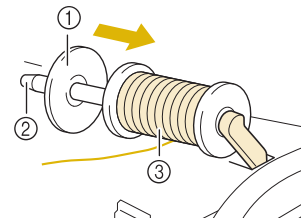

- ① Spool cap
- ② Spool pin
- ③ Thread spool

- 6** Hold the thread from the spool with both hands, and place the thread in the thread guide.

- * Do not place the thread in the pretension disks.

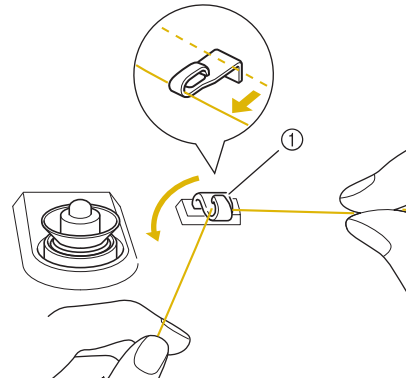

① Thread guide

- 7** While holding the thread from the spool, pull the thread through the lower notch in the thread guide plate, then through the upper notch. Hold the end of the thread with your left hand, and then guide the thread through the groove, following the arrows in the illustration.

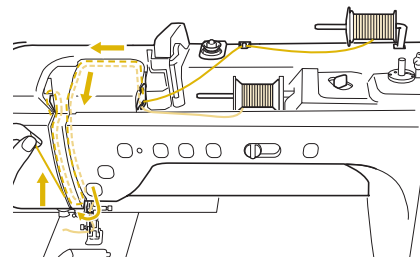

8 Continue threading however do not pass the thread in the needle bar thread guide “6” on the needle bar. Thread the needle on the right side.

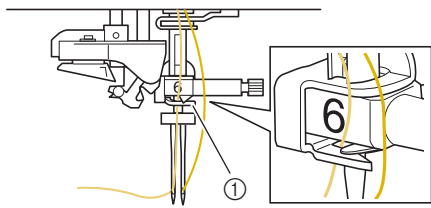

① Needle bar thread guide

9 Press to unlock all keys and buttons.

10 Select a stitch pattern. (Example:)

- * Refer to “Sewing a Stitch” on page 77 for selecting the stitch.
- * Refer to the “STITCH SETTING CHART” on page 206 for the proper stitch to use with presser foot “J”.

→ The selected stitch is displayed.

11 Press , and then press to select the twin needle mode.

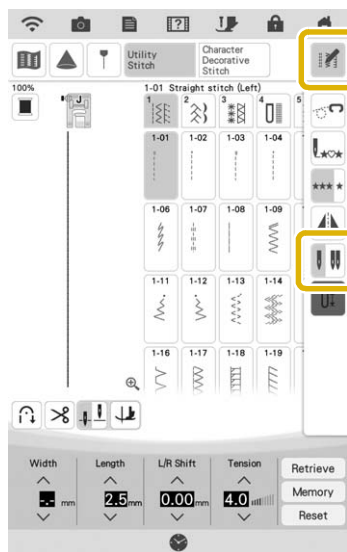

→ Twin needle mode is set.



Note

- If the key is light gray after selecting the stitch, the selected stitch cannot be sewn in the twin needle mode.

CAUTION

- Be sure to set the twin needle mode when using the twin needle. Using the twin needle while the machine is in single needle mode could cause the needle to break, resulting in damage.

12 Start sewing.

Sample of Twin Needle Sewing

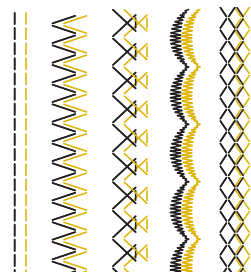

Memo

- To change direction when sewing with the twin needle, raise the needle from the fabric, raise the presser foot lever, and then turn the fabric.

Using the Spool Stand

The included spool stand is useful when using thread on spools with a large diameter (cross-wound thread). This spool stand can hold two spools of thread.



Memo

- Refer to page 24 to assemble the spool stand.
- Refer to page 56 to wind the bobbin when using the spool stand.

Using the Spool Stand

- Be sure to use a spool cap that is slightly larger than the spool. If the spool cap that is used is smaller or much larger than the spool, the thread may catch and sewing performance may suffer.

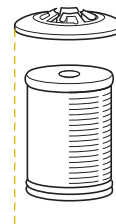

- When using thread on a thin spool, place the included spool felt on the spool pin, place the thread spool on the spool pin so that the center of the spool is aligned with the hole at the center of the spool felt, and then insert the spool cap onto the spool pin.

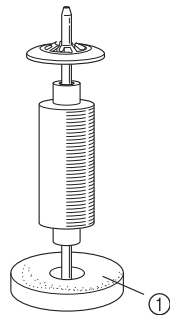

① Spool felt

- When using thread on a cone spool, use the spool holder. When using cone shaped thread spool with other than cotton thread, it is not necessary to use spool caps.

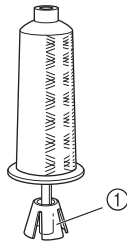

① Spool holder

- Depending on the size of spool or the amount of thread remaining, choose the appropriate sized spool cap (large or medium). Spool cap (small) cannot be used with the spool cap base.

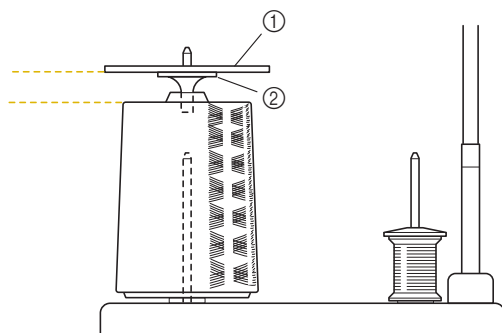

① Spool cap

② Spool cap base

1 Attach the spool stand to the machine.

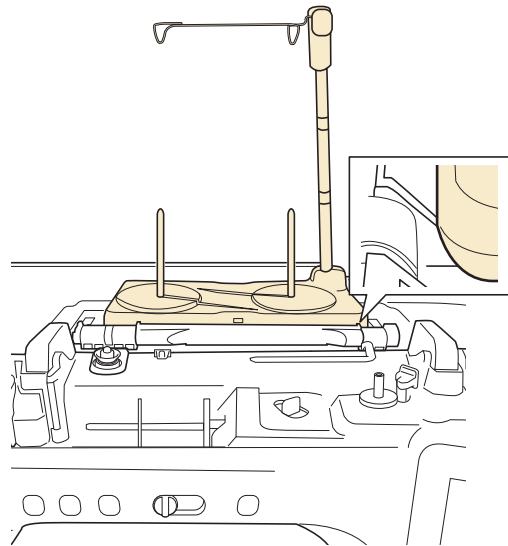

2 Place the spool of thread on the spool pin so that the thread feeds off the spool clockwise. Firmly insert the spool cap onto the spool pin.

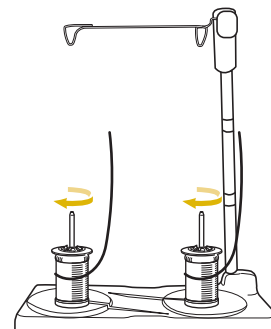

Note

- When using 2 spools of thread, make sure that both spools are feeding in the same direction.
- Make sure that the spools do not touch each other, otherwise the thread will not feed off smoothly, the needle may break, or the thread may break or become tangled. In addition, make sure that the spools do not touch the telescopic thread guide at the center.
- Make sure that the thread is not caught under the spool.

3 Pull the thread off the spool. Pass the thread from the back to the front through the thread guides at the top.

When using thread that quickly feeds off the spool, such as metallic thread, use the enclosed ring to prevent the thread from becoming entangled. Threading sequence; Pull the thread from the spool, place the thread through the ring from the bottom up (1), into the thread guide (2) and through the ring from the top down (3). When using the ring, do not use the spool cap base.

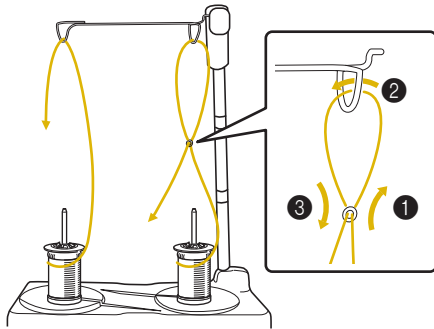

Note

- Guide the thread so that it does not become entangled with the other thread.
- After feeding the thread as instructed, wind any excess thread back onto the spool, otherwise the excess thread will become tangled.

4 Pass the thread through the machine's thread guide from the right to the left.

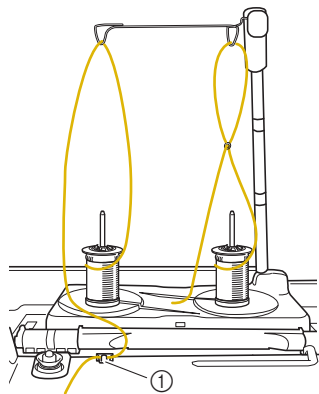

1 Thread guide

5 Thread the machine according to the steps 6 to 15 of "Upper Threading" on page 61.

Using Threads that Unwind Quickly

Using the Spool Net

If using transparent nylon monofilament thread, metallic thread, or other strong thread, place the included spool net over the spool before using it. When using specialty threads, threading must be done manually.

If the spool net is too long, fold it once to match it to the spool size before placing it over the spool.

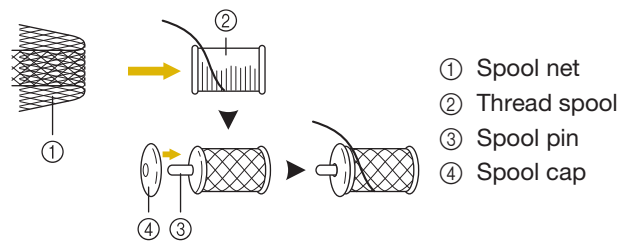



Memo

- When threading the spool with the spool net on, make sure that 50-60 mm (approx. 2 - 2-1/2 inches) of thread are pulled out.
- It may be necessary to adjust the thread tension when using the spool net.

CHANGING THE NEEDLE

⚠ CAUTION

- Always press  on the screen to lock all keys and buttons before changing the needle. If  is not pressed and the “Start/Stop” button or another operation button is pressed accidentally, the machine will start and injury may result.
- Use only home sewing machine needles made for home use. Other needles may bend or break and may cause injury.
- Never sew with a bent needle. A bent needle will easily break and may cause injury.

Memo

- To check the needle correctly, place the flat side of the needle on a flat surface. Check the needle from the top and the sides. Throw away any bent needles.

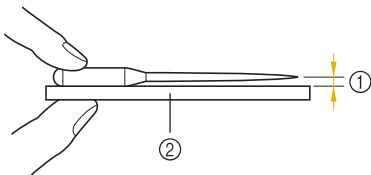

- ① Parallel space
② Level surface (bobbin cover, glass, etc.)

1 Press the “Needle Position” button to raise the needle.

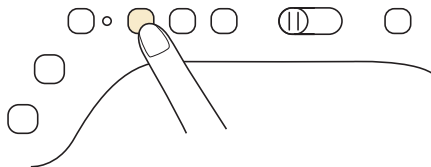

2 Press to lock all keys and buttons.

- * If the message “OK to automatically lower the presser foot?” appears on the LCD screen, press

to continue.

Note

- Before replacing the needle, cover the hole in the needle plate with fabric or paper to prevent the needle from falling into the machine.

3 Use the screwdriver to turn the needle clamp screw toward the front of the machine and loosen the screw. Remove the needle.

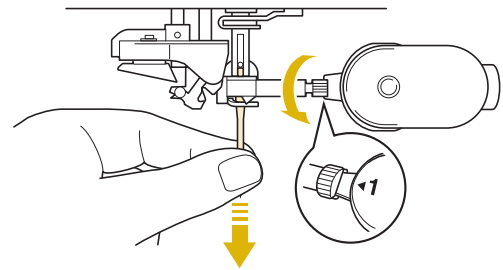

Note

- Do not apply pressure to the needle clamp screw. Doing so may damage the needle or machine.

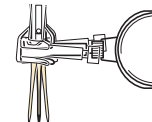

- 4** With the flat side of the needle facing the back, insert the new needle all the way to the top of the needle stopper (viewing window) in the needle clamp. Use a screwdriver to securely tighten the needle clamp screw.

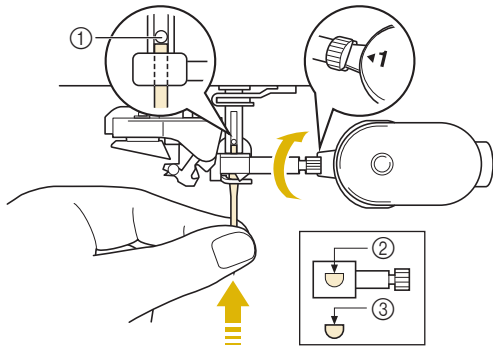

- ① Needle stopper
- ② Hole for setting the needle
- ③ Flat side of needle

⚠ CAUTION

- Be sure to push in the needle until it touches the stopper, and securely tighten the needle clamp screw with a screwdriver. If the needle is not completely inserted or the needle clamp screw is loose, the needle may break or the machine may be damaged.

- 5** Press  to unlock all keys and buttons.

Memo

- The automatic threading function can be used with home sewing machine needle sizes 75/11 through 100/16.
- When threads such as transparent nylon monofilament or speciality threads are used it is not recommended to use the needle threader.

Fabric/Thread/Needle Combinations

- Needles that can be used with this machine: Home sewing machine needles (size 65/9 - 100/16)
* The larger the number, the larger the needle. As the numbers decrease, the needles get finer.
- Thread that can be used with this machine: 30 - 90 weight
* Never use thread of 20 weight or lower. It may cause machine to malfunction.
* The smaller the number, the heavier the thread. As the numbers increase, the thread gets finer.
- The machine needle and thread that should be used depends on the type and thickness of the fabric. Refer to the following table when choosing the thread and needle appropriate for the fabric that you wish to sew.
 - The combinations shown in the table provide a general guideline. Be sure to sew trial stitches on the actual number of layers and type of fabric to be used in your project.
 - The machine needles are consumables. For safety and best results, we recommend replacing the needle regularly. For details on when to replace the needle, refer to "CHANGING THE NEEDLE" on page 69.
- In principle, use a fine needle and thread with lightweight fabrics, and a larger needle and heavier thread with heavyweight fabrics.
- Select a stitch appropriate for the fabric, and then adjust the stitch length. When sewing lightweight fabrics, make the stitch length finer (shorter). When sewing heavyweight fabrics, make the stitch length coarser (longer). (page 86)
When sewing stretch fabrics, refer to "Sewing Stretch Fabrics" on page 84.

Fabric Type/Application		Thread		Size of needle	Stitch length mm (inch)
		Type	Weight		
Lightweight fabrics	Lawn, georgette, challis, organdy, crepe, chiffon, voile, gauze, tulle, lining, etc.	Polyester thread	60 - 90	65/9 - 75/11	Fine stitches 1.8-2.5 (1/16-3/32)
		Cotton thread, Silk thread	50 - 80		
Medium weight fabrics	Broadcloth, taffeta, gabardine, flannel, seersucker, double gauze, linen, terry cloth, waffle weave, sheeting, poplin, cotton twill, satin, quilting cotton, etc.	Polyester thread	60 - 90	75/11 - 90/14	Regular stitches 2.0-3.0 (1/16-1/8)
		Cotton thread, Silk thread	50 - 60		
Heavyweight fabrics	Denim (12 ounces or more), canvas, etc.	Polyester thread, Cotton thread	30	100/16	Coarse stitches 2.5-4.0 (3/32-3/16)
		Polyester thread	60	90/14 - 100/16	
	Cotton thread, Silk thread	30 - 50			
Stretch fabrics (knit fabrics, etc.)	Jersey, tricot, T-shirt fabric, fleece, interlock, etc.	Polyester thread, Cotton thread, Silk thread	50	Ball point needle 75/11 - 90/14	Setting appropriate for the fabric thickness
For top-stitching		Polyester thread, Cotton thread	30	90/14 - 100/16	Setting appropriate for the fabric thickness
			50 - 60	75/11 - 90/14	

■ Transparent nylon thread

Use a home sewing machine topstitching needle, regardless of the fabric or thread.

■ Embroidery needles



Use a 75/11 home sewing machine needle for embroidery.

⚠ CAUTION

- The appropriate fabric, thread and needle combinations are shown in the preceding table. If the combination of the fabric, thread and needle is not correct, particularly when sewing heavy fabrics (such as denim) with thin needles (such as 65/9 to 75/11), the needle may bend or break. In addition, the stitching may be uneven or puckered or there may be skipped stitches.

CHANGING THE PRESSER FOOT



⚠ CAUTION

- Always press  on the screen to lock all keys and buttons before changing the presser foot. If  is not pressed and the “Start/Stop” button or another button is pressed, the machine will start and may cause injury.
- Always use the correct presser foot for the selected stitch pattern. If the wrong presser foot is used, the needle may strike the presser foot and bend or break, and may cause injury.
- Only use presser feet made for this machine. Using other presser feet may lead to accident or injury.

Removing the Presser Foot

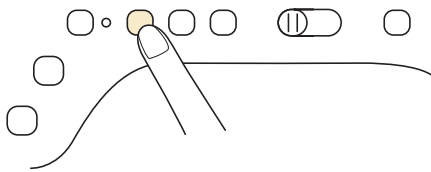
- 1 Press the “Needle Position” button to raise the needle.



- 2 Press  to lock all keys and buttons.
 - * If the message “OK to automatically lower the presser foot?” appears on the LCD screen, press  to continue.

- 3 Raise the presser foot lever.

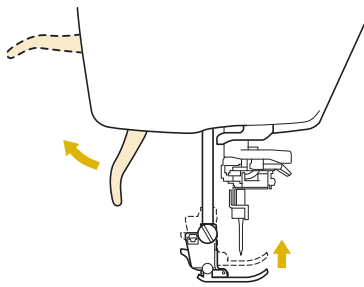

- 4 Press the black button on the presser foot holder and remove the presser foot.

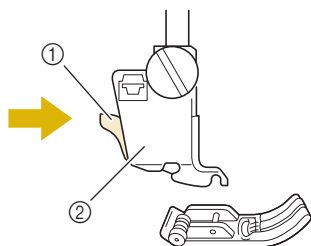

- ① Black button
- ② Presser foot holder

Attaching the Presser Foot

⚠ CAUTION

- Make sure that the presser foot is installed in the correct direction, otherwise the needle may strike the presser foot, breaking the needle and causing injuries.

- 1 Place the new presser foot under the holder, aligning the foot pin with the notch in the holder. Lower the presser foot lever so that the presser foot pin snaps into the notch in the holder.

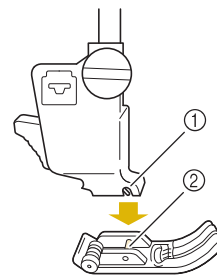

- ① Notch
- ② Pin

- 2 Press  to unlock all keys and buttons.
- 3 Raise the presser foot lever.

Attaching the Presser Foot with the Included Adapter

You can attach the presser feet using the included adapter and small screw.

For example, the walking foot, the free motion echo quilting foot “E”, the free motion quilting foot “C” and so on.

Following procedure shows how to attach the walking foot as an example.

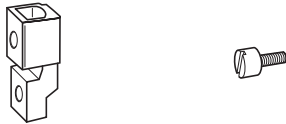

■ Attaching the Walking Foot

The walking foot holds the fabric between the presser foot and the feed dogs to feed the fabric. This enables you to have better fabric control when sewing difficult fabrics (such as quilted fabrics or velvet) or fabrics that slip easily (such as vinyl, leather, or synthetic leather).



Note

- Thread the needle manually when using the walking foot, or only attach the walking foot after threading the needle using the “Automatic Threading” button.
- When sewing with the walking foot, sew at medium to low speeds.



Memo

- The walking foot can only be used with straight or zigzag stitch patterns. Reverse stitches cannot be sewn with the walking foot. Only select straight or zigzag stitch patterns with reinforcement stitches. (page 79.)

1 Follow the steps in “Removing the Presser Foot” on page 72.

2 Loosen the screw of the presser foot holder to remove the presser foot holder.

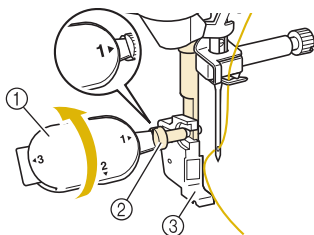

- ① Multi- purpose screwdriver
- ② Presser foot holder screw
- ③ Presser foot holder

3 Remove the screw of the presser foot completely from the presser foot shaft.

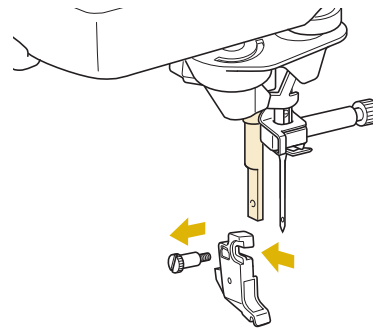

4 Set the adapter on the presser foot bar, aligning the flat side of the adapter opening with the flat side of the presser bar. Push it up as far as possible, and then tighten the screw securely with the screwdriver.

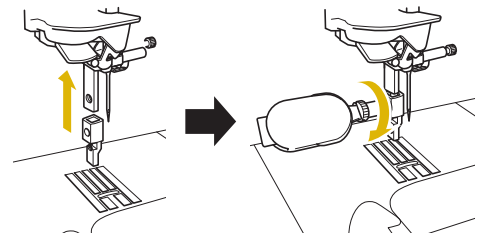

5 Turn a supplied small screw 2 or 3 times with your hand.

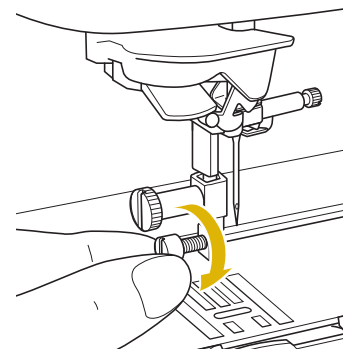

- 6** Set the operation lever of the walking foot so that the needle clamp screw is set in the fork. Position the shank of the walking foot on the presser foot bar.

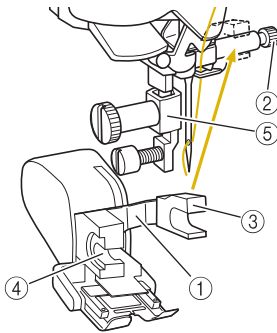

- ① Operation lever
- ② Needle clamp screw
- ③ Fork
- ④ Walking foot shank
- ⑤ Presser foot bar

- 7** Lower the presser foot lever. Insert the screw, and tighten the screw securely with the screwdriver.

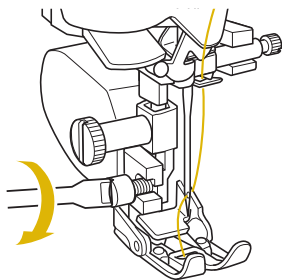

⚠ CAUTION

- Use the included screwdriver to tighten the screw securely. If the screw is loose, the needle may strike the presser foot and cause injury.
- Be sure to rotate the handwheel toward you (counterclockwise) to check that the needle does not strike the presser foot. If the needle strikes the presser foot, injury may result.

Using the Dual Feed Foot

Dual feed foot enables you to have best fabric control when sewing difficult fabrics that slip easily, such as quilted fabrics or fabrics that tend to stick to the bottom of a presser foot, such as vinyl, leather or synthetic leather.



Note

- When sewing with the dual feed foot, sew at medium to low speeds.



Memo

- When selecting stitches to be used with the dual feed foot, only the stitches that can be used will be activated on the display.
- When sewing fabric that easily sticks together, a more attractive finish can be achieved by basting the beginning of sewing.

■ Attaching the Dual Feed Foot

- 1** Follow the steps in “Removing the Presser Foot” on page 72.
- 2** Loosen the screw of the presser foot holder to remove the presser foot holder.

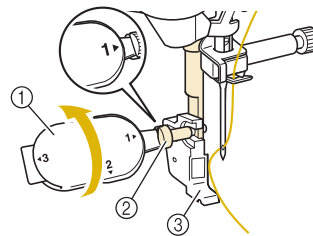

- ① Multi- purpose screwdriver
- ② Presser foot holder screw
- ③ Presser foot holder

- 3** Position the dual feed foot to the presser foot bar by aligning the notch of the dual feed foot to the large screw.

Side view

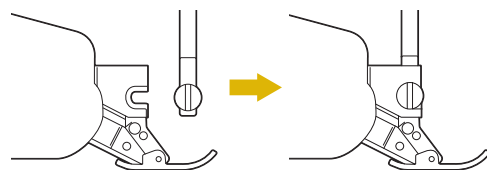

- 4** Hold the dual feed foot in place with your right hand, then using the included screwdriver securely tighten the large screw.

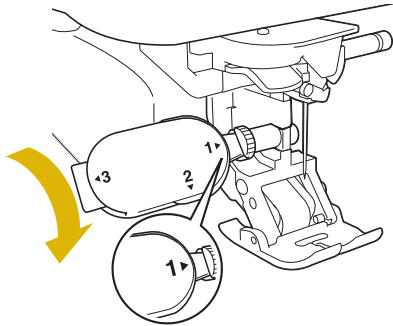

⚠ CAUTION

- Use the included screwdriver to firmly tighten the screw. If the screw is loose, the needle may strike the presser foot and possibly cause injury.

- 5** Plug the connector of the dual feed foot into the jack on the back of your machine.

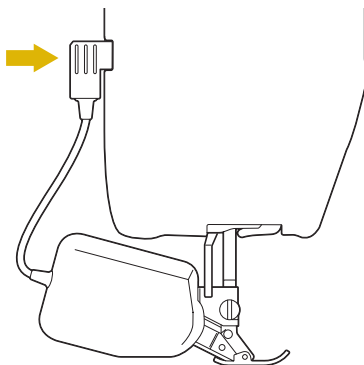

- 6** Press **U** to unlock all keys and buttons.
 → All keys and operation buttons are unlocked, and the previous screen is displayed.

■ Attaching/Detaching toe

Attach the toe by aligning the pins with the notches and snap it into place.

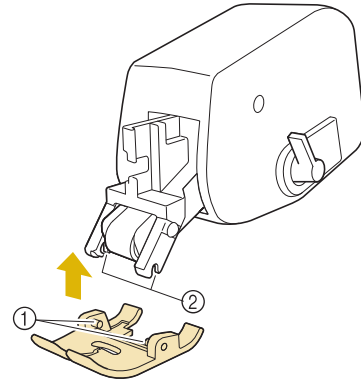

- ① Pins
- ② Notches

If you push down on the front and back part of the dual feed foot, the toe of the dual feed foot will snap off.

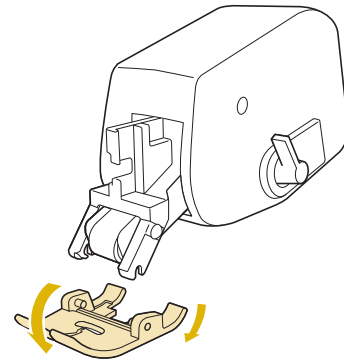

■ Using the Dual Feed Position Lever

When the feed position lever is up, the black roller belt on the dual feed is not engaged.

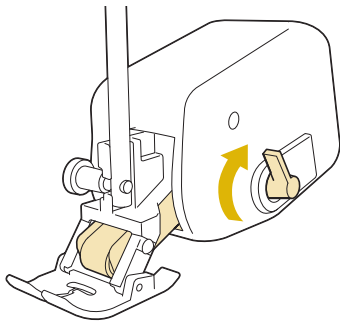

When the feed position lever is down, the black roller belt on the dual feed is engaged.

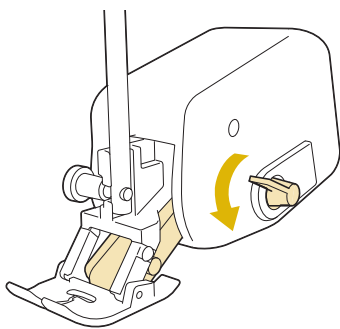

Note

- Do not operate the lever while sewing.

■ Adjusting the Amount of Fabric Feeding of the Dual Feed Foot

The dual feed mechanism pulls the top fabric according to the set stitch length. With troublesome fabrics, fine tune the set length, by changing the dual feed feed adjustment in the settings screen.

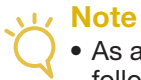

Note

- As a default, some keys mentioned in the following procedures appear in light gray and are not available. To enable the keys for specifying the settings, attach the dual feed foot to the machine. The keys are enabled after the dual feed foot is detected.

1 Press

→ The settings screen appears.

2 Press

→ The Sewing settings screen appears.

3 Display page 2 of the Sewing settings screen.

4 Touch the number to select the feeding of the top fabric.

- * Select "00" for sewing in most cases.
- * If the feed amount for the top fabric is too little, causing the fabric to be longer than the bottom fabric, touch a higher number to increase the feed amount for the top fabric.
- * If the feed amount for the top fabric is too much, causing the fabric to be shorter than the bottom fabric, touch a lower number to decrease the feed amount for the top fabric.

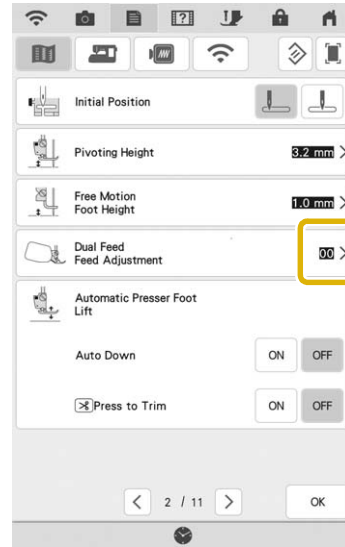

5 Press to return to the original screen.

SEWING

⚠ CAUTION

- To avoid injury, pay special attention to the needle while the machine is in operation. Keep your hands away from moving parts while the machine is in operation.
- Do not stretch or pull the fabric during sewing. Doing so may lead to injury.
- Do not use bent or broken needles. Doing so may lead to injury.
- Do not attempt to sew over basting pins or other objects during sewing. Otherwise, the needle may break and cause injury.
- If stitches become bunched, lengthen the stitch length setting before continuing sewing. Otherwise, the needle may break and cause injury.

2

Sewing Basics

Sewing a Stitch

- 1 Turn the main power to ON and press  to display the utility stitches, and push the “Needle Position” button to raise the needle.
- 2 Select the category, and then press the key of the stitch you want to sew.

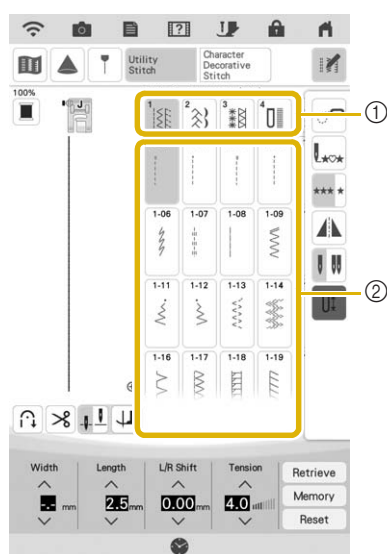

- ① Category
- ② Key of the stitch

→ The symbol of the correct presser foot will be displayed in the upper left corner of the LCD screen.

- 3 Install the presser foot (“CHANGING THE PRESSER FOOT” on page 72).

⚠ CAUTION

- Always use the correct presser foot. If the wrong presser foot is used, the needle may strike the presser foot and bend or break, possibly resulting in injury. Refer to “STITCH SETTING CHART” on page 206 for presser foot recommendations.

- 4 Set the fabric under the presser foot. Hold the fabric and thread in your left hand, and push the “Needle Position” button to set the needle in the sewing start position.

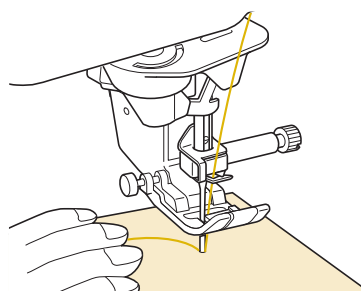

Memo

- The black button on the left side of presser foot “J” should be pressed only if the fabric does not feed or when sewing thick seams (page 83). Normally, you can sew without pressing the black button.

- 5 Lower the presser foot.

* You do not have to pull up the bobbin thread.

6 Adjust the sewing speed with the speed control slide.

* You can use this slide to adjust sewing speed during sewing.

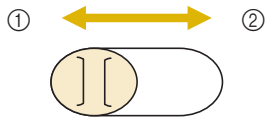

- ① Slow
- ② Fast

7 Press the “Start/Stop” button to start sewing.

* Guide the fabric lightly by hand.

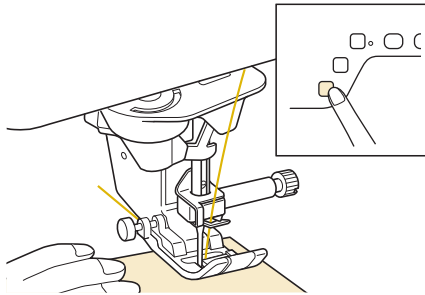

Memo

• When the foot controller is being used, you cannot start sewing by pressing the “Start/Stop” button.

8 Press the “Start/Stop” button again to stop sewing.

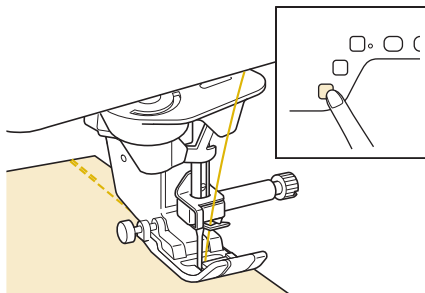

9 Press the “Thread Cutter” button to trim the upper and lower threads.

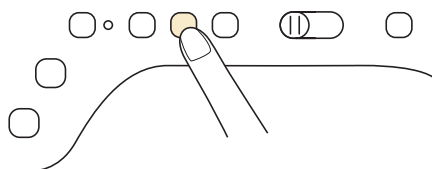

→ The needle will return to the up position automatically.

⚠ CAUTION

- Do not press the “Thread Cutter” button after the threads have been cut. Doing so could tangle the thread or break the needle and damage the machine.
- Do not press the “Thread Cutter” button when there is no fabric set in the machine or during machine operation. The thread may tangle, possibly resulting in damage.

Note

• When cutting thread thicker than #30, nylon monofilament thread, or other decorative threads, use the thread cutter on the side of the machine.

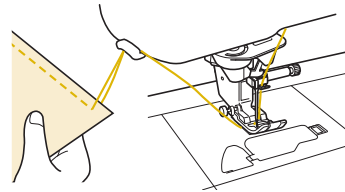

10 When the needle has stopped moving, raise the presser foot and remove the fabric.

Memo

• This machine is equipped with a bobbin thread sensor that warns you when the bobbin thread is almost empty. When the bobbin thread is nearly empty, the machine automatically stops. However, if the “Start/Stop” button is pressed, a few stitches can be sewn. When the warning displays, re-thread the machine immediately.

■ Using the Foot Controller

You can also use the foot controller to start and stop sewing.

⚠ CAUTION

- Do not allow fabric pieces and dust to collect in the foot controller. Doing so could cause a fire or an electric shock.

Memo

- When the foot controller is being used, you cannot start sewing by pressing the “Start/Stop” button.
- The foot controller cannot be used when embroidering.
- The foot controller can be used for sewing utility and decorative stitches when the embroidery unit is attached.

1 Insert the foot controller plug into its jack on the machine.

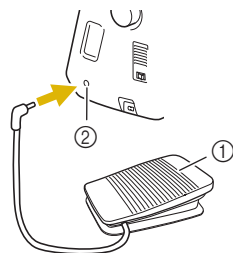

- ① Foot controller
- ② Foot controller jack

2 Slowly depress the foot controller to start sewing.

Pressing down on the foot controller increases the sewing speed; releasing the pressure on the foot controller decreases the sewing speed.

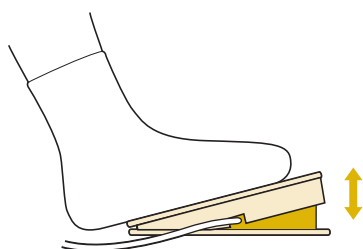

Memo

- The speed that is set using the sewing speed controller is the foot controller's maximum sewing speed.

3 Release the foot controller to stop the machine.

Sewing Reinforcement Stitches

Reverse/reinforcement stitches are generally necessary at the beginning and end of sewing. You can use the "Reverse Stitch" button to sew reverse/reinforcement stitches. When you keep pressing "Reinforcement Stitch" button, the machine will sew reinforcement stitch at that point 3 to 5 stitches, and then stop. (page 15)

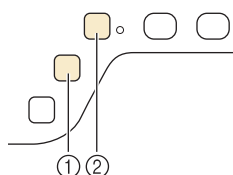

- ① "Reverse Stitch" button
- ② "Reinforcement Stitch" button

If the automatic reinforcement stitch is selected on the screen, reverse stitches (or reinforcement stitches) will be sewn automatically at the beginning of sewing when the "Start/Stop" button is pressed. Press "Reverse Stitch" button or "Reinforcement Stitch" button to sew reverse stitches (or reinforcement stitches) automatically at the end of sewing (Refer to the next procedure "Automatic Reinforcement Stitching".).

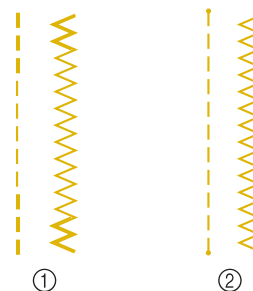

- ① Reverse stitch
- ② Reinforcement stitch

The operation performed when the button is pressed differs depending on the selected stitch pattern. (Refer to "STITCH SETTING CHART" on page 206.)

Memo

- When you press the "Reinforcement Stitch" button while sewing character/decorative stitch pattern, you can end sewing with a full stitch instead of at a mid-point.
- The green light on the right of the "Reinforcement Stitch" button lights up while the machine is sewing a full motif, and it automatically turns off when the sewing is stopped.

Automatic Reinforcement Stitching

After selecting a stitch motif, turn on the automatic reinforcement stitching function before sewing, and the machine will automatically sew reinforcement stitches (or reverse stitches, depending on the stitch motif) at the beginning and end of sewing.

- 1 Select a stitch pattern.
- 2 Press  to set the automatic reinforcement stitching function.

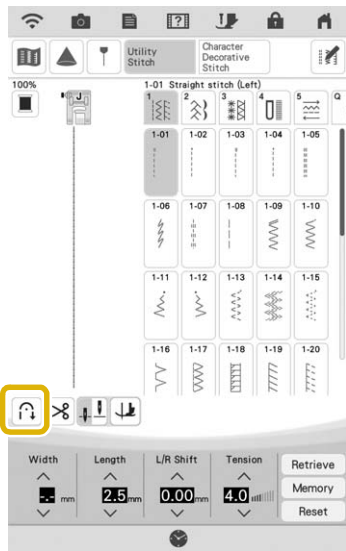

→ The key will display as .

Memo

- Some stitches, such as buttonholes and bar tacks, require reinforcement stitches at the beginning of sewing. If you select one of these stitches, the machine will automatically turn on this function (the key appears as  when the stitch is selected).

- 3 Set the fabric in the start position and begin sewing.

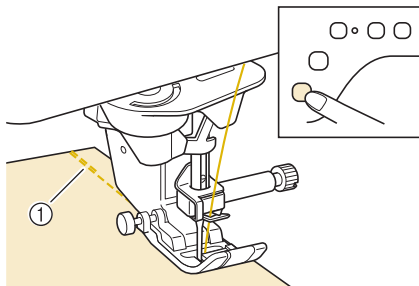

- 1 Reverse stitches (or reinforcement stitches)
→ The machine will automatically sew reverse stitches (or reinforcement stitches) and then continue sewing.

If you press the Start/Stop button to pause sewing, press it again to continue. The machine will not sew reverse/reinforcement stitches again.

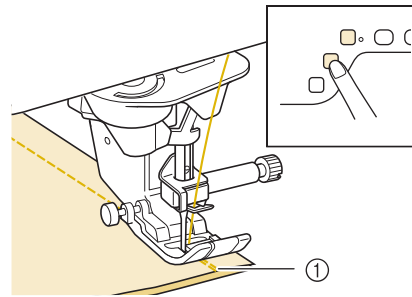

- 4 Press “Reverse Stitch” button or “Reinforcement Stitch” button.





- 1 Reverse stitches (or reinforcement stitches)
→ The machine will sew reverse stitches (or reinforcement stitches) and stop.







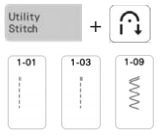
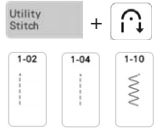
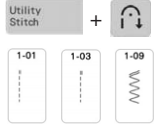
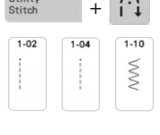

Memo

- To turn off the automatic reinforcement stitching function, press  again, so it appears as .

The operation performed when the button is pressed differs depending on the selected stitch pattern. Refer to the following table for details on the operation that is performed when the button is pressed.

	“Reverse Stitch” button 	“Reinforcement Stitch” button 
	Machine starts sewing the stitches and only sews reverse stitches while holding the “Reverse Stitch” button.	Machine starts sewing the stitches and sews 3 – 5 reinforcement stitches while holding the “Reinforcement Stitch” button.
	Machine starts sewing the stitches and only sews reverse stitches while holding the “Reverse Stitch” button.*	Machine starts sewing the stitches and sews 3 – 5 reinforcement stitches while holding the “Reinforcement Stitch” button.
	Machine sews reverse stitches at the beginning and end of sewing.	Machine sews reverse stitches at the beginning and reinforcement stitches at the end of sewing.
	Machine sews reinforcement stitches at the beginning and reverse stitches at the end of sewing.*	Machine sews reinforcement stitches at the beginning and end of sewing.

	“Reverse Stitch” button 	“Reinforcement Stitch” button 
 + 	Machine starts sewing and then sews reinforcement stitches while holding the “Reverse Stitch” button.	Machine starts sewing at the beginning, then completes the stitch pattern and sews reinforcement stitches at the end of sewing.
 + 	Machine sews reinforcement stitches at the beginning and sews reinforcement stitches when the “Reverse Stitch” button is pressed.	Machine sews reinforcement stitches at the beginning, then completes the stitch pattern and sews reinforcement stitches at the end of sewing.

* If “Reinforcement Priority” of the settings screen is set to “ON” (page 29), reinforcement stitches are sewn instead of reverse stitches.

Automatic Presser Foot Lowering Function and Thread Cutting Function

By setting the machine to automatically raise and lower the presser foot, sewing operations can be performed more smoothly.

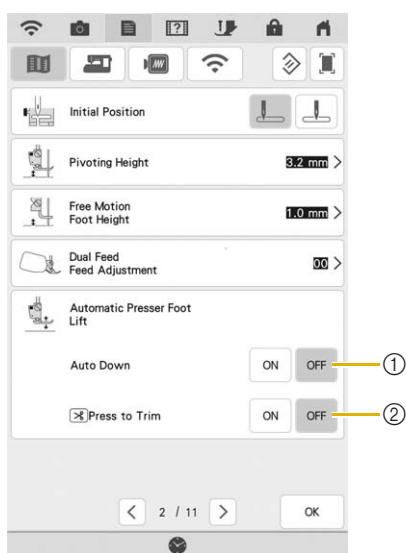

No.	Key Name	Explanation
①	Auto Down	When “Auto Down” in the machine settings screen is set to “ON”, pressing the “Start/Stop” button or depressing the foot controller automatically lowers the presser foot (if it is raised) before starting to sew.

No.	Key Name	Explanation
②	Press to Trim	When “Press to Trim” in the machine settings screen is set to “ON”, pressing the “Thread Cutter” button automatically lowers the presser foot (if it is raised) before cutting the thread. The presser foot will be raised after the thread is cut.

Sewing Curves

Sew slowly while keeping the seam parallel with the fabric edge as you guide the fabric around the curve.

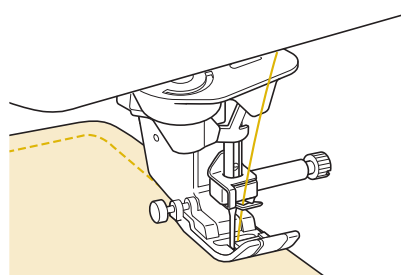

Changing Sewing Direction

Stop the machine. Leave the needle in the fabric, and press the “Presser Foot Lifter” button to raise the presser foot. Using the needle as a pivot, turn the fabric so that you can sew in the new direction. Press the “Presser Foot Lifter” button to lower the presser foot and start sewing.

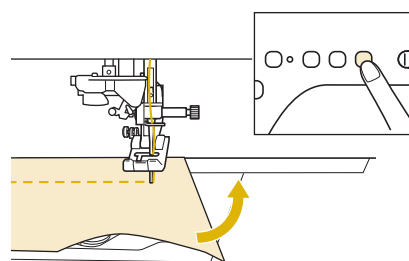

The pivot setting is useful when changing the sewing direction. When the machine is stopped at the corner of the fabric, the machine stops with the needle in the fabric and the presser foot is automatically raised so the fabric can easily be rotated (“Pivoting” on page 89).

■ Sewing a Seam Allowance of 0.5 cm or Less

Baste the corner before sewing, and then, after changing the sewing direction at the corner, pull the basting thread toward the back while sewing.

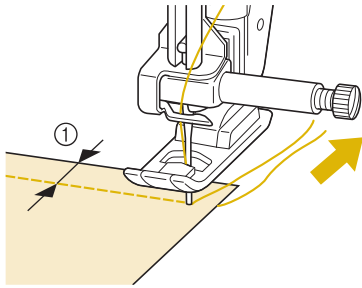

① 5 mm (approx. 3/16 inch)

Sewing Heavyweight Fabrics

The machine can sew fabrics up to 6 mm (approx. 1/4 inch) thick. If the thickness of a seam causes sewing to occur at an angle, help guide the fabric by hand and sew on the downward slope.

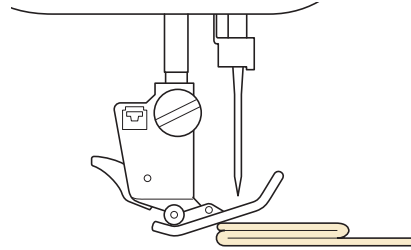

⚠ CAUTION

- Do not forcefully push fabrics more than 6 mm (approx. 1/4 inch) thick through the machine. This may cause the needle to break and cause injury.
- Thicker fabrics require a larger needle. (page 71)

■ If the Fabric does not Fit under the Presser Foot

If the presser foot is in the up position, and you are sewing heavyweight or multiple layers of fabric which do not fit easily under the presser foot, use the presser foot lever to raise the presser foot to its highest position. The fabric will now fit under the presser foot.

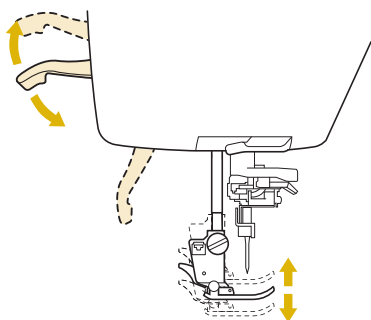

Memo

- You cannot use the presser foot lever after the presser foot has been raised using the “Presser Foot Lifter” button.

■ If the Fabric does not Feed

If the fabric does not feed when starting to sew or when sewing thick seams, press the black button on the left side of presser foot “J”.

1 Raise the presser foot.

2 While keeping the black button on the left side of presser foot “J” pressed in, press the “Presser Foot Lifter” button to lower the presser foot.

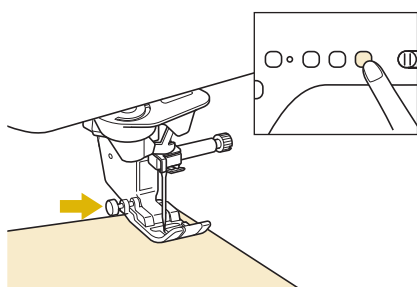

3 Release the black button.

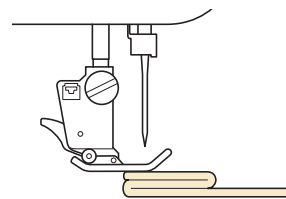

→ The presser foot remains level, enabling the fabric to be fed.

Memo

- Once the trouble spot has been passed, the foot will return to its normal position.
- When “Automatic Fabric Sensor System” (Automatic Presser Foot Pressure) in the machine settings screen is set to “ON”, the thickness of the fabric is automatically detected by the internal sensor so the fabric can be fed smoothly for best sewing results. (page 91.)

Sewing Hook-and-Loop Fastener Tape

CAUTION

- Do not use adhesive backed hook-and-loop fastener tape designed for sewing. When glue adheres to the needle or the bobbin hook race, it may cause malfunction.
- If the hook-and-loop fastener tape is sewn with a fine needle (65/9-75/11), the needle may bend or break.

Note

- Before starting to sew, baste the fabric and hook-and-loop fastener tape together.

Make sure that the needle passes through the hook-and-loop fastener tape by rotating the handwheel and lower the needle into the hook-and-loop fastener tape before sewing. Sew the edge of the hook-and-loop fastener tape at a slow speed.

If the needle does not pass through the hook-and-loop fastener tape, replace the needle size with the needle for thick fabrics (page 71).

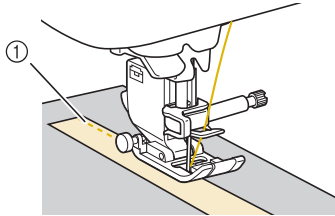

① Edge of the hook-and-loop fastener tape

Sewing Lightweight Fabrics

Place thin paper or tear away embroidery stabilizer under thin fabrics to make sewing easier. Gently tear off the paper or the stabilizer after sewing.

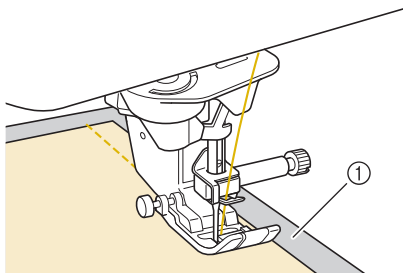

① Thin paper

Sewing Stretch Fabrics

First, baste together the pieces of fabric, and then sew without stretching the fabric.

In addition, a better result can be achieved by using thread for knits or a stretch stitch.



Memo

- For best results when sewing stretch fabrics, decrease the pressure of the presser foot (“Using the Machine Setting Mode Key” on page 28).

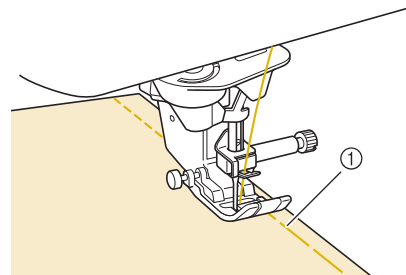

① Basting stitching

STITCH SETTINGS

When you select a stitch, your machine automatically selects the appropriate stitch width, stitch length, and upper thread tension. However, if needed, you can change any of the individual settings.

Note

- Settings for some stitches cannot be changed (refer to “STITCH SETTING CHART” on page 206).
- If you turn off the machine or select another stitch without saving stitch setting changes (“Saving Your Stitch Settings” on page 107), the stitch settings will return to their default settings.

Setting the Stitch Width

Follow the steps below when you want to change the zigzag stitch pattern width.



Memo

- For an alternate method of changing the stitch width using the speed controller, refer to page 125.

Example:

Press to narrow the zigzag stitch pattern width.

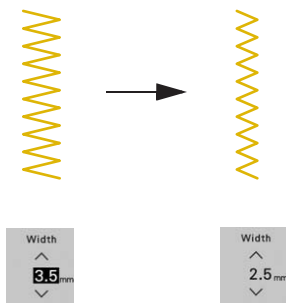

→ The value in the display gets smaller.

Press to widen the zigzag stitch pattern width.

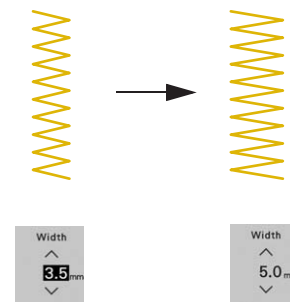

→ The value in the display gets bigger.

Memo

- Press to save the stitch settings.
- Press to check changes made to the stitch.
- Press to return the stitch width to the original setting.

Note

- After adjusting the stitch width, slowly rotate the handwheel toward you (counterclockwise) and check that the needle does not touch the presser foot. If the needle hits the presser foot, the needle may bend or break.

Setting the Stitch Length

Follow the steps below when you want to change the stitch pattern length.



Example:

Press to shorten the stitch length.

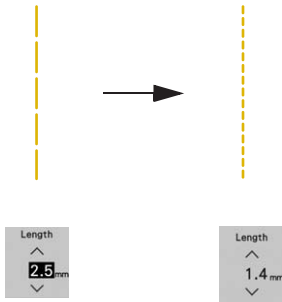

→ The value in the display gets smaller.

Press to lengthen the stitch length.

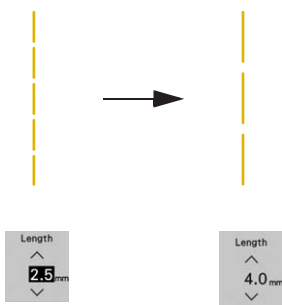

→ The value in the display gets bigger.

Memo

- Press to save the stitch settings.
- Press to check changes made to the stitch.
- Press to return the stitch length to the original setting.

CAUTION

- If the stitches get bunched together, lengthen the stitch length and continue sewing. Do not continue sewing without lengthening the stitch length. Otherwise, the needle may break and cause injury.

Setting the “L/R Shift”

Follow the steps below when you want to change the placement of the zigzag stitch pattern by moving it left and right.



Example:

Press to shift the stitch pattern to the left.

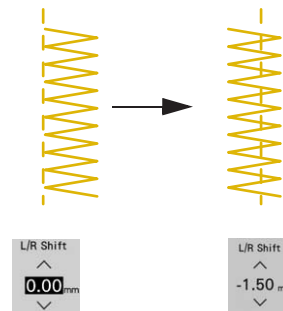

→ The value in the display appears with a minus sign.

Press to shift the stitch pattern to the right side of the left needle position.

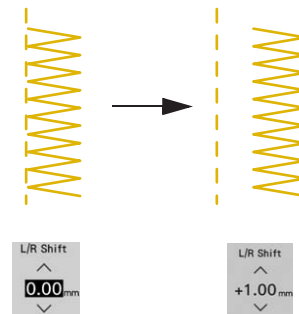

→ The value in the display appears with a plus sign.

Memo

- Press to save the stitch settings.
- Press to check changes made to the stitch.
- Press to return to the original setting.

Note

- After adjusting the “L/R Shift”, slowly rotate the handwheel toward you (counterclockwise) and check that the needle does not touch the presser foot. If the needle hits the presser foot, the needle may bend or break.

Setting the Thread Tension

You may need to change the thread tension, depending on the fabric and thread being used. Follow the steps below to make any necessary changes.



■ Proper Thread Tension

The upper thread and the bobbin thread should cross near the center of the fabric. Only the upper thread should be visible from the right side of the fabric, and only the bobbin thread should be visible from the wrong side of the fabric.

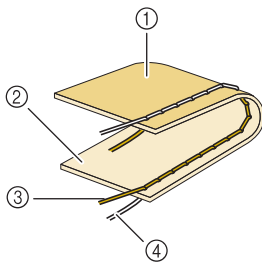

- ① Wrong side
- ② Surface
- ③ Upper thread
- ④ Bobbin thread

■ Upper Thread is Too Tight

If the bobbin thread is visible from the right side of the fabric, the upper thread is too tight.



- Note**
- If the bobbin thread was incorrectly threaded, the upper thread may be too tight. In this case, refer to “Setting the Bobbin” on page 58 and rethread the bobbin thread.

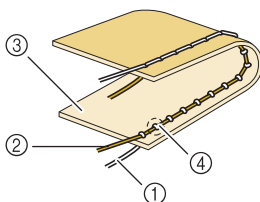

- ① Bobbin thread
- ② Upper thread
- ③ Surface
- ④ Locks appear on surface of fabric

Press to loosen the upper thread.

Memo

- When you finish sewing, remove the bobbin cover and then make sure that the thread is shown as below. If the thread is not shown as below, the thread is not inserted through the tension-adjusting spring of the bobbin case correctly. Reinsert the thread correctly. For details, refer to page 58.

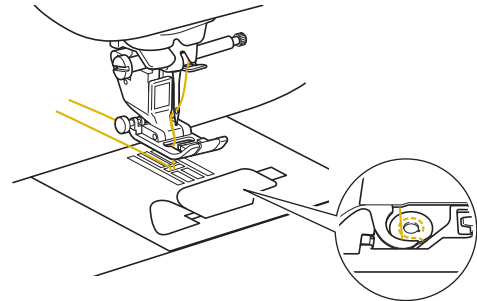

■ Upper Thread is Too Loose

If the upper thread is visible from the wrong side of the fabric, the upper thread is too loose.



- Note**
- If the upper thread was incorrectly threaded, the upper thread may be too loose. In this case, refer to “Upper Threading” on page 61 and rethread the upper thread.

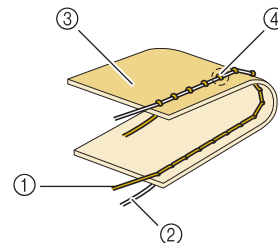

- ① Upper thread
- ② Bobbin thread
- ③ Wrong side
- ④ Locks appear on wrong side of fabric

Press to tighten the upper thread.

Memo

- Press to return the thread tension to the original setting.

USEFUL FUNCTIONS



Automatic Thread Cutting

After selecting a stitch pattern, turn on the automatic thread cutting function before sewing, and the machine will automatically sew reinforcement stitches (or reverse stitches, depending on the stitch pattern) at the beginning and end of sewing, and trim the threads at the end of sewing. This function is useful when sewing buttonholes and bar tacks.

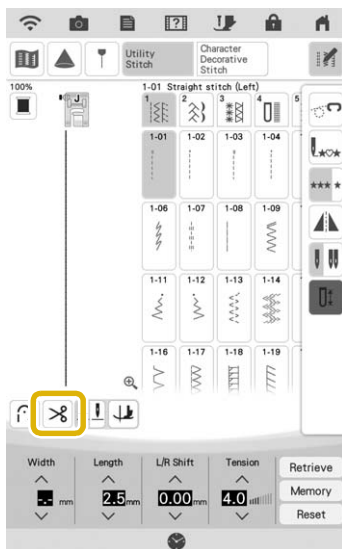

1 Select a stitch pattern.

2 Press  to set the automatic thread cutting function.



→ You get  , and the machine is set for automatic thread cutting function and automatic reverse/reinforcement stitching.

Memo

- To turn off the automatic thread cutting function, press  again, so it appears as .
- This function is set automatically when doing embroidery.

3 Set the fabric in the start position and start sewing.

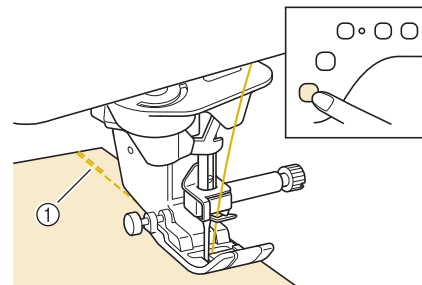

- ① Reverse stitches (or reinforcement stitches)
→ The machine will automatically sew reverse stitches (or reinforcement stitches) and then continue sewing.

Memo

- If you press the “Start/Stop” button to pause sewing, press the same button again to continue. The beginning reverse/reinforcement stitches will not be sewn again.

4 Once you have reached the end of the stitching, press “Reverse Stitch” button or “Reinforcement Stitch” button once.

If stitching, such as buttonholes and bar tacking, that includes reinforcement stitching has been selected, this operation is unnecessary.



- ① The point where the “Start/Stop” button was pressed.
- ② The point where the “Reverse Stitch” button or the “Reinforcement Stitch” button was pressed.
- ③ The thread is cut here.

Memo

- The automatic thread cutting function will not be performed if the “Start/Stop” button is pressed while sewing. Press the “Reverse Stitch” button or the “Reinforcement Stitch” button at the end of the stitching.

Pivoting

If the pivot function is selected, the machine stops with the needle lowered (in the fabric) and the presser foot is automatically raised to an appropriate height when the “Start/Stop” button is pressed. When the “Start/Stop” button is pressed again, the presser foot is automatically lowered and sewing continues. This function is useful for stopping the machine to rotate the fabric.

⚠ CAUTION

- When the pivot setting is selected, the machine starts when the “Start/Stop” button is pressed or the foot controller is pressed down even if the presser foot has been raised. Be sure to keep your hands and other items away from the needle, otherwise injuries may occur.

📖 Memo

- When the pivot setting is selected, the height of the presser foot when sewing is stopped can be changed according to the type of fabric being sewn. Press  to display “Pivoting Height” of the settings screen. Touch the number to select the height. To raise the presser foot further, increase the setting. (Normally, 3.2 mm is set.)

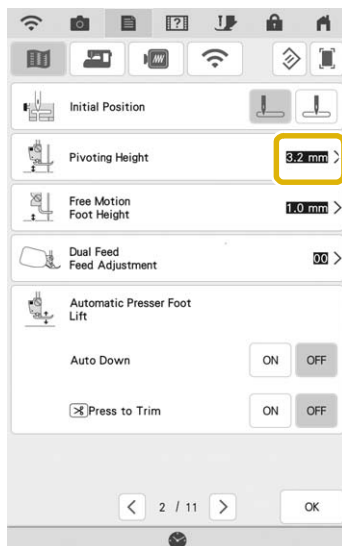

💡 Note

- The pivot function can only be used with stitches where presser foot “J”, “N” or “X” (Couching foot) is indicated in the upper-left corner of the screen. If any other stitch is selected,  appears as light gray and is not available.
- If the pivot function is selected, “Presser Foot Height” in the settings screen are not available and the setting cannot be changed.

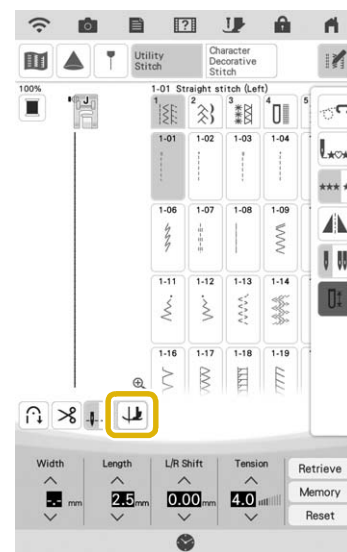

1 Select a stitch.

2 Press to select the pivot setting.



→ The key appears as .

💡 Note

- To use the pivot function, the needle position should be set to . When the needle position is set to , the presser foot is raised automatically.

3 Place the fabric under the presser foot with the needle at the starting point of the stitching, and then press the “Start/Stop” button. The machine will begin sewing.

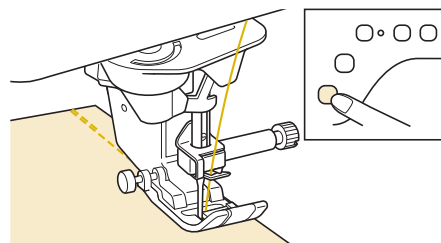

Memo

- If you press the “Start/Stop” button to pause sewing, press it again to continue, reverse stitches (or reinforcement stitches) will not be sewn.

4 Press the “Start/Stop” button to stop the machine at the point where the sewing direction changes.

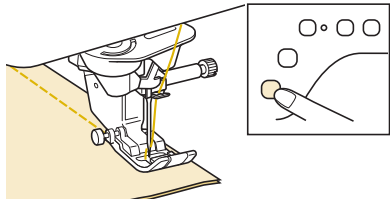

→ The machine stops with the needle in the fabric, and the presser foot is raised.

Memo

- If “Automatic Presser Foot Lift” in the machine settings screen is set to “ON”, the needle and the presser foot are raised when the machine is stopped.

5 Rotate the fabric, and then press the “Start/Stop” button.

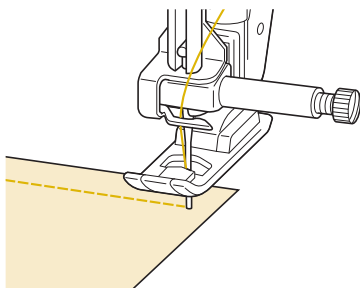

→ The presser foot is automatically lowered, and sewing continues.

Using the Knee Lifter

Using the knee lifter, you can raise and lower the presser foot with your knee, leaving both hands free to handle the fabric.

1 Change the operating position of the knee lifter handle before inserting into the machine.

Slide up the knee lifter handle slightly and rotate it while releasing pressure so handle will click into position.

- * The knee lifter can be adjusted to three different angles.

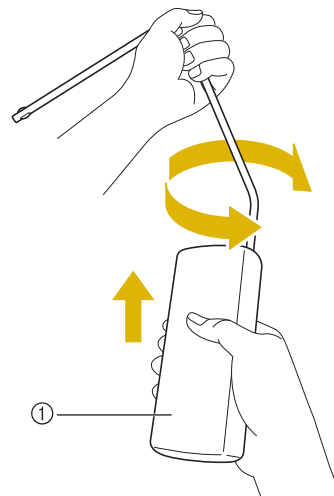

① Knee lifter handle

→ Rotate knee lifter handle till it clicks into the selected position that is most comfortable for you.

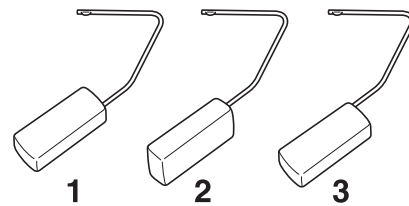

- 2** Align the tabs on the knee lifter with the notches in the knee lifter slot on the front of the machine. Insert the knee lifter bar as far as possible.

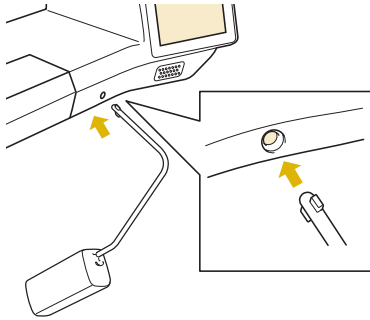

⚠ CAUTION

- Only change position of the knee lifter handle when knee lifter is not on the machine, otherwise the knee lifter may damage the mounting slot on front of the machine.



Note

- If the knee lifter bar is not pushed into the mounting slot as far as possible, it may come out during use.

- 3** Use your knee to move the knee lifter bar to the right in order to raise the presser foot. Release the knee lifter to lower the presser foot.

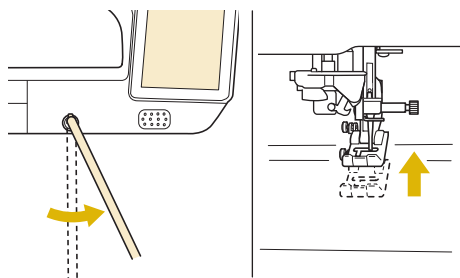

⚠ CAUTION

- Be sure to keep your knee away from the knee lifter during sewing. If the knee lifter is pushed during machine operation, the needle may break or the thread tension may loosen.



Memo

- When the presser foot is in the up position, move the knee lifter to the far right and then release to return the presser foot to the down position.

Automatic Fabric Sensor System (Automatic Presser Foot Pressure)

The thickness of the fabric is automatically detected and the presser foot pressure is automatically adjusted with an internal sensor while sewing, to insure that your fabric is fed smoothly. The fabric sensor system works continuously while sewing. This function is useful for sewing over thick seams (page 82), or quilting (page 123).

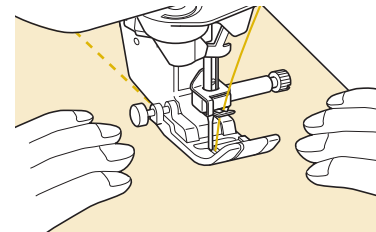
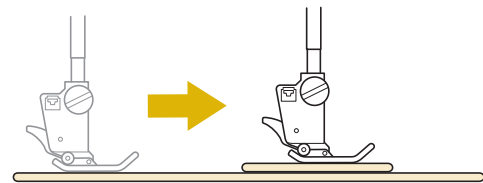

- 1** Press .

→ The settings screen appears.

- 2** Set “Automatic Fabric Sensor System” to “ON”.

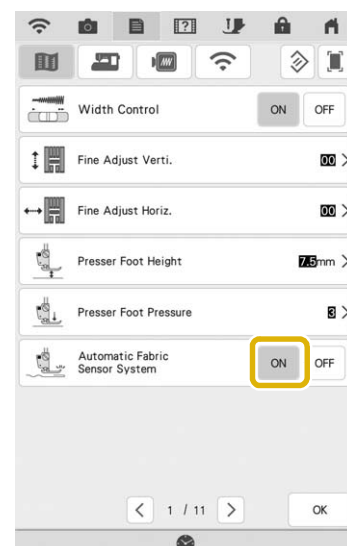

- 3** Press  to return to the original screen.

Needle Position - Stitch Placement

When the "Needle Position - Stitch Placement" is "ON", the needle will be partially lowered for precise stitch placement and then press the "Needle Position" button to lower the needle completely. Each press of the "Needle Position" button changes the needle to the next position. When the "Needle Position - Stitch Placement" is "OFF", each press of the "Needle Position" button simply raises and then lowers the needle.

"Needle Position - Stitch Placement" is "ON"

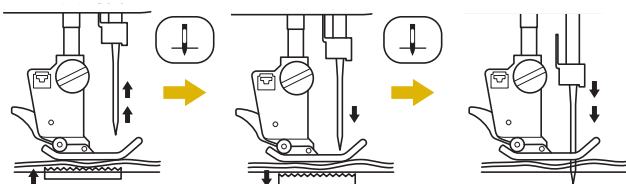

* When the needle is nearly lowered by pressing the "Needle Position" button, the feed dogs are lowered. At this time, the fabric can be shifted to finely adjust the needle drop position.

"Needle Position - Stitch Placement" is "OFF"

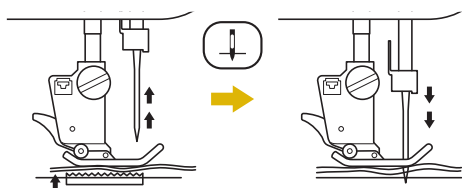

1 Press .

2 Set "Needle Position - Stitch Placement" to "ON" or "OFF".

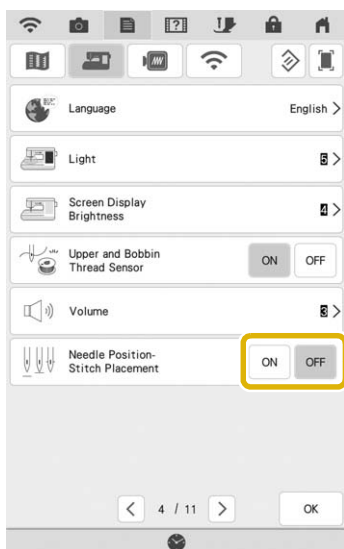

3 Press  to return to the original screen.

Checking the Needle Location in the Screen

You can check the stitch image with actual fabric image on the screen.

1 Select a stitch.

2 Press .

→ An image of the selected stitch and the actual fabric image are displayed.

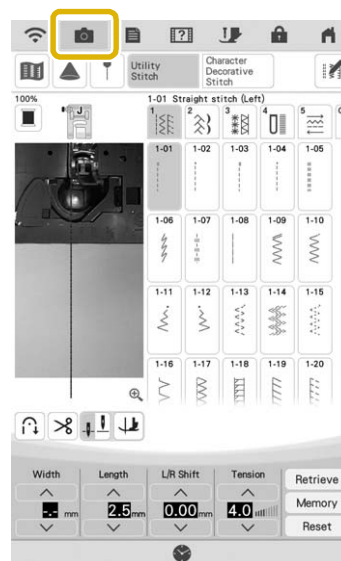

* Press  to change the thread color displayed on the screen. You can select from four different colors.

3 Press on the fabric image or  on the screen.

→ The camera view window appears.

→ Press  again to turn off the camera view.

■ Using the Camera View Window

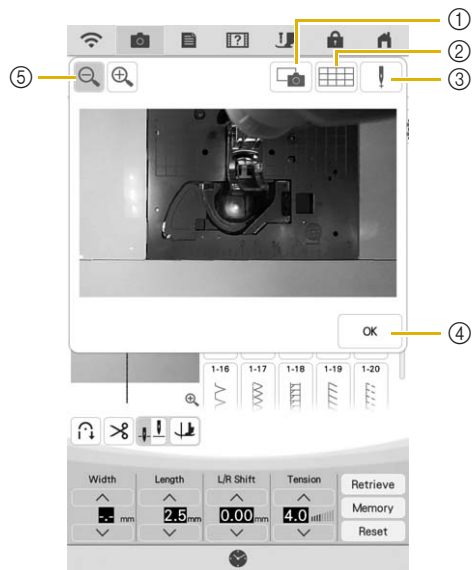

→ The camera view window appears.

- ① CAMERA IMAGE
- ② GRID VIEW
- ③ NEEDLE DROP POSITION
- ④ OK
- ⑤ ZOOM

CAMERA IMAGE

Press this key to save a camera image to the USB media.

Insert the USB media to the machine to save a camera image (Refer to “Saving a Settings Screen Image to USB Media” on page 32). The files for camera images are saved as “.PNG”. A maximum of 100 camera images can be saved in one USB media.

GRID VIEW

Press this key to display a grid.

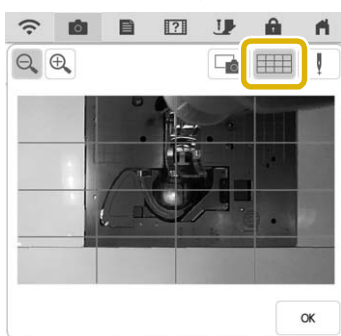

Press to close the screen.

NEEDLE DROP POSITION

Press to show the needle drop position in the screen as “+”.

Lower the presser foot before pressing . Once the needle drop position appears on the screen, you can raise the presser foot and change the needle drop position by moving the fabric.

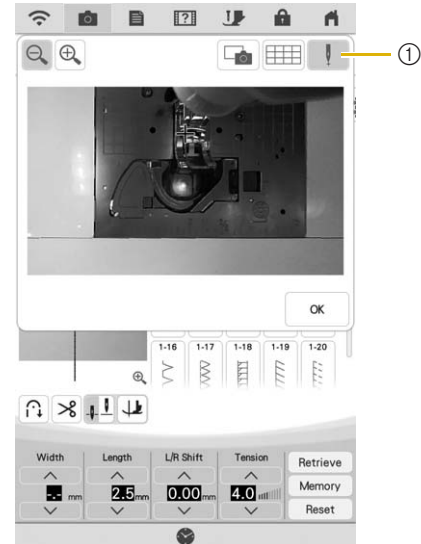

- ① Needle drop position

ZOOM

Press to enlarge the image in the screen.

Press again to return the image to its original display size.



Note

- The camera view window disappears when you start sewing.
- When sewing thick fabrics, the needle drop position indicated in the screen may differ from the actual position.

USING THE PROJECTOR

Convenient Sewing Features by Using the Projector

Operations that can use the projector

- Setting the guideline as a reference for your sewing position.
- Selecting a stitch pattern
- Editing the selected stitch pattern
- Displaying the needle drop point (when embroidering)
- Displaying the edited embroidery pattern (when embroidering)

⚠ CAUTION

- Do not stare directly at the projector light. Otherwise, blindness may result.

About the Dual Purpose Stylus

The included dual purpose stylus has two points. Use the soft point to operate the LCD screen and the hard point to operate the projector.

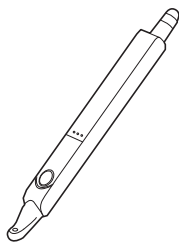

Installing a Battery in the Dual Purpose Stylus

A battery for the dual purpose stylus is not included with your machine. Use a new AAA alkaline battery (LR03).

⚠ WARNING

- Do not disassemble or modify the dual purpose stylus.
- Do not use metallic objects, such as tweezers or a metallic pen, when changing the battery.
- Do not throw the battery into fire or expose to heat.
- Remove battery immediately and stop using the machine if you notice abnormal odor, heat, discoloration, deformation or anything unusual while using or storing it.

⚠ CAUTION

- Remove the battery if you do not intend to use the dual purpose stylus for an extended period of time.
- Do not set the positive and negative ends of the battery in the wrong direction.

- 1 Slide the lid with your finger to remove it.

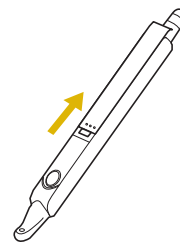

- 2 Install a new AAA alkaline battery (LR03) in the dual purpose stylus with the negative end (-) pointing up.

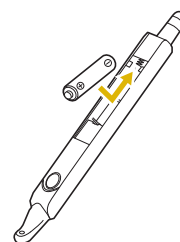

3 Close the lid.

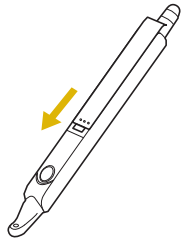

Operating the Projector with the Dual Purpose Stylus

Press the button to light the hard point of the dual purpose stylus. After the built-in camera detects the light, you can operate the projector with the dual purpose stylus.

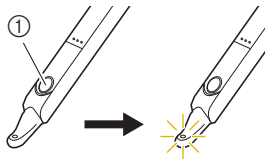

① Button

⚠ IMPORTANT

- Do not put your hand, fabric or any object between the built-in camera and the light-emitting part of the dual purpose stylus, otherwise the built-in camera cannot detect the light from the dual purpose stylus.

⚠ CAUTION

- Do not insert any object into the light-emitting part of the dual purpose stylus, otherwise the stylus may be damaged.

Using the Dual Purpose Stylus Holder

Attach the dual purpose stylus holder to keep the dual purpose stylus with the machine. The right side of the holder can be used to hold the dual purpose stylus.

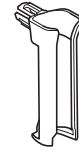

Dual purpose stylus holder

1 Firmly insert the dual purpose stylus holder into the hole.

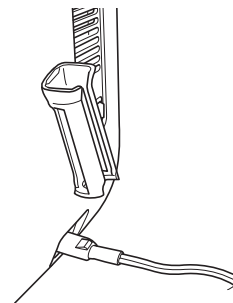
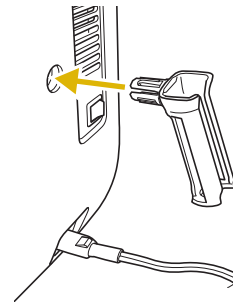

2 With the flat part of the dual purpose stylus facing to the machine, insert it into the dual purpose stylus holder.

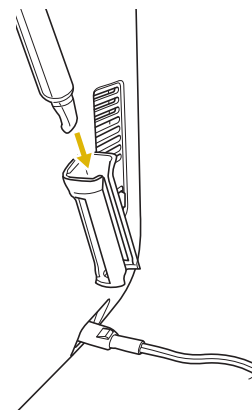

PROJECTOR FUNCTIONS (UTILITY STITCHES AND CHARACTER/DECORATIVE STITCHES)

Projection Area of Projector

When the machine is sewing utility stitches or character/decorative stitches, the projection area of the projector is as shown below.

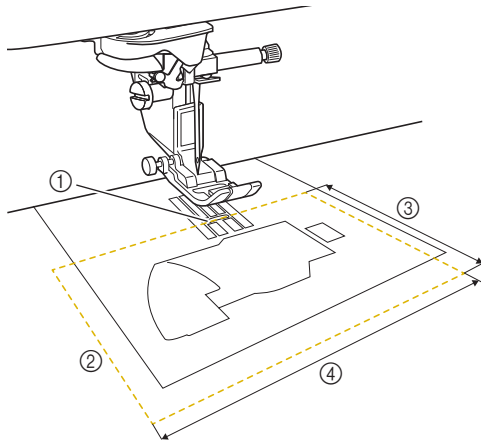

- ① Needle drop point
- ② Projection area
- ③ 7.6 cm (3 inches)
- ④ 12.7 cm (5 inches)

Note

- A stitch pattern cannot be selected from the LCD while a stitch pattern is being projected by the projector. In order to select a stitch pattern from the LCD, press in the screen.

Projecting the Stitch Pattern with the Projector

Using the projector, the selected stitch pattern can be projected onto the fabric.

1 Select a stitch pattern.

2 Press .

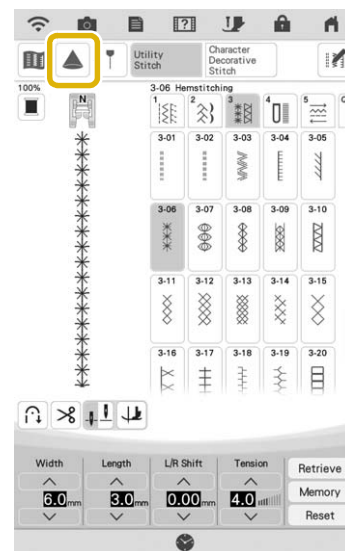

→ The selected stitch pattern and the adjustment keys are projected onto the fabric.

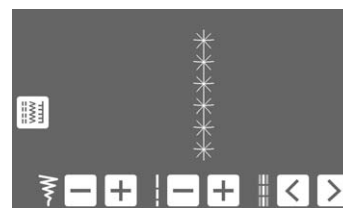

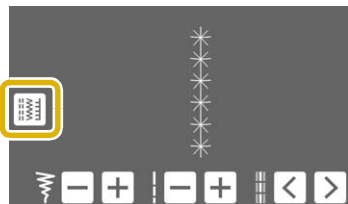

Selecting a Stitch Pattern with the Dual Purpose Stylus

- 1 When the stitch pattern is projected onto the fabric, press  with the dual purpose stylus.



→ A stitch pattern can be selected.

- 2 Press  with the dual purpose stylus until the desired stitch pattern is displayed, and then press .

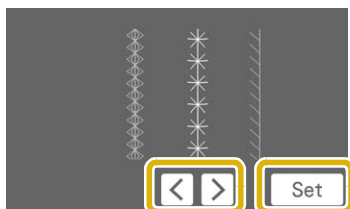

Editing a Stitch Pattern Selected with the Dual Purpose Stylus

The stitch width, stitch length and “L/R Shift” can be changed for the stitch pattern projected by the projector.

- 1 Use the dual purpose stylus to adjust the stitch width, stitch length and sewing position.

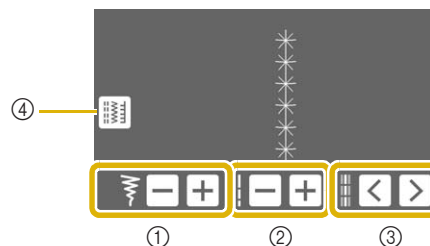

- ① Stitch width setting
 - ② Stitch length setting
 - ③ “L/R Shift” setting
 - ④ Press to select a different stitch pattern.
- The specified settings are applied to the projected stitch pattern.



Memo

- When the stitch selection screen appears again in the LCD, the settings change to those specified with the dual purpose stylus.
- With twin needle sewing, the stitch width is specified based on the left needle.

Projecting the Guidelines with the Projector

With the guideline function, sewing can easily be done by following the lines and marks projected onto the fabric.

1 Press .

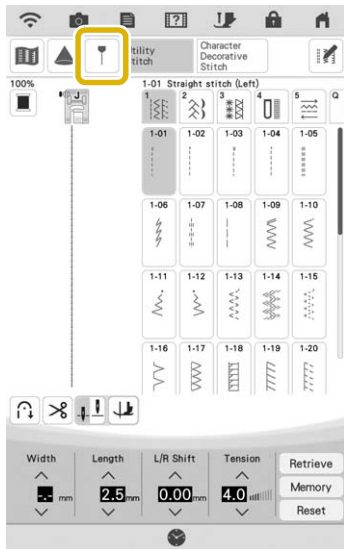

→ The guideline settings screen appears.

2 Specify the guideline settings.
Main guideline

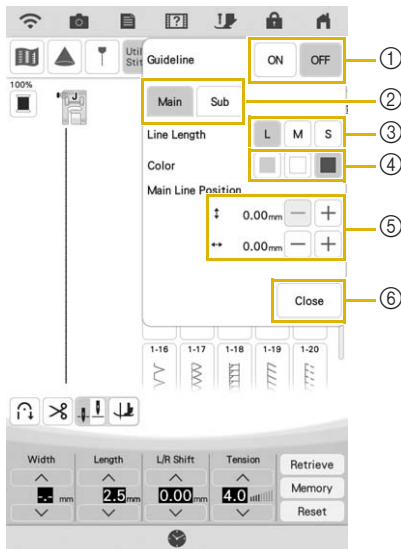

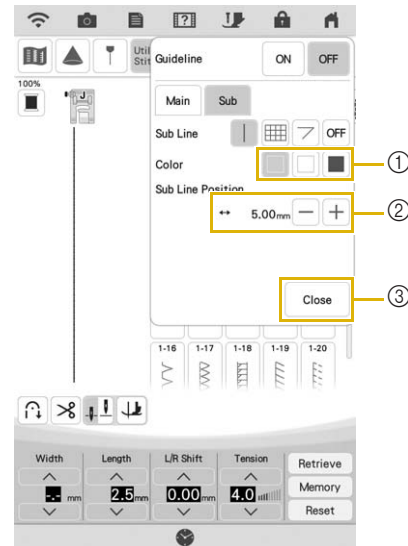

- ① If the guidelines will not be used, select "OFF".
- ② Select the guideline whose settings are to be specified.
- ③ Select the length of the main guideline.
- ④ Select the color of the main guideline.
- ⑤ Specify the position of the main guideline.
- ⑥ Press to finish specifying the guideline settings.

Sub guideline 



- ① Select the color of the sub guideline.
- ② Specify the position of the sub guideline.

Memo

- When  or  is selected, the position of the sub guideline is based on the position of the main guideline. When the position of the sub guideline is changed, change the position of the main guideline.

③ Press to finish specifying the guideline settings.

Sub guideline 

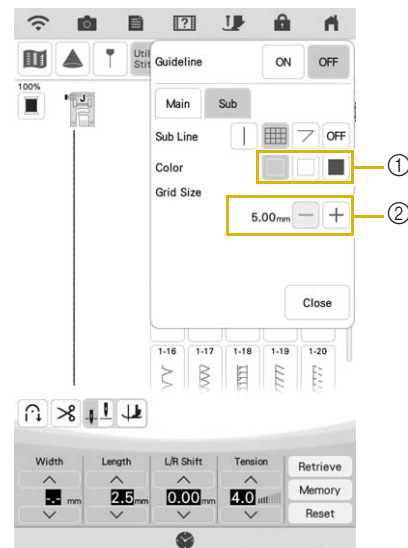

- ① Select the color of the sub guideline.
- ② Specify the grid size of the sub guideline.

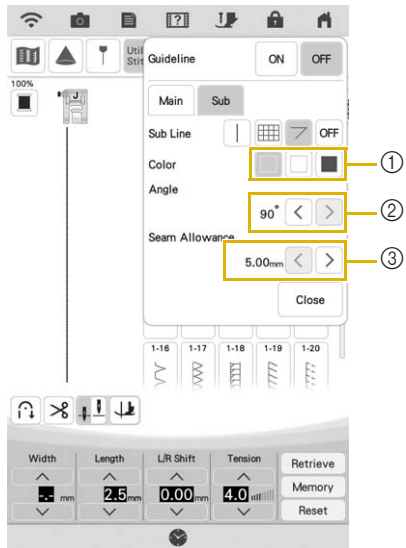
Sub guideline 

- ① Select the color of the sub guideline.
- ② Specify the angle of the sub guideline.
- ③ Specify the seam allowance of the sub guideline.



Chapter **3**
Utility Stitches



SELECTING UTILITY STITCHES

Utility Stitch LCD Screen

Press a key with your finger to select the stitch pattern, to select a machine function, or to select an operation indicated on the key.

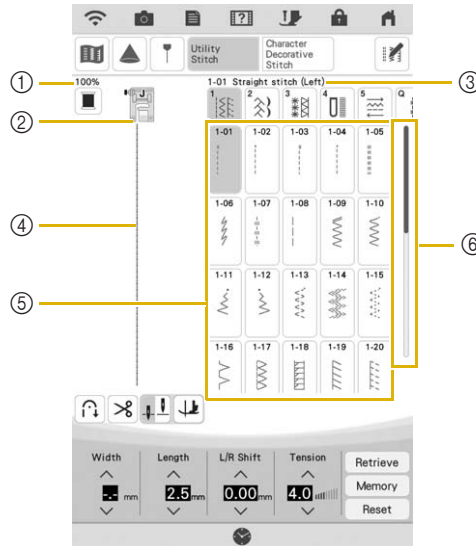

No.	Display	Key Name	Explanation	Page
①	100%	Stitch pattern display size	Shows the approximate size of the stitch pattern selected. 100% : Nearly the same size as the sewn stitch pattern * The actual size of the sewn stitch pattern may differ depending on the type of fabric and thread that is used.	105
②		Presser foot display	Shows the presser foot code. Attach the presser foot indicated in this display before sewing.	72
③	1-01 Straight stitch (Left)	Selected stitch display	Shows the name and code number of the selected stitch.	105
④		Stitch preview	Shows a preview of the selected stitch. When shown at 100%, the stitch appears in the screen at nearly its actual size. Press to display the stitch preview and the camera view together to check how the stitch will be sewn on the actual fabric.	92, 105
⑤		Stitch selection screen	Press the key for the stitch pattern you want to sew. Use to change to different stitch groups.	105
⑥		Scroll bar	Slide the scroll bar to move the pages of stitch selection screen.	104

* All key functions of the LCD are explained in the “Key Functions” table on the following page.









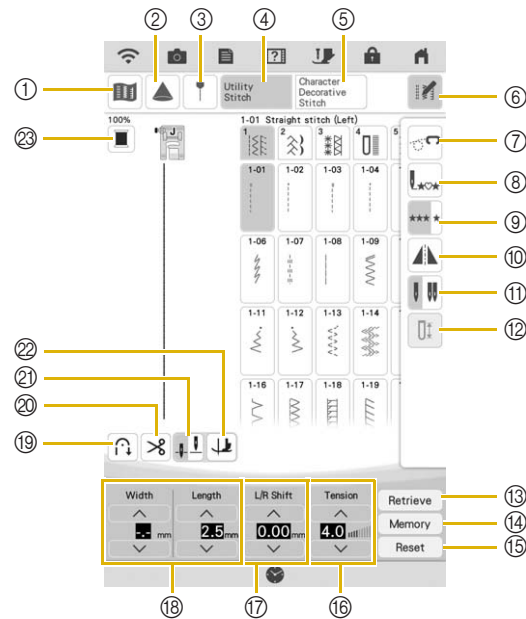





Key Functions



Note

- Editing function keys are found after pressing  .



No.	Display	Key Name	Explanation	Page
①		Image key	Press this key to display an enlarged image of the selected stitch pattern.	106
②		Projector key	Press this key to use projector functions.	96
③		Guideline marker key	Press this key to display or set the guideline marker for the sewing line. The guideline marker makes quilt piecing or aligning stitching on the fabric edge easier.	98
④		Utility stitch key	Press this key to select a straight stitch, zigzag stitch, buttonhole, blind hem stitch, or other stitches commonly used in garment construction.	105
⑤		Character/Decorative stitch key	Press this key to select character or decorative stitch patterns.	158
⑥		Edit key	Press this key to display editing function keys on the screen.	166
⑦		Free motion mode key	Press this key to enter free motion sewing mode. The presser foot is raised to an appropriate height and the feed dog is lowered for free motion quilting.	126
⑧		Back to beginning key	When sewing is stopped, press this key to return to the beginning of the stitch.	106
⑨		Single/Repeat sewing key	Press this key to choose single stitches or continuous stitches.	106
⑩		Mirror image key	Press this key to create a mirror image of the selected stitch pattern. If the key display is light gray, a mirror image of the selected stitch pattern cannot be sewn.	105
⑪		Needle mode selection key (single/double)	Press this key to select twin needle sewing mode. The sewing mode changes between single needle mode and twin needle mode each time you press the key. If the key display is light gray, the selected stitch pattern cannot be sewn in the twin needle mode.	64
⑫		Slit length key	Press this key to manually set the buttonhole length when a buttonhole stitch is selected.	144
⑬		Retrieve key	Press this key to retrieve a saved stitch pattern.	107
⑭		Manual memory key	Change the stitch pattern settings (zigzag width and stitch length, thread tension, automatic thread cutting or automatic reinforcement stitching, etc.), then save them by pressing this key. Five sets of settings can be saved for a single stitch pattern.	107
⑮		Reset key	Press this key to return the selected stitch pattern saved settings to the default settings.	85-87

No.	Display	Key Name	Explanation	Page
16		Thread tension key	Shows the automatic thread tension setting of the currently selected stitch pattern. You can use and to change the thread tension settings.	87
17		"L/R Shift" key	Press to shift the stitch pattern to the right or press to shift the stitch pattern to the left. This feature is not available for all stitch patterns. Only those applicable will be shifted. The machine default setting is highlighted.	86
18		Stitch width and stitch length key	Shows the zigzag width and stitch length settings of the currently selected stitch pattern. You can use and to adjust the zigzag width and stitch length settings.	85, 86
19		Automatic reinforcement stitch key	Press this key to use the automatic reinforcement stitching (reverse stitching) setting. If you select this setting before sewing, the machine will automatically sew reinforcement stitches at the beginning and end of sewing (depending on the stitch pattern, the machine may sew reverse stitches).	79
20		Automatic thread cutting key	Press this key to set the automatic thread cutting function. Set the automatic thread cutting function before sewing to have the machine automatically sew reinforcement stitches at the beginning and end of sewing (depending on the stitch pattern, the machine may sew reverse stitches) and trim the threads after sewing.	88
21		Needle position setting key	Press this key to select the needle stop position to be up or down. You can also check the needle mode setting (single or twin). Single needle/down position Single needle/up position Twin needle/down position Twin needle/up position	64, 89
22		Pivot key / Auto Up key	Press this key to select the pivot function. When the pivot function is selected, stopping the machine lowers the needle and slightly raises the presser foot automatically. In addition, when sewing is restarted, the presser foot is automatically lowered.	89
23		Thread color change key	Press this key to change the thread color displayed on the screen.	106

Stitch Selection Screens

There are seven categories of Utility Stitches.

Straight/Overcasting

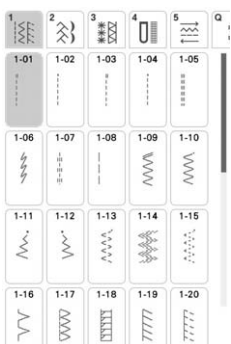

Decorative Stitches

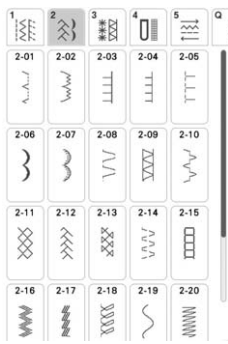

Heirloom Stitches

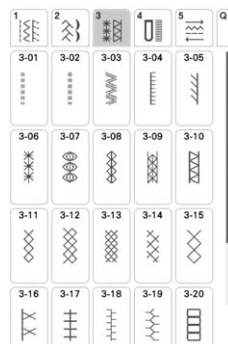

Buttonholes/Bar tacks

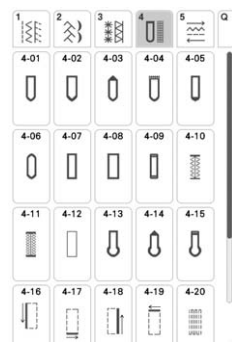

Multi-directional Sewing

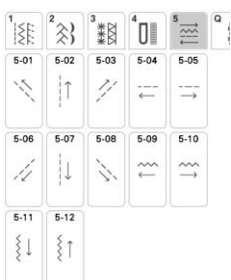

Quilting Stitches

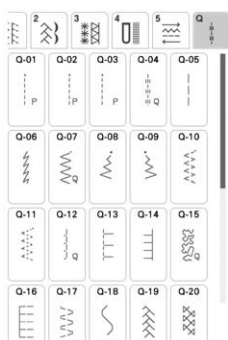

Other stitches

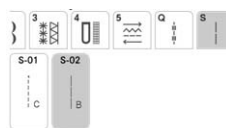

Selecting a Stitch

- 1 Turn the main power to ON and press  to display the utility stitches.

→ Either “1-01 Straight stitch (Left)” or “1-03 Straight stitch (Middle)” is selected, depending on the setting selected in the settings screen.

- 2 Use        to select the category you want.

Memo

- Swipe the key of a category or stitch pattern sideways to display hidden categories.

- 3 Press the key of the stitch you want to sew.

Memo

- For details on each stitch, refer to “STITCH SETTING CHART” on page 206.

Using the Mirror Image Key

Depending on the type of utility stitch you select, you may be able to sew a horizontal mirror image of the stitch.

If  is lit when you select a stitch, it will be possible to make a mirror image of the stitch.

Note

- If  is light gray after you select a stitch, you cannot create a horizontal mirror image of the selected stitch due to the type of stitch or type of presser foot recommended (this is true of buttonholes, multi-directional sewing, and others).

Press  to create a horizontal mirror image of the selected stitch.

The key will display as .



■ Returning to the Beginning of the Stitch

Even if you stopped stitching while sewing, you can return to the beginning of the stitch pattern. This function is useful after trial sewing or when the stitching is sewn incorrectly.

Press  before start sewing, to return to the beginning of the stitch.

- ① Stop stitching
- ② Re-start stitching

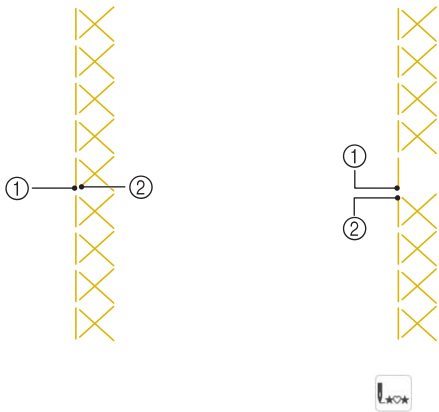

■ Sewing Continuous/Single Stitch Sewing

Press  to select continuous sewing or single stitch sewing.

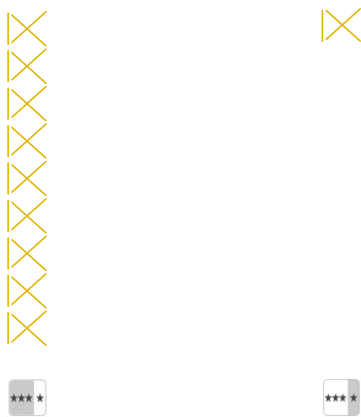



■ Using the Image Key

You can display an image of the selected stitch. You can check and change the colors of the image of the screen.

- 1 Press .

→ An image of the selected stitch is displayed.

- 2 Press  to change the thread color of the stitch on the screen.

* Press  to display an enlarged image of the stitch.

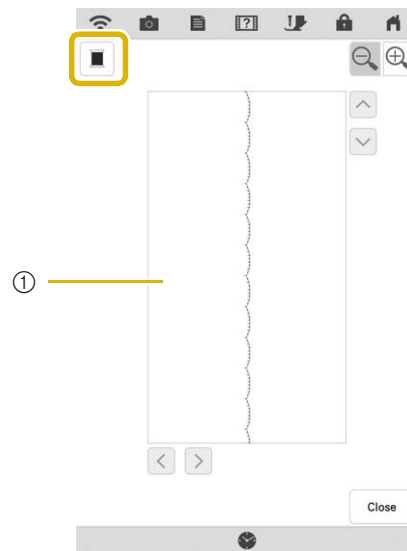

① Stitch screen



Memo

- The color changes every time you press



- 3 Press  to go back to the original screen.

Saving Your Stitch Settings

The settings for the zigzag stitch width, stitch length, thread tension, automatic thread cutting, automatic reinforcement stitching, etc., are preset in the machine for each stitch. However, if you have specific settings that you wish to reuse later for a stitch, you can change the settings so that they can be saved for that stitch. Five sets of settings can be saved for a single stitch.

■ Saving Settings

1 Select a stitch. (Example: 1-13)

2 Specify your preferred settings.

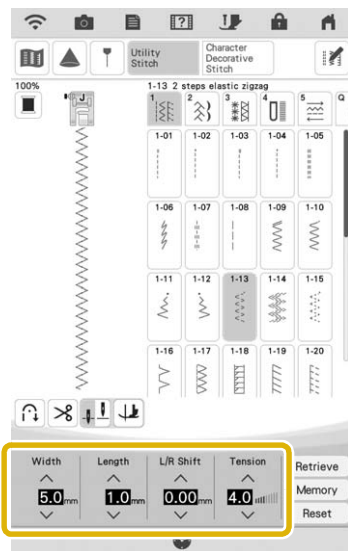

3 Press **Memory**.

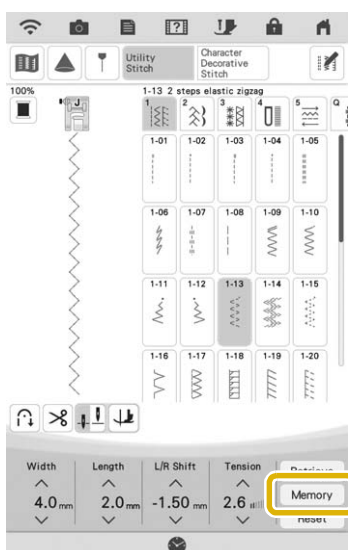

→ The settings are saved and the original screen automatically appears.

📖 Memo

- If you try to save settings when there are already 5 sets of settings saved for a stitch, the message “The pockets are full. Delete a pattern” will appear. Close the message and delete a setting referring to page 107.

■ Retrieving Saved Settings

1 Select a stitch.

📖 Memo

- When a stitch is selected, the last settings retrieved are displayed. The last settings retrieved are retained even if the machine was turned off or a different stitch was selected.

2 Press **Retrieve**.

3 Press the numbered key of the settings to be retrieved.

- * Press **Cancel** to return to the original screen without retrieving settings.

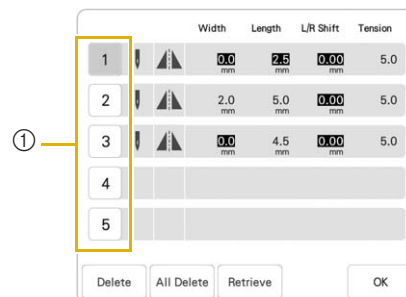

① Numbered keys

4 Press **Retrieve**.









- The selected settings are retrieved, and the original screen automatically appears.

📖 Memo

- To save new settings when there are already 5 sets of settings saved for a stitch, press **Retrieve**. Press the numbered key of the setting to be deleted. Press **Delete**, press **OK** and then **Memory**. The new setting will be saved in place of the recently deleted setting.
- You can delete all the saved settings by pressing **All Delete**.

SEWING THE STITCHES

Straight Stitches

Stitch	Stitch name	Presser foot
1-01	Straight stitch (Left)	
1-02	Straight stitch (Left)	
1-03	Straight stitch (Middle)	
1-04	Straight stitch (Middle)	
1-05	Triple stretch stitch	
1-06	Stem stitch	
1-07	Decorative stitch	
1-08	Basting stitch	

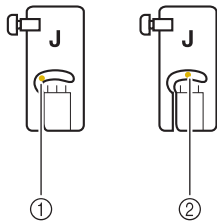

- ① Left needle position
- ② Middle needle position

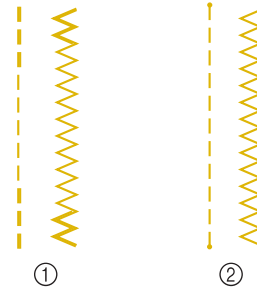

- ① Reverse stitch
- ② Reinforcement stitch



Memo

- If the selected stitch has a double mark “ ” at the top of the key display, you can sew reverse stitches holding the “Reverse Stitch” button (page 79).
- If the selected stitch has a dot mark “ . ” at the top of the key display, you can sew reinforcement stitches holding the “Reinforcement Stitch” button.

1 Select a stitch.

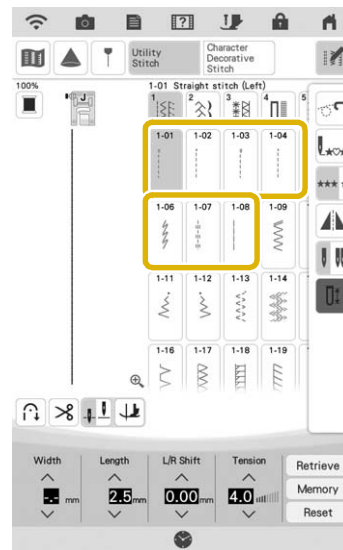

2 Attach presser foot “J”.

* Attach presser foot “N” when you select .

- 3** Hold the thread tail and fabric with your left hand, and push the “Needle Position” button with your right hand to insert the needle into the fabric.

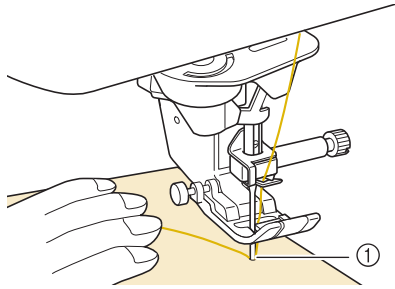

① Sewing start position

- 4** Lower the presser foot, and hold the “Reverse Stitch” button or the “Reinforcement Stitch” button to sew 3-4 stitches.

→ The machine sews reverse stitches or reinforcement stitches.

- 5** Press the “Start/Stop” button to sew forward.

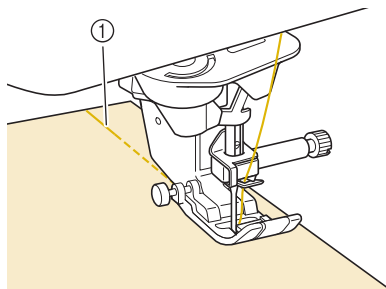

① Reverse stitches or reinforcement stitches

→ The machine will begin sewing slowly.

⚠ CAUTION

- Be sure the needle does not strike a basting pin, or any other objects, during sewing. The thread could tangle or the needle could break, causing injury.

- 6** When sewing is completed, hold the “Reverse Stitch” button or the “Reinforcement Stitch” button to sew 3-4 reverse stitches or reinforcement stitches at the end of the seam.

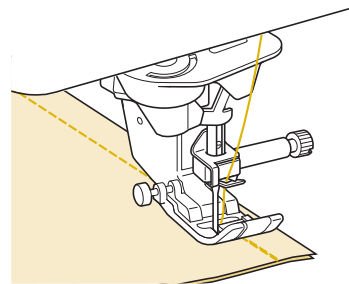

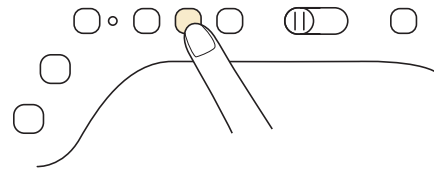

- 7** After sewing, press the “Thread Cutter” button to trim the threads.



📖 Memo

- When the automatic thread cutting and automatic reinforcement stitch keys on the screen are selected, reverse stitches or reinforcement stitches will be sewn automatically at the beginning of sewing when the “Start/Stop” button is pressed. Press the “Reverse Stitch” button or the “Reinforcement Stitch” button to sew reverse stitches or reinforcement stitches and trim the thread automatically at the end of sewing.

Changing the Needle Position (Left or Middle Needle Position Stitches Only)

When you select left or middle needle position stitches, you can use  and  in the L/R Shift display to change the position of the needle. Match the distance from the right edge of the presser foot to the needle with the stitch width, then align the edge of the presser foot with the edge of the fabric during sewing for an attractive finish.

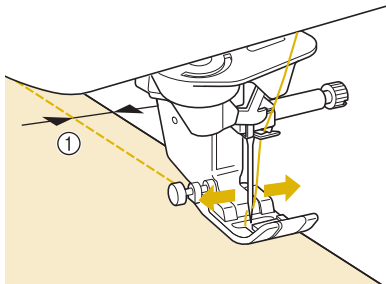

① Stitch width

Example: Left/Middle needle position stitches

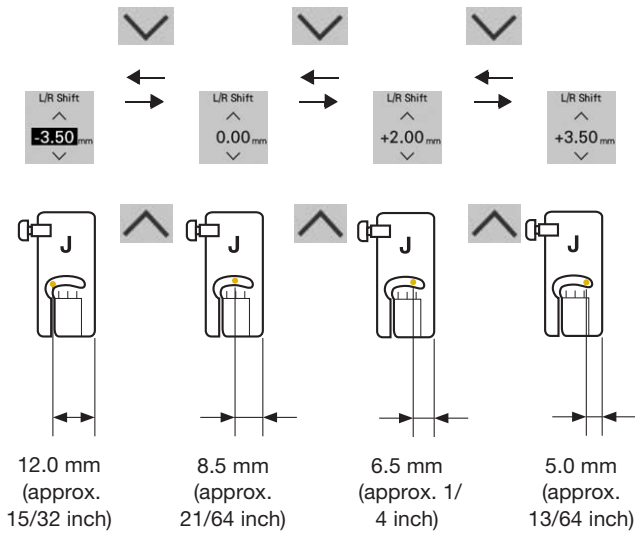

Aligning the Fabric with a Mark on the Needle Plate or Bobbin Cover (with Mark)

While sewing, align the edge of the fabric with the 16 mm (approx. 5/8 inch) mark on the needle plate or bobbin cover (with mark) depending on the needle position (left or middle (center) needle position stitches only).

For stitches with a left needle position (Stitch width: 0.0 mm)

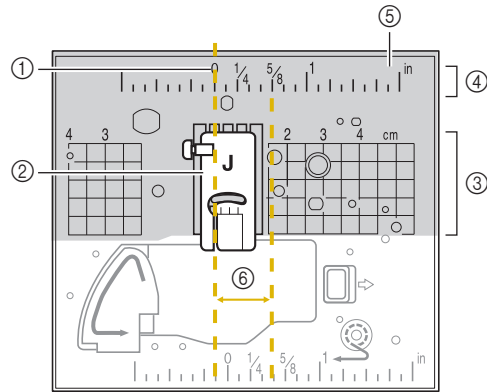

- ① Seam
- ② Presser foot
- ③ Centimeters
- ④ Inches
- ⑤ Needle plate
- ⑥ 16 mm (5/8 inch)

For stitches with a middle (center) needle position (Stitch width: 3.5 mm)

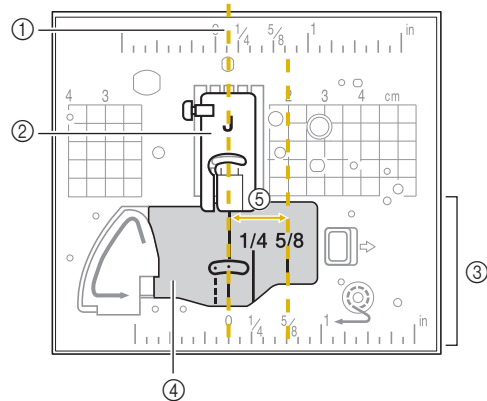

- ① Seam
- ② Presser foot
- ③ Inches
- ④ Bobbin cover (with mark)
- ⑤ 16 mm (5/8 inch)

■ Using the Straight Stitch Needle Plate and the Straight Stitch Foot

The straight stitch needle plate and the straight stitch foot can only be used for straight stitches (middle needle position stitches). Use the straight stitch needle plate and the straight stitch foot when sewing thin fabrics or when sewing small pieces which tend to sink into the hole of the regular needle plate during sewing. The straight stitch foot is perfect to reduce puckering on lightweight fabrics. The small opening on the foot provides support for the fabric as the needle travels through the fabric.

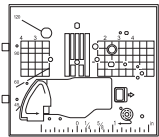
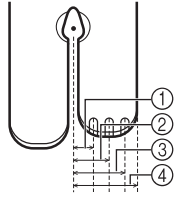

- ① 2.25 mm (1/8 inch)
- ② 4.25 mm (3/16 inch)
- ③ 6.25 mm (1/4 inch)
- ④ 8.5 mm (5/16 inch)

⚠ CAUTION

- Always use the straight stitch foot in combination with the straight stitch needle plate.

- 1 Press the “Needle Position” button to raise the needle and turn the main power to OFF or press  to lock all keys and buttons.
- 2 Remove the needle and the presser foot holder (refer to page 69, 73).
- 3 Remove the flat bed attachment or the embroidery unit if either are attached.
- 4 Slide the needle plate lever toward you.

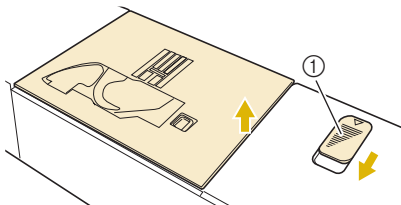

- ① Slide toward you.
- The needle plate opens.

- 5 Slide out the regular needle plate with your right hand to remove it.

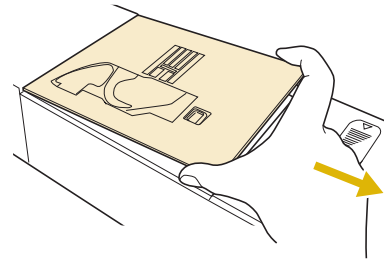

- 6 Insert the tabs on the straight stitch needle plate into the notches in the machine.

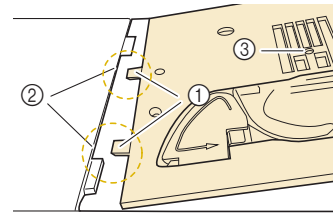

- ① Tabs
- ② Notches
- ③ Round hole

- 7 Press down on the right side of the straight stitch needle plate to secure it.

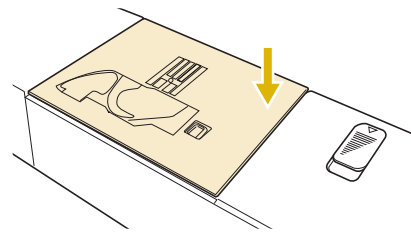

- 8 Select any of the straight stitches.



Note

- Selecting other stitches will cause an error message to be displayed.
- After installing straight stitch needle plate, you must turn the machine OFF, then back to ON to reset the straight stitch settings.

Memo

- When using the straight stitch needle plate, many straight stitches become middle needle position stitches. If a straight stitch is selected that is not applicable for use when the straight stitch needle plate is attached, an error message will be displayed to prevent the use of this stitch. You cannot change the needle position using the L/R Shift.

CAUTION

- Slowly rotate the handwheel toward you (counterclockwise) before sewing and make sure that the needle is not contacting the straight stitch foot and straight stitch needle plate.

- 9** Insert needle and attach the straight stitch foot.

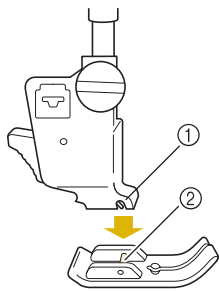

- ① Notch
- ② Pin

- 10** Press **U** to unlock all keys and buttons, and then start sewing.

- * After sewing, make sure to remove the straight stitch needle plate and the straight stitch foot, and reinstall the regular needle plate and the presser foot “J”.

Memo

- To prevent puckering on fine fabrics, use a fine needle, size 75/11, and a short stitch length. For heavier fabrics, use a heavier needle, size 90/14, and longer stitches.

Dart Seam

- 1** Select **1-01** and attach presser foot “J”.
- 2** Sew a reverse stitch at the beginning of the dart and then sew from the wide end to the other end without stretching the fabric.

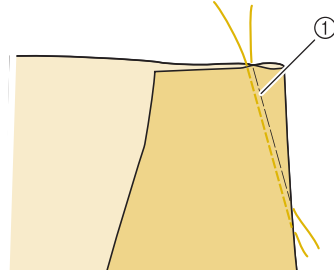

① Basting

- 3** Cut the thread at the end leaving 50 mm (approx. 1-15/16 inches), and then tie both ends together.

- * Do not sew a reverse stitch at the end.

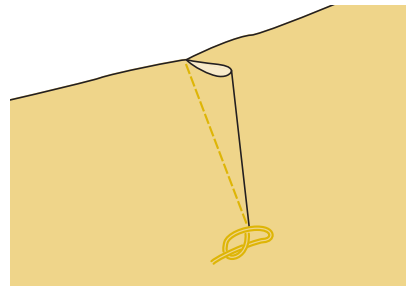

- 4** Insert the ends of the thread into the dart with a hand sewing needle.

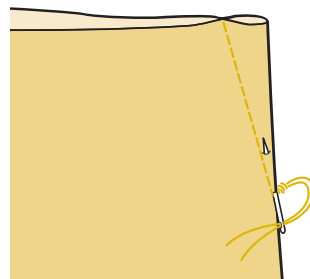

- 5** Iron the dart to one side so that it is flat.

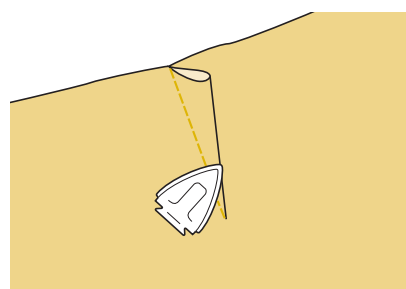

Gathering

Use on waists of skirts, sleeves of shirts, etc.

- 1 Select a straight stitch and attach presser foot "J".

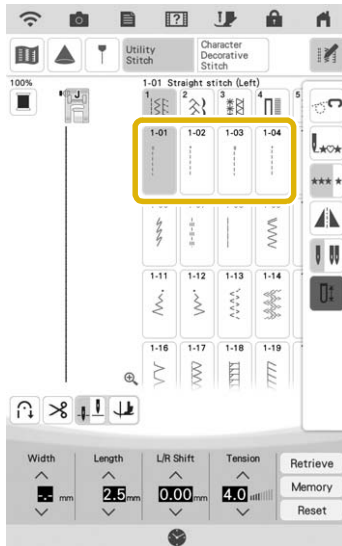

- 2 Set the stitch length to 4.0 mm (approx. 5/32 inch) and the thread tension to approximately 2.0 (weaker tension).
- 3 Pull the bobbin and upper threads out by 50 mm (approx. 1-15/16 inches) (page 59).

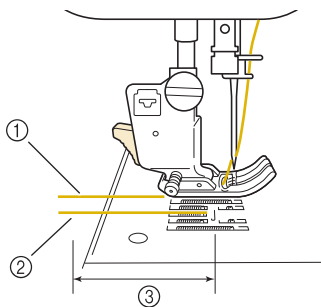

- 1 Upper thread
- 2 Bobbin thread
- 3 About 50 mm (approx. 1-15/16 inches)

- 4 Sew two rows of straight stitches parallel to the seam line, then trim excess thread leaving 50 mm (approx. 1-15/16 inches).

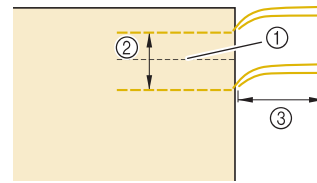

- 1 Seam line
- 2 10 to 15 mm (approx. 3/8 inch to 9/16 inch)
- 3 About 50 mm (approx. 1-15/16 inches)

- 5 Pull the bobbin threads to obtain the desired amount of gather, then tie the threads.

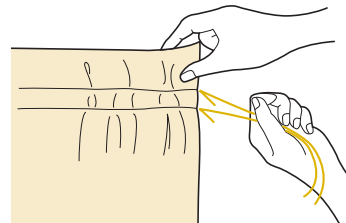

- 6 Smooth the gathers by ironing them.

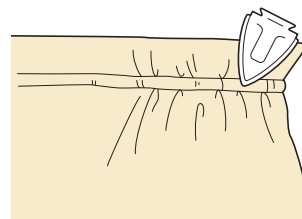

- 7 Sew on the seam line and remove the basting stitch.

Flat Fell Seam

Use for reinforcing seams and finishing edges neatly.

- 1 Select  and attach presser foot "J".
- 2 Sew the finish line, then cut half of the seam allowance from the side on which the flat fell seam will lie.

* When the automatic thread cutting and automatic reinforcement stitching are preset, reverse stitches will be sewn automatically at the beginning of sewing. Press the "Reinforcement Stitch" button to sew a reinforcement stitch and trim the thread automatically at the end of sewing.

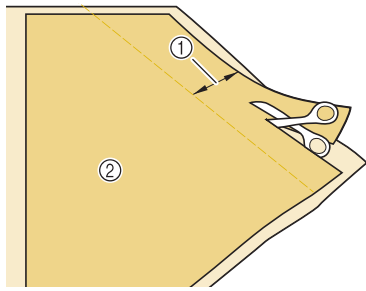

- ① About 12 mm (approx. 1/2 inch)
- ② Wrong side

3 Spread the fabric out along the finish line.

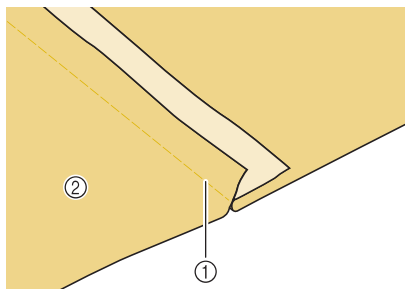

- ① Finish line
- ② Wrong side

4 Lay both seam allowances on the side of the shorter seam (cut seam) and iron them.

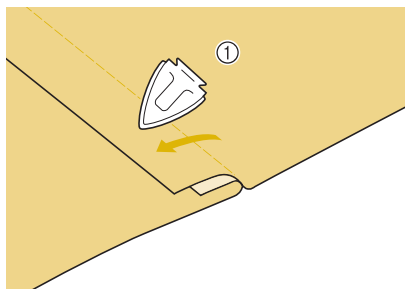

- ① Wrong side

5 Fold the longer seam allowance around the shorter one, and sew the edge of the fold.

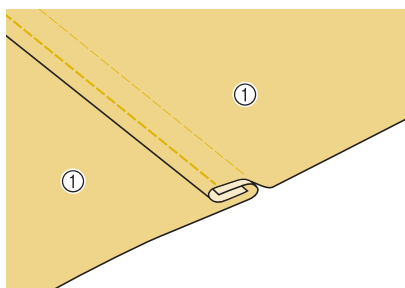

- ① Wrong side

Finished flat fell seam

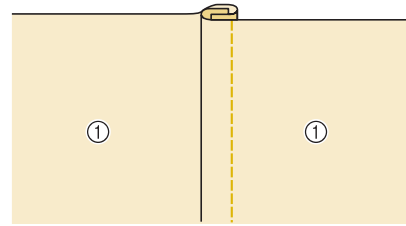

- ① Surface

Pintuck

1 Mark along the folds on the wrong side of the fabric.

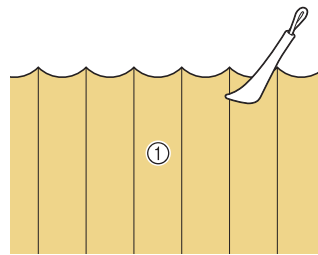

- ① Wrong side

2 Turn the fabric and iron the folded parts only.

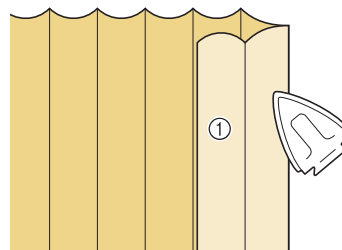

- ① Surface

3 Select  and attach presser foot "1".

4 Sew a straight stitch along the fold.

- * When the automatic thread cutting and automatic reinforcement stitching are preset, reverse stitches will be sewn automatically at the beginning of sewing. Press the "Reinforcement Stitch" button to sew a reinforcement stitch and trim the thread automatically at the end of sewing.

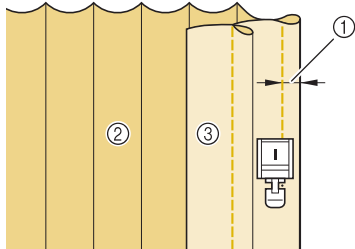

- ① Width for pintuck
- ② Wrong side
- ③ Surface

5 Iron the folds in the same direction.

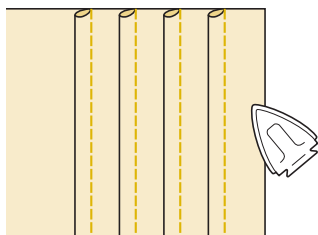





Zigzag Stitches

Zigzag stitches are useful for overcasting, appliqué, patchwork, and many other applications.

Select a stitch, and attach presser foot “J”. If the stitch which you select has a double mark “= ” at the top of the key display, you can sew reverse stitches by holding the “Reverse Stitch” button. (page 79)

If the stitch which you select has a dot mark “· ” at the top of the key display, you can sew reinforcement stitches by holding the “Reinforcement Stitch” button (page 79).

Stitch	Stitch name	Presser foot
1-09	Zigzag stitch	
1-10	Zigzag stitch	
1-11	Zigzag stitch (Right)	
1-12	Zigzag stitch (Left)	

1 Select a stitch.

2 Attach presser foot “J”.

Overcasting (Using a Zigzag Stitch)

Sew the overcasting along the edge of the fabric while positioning the right-hand side needle drop point just outside the edge of the fabric.

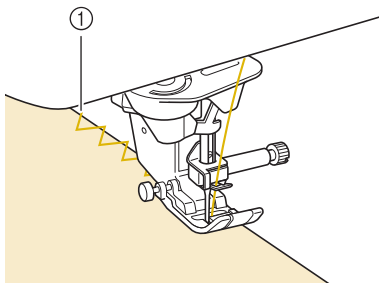

① Needle drop position

Appliqué (Using a Zigzag Stitch)

Attach the appliqué material using a temporary spray adhesive or basting, and then sew it.

- * Sew a zigzag stitch while positioning the right-hand side needle drop point just outside the edge of the fabric.

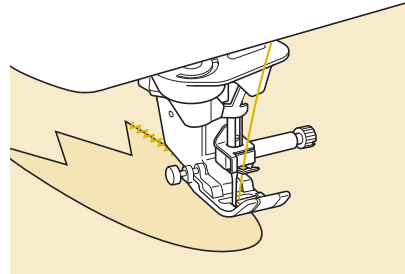

Patchwork (for Crazy Quilt)

Turn back the desired width of fabric and position it over the lower fabric, then sew so that the stitch bridges both pieces of fabric.

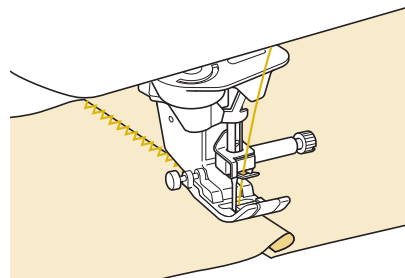

Sewing Curves (Using a Zigzag Stitch)

Shorten the stitch length setting to obtain a fine stitch. Sew slowly, keeping the seams parallel with the fabric edge as you guide the fabric around the curve.

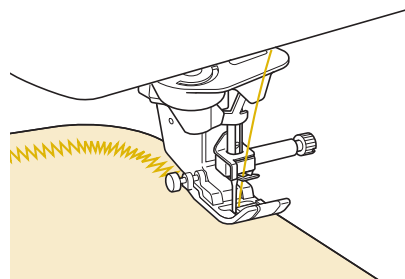

■ Cord Guide Bobbin Cover (Using a Zigzag Stitch)

- 1 Remove the bobbin cover from the machine (page 58).
- 2 Thread the gimp thread through the hole in the cord guide bobbin cover from bottom to top. Position the thread in the notch at the back of the cord guide bobbin cover.

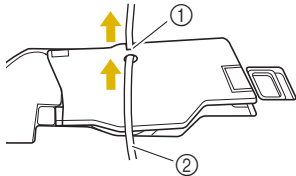

- ① Notch
- ② Gimp thread

- 3 Snap the cord guide bobbin cover into place, making sure that the gimp thread can be fed freely.

* Make sure there are no restrictions when feeding the thread.

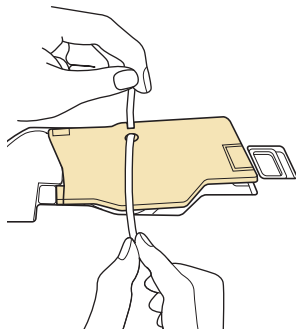

- 4 Set the zigzag width from 2.0-2.5 mm (approx. 1/16 - 3/32 inch).
- 5 Attach presser foot "N".
- 6 Position the fabric right side up on top of the cord and place the cord to the rear of the machine under the presser foot.

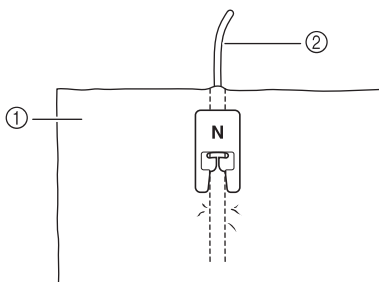

- ① Fabric (right side)
- ② Gimp thread

- 7 Lower the presser foot and start sewing to make a decorative finish.

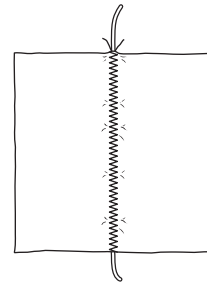

Elastic Zigzag Stitches

Use elastic zigzag stitches for tape attaching, overcasting, darning, or a wide variety of other uses.

Stitch	Stitch name	Presser foot
1-13	2 steps elastic zigzag	
1-14	2 steps elastic zigzag	
1-15	3 steps elastic zigzag	

- 1 Select a stitch.
- 2 Attach presser foot "J".

■ Tape Attaching

While stretching the tape flat, sew it to the fabric.

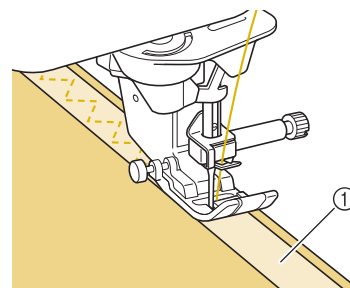

- ① Tape

Overcasting

Use this stitch to sew overcasting on the edge of stretch fabrics. Sew the overcasting along the edge of the fabric while positioning the right-hand side needle drop point just outside the edge of the fabric.

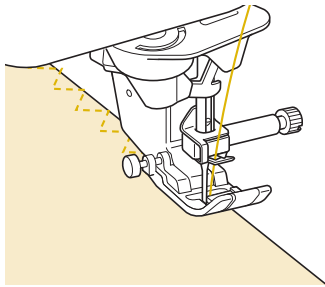

Overcasting

Use for the edge of seams in skirts or trousers, and the edge of all cuttings. Use presser foot “G”, presser foot “J”, or the side cutter attachment depending on the kind of overcasting stitch you select.

Overcasting Using Presser Foot “G”

Stitch	Stitch name	Presser foot
1-16	Overcasting stitch	
1-17	Overcasting stitch	
1-18	Overcasting stitch	

1 Select a stitch and attach presser foot “G”.

2 Lower the presser foot so that the presser foot guide is set flush against the edge of the fabric.

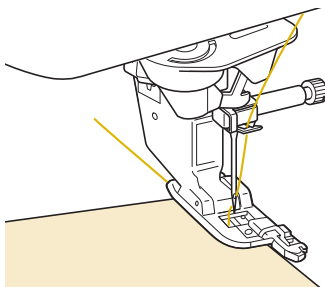

3 Sew along the presser foot guide.

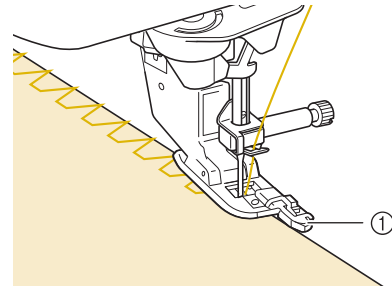

① Guide

CAUTION

- After the stitch width is adjusted, rotate the handwheel toward you (counterclockwise). Check that the needle does not touch the presser foot. If the needle hits the presser foot, the needle may break and cause injury.

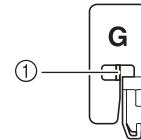

① The needle should not touch the center bar

- If the presser foot is raised to its highest level, the needle may strike the presser foot.

4 Press the “Start/Stop” button to stop sewing when you are finished, and raise the presser foot and needle to remove the fabric by pulling it back.





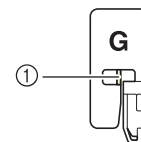

CAUTION

- Pull the fabric to the back of the machine after finished sewing. By pulling the fabric to the front or side, the center bar of the presser foot “G” may break.



① Center bar

Overcasting Using Presser Foot “J”

Stitch	Stitch name	Presser foot
1-19	Overcasting stitch	
1-20	Overcasting stitch	
1-21	Overcasting stitch	
1-22	Overcasting stitch	
1-23	Single diamond overcast	
1-24	Single diamond overcast	

- 1 Select a stitch and attach presser foot “J”.
- 2 Sew with the needle dropping slightly off the edge of the fabric.

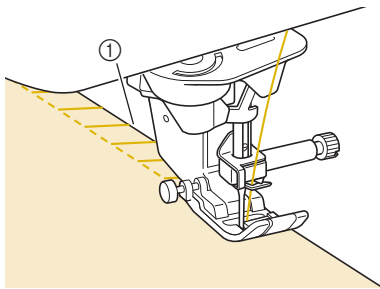

① Needle drop position



Note

- Fine adjustment of the stitching on the fabric can be done with “L/R Shift”. Before sewing your project, be sure to sew trial stitches using the same conditions as in the actual project.



Memo

- For best results when sewing stretch fabrics, decrease the pressure of the presser foot.

Overcasting Using the Side Cutter (Sold Separately)

By using the side cutter, you can do overcasting while cutting the fabric.





CAUTION

- Recommended stitches are noted “S” in the lower right corner, therefore sure to only select one of these stitches listed below. Using another stitch may cause the needle to hit the presser foot and break, possibly causing injury.



Note

- Thread the needle manually when using the side cutter, or only attach the side cutter after threading the needle using the “Automatic Threading” button.

Stitch	Stitch name	Presser foot
1-25	With side cutter	
1-26	With side cutter	
1-27	With side cutter	
1-28	With side cutter	
1-29	With side cutter	

- 1 Select a stitch.
- 2 Follow the steps on page 72 to remove the presser foot.
- 3 Thread the needle (page 61).

- 4** Position the fork on the side cutter's operating lever onto the needle clamp screw.

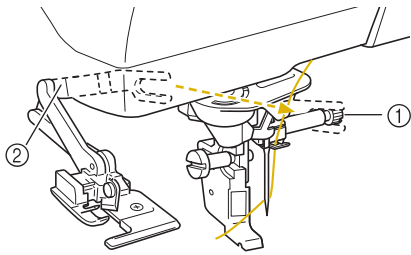

- ① Needle clamp screw
- ② Operating lever

Memo

- Make sure that the fork of the operating lever is set onto the needle screw firmly.

- 5** Position the side cutter so that the side cutter pin is aligned with the notch in the presser foot holder, and then lower the presser foot.

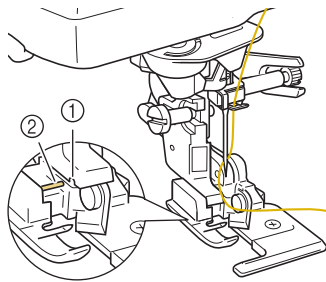

- ① Notch in presser foot holder
 - ② Pin
- The side cutter is attached.

- 6** Raise the presser foot and pull out a long section of the upper thread. Pass it below the presser foot and pull it out in the fabric feed direction.

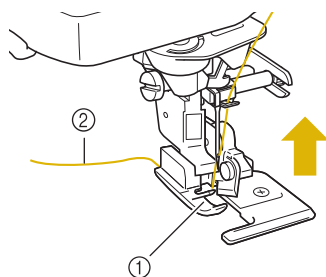

- ① Presser foot
- ② Upper thread

- 7** Make a cut of approximately 20 mm (approx. 3/4 inch) in the fabric.

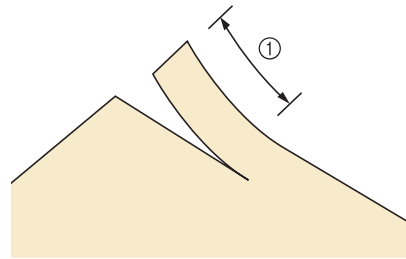

- ① 20 mm (approx. 3/4 inch)

- 8** Position the fabric so that the right side of the cut is on top of the guide plate and the left side of the cut is underneath the presser foot.

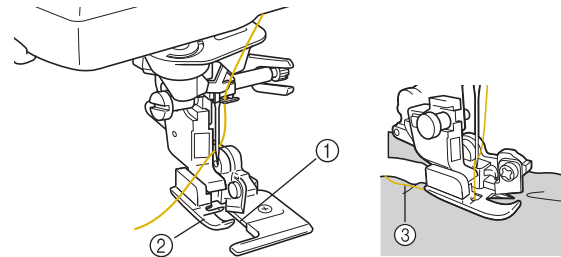

- ① Guide plate (lower knife)
- ② Presser foot
- ③ Upper thread

Memo

- If the fabric is not positioned correctly, the fabric will not be cut.

- 9** Lower the presser foot and start.

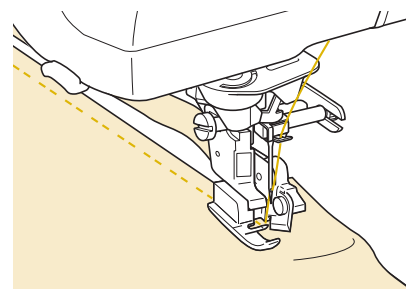

→ A seam allowance is cut while the stitching is sewn.

- When using the side cutter, sew between low and mid-speed and do not touch the knives or operation lever of the side cutter while sewing to avoid equipment damage or injury.

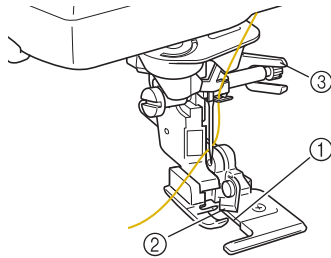

- ① Guide plate (lower knife)
- ② Upper knife
- ③ Operation lever



Note

- If the width has been adjusted, rotate the handwheel toward you (counterclockwise). Check that the needle does not touch the side cutter. If the needle touches the side cutter, it might cause the needle to break.

■ Sewing Straight Stitches While Using the Side Cutter (Sold Separately)

The seam margin should be approximately 5 mm (approx. 3/16 inch).

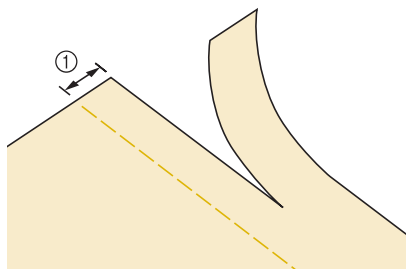

① Seam margin

Memo

- The fabric will not be cut if the whole fabric is simply spread out underneath the presser foot guide plate. Set the fabric as explained in step B from the previous section, and then start sewing.

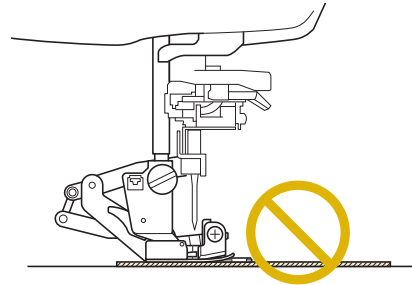





































































































- One layer of 13 oz. denim can be cut.
- Clean the side cutter after use to avoid having dust and scraps of thread build up in the cutter area.
- Add a small amount of oil as required to the cutting edge of the cutter.

Quilting

You can make beautiful quilts quickly and easily with this machine. When making a quilt, you will find it convenient to use the knee lifter and foot controller to free your hands for other tasks (“Using the Foot Controller” on page 78 and /or “Using the Knee Lifter” on page 90). The 30 quilting stitches Q-01 through Q-30 and the utility stitches with “P” or “Q” indicated on their key are useful for quilting. The “P” or “Q” at the bottom of the key display indicates that these stitches are intended for (“Q”) quilting and (“P”) piecing.

Stitch	Stitch name	Presser foot	
Q-01 P	Piecing stitch (Middle)		
Q-02 P	Piecing stitch (Right)		
Q-03 P	Piecing stitch (Left)		
Q-04 Q	Hand-look quilting (Middle)		
Q-05 P	Basting stitch		

Stitch	Stitch name	Presser foot	
			
	Stem stitch		
	Quilting appliqué zigzag stitch		
	Zigzag stitch (Right)		
	Zigzag stitch (Left)		
	2 steps elastic zigzag		
	3 steps elastic zigzag		
	Quilting appliqué stitch		
	Shell tuck edge		
	Blanket stitch		
	Quilting stippling		
	Overcasting stitch		
	Tape attaching		
	Serpentine stitch		
	Feather stitch		
	Fagoting cross stitch		
	Couching stitch		
	Patchwork double overlock stitch		
	Smocking stitch		
	Rick-rack stitch		

Stitch	Stitch name	Presser foot	
			
	Decorative stitch		
	Decorative stitch		
	Hemstitching		
	Hemstitching		
	Single diamond overcast		
	Overcasting stitch		
	Piecing stitch (Right)		
	Piecing stitch (Middle)		
	Piecing stitch (Left)		
	Hand-look quilting		
	Quilting appliqué zigzag stitch		
	Quilting appliqué stitch		
	Quilting stippling		





Memo

- When a stitch pattern in the quilting stitches category (only quilting stitches marked with “Q”) is selected, a finer stitch width can be set than that available with stitch patterns in other categories.

■ Piecing

Sewing two pieces of fabric together is called piecing. When cutting pieces for quilt blocks, make sure the seam allowance is 6.5 mm (approx. 1/4 inch).

- 1 Select  or  and attach presser foot "J".
- 2 Align the edge of the fabric with the edge of the presser foot, and start sewing.

- * To sew a 6.5 mm (approx. 1/4 inch) seam allowance along the right edge of the presser foot with  selected, the width should be set to 5.50 mm (approx. 7/32 inch).

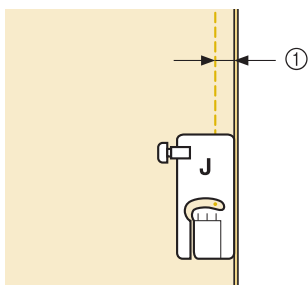

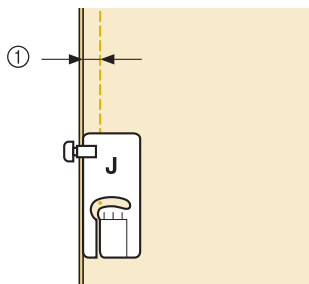

① 6.5 mm (approx. 1/4 inch)

- * To sew a 6.5 mm (approx. 1/4 inch) seam allowance along the left edge of the presser foot with  selected, the width should be set to 1.50 mm (approx. 1/32 inch).



① 6.5 mm (approx. 1/4 inch)

- * To change the needle position, use  or  in the L/R Shift display.





Memo

- Using a straight stitch (middle needle position) makes it easier to sew smoothly (page 108).
- In the case Q-01(center, at L/R Shift 3.5 mm) is selected, if the guideline marker is set at 10.0 mm (3.5 mm plus 6.5 mm, close to 1/4 inch), you can sew piecing by referring to the guideline marker.

■ Quilting

Sewing the quilt top, batting, and backing together is called quilting. You can sew the quilt with the dual feed foot to keep the quilt top, batting, and backing from sliding. The dual feed foot has a motorized belt that moves together with the feed dogs in the needle plate during sewing.

For straight line quilting, use the dual feed foot and the straight stitch needle plate. Always select a straight stitch (middle needle position) when using the straight stitch needle plate.

- 1 Select  ,  or .
- 2 Attach the dual feed foot (page 74).

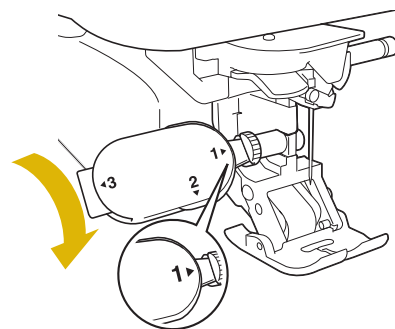

- 3 Place one hand on each side of the presser foot to hold the fabric secure while sewing.

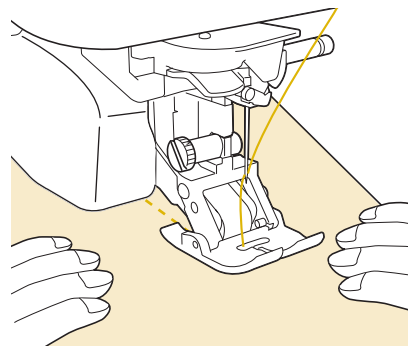

Memo

- Sew at slow to medium speed.
- Always check to be sure that your quilting surface is securely basted before beginning to sew. Specialized machine quilt needles and threads are also available for machine quilting.

■ Appliqué

- 1 Trace the pattern onto the appliqué fabric and then cut around it, leaving a 3 to 5 mm (approx. 1/8 to 3/16 inch) seam allowance.

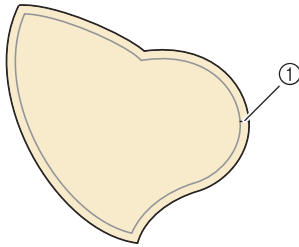

① Seam allowance: 3 to 5 mm (approx. 1/8 to 3/16 inch)

- 2 Place a piece of stabilizer cut to the finished size of the appliqué design onto the fabric, and then fold over the seam margin using an iron. Clip curves when necessary.

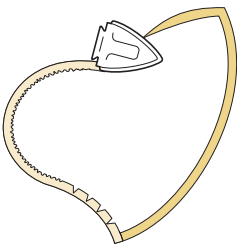

- 3 Turn the appliqué over, and attach the stabilizer with basting pins or a basting stitch.

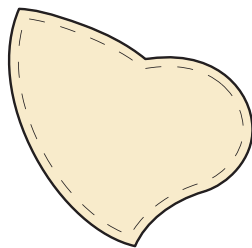

- 4 Select  and attach presser foot "J".

- 5 Use the quilting appliqué stitch to attach the appliqué. Sew around the edge while dropping the needle as close to the edge as possible.

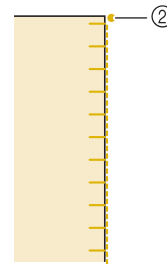
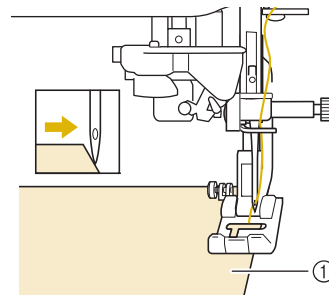
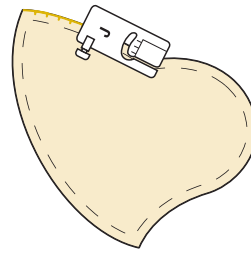

- ① Appliqué
- ② Needle drop position

⚠ CAUTION

- Be careful that the needle does not strike a basting pin during sewing. Striking a pin can cause the needle to break, resulting in injury.

You can use the appliqué technique to attach appliqué designs like the three pictured below.

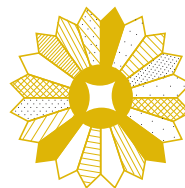

①



②





③

- ① Dresden plate
- ② Stained glass
- ③ Sunbonnet sue

■ Quilting with Satin Stitches

For better fabric control, use the foot controller to sew with satin stitches. Set the speed control slide to control the stitch width to make subtle changes in the stitch width during sewing.

- 1 Attach the foot controller (page 78).
- 2 Select  and attach presser foot “J”.
- 3 Press  in the length display to shorten the stitch length.

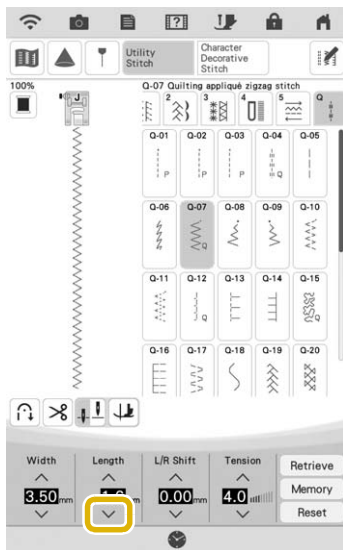

Memo

- The setting will vary according to the kind of fabric and the thickness of the thread, but a length of 0.3 to 0.5 mm (approx. 1/64 to 1/32 inch) is best for satin stitches.

- 4 Press  to use the speed control slide to control the stitch width.

- 5 Set the “Width Control” to “ON”.

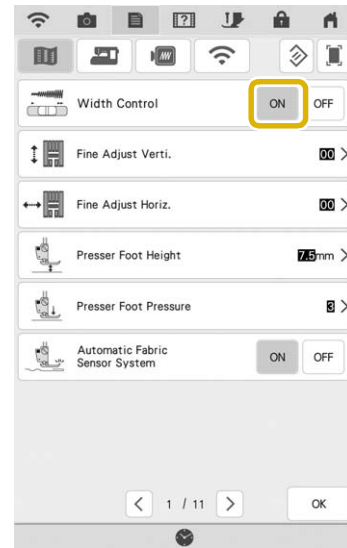

Memo

- You can use the speed control slide to adjust the stitch width. Use the foot controller to adjust the sewing speed.

- 6 Press .

→ The display will return to the original screen.

- 7 Start sewing.

- * You can adjust the stitch width during sewing by moving the sewing speed controller. Slide the lever to the left, and the stitch width becomes narrower. Slide it to the right, the stitch width becomes wider. The size of the width changes equally on both sides of the middle needle position.

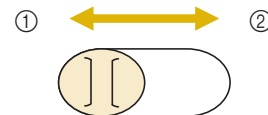

- ① narrower
- ② wider

Example: Changing the width

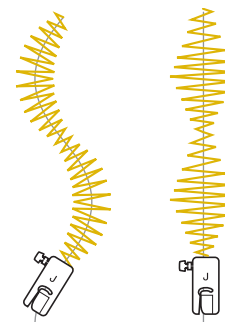

- 8 When you are finished sewing, set the “Width Control” back to “OFF”.

Free Motion Quilting

With free motion quilting, the feed dogs can be lowered by pressing , so that the fabric can be moved freely in any direction.

For free motion quilting, use free motion quilting foot “C” or free motion open toe quilting foot “O” depending on the stitch that is selected, and set the machine to free motion sewing mode. In this mode, the presser foot is raised to the necessary height for free motion sewing.

We recommend attaching the foot controller and sewing at a consistent speed. You can adjust the sewing speed with the speed control slide on the machine.

Using Free motion Quilting Foot “C”

Use the free motion quilting foot “C” with straight stitch needle plate for free motion sewing.



Free motion quilting foot “C”

CAUTION

- With free motion quilting, control the feeding speed of the fabric to match the sewing speed. If the fabric is moved faster than the sewing speed, the needle may break or other damage may result.
- When using free motion quilting foot “C”, be sure to use the straight stitch needle plate and sew with the needle in middle (center) needle position. If the needle is moved to any position other than the middle (center) needle position, the needle may break, which may result in injuries.

Memo

- When starting to sew, the internal sensor detects the thickness of the fabric, and the quilting foot is raised to the height specified in the machine settings screen. Press  to display “Free Motion Foot Height” of the settings screen. Touch the number to select the height that the quilting foot is raised above the fabric. Increase the setting, for example, when sewing very stretchy fabric, so that it is easier to sew.

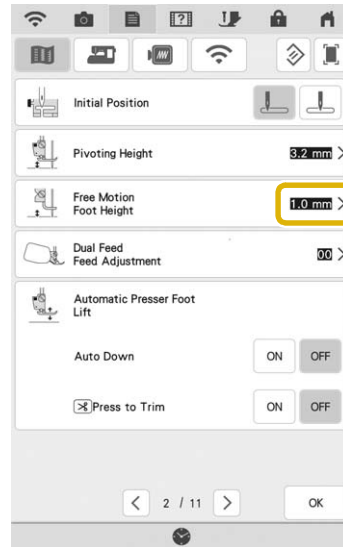

- In order to sew with a balanced tension, it may be necessary to adjust the upper thread tension. Test with a sample piece of fabric that is similar to your chosen fabric.

1 Attach the straight stitch needle plate (page 111).

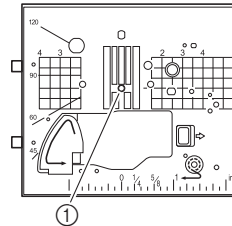

① Round hole

Memo

- Notice this needle plate has a round hole for the needle.

2 Select or .

- 3** Press  to set the machine to free motion sewing mode.

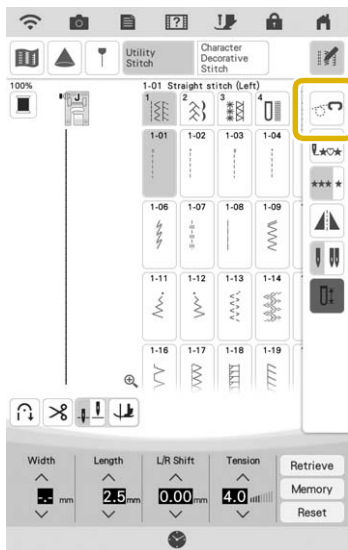

→ The key appears as , the quilting foot is raised to the necessary height, and then the feed dogs are lowered for free motion sewing.

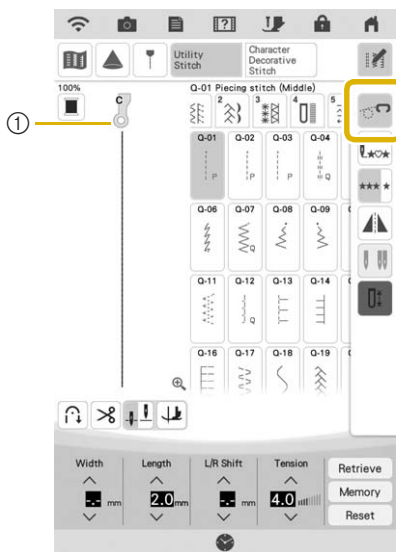

① Free motion quilting foot “C”
→ When stitch Q-01 or 1-31 is selected, free motion quilting foot “C” is indicated in the upper-left corner of the screen.

- 4** Remove the presser foot holder (page 73).

- 5** Attach free motion quilting foot “C” at the front with the presser foot holder screw aligned with the notch in the quilting foot.

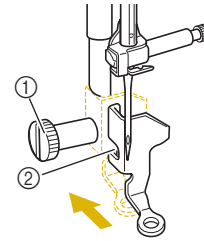

- ① Presser foot holder screw
② Notch



Note

- Make sure that the quilting foot is attached properly and not slanted.

- 6** Hold the quilting foot in place with your right hand, and tighten the presser foot holder screw using the multi-purpose screwdriver with your left hand.

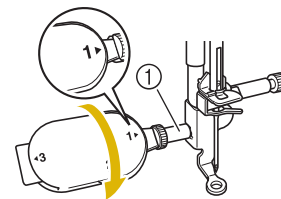

- ① Presser foot holder screw

⚠ CAUTION

- Be sure to securely tighten the screws with the included multi-purpose screwdriver. Otherwise, the needle may touch the quilting foot, causing it to bend or break.

- 7** Use both hands to stretch the fabric taut, and then move the fabric at a consistent pace in order to sew uniform stitches roughly 2.0-2.5 mm (approx. 1/16 - 3/32 inch) in length.

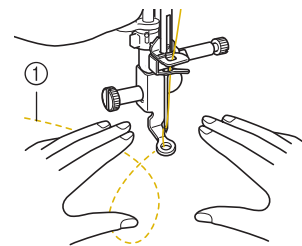

- ① Stitch

8 Press  to cancel the free motion sewing mode.

→ Rotate the handwheel toward you (counterclockwise) to raise the feed dogs.

9 After sewing, make sure to remove the straight stitch needle plate and presser foot “C”, and reinstall the regular needle plate.

Note

- Free motion open toe quilting foot “O” can also be used with the straight stitch needle plate. We recommend using free motion open toe quilting foot “O” with free motion sewing of fabrics of uneven thicknesses.
- When using the straight stitch needle plate, all straight stitches become middle needle position stitches. You cannot change the needle position using the L/R Shift.

Memo

- Normally, the feed dogs are raised for regular sewing.
- Do not be discouraged with your initial results. The technique requires practice.

Using free motion Open Toe Quilting Foot “O”

The free motion open toe quilting foot “O” is used for free motion quilting with zigzag or decorative stitches or for free motion quilting of straight lines on fabric with an uneven thickness. Various stitches can be sewn using free motion open toe quilting foot “O”. For details on the stitches that can be used, refer to “STITCH SETTING CHART” on page 206.

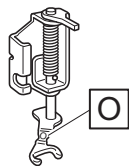

Free motion open toe quilting foot “O”

Memo

- In order to sew with a balanced tension, it may be necessary to adjust the upper thread tension (page 87). Test with a sample piece of quilting fabric.

1 Press  to set the machine to free motion sewing mode.

→ The key appears as , the quilting foot is raised to the necessary height, and then the feed dogs are lowered for free motion sewing.

2 Select a stitch.

Memo

- When stitch Q-01 or 1-31 is selected, free motion quilting foot “C” is indicated in the upper-left corner of the screen. When the other stitches are selected, free motion open toe quilting foot “O” is indicated in the screen.

3 Remove the presser foot holder (page 73).

4 Attach free motion open toe quilting foot “O” by positioning the pin of the quilting foot above the needle clamp screw and aligning the lower-left of the quilting foot and the presser bar.

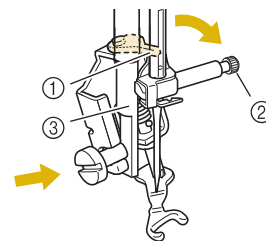

- ① Pin
- ② Needle clamp screw
- ③ Presser bar

Note

- Make sure that the quilting foot is not slanted.

5 Hold the quilting foot in place with your right hand, and tighten the presser foot holder screw using the multi-purpose screwdriver with your left hand.

* Use the multi-purpose screw driver setting the position to “1”. (page 23)

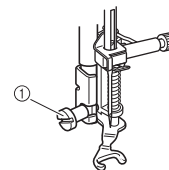

- ① Presser foot holder screw

CAUTION

- Be sure to securely tighten the screws with the included multi-purpose screwdriver. Otherwise, the needle may touch the quilting foot, causing it to bend or break.

- 6** Use both hands to stretch the fabric taut, and then move the fabric at a consistent pace in order to sew uniform stitches roughly 2.0-2.5 mm (approx. 1/16 - 3/32 inch) in length.

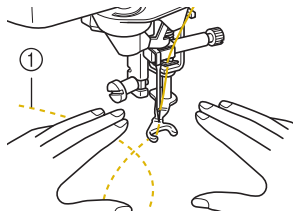

① Stitch

- 7** Press  to cancel the free motion sewing mode.

→ Rotate the handwheel toward you (counterclockwise) to raise the feed dogs.

Memo

- Do not be discouraged with your initial results. The technique requires practice.

■ Echo Quilting Using the Free Motion Echo Quilting Foot “E”

Sewing quilting lines at equal distances around a motif is called echo quilting. The quilting lines, which appear as ripples echoing away from the motif, are the distinguishing characteristic of this quilting style. Use the free motion echo quilting foot “E” for echo quilting. Using the measurement on the presser foot as a guide, sew around the motif at a fixed interval. We recommend attaching the foot controller and sewing at a consistent speed.

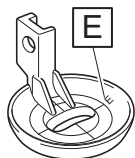

Free motion echo quilting foot “E” measurement

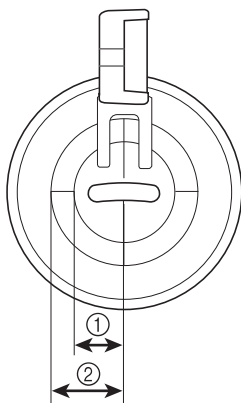

- ① 6.4 mm (approx. 1/4 inch)
② 9.5 mm (approx. 3/8 inch)

CAUTION



- With free motion quilting, control the feeding speed of the fabric to match the sewing speed. If the fabric is moved faster than the sewing speed, the needle may break or other damage may result.

Memo

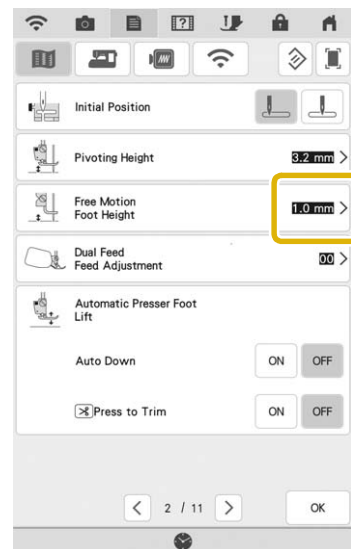
- When starting to sew, the internal sensor detects the thickness of the fabric, and the quilting foot is raised to the height specified in the machine settings screen. Press  to display “Free Motion Foot Height” of the settings screen (page 28). Touch the number to select the height that the quilting foot is raised above the fabric. Increase the setting, for example, when sewing very soft fabric, so that it is easier to sew.



- In order to sew with a balanced tension, it may be necessary to adjust the upper thread tension (page 87). Test with a sample piece of quilting fabric.

- Select .
- Press  to set the machine to free motion sewing mode.
 - The key appears as , the quilting foot is raised to the necessary height, then the feed dogs are lowered for free motion sewing.
- Follow the steps on page 72 to remove the presser foot.
- Remove the presser foot holder (page 73) and the screw.

5 Position the free motion echo quilting foot “E” on the left side of the presser bar with the holes in the quilting foot and presser bar aligned.

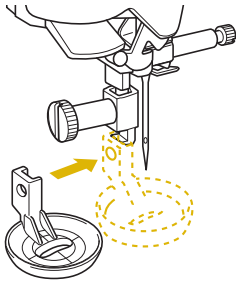

6 Tighten the screw with the included screwdriver (large).

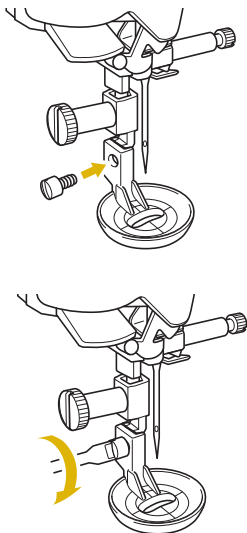

7 Using the measurement on the quilting foot as a guide, sew around the motif.

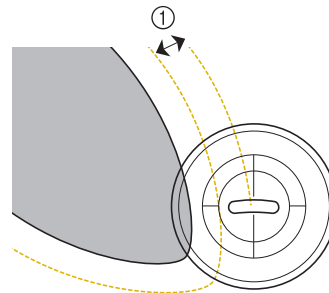
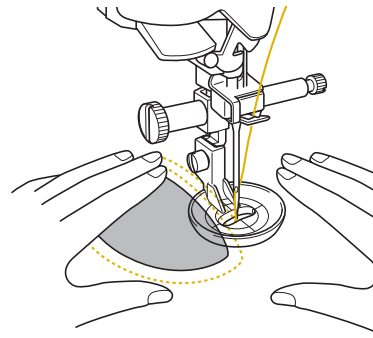

① 6.4 mm (approx. 1/4 inch)
Finished project

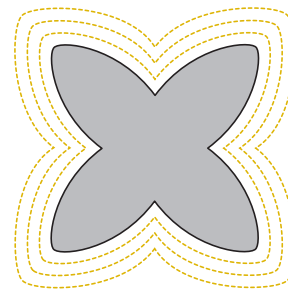

⚠ CAUTION

- Be sure to securely tighten the screws with the included screwdriver (large). Otherwise, the needle may touch the quilting foot, causing it to bend or break.

8 Press  to cancel the free motion sewing mode.

→ Rotate the handwheel toward you (counterclockwise) to raise the feed dogs.

Blind Hem Stitches

Secure the bottoms of skirts and pants with a blind hem. Two stitches are available for blind hem stitching.

Stitch	Stitch name	Presser foot
2-01	Blind hem stitch	
2-02	Blind hem stitch stretch	

Memo

- When the size of cylindrical pieces is too small to slide onto the arm or the length is too short, the fabric will not feed and desired results may not be achieved.

1 Turn the skirt or pants wrong side out.

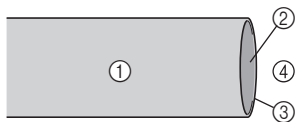

- ① Wrong side of fabric
- ② Right side of fabric
- ③ Edge of fabric
- ④ Bottom side

2 Fold the fabric along the desired edge of the hem, and press.

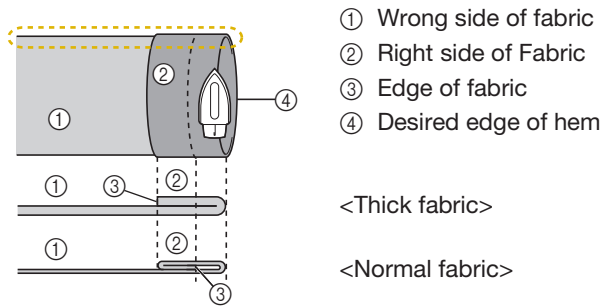

<Seen from the side>

3 Use a chalk to mark on the fabric about 5 mm (3/16 inch) from the edge of the fabric, and then baste it.

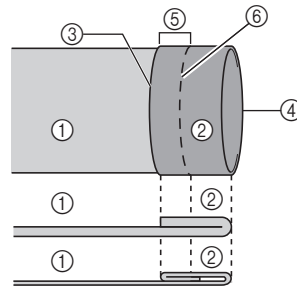

<Seen from the side>

- ① Wrong side of fabric
- ② Right side of fabric
- ③ Edge of fabric
- ④ Desired edge of hem
- ⑤ 5 mm (3/16 inch)
- ⑥ Basting

4 Fold back the fabric inside along the basting.

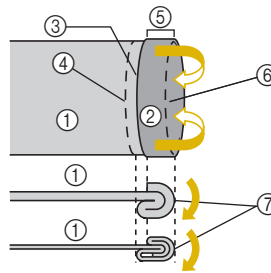

<Seen from the side>

- ① Wrong side of fabric
- ② Right side of fabric
- ③ Edge of fabric
- ④ Desired edge of hem
- ⑤ 5 mm (3/16 inch)
- ⑥ Basting
- ⑦ Basting point

5 Unfold the edge of fabric, and position the fabric with the wrong side facing up.

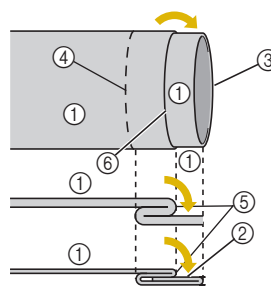

<Seen from the side>

- ① Wrong side of fabric
- ② Right side of fabric
- ③ Edge of fabric
- ④ Desired edge of hem
- ⑤ Basting point
- ⑥ Basting

6 Attach blind stitch foot "R".

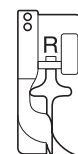

7 Select or .

- 8 Remove the flat bed attachment to use the free-arm.
- 9 Slide the item that you wish to sew onto the free arm, make sure that the fabric feeds correctly, and then start sewing.

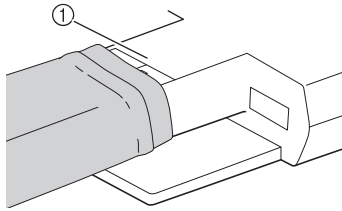

① Free arm

- 10 Position the fabric with the edge of the folded hem against the guide of the presser foot, and then lower the presser foot lever.

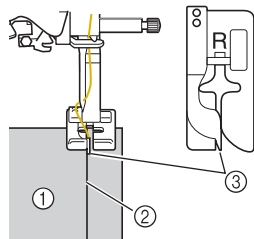

① Wrong side of fabric
 ② Fold of hem
 ③ Guide

- 11 Adjust the stitch width until the needle slightly catches the fold of the hem.

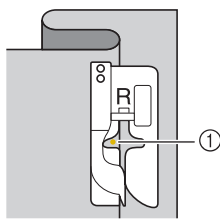

① Needle drop point
 When you change the needle drop point, raise the needle, and then change the stitch width.

<Stitch Width>

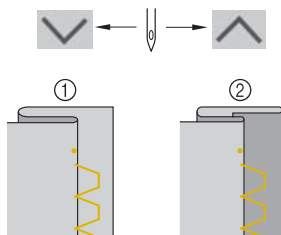

① Thick fabric
 ② Normal fabric

Memo

Blind hem stitches cannot be sewn if the left needle drop point does not catch the fold. If the needle catches too much of the fold, the fabric cannot be unfolded and the seam appearing on the right side of the fabric will be very large, leaving an unattractive finish. If you experience either of these cases, follow the instructions below to solve the problem.

■ If the Needle Catches Too Much of the Hem Fold

The needle is too far to the left.

Press to decrease the stitch width so that the needle slightly catches the fold of the hem.



<Thick fabric>

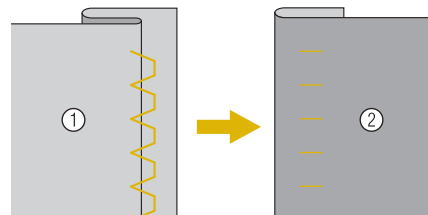

<Normal fabric>

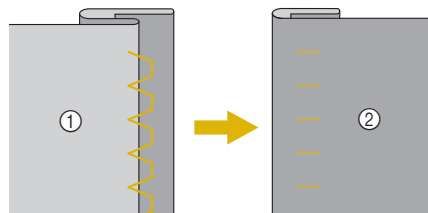

① Wrong side of fabric
 ② Right side of fabric

■ If the Needle does not Catch the Hem Fold

The needle is too far to the right.

Press to increase the stitch width so that the needle slightly catches the fold of the hem.



<Thick fabric>

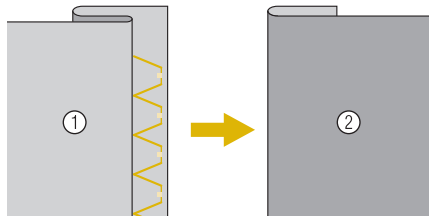

<Normal fabric>

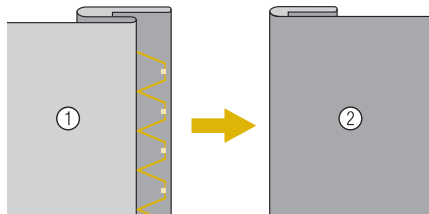

- ① Wrong side of fabric
② Right side of fabric

12 Sew with the fold of the hem against the presser foot guide.

13 Remove the basting stitching and reverse the fabric.

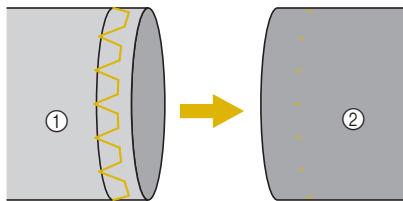

- ① Wrong side of fabric
② Right side of fabric

Appliqué

1 Use a temporary spray adhesive, fabric glue or a basting stitch to attach the appliqué to the fabric.

- * This will keep the fabric from moving during sewing.

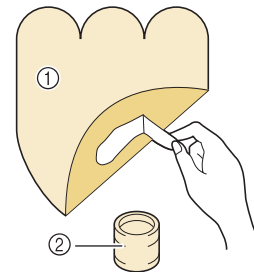

- ① Appliqué
② Fabric glue

2 Select  or .

- * Adjust the stitch length and width to correspond to the appliqué shape, size, and quality of material (page 85).



Memo

- For details on each stitch, refer to “STITCH SETTING CHART” on page 206.

3 Attach presser foot “J”. Check that the needle drops slightly off the edge of the appliqué, then start sewing.

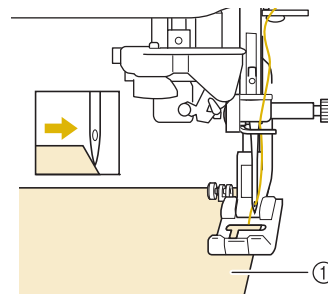

- ① Appliqué material

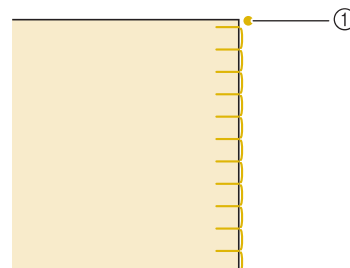

- ① Needle drop position

■ Appliqué Sharp Curves

Stop the machine with the needle in the fabric outside the appliqué. Raise the presser foot and turn the fabric a little bit at a time while sewing for an attractive finish to the seam.

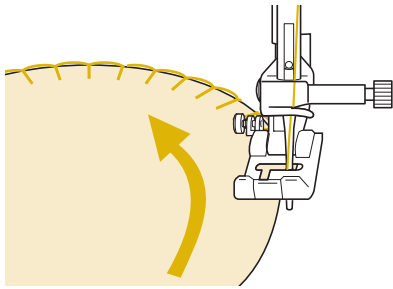

■ Appliqué Corners

Stop the machine with the needle in the right position of the outside (or inside) corner of the appliqué. Raise the presser foot and pivot the fabric to align the fabric edge. Lower the presser foot and continue stitching.

①

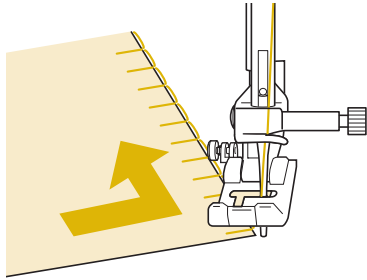

②

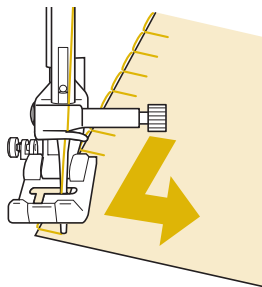

- ① Outside corner
- ② Inside corner

📖 Memo

- Placing a lightweight tear away stabilizer beneath the stitching area will improve the stitch placement along the edge of the appliqué fabric.

Shelltuck Stitches

Shelltuck stitches give an attractive appearance of shells along the curve of a collar. This stitch pattern can be used for edging the neckline or sleeves of dresses and blouses.

1 Select .

📖 Memo

- For details on each stitch, refer to “STITCH SETTING CHART” on page 206.

2 Increase the upper thread tension for an attractive scallop finish to the shelltuck stitches (page 87).

📖 Memo

- If the upper thread tension is too weak, the shelltuck stitches will not scallop.

3 To make rows of shell tuck stitches, fold the fabric in half along the bias.

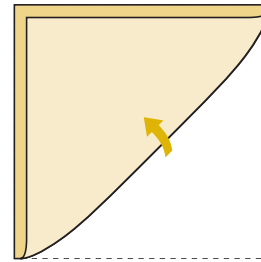

📖 Memo

- Use a thin fabric.

4 Attach presser foot “J”. Set the needle drop point slightly off the edge of the fabric, and start sewing.

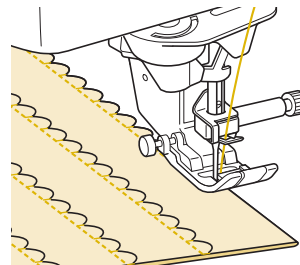

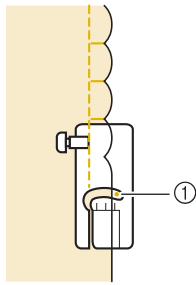

① Needle drop position

- 5** Unfold the fabric, and iron the tucks to one side.

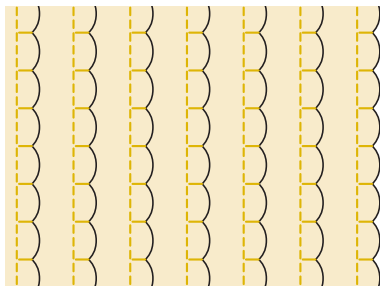

Memo

- To make shell tucks at the edge of a collar or neckline, follow the stitch pattern's instructions and then use this stitch to make a decorative finish on the collar or neckline.

Scallop Stitches

This wave-shaped satin stitch is called the scallop stitch. Use this stitch to decorate the edges of blouse collars and handkerchiefs or use it as a hem accent.



Memo

- A temporary spray adhesive may be necessary for lightweight fabrics. Test sew the fabric before sewing a project.

- 1** Select .



Memo

- For details on each stitch, refer to "STITCH SETTING CHART" on page 206.

- 2** Attach presser foot "N". Sew scallop stitches along the edge of the fabric.

* Do not sew directly on the edge of the fabric.

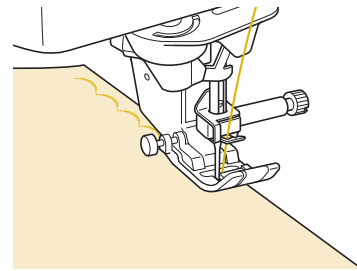

- 3** Trim along the seam, making sure not to cut the stitches.

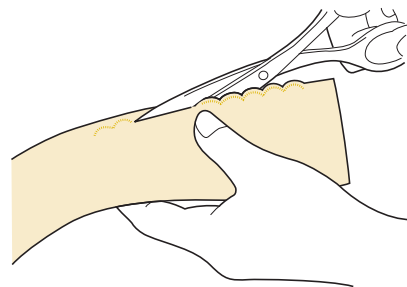

Memo

- Use a seam sealant to secure the edges of the scallop stitches.

Crazy Quilting

For a decorative look called "Crazy Quilting", the following stitches can be sewn on top of a pressed seam allowance.

- 1** Select a straight stitch and attach presser foot "J".
- 2** With the right sides facing each other, sew two pieces of fabric together, and then press open the seam allowance.

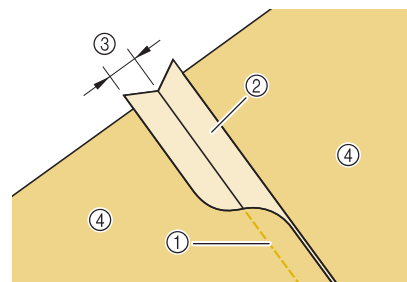

- ① Straight stitch
 ② Seam margins
 ③ 6.5 mm (approx. 1/4 inch)
 ④ Wrong side

3 Select a stitch for top stitching.

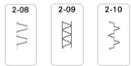

4 Place the fabric right side up in the machine, and center the presser foot over the seam when sewing.

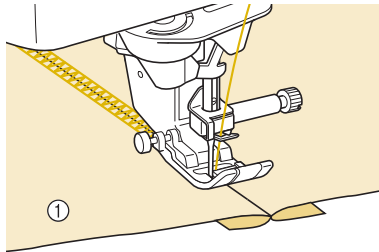

① Right side of fabric

Smocking Stitches

Use smocking stitches for decorative sewing on clothes, etc.

- 1** Select a straight stitch and attach presser foot "J".
- 2** Set the stitch length to 4.0 mm (approx. 5/32 inch) and loosen the upper thread tension to approximately 2.0 ("Setting the Stitch Length" on page 86 and "Setting the Thread Tension" on page 87).
- 3** Pull the bobbin and upper threads out by 50 mm (approx. 2 inches).
- 4** Sew the seams, leaving approximately 10 mm (approx. 3/8 inch) between the seams, then trim excess thread, leaving 50 mm (approx. 2 inches).

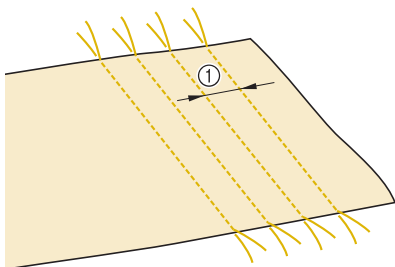

① Approximately 10 mm (approx. 3/8 inch)

5 Pull the bobbin threads to obtain the desired amount of gather, and then smooth the gathers by ironing them.

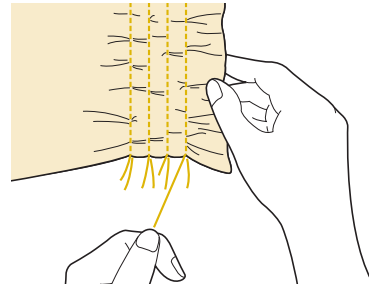

6 Select  or .



Memo

- For details on each stitch, refer to "STITCH SETTING CHART" on page 206.

7 Sew the spaces between the straight seams.

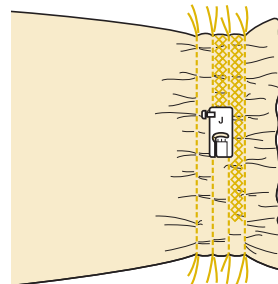

8 Pull out the straight stitch threads.

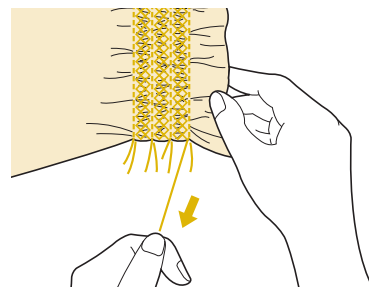

Fagoting

When there is a space between two fabrics with thread sewn over the space to join the fabrics together, it is called fagoting. Use this stitch when sewing blouses or children's clothes.

- 1 Baste two pieces of fabric onto thin paper, leaving a space of 4 mm (approx. 3/16 inch) between the fabrics.**

* If you draw a line down the middle of the thin paper or water soluble stabilizer, sewing is easier.

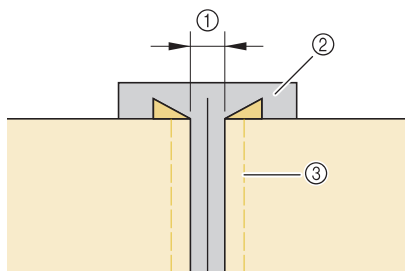

- ① 4.0 mm (approx. 3/16 inch)
- ② Paper
- ③ Basting stitches

- 2 Select**  **or** .

Memo

- For details on each stitch, refer to "STITCH SETTING CHART" on page 206.

- 3 Attach presser foot "J". Align the center of the presser foot with the middle of the space between the fabrics and begin sewing.**

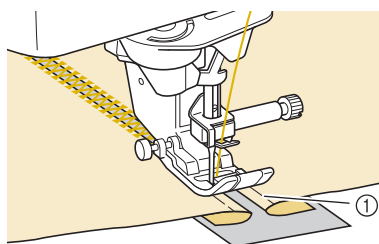

- ① Basting stitches

Memo



- Use a thick thread.

- 4 When sewing is finished, gently tear the paper away.**

Tape or Elastic Attaching

- 1 Select a straight stitch and attach presser foot "J".**
- 2 Set the stitch length to 4.0 mm (approx. 3/16 inch), and loosen the upper thread tension to 2.0 ("Setting the Stitch Length" on page 86 and "Setting the Thread Tension" on page 87).**

Memo

- Be sure that neither automatic reinforcement  nor automatic thread cutting  is selected.

- 3 Sew two rows of straight stitches on the right side of the fabric, then pull the bobbin thread to create the necessary gather.**

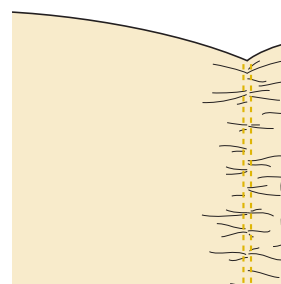

Memo

- Before sewing the straight stitch, rotate the handwheel toward you (counterclockwise) and pull up the bobbin thread. Holding the top and bobbin thread, pull a length of thread out from the rear of the machine. (Be sure that the presser foot is raised.)

- 4 Place the tape over the gather, and hold it in place with basting pins.**

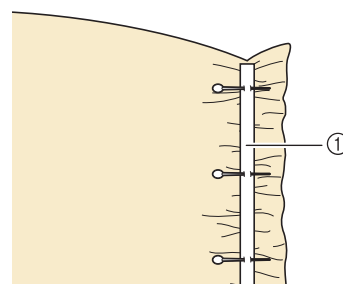

- ① Tape

5 Select  or .

 **Memo**

- For details on each stitch, refer to “STITCH SETTING CHART” on page 206.

6 Sew over the tape (or elastic).

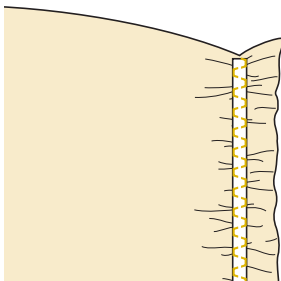
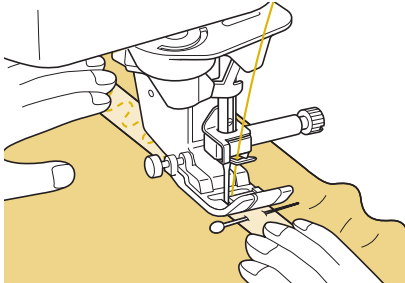

 **CAUTION**

- Be sure the needle does not strike a basting pin, or any other objects, during sewing. The thread could tangle or the needle could break, causing injury.

7 Pull out the straight stitch threads.

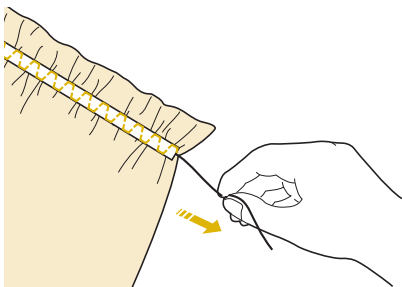

Heirloom

Hemstitching (1) (Daisy Stitch)

Use for sewing tablecloths, decorative hems, and decorative stitching on shirt fronts.

 **Memo**

- Use a light to medium weight homespun fabric with a little stiffness.

1 Insert a type 130/705H, size 100/16 Wing needle.

- * This specialty sewing needle is not furnished with your machine. Must be purchased separately.

 **CAUTION**

- The “Automatic Threading” button cannot be used. Thread the wing needle by hand, from front to back. Using the “Automatic Threading” button may result in damage to the machine.
- A more attractive finish can be obtained if you use a “130/705H Wing” needle when sewing these stitch patterns. If using a wing needle and the stitch width has been set manually, check that the needle will not touch the presser foot by carefully rotating the handwheel toward you (counterclockwise) before starting to sew.

2 Select a stitch and attach presser foot “N”.

- * Select any stitch between 3-01 and 3-25.

 **Memo**

- For details on each stitch, refer to “STITCH SETTING CHART” on page 206.

3 Start sewing.

Example: Illustration of finished product

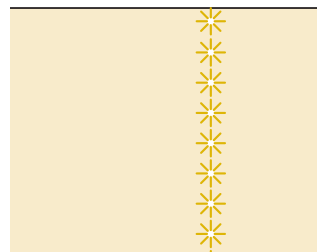

■ Hemstitching (2) (Drawn Work (1))

- 1** Pull out several threads from one area on a piece of fabric to open the area.

* Pull out 5 or 6 threads to leave a 3 mm (approx. 1/8 inch) area open.

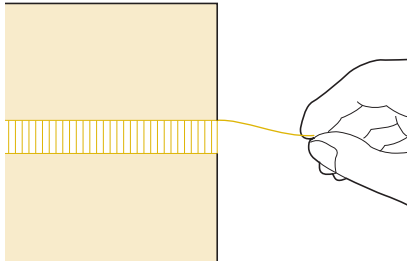

Memo

- Loosely woven fabrics work best for this.

- 2** Select .

Memo

- For details on each stitch, refer to “STITCH SETTING CHART” on page 206.

- 3** Attach presser foot “N”. With the right side of the fabric facing up, sew one edge of the open area.

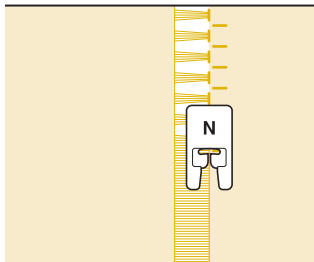

- 4** Press  to create a mirror image of the stitch.

- 5** Match beginning needle drop points on the opposite edge of the open area to keep the stitching symmetrical.

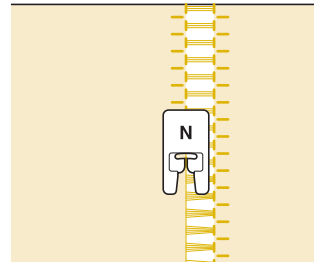

■ Hemstitching (3) (Drawn Work (2))

- 1** Pull out several threads from both sides of the 4 mm (approx. 3/16 inch) area which are not yet open.

* Pull out four threads, leave five threads, and then pull out four threads. The width of five threads is approximately 4 mm (approx. 3/16 inch) or less.

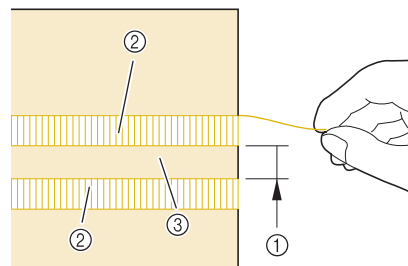

- ① Approx. 4 mm (approx. 3/16 inch) or less
- ② Four threads (pull out)
- ③ Five threads (leave)

- 2** Select .

Memo

- For details on each stitch, refer to “STITCH SETTING CHART” on page 206.

- 3** Sew the decorative stitch in the center of the five threads created above.

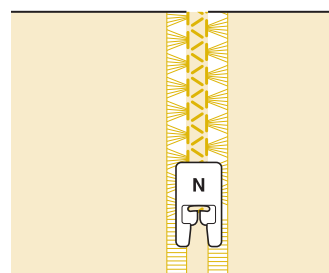

Memo

- A wing needle can be used for Hemstitching (3).

Basting

- 1 Select  and attach presser foot “J”.
- 2 Keep pressing the “Reverse Stitch” button or the “Reinforcement Stitch” button to sew 4 stitches of reinforcement stitches, then press “Start/Stop” button to continue sewing.

Memo

- When you use the basting stitch for gathering, do not use a reinforcement stitch at the beginning; you should lift the presser foot, rotate the handwheel toward you (counterclockwise), pull up the bobbin thread and pull a length of top and bobbin thread out from the rear of the machine.
- Stitching will be sewn with a length of 5 mm (approx. 3/16 inch).

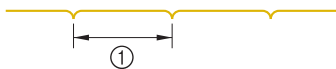

① 5 mm (approx. 3/16 inch)

- 3 Sew while keeping the fabric straight.

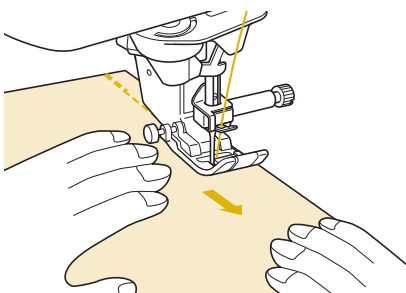

- 4 End the basting with reinforcement stitches.

Free-Motion Basting

When the feed dogs are lowered, basting can be sewn while freely moving the fabric.

- 1 Press .

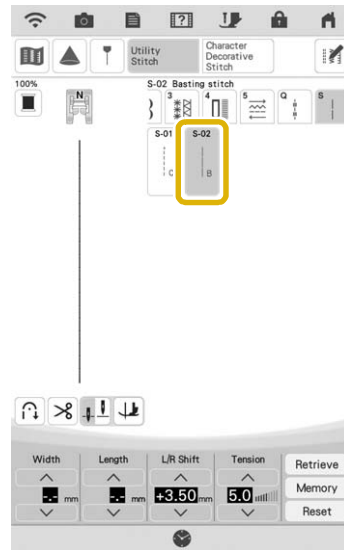

→ The presser foot is raised to the height necessary for free-motion sewing, and the feed dogs are lowered.

- 2 Keep pressing the “Reverse Stitch” button or the “Reinforcement Stitch” button to sew 4 stitches of reinforcement stitches, then press “Start/Stop” button to continue sewing.

- 3 Press the “Start/Stop” button to start sewing.

Sew while moving the fabric when the needle is raised.

Memo

- If the side pedal of the multi-function foot controller (sold separately) is set to “Single Stitch”, basting can be sewn by using the side pedal to sew each single stitch. For details on specifying settings for the multi-function foot controller, refer to “Specifying the Multi-Function Foot Controller (Sold Separately)” on page 33.
- The green light on the right of the “Reinforcement Stitch” button lights up while reinforcement or reverse stitching.
- The sewing speed is limited up to 100 spm.

- 4 End the basting with reinforcement stitches.

One-step Buttonholes

With one-step buttonholes, you can make buttonholes appropriate to the size of your button.

CAUTION

- When attaching and removing buttonhole foot “A+”, do not apply excessive force to the presser foot, otherwise it may be damaged. In addition, be careful not to hit the needle when attaching and removing buttonhole foot “A+”, otherwise the needle may break.

Note

- Before attaching the presser foot, check that there is enough thread in the bobbin.
- When the presser foot is attached, the compartment of the flat bed attachment cannot be opened. Be sure to first remove any necessary accessories.
- Sew trial stitches on fabric that is the same as that used in your project, referring to “Fabric/Thread/Needle Combinations” on page 71.
- The built-in camera detects the position of buttonhole foot “A+”. Do not touch the camera. (Refer to “NAMES OF MACHINE PARTS AND THEIR FUNCTIONS” on page 12.)
- Do not peel the “A+” sticker off buttonhole foot “A+” or cover the sticker with the upper thread, etc., otherwise the camera cannot detect the presser foot or buttonholes cannot be sewn.

Stitch	Stitch name	Presser foot
4-01	Narrow rounded buttonhole	A+
4-02	Wide round ended buttonhole	A+
4-03	Tapered round ended buttonhole	A+
4-04	Round ended buttonhole	A+
4-05	Round ended buttonhole	A+
4-06	Round double ended buttonhole	A+
4-07	Narrow squared buttonhole	A+

Stitch	Stitch name	Presser foot
4-08	Wide squared buttonhole	A+
4-09	Squared buttonhole	A+
4-10	Stretch buttonhole	A+
4-11	Heirloom buttonhole	A+
4-12	Bound buttonhole	A+
4-13	Keyhole buttonhole	A+
4-14	Tapered keyhole buttonhole	A+
4-15	Keyhole buttonhole	A+

One-step buttonholes are sewn from the front of the presser foot to the back, as shown below.

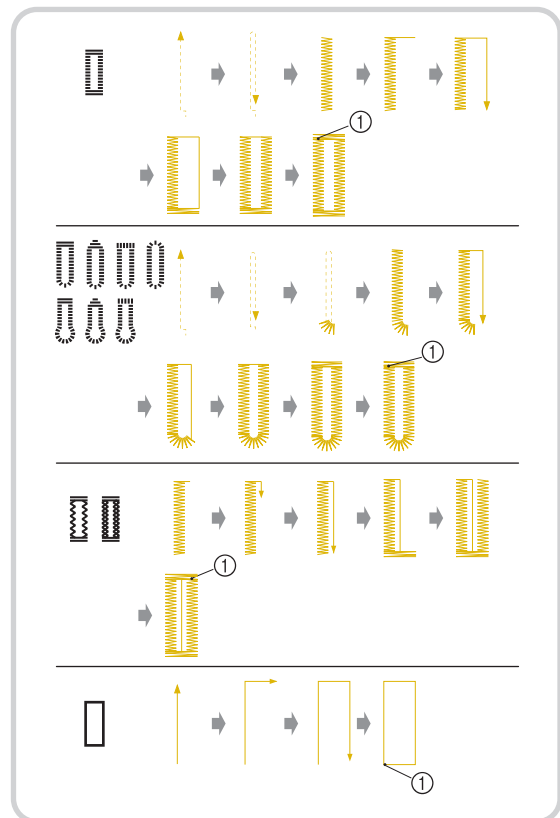

① Reinforcement stitching

- 1 Select a buttonhole stitch, and attach buttonhole foot “A+”.

2 Mark the position and length of the buttonhole on the fabric.

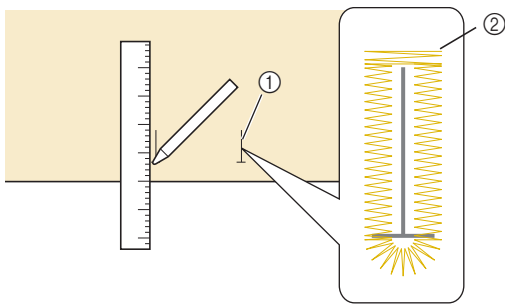

- ① Marks on fabric
- ② Buttonhole sewing



Memo

- The maximum buttonhole length is about 47 mm (approx. 1-3/4 inches) (diameter + thickness of the button).

3 Pull out the button holder plate on the presser foot, and insert the button that will be put through the buttonhole. Then tighten the button holder plate around the button.

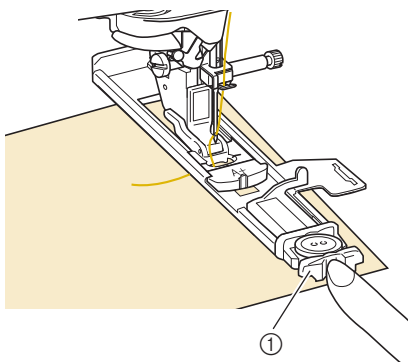

- ① Button holder plate



Memo

- The size of the buttonhole is determined by the size of the button in the button holder plate.

4 Align the presser foot with the mark on the fabric, and lower the presser foot.

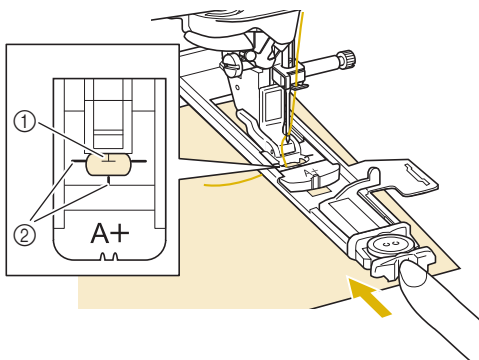

- ① Mark on the fabric
- ② Marks on the presser foot



Note

- Pass the thread underneath the presser foot.
- Slide the outside frame of the buttonhole foot backward as far as possible as shown in the illustration, making sure that there is no gap behind the part of the foot marked "A+". If the buttonhole foot is not slid back as far as possible, the buttonhole will not be sewn at the correct size.

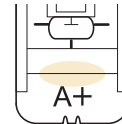

5 Gently hold the end of the upper thread, and then start sewing.

- * Feed the fabric carefully by hand while the buttonhole is sewn.

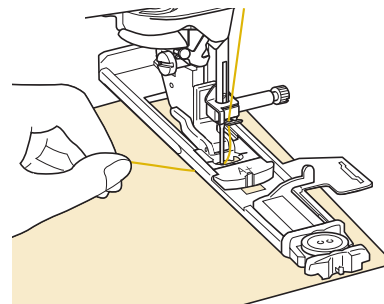

- Once sewing is completed, the machine automatically sews reinforcement stitches, and then stops.



Memo

- If automatic thread cutting is turned on before you start sewing, both threads are automatically cut after the reinforcement stitches are sewn. If the fabric does not feed (for example, because it is too thick), increase the stitch length setting.

- 6** Insert a pin along the inside of one of the bar tacks, and then insert the seam ripper into the center of the buttonhole and cut towards the pin.

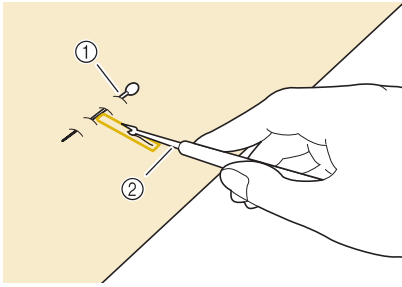

- ① Basting pin
② Seam ripper

⚠ CAUTION

- When using the seam ripper to open the buttonhole, do not put your hand or finger in the path of the ripper. The ripper may slip and cause injury. Do not use the seam ripper in any other way than how it is intended.

📖 Memo

- For keyhole buttonholes, use the eyelet punch to make a hole in the rounded end of the buttonhole. Then insert a pin along the inside of one of the bar tacks, insert a seam ripper into the hole made with the eyelet punch, and cut towards the pin.

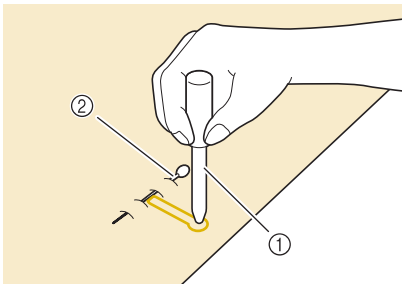



- ① Eyelet punch
② Basting pin

■ Sewing Stretch Fabrics



Note

- Attach stabilizer material to the back of stretch fabrics to prevent them from stretching.

When sewing on stretch fabric with  or , sew the buttonhole stitches over a gimp thread.

- 1** Hook the gimp thread onto the back of presser foot "A+". Insert the ends into the grooves at the front of the presser foot, and then temporarily tie them there.

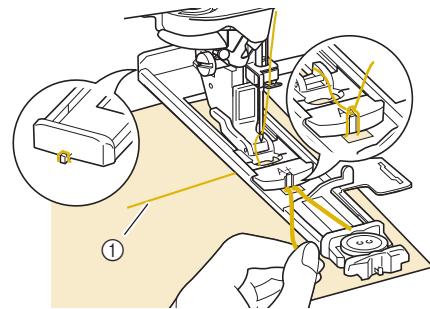

- ① Upper thread

- 2** Lower the presser foot and start sewing.

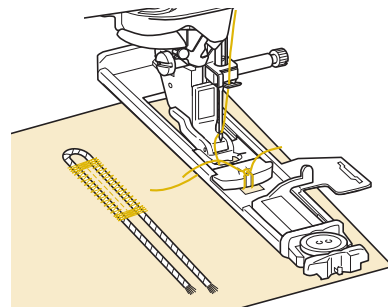

📖 Memo

- Set the width of the satin stitches to the width of the gimp thread, and set the buttonhole width to be 2-3 times the width of the gimp thread.

- 3** Once sewing is completed, gently pull the gimp thread to remove any slack, and trim off any excess.

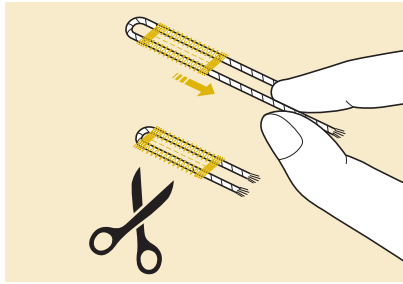

Memo

- After using the seam ripper to cut open the threads over the buttonhole, trim off the threads.

■ Odd Shaped Buttons/Buttons that do Not Fit into the Button Holder Plate

Use the markings on the presser foot scale to set the size of the buttonhole. One mark on the presser foot scale equals 5 mm (approx. 3/16 inch). Add the button diameter and thickness together, and then set the plate at the calculated value.

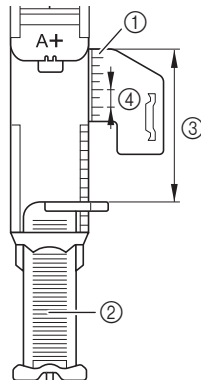

- ① Presser foot scale
- ② Button holder plate
- ③ Completed measurement of diameter + thickness
- ④ 5 mm (approx. 3/16 inch)

Memo

- Example) For a button with a diameter of 15 mm (about 9/16 inch) and thickness of 10 mm (about 3/8 inch), align the scale with 25 mm (about 1 inch), or specify 25 mm in the screen.

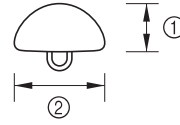

- ① 10 mm (approx. 3/8 inch)
- ② 15 mm (approx. 9/16 inch)



■ Sewing Thick Fabrics

Place a piece of folded fabric or cardboard beside the fabric being sewn to level the buttonhole foot and allow for easier and even feeding.

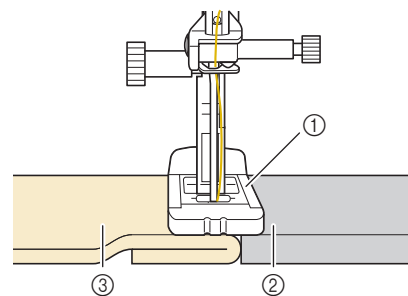

- ① Presser foot
- ② Thick paper
- ③ Fabric

Memo

- If automatic thread cutting is turned on before you start sewing, both threads are automatically cut after the reinforcement stitches are sewn. If the fabric does not feed (for example, because it is too thick), increase the stitch length setting.

■ Sewing Thick Seams or Fabric That Cannot Be Correctly Fed

Attach the buttonhole stabilizer, and then feed the fabric between the stabilizer and the presser foot.

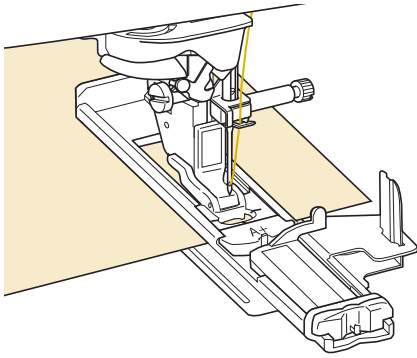









Four-step Buttonholes

You can sew 4-step buttonholes using the following 4 stitches together. You can sew any desired length for the buttonhole when using 4-step buttonholes. 4-step buttonholes are a good option when attaching oversize buttons.



Note

- When changing the stitch settings, make sure that all stitch settings are changed to match.

Stitch	Stitch name	Presser foot
	4 steps buttonhole 1	
	4 steps buttonhole 2	
	4 steps buttonhole 3	
	4 steps buttonhole 4	

Four-step buttonholes are sewn as shown below.

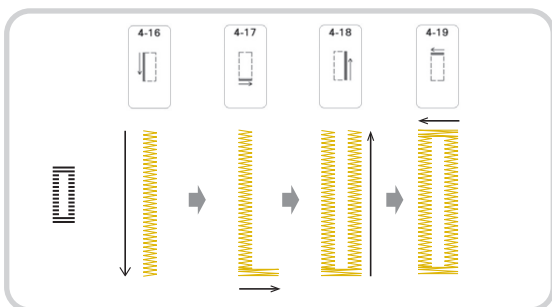

- 1 Mark the position and length of the buttonhole on the fabric.

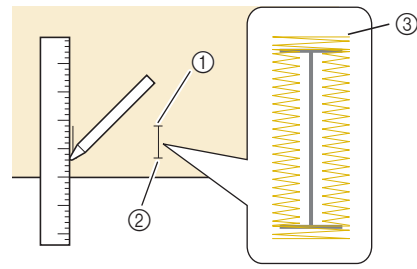

- ① Starting point
- ② End point
- ③ Buttonhole sewing

- 2 Attach monogramming foot "N", and select

stitch  to sew the left side of the buttonhole.

- 3 Press the "Start/Stop" button to start sewing.

- 4 Sew the desired length for the buttonhole and press the "Start/Stop" button again.

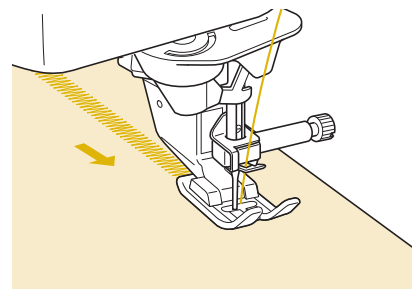

- 5 Select stitch  to sew the bar tack and press the "Start/Stop" button.

→ The machine will automatically stop after sewing the bar tack.

- 6 Select stitch  to sew the right side of the buttonhole, and press the "Start/Stop" button to begin sewing.

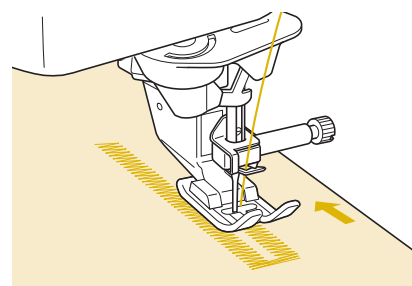

7 Sew the right side of the buttonhole and press the “Start/Stop” button again.

* Sew the right side of the buttonhole the same length as the left.

8 Select stitch  to sew the bar tack and then press the “Start/Stop” button.



→ The machine will automatically sew off the bar tack tie and stop when the bar tack is complete.

9 Raise the presser foot and remove the fabric.

10 Refer to page 143 to open the buttonhole.

Darning

Use darning stitches for mending and other applications.

Stitch	Stitch name	Presser foot
4-20	Darning	
4-21	Darning	

Darning is performed by sewing from the front of the presser foot to the back as shown below.

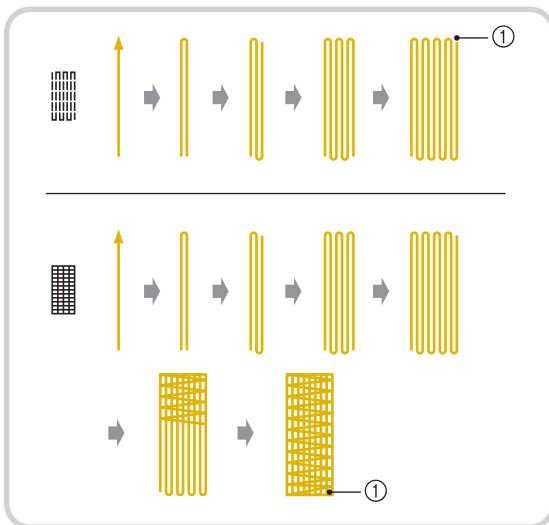

① Reinforcement stitches

1 Select a stitch, and attach buttonhole foot “A+”.

2 Set the scale to the desired length of the darning.

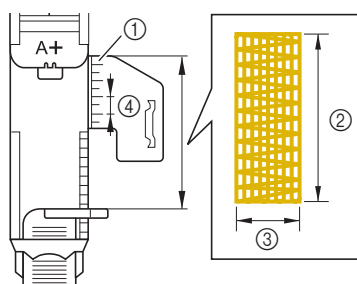

- ① Presser foot scale
- ② Completed length measurement
- ③ Width 7 mm (approx. 1/4 inch)
- ④ 5 mm (approx. 3/16 inch)

Memo

- The maximum length for darning is 50 mm (approx. 1-31/32 inches).

3 Check that the needle drops at the desired position and lower the presser foot, making sure the upper thread passes underneath the buttonhole foot.

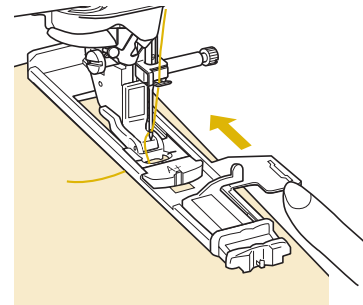

Note

- Pass the thread underneath the presser foot.
- Set the presser foot so that there is no gap behind the section marked with an “A+” (the shaded area in the illustration below). If there is a gap, the size of the darning will not be correct.

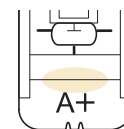

4 Gently hold the end of the upper thread, and then press the “Start/Stop” button to start the machine.

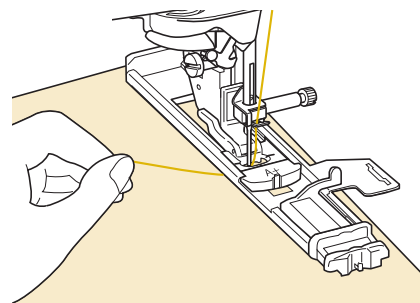

→ Once sewing is completed, the machine automatically sews reinforcement stitches, and then stops.

Memo

- If automatic thread cutting is turned on before you start sewing, both threads are automatically cut after the reinforcement stitches are sewn. If the fabric does not feed (for example, because it is too thick), increase the stitch length setting.

Bar Tacks

Use bar tacks to reinforce areas that will be subject to strain, such as pocket corners.

Stitch	Stitch name	Presser foot
4-22	Bar tack	A+

1 Select .

2 Attach buttonhole foot “A+” and set the scale to the length of the bar tack you wish to sew.

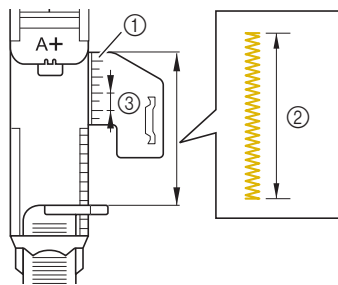

- ① Presser foot scale
- ② Completed length measurement
- ③ 5 mm (approx. 3/16 inch)

Memo

- Bar tacks can be between 10 mm (approx. 25/64 inch) and 50 mm (approx. 1-31/32 inches).

3 Set the fabric so that the pocket moves toward you during sewing.

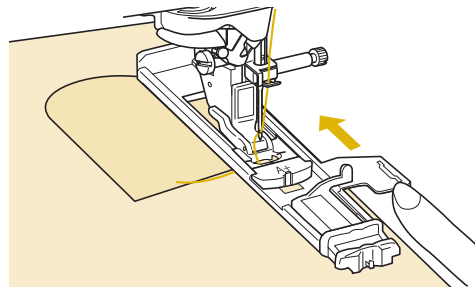

Note

- Pass the thread underneath the presser foot.
- Slide the outside frame of the buttonhole foot backward as far as possible as shown in the illustration, making sure that there is no gap behind the part of the foot marked “A+”. If the buttonhole foot is not slid back as far as possible, the bar tack will not be sewn to the correct size.

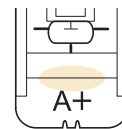

4 Check the first needle drop point and lower the presser foot.

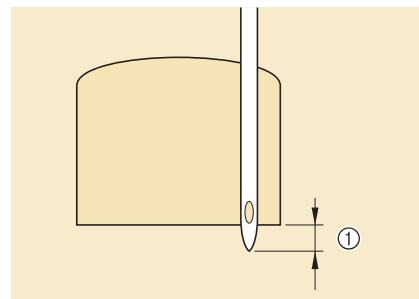

- ① 2 mm (approx. 1/16 inch)

5 Gently hold the end of the upper thread and begin sewing.

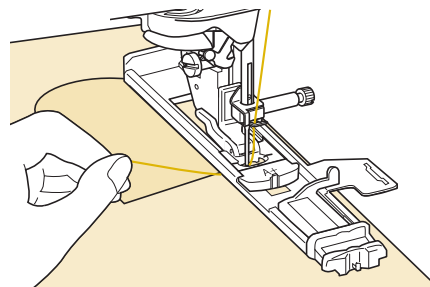

→ When sewing is completed, the machine will sew reinforcement stitches and stop automatically.

Button Sewing

Buttons with 2 or 4 holes can be attached, using the machine.

Stitch	Stitch name	Presser foot
	Button sewing	



Note

- Do not use the automatic thread cutting function when sewing buttons. Otherwise, you will lose the thread ends.

1 Select .

→ The feed dogs are lowered automatically.

2 Raise the presser foot.

3 Attach button sewing foot “M”, slide the button along the metal plate and into the presser foot, and lower the presser foot.

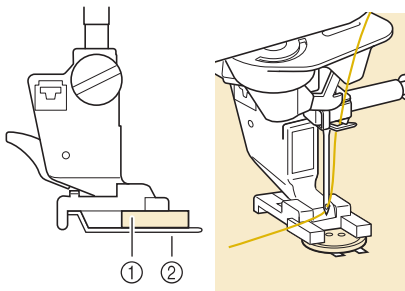

- ① Button
- ② Metal plate

4 Rotate the handwheel toward you (counterclockwise) to check that the needle goes into each hole correctly.

- * If the needle does not reach the holes on the left side, adjust the stitch width.
- * To attach the button more securely, repeat the process.

5 Gently hold the end of the upper thread and start sewing.

→ The machine stops automatically when sewing is finished.

⚠ CAUTION

- Make sure the needle does not strike the button during sewing. The needle may break and cause injury.

6 From the wrong side of the fabric, pull the end of the bobbin thread to pull the upper thread through to the wrong side of the fabric. Tie the two thread ends together and cut the threads.

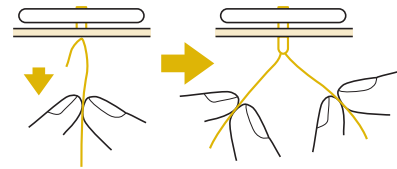

7 After the button is attached, select another stitch and rotate the handwheel toward you (counterclockwise) to raise the feed dogs.

■ Attaching 4 Hole Buttons

Sew the two holes closest to you. Then raise the presser foot and move the fabric so that the needle goes into the next two holes, and sew them in the same way.

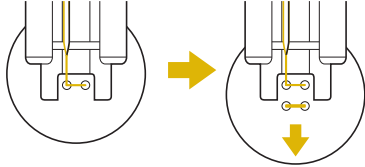

■ Attaching a Shank to the Button

1 Pull the shank lever toward you before sewing.

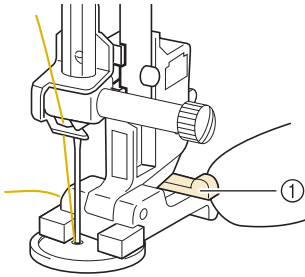

① Shank lever

2 Pull the two ends of the upper thread between the button and the fabric, wind them around the shank, and then tie them firmly together.

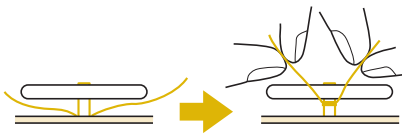

3 Tie the ends of the bobbin thread from the beginning and end of sewing together on the wrong side of the fabric.



Note

• When sewing is completed, be sure to select the other stitch and rotate the handwheel toward you (counterclockwise) to raise the feed dogs.

4 Cut off any excess thread.

Eyelet

Use this stitch for making belt holes and other similar applications.

Stitch	Stitch name	Presser foot
4-24	Eyelet	
4-25	Star eyelet	

1 Select or .

2 Use in either the stitch width display or the stitch length display to choose the size of the eyelet.



- ① Large 7 mm (approx. 9/32 inch)
- ② Medium 6 mm (approx. 15/64 inch)
- ③ Small 5 mm (approx. 13/64 inch)



Note

• Only one size is available for .

3 Attach monogramming foot “N”, then rotate the handwheel toward you (counterclockwise) to check the needle drop position.

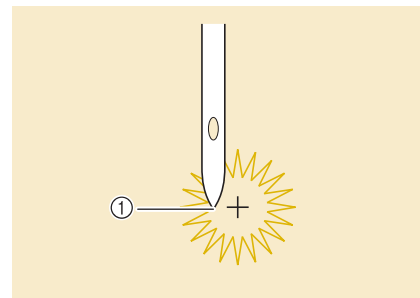

① Needle drop position

4 Lower the presser foot and start sewing.

→ When sewing is finished, the machine sews reinforcement stitches and stops automatically.

**Note**

- If the stitch pattern comes out poorly, make adjustments to “SEWING STITCH PATTERNS” on page 163.

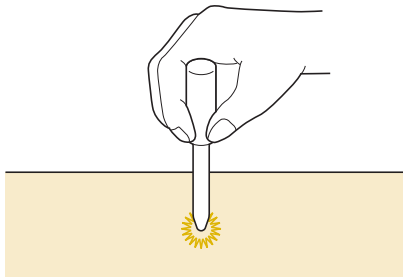
5 Use the eyelet punch to make a hole in the center of the stitching.

Multi-directional Sewing (Straight Stitch and Zigzag Stitch)

Use these stitch patterns to attach patches or emblems to pant legs, shirt sleeves, etc.

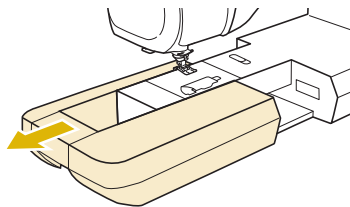
1 Remove the flat bed attachment to use the free-arm.**Memo**

- Insert the tubular piece of fabric onto the free-arm, and then sew in the order shown in the illustration.

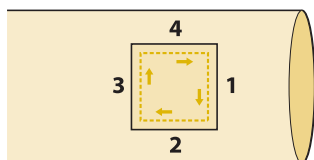
**2 Select  and attach monogramming foot “N”.****Memo**

- For details on each stitch, refer to “STITCH SETTING CHART” on page 206.

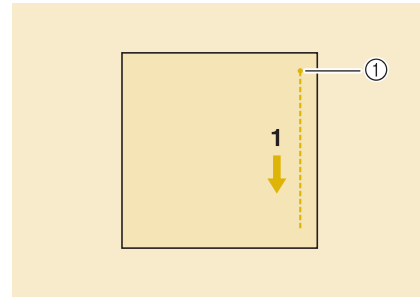
3 Set the needle in the fabric at the sewing start point, and sew seam “1” as shown.

① Start Point

4 Select  and sew seam “2” as shown.

- * The fabric will move sideways, guide the fabric by hand to keep sewing straight.

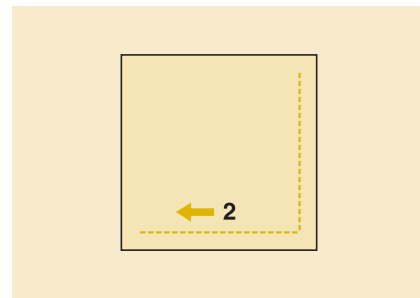
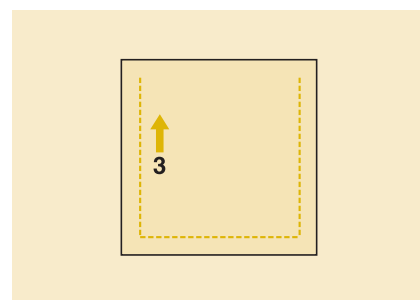
**5 Select  and sew seam “3” as shown.**

→ The fabric feeds forward while stitching backward.

6 Select  and sew seam "4" as shown.

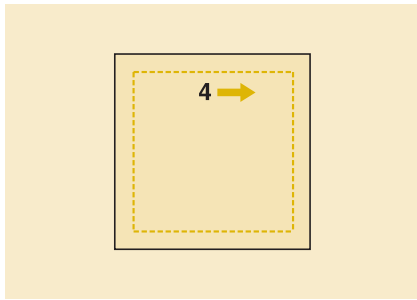

→ The seam will be connected to the starting point of seam 1.

Zipper Insertion

Centered Zipper

Use for bags and other such applications.

1 Select .



Memo

- For details on each stitch, refer to "STITCH SETTING CHART" on page 206.



Note

- Make sure you sew using the middle needle position.

2 Attach presser foot "J" and sew straight stitches up to the zipper opening. Change to a basting stitch (page 140) and sew to the top of the fabric.

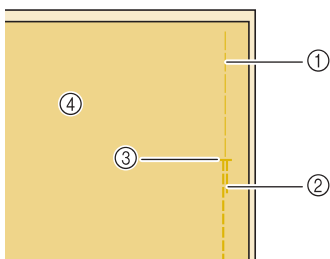

- ① Basting stitches
- ② Reverse stitches
- ③ End of zipper opening
- ④ Wrong side

3 Press the seam allowance open and attach the zipper with a basting stitch in the middle of each side of the zipper tape.

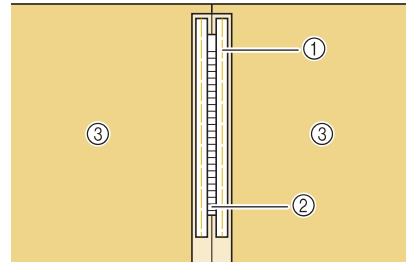

- ① Basting stitches
- ② Zipper
- ③ Wrong side

4 Remove presser foot "J". Align the right side of the pin in zipper foot "I" with the presser foot holder, and attach the zipper foot.

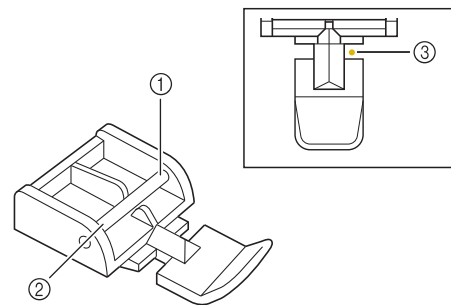

- ① Right
- ② Left
- ③ Needle drop position

⚠ CAUTION

- When using zipper foot "I", make sure the straight stitch, middle needle position is selected. Rotate the handwheel toward you (counterclockwise) to make sure the needle does not strike the presser foot. If another stitch is selected, the needle will strike the presser foot, causing the needle to break and possibly causing injury.

- 5** Topstitch 7 to 10 mm (approx. 1/4 to 3/8 inch) from the seamed edge of the fabric, then remove the basting.

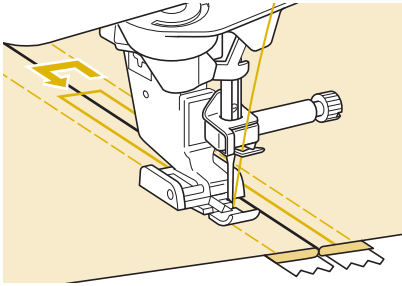

⚠ CAUTION

- Make sure the needle does not strike the zipper during sewing. If the needle strikes the zipper, the needle may break, leading to injury.

■ Inserting a Side Zipper

Use for side zippers in skirts or dresses.

- 1** Select .



Note

- Make sure you sew using the middle needle position.

- 2** Attach presser foot “J” and sew straight stitches up to the zipper opening. Change to a basting stitch and sew to the top of the fabric.

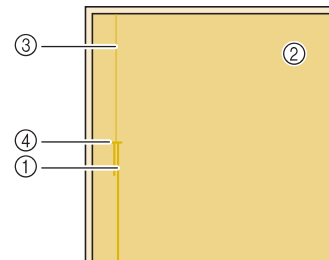

- ① Reverse stitches
- ② Wrong side of fabric
- ③ Basting stitches
- ④ End of zipper opening

- 3** Press the seam allowance open and align the folded hem along the teeth of the zipper, while maintaining 3 mm (approx. 1/8 inch) of sewing space.

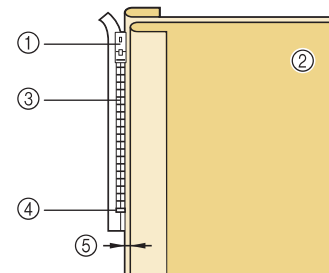

- ① Zipper pull tab
- ② Wrong side of fabric
- ③ Zipper teeth
- ④ End of zipper opening
- ⑤ 3 mm (approx. 1/8 inch)

- 4** Remove presser foot “J”.

- 5** Align the right side of the pin in zipper foot "1" with the presser foot holder, and attach the presser foot.

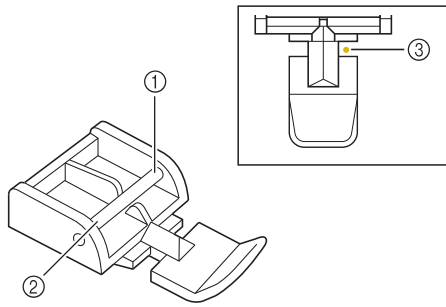

- ① Right
- ② Left
- ③ Needle drop position

⚠ CAUTION

- When using zipper foot "1", make sure the straight stitch, middle needle position is selected. Rotate the handwheel toward you (counterclockwise) to make sure the needle does not strike the presser foot. If another stitch is selected, the needle will strike the presser foot, causing the needle to break and possibly causing injury.

- 6** Set the presser foot in the 3 mm (approx. 1/8 inch) margin.
- 7** Starting from the end of the zipper opening, sew to a point about 50 mm (approx. 2 inches) from the edge of the fabric, then stop the machine.
- 8** Pull down the zipper slider, then continue sewing to the edge of the fabric.

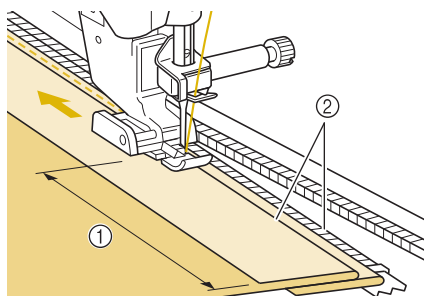

- ① 50 mm (approx. 2 inches)
- ② 3 mm (approx. 1/8 inch)

⚠ CAUTION

- Make sure the needle does not strike the zipper during sewing. If the needle strikes the zipper, the needle may break, leading to injury.

- 9** Close the zipper, turn the fabric over, and sew a basting stitch.

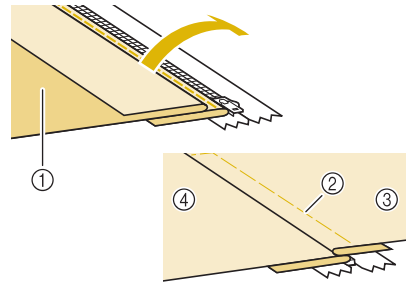

- ① Front of the skirt (wrong side of fabric)
- ② Basting stitches
- ③ Front of the skirt (right side of fabric)
- ④ Back of the skirt (right side of fabric)

- 10** Remove the presser foot, and reattach it so that the left side of the pin is attached to the presser foot holder.

- * When sewing the left side of the zipper, the needle should drop on the right side of the presser foot. When sewing the right side of the zipper, the needle should drop on the left side of the presser foot.

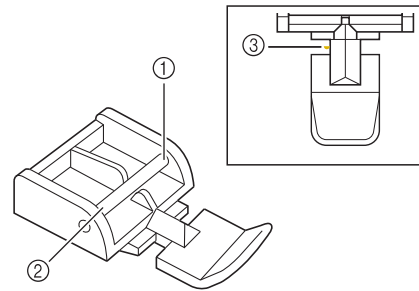

- ① Right
- ② Left
- ③ Needle drop position

- 11** Set the fabric so that the left edge of the presser foot touches the edge of the zipper teeth.
- 12** Sew reverse stitches at the top of the zipper, then continue sewing.
- 13** Stop sewing about 50 mm (approx. 2 inches) from the edge of the fabric, leave the needle in the fabric, and remove the basting stitches.

14 Open the zipper and sew the rest of the seam.

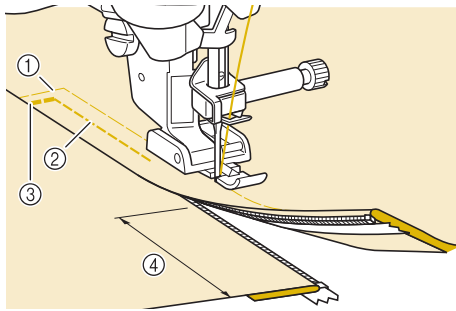



- ① Basting stitches
- ② 7 to 10 mm (approx. 1/4 inch to 3/8 inch)
- ③ Reverse stitches
- ④ 50 mm (approx. 2 inches)



Chapter **4**

Character/Decorative Stitches

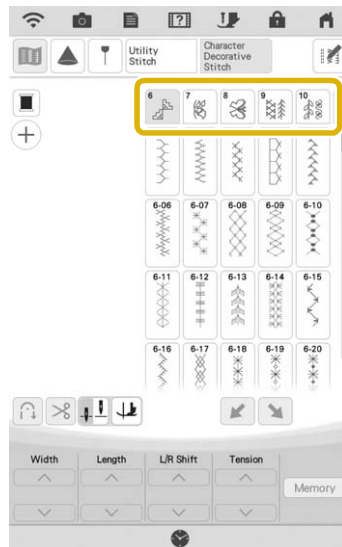
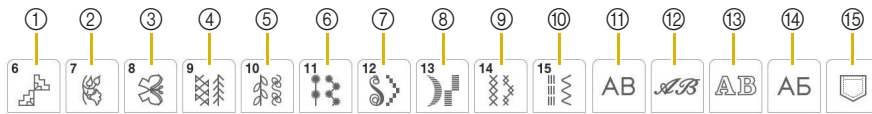

SELECTING STITCH PATTERNS

Press , then  to display the screen below.



- ① Wide and Various
- ② Wide Botanical
- ③ Wide Motifs and Messages
- ④ Narrow and Various
- ⑤ Narrow Botanical
- ⑥ Candlewicking
- ⑦ Large Satin
- ⑧ Satin
- ⑨ Cross Stitches
- ⑩ Combinable Utility
- ⑪ Alphabet characters (gothic font)
- ⑫ Alphabet characters (handwriting font)
- ⑬ Alphabet characters (outline)
- ⑭ Cyrillic font
- ⑮ Pocket

Note

- If the screen is locked () , unlock the screen by pressing  . While the screen is locked, no other key can be operated.

Stitch Selection Screens

There are 14 categories of Character/Decorative stitch patterns.

<p>Wide and Various</p>	<p>Wide Botanical</p>	<p>Wide Motifs and Messages</p>	<p>Narrow and Various</p>
<p>Narrow Botanical</p>	<p>Candlewicking</p>	<p>Large Satin</p>	<p>Satin</p>
<p>Cross Stitches</p>	<p>Combinable Utility</p>	<p>Alphabet characters (gothic font)</p>	<p>Alphabet characters (handwriting font)</p>
<p>Alphabet characters (outline)</p>	<p>Cyrillic font</p>		



Selecting Decorative Stitch Patterns

- 1 Select the category of the stitch pattern you want to sew.
- 2 Press the key of the stitch pattern you want to sew.

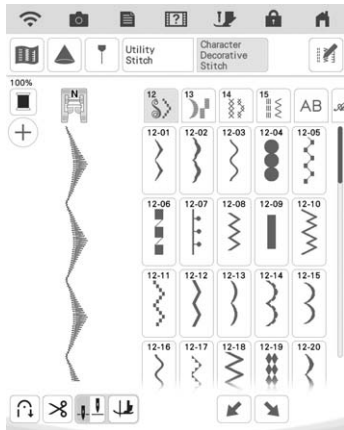

→ The selected stitch pattern is displayed.

Selecting Character Stitch Patterns

Entering characters from the groups shown below, for example “Blue Sky”.

- 1 Press **AB**, **ABC**, **AB** or **AB** to select a font.

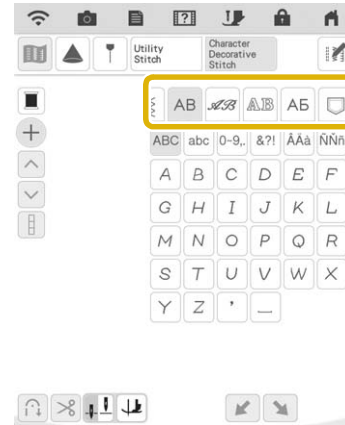

- 2 Press to change the selection screens.



- 3 Press **ABC** and then enter “B”.

- 4 Press **abc** and then enter “lue”.

5 Press **[-]** to enter a space.



6 Press **[ABC]** again and enter "S".

7 Press **[abc]** and then enter "ky".



① Jump stitch

- * Remove the jump stitches after sewing.
- * To continue entering characters in a different font, select the other font, and then repeat the procedure from step 1.

■ Deleting Characters

1 Press **[⌫]**, and then press **[Delete]** to delete the last character.

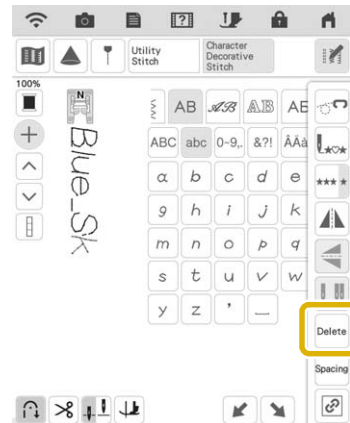

2 Select the correct character.

■ Adding Characters

1 Press **[+]** so that screen displays **[+]**.

2 Press **[^]** or **[v]** to move the cursor in front of the character where you want to add characters.

3 Select the character you want to add.

■ Adjusting the Character Spacing

The space between the characters can be adjusted.

1 Press **[⌫]**, and then press **[Spacing]**.



→ The character spacing window appears.

2 Press **-** **+** to adjust character spacing.

- * Press **+** to increase the character spacing and press **-** to decrease the character spacing.

**Memo**

- The default setting is "0". No number less than "0" can be set.
- Changing character spacing by this method, pertains to all characters. Spacing changes are valid not only while entering characters but also before and after the entering of characters.

SEWING STITCH PATTERNS

Sewing Attractive Finishes

To achieve attractive results when sewing character/decorative stitches, check the table below for the proper fabric/needle/thread combinations.



Note

- Other factors, such as fabric thickness, stabilizer material, etc., also have an effect on the stitch, so you should always sew a few trial stitches before beginning your project.
- When sewing satin stitch patterns, there may be shrinking or bunching of stitches, so be sure to attach a stabilizer material.
- Guide the fabric with your hand to keep the fabric feeding straight and even during sewing.

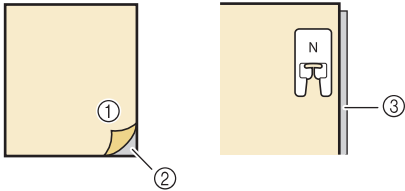
Fabric	When sewing on stretch fabrics, lightweight fabrics, or fabrics with coarse weaves, attach stabilizer on the wrong side of the fabric. If you do not wish to do so, place the fabric on a thin paper such as tracing paper.  ① Fabric ② Stabilizer ③ Thin paper
Thread	#50 - #60
Needle	With lightweight, regular, or stretch fabrics: the Ball point needle (golden colored) With heavyweight fabrics: home sewing machine needle 90/14
Presser foot	Monogramming foot "N". Using another presser foot may give inferior results.

4

Character/Decorative Stitches

Basic Sewing

- 1 Select a stitch pattern.
- 2 Attach monogramming foot "N".
- 3 Place the fabric under the presser foot, pull the upper thread out to the side, and then lower the presser foot.

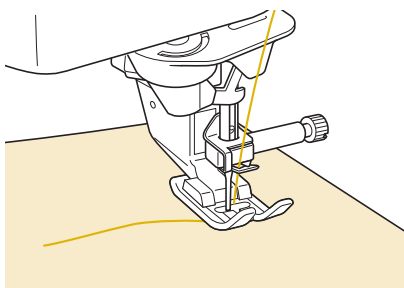

- 4 Press the "Start/Stop" button to start sewing.

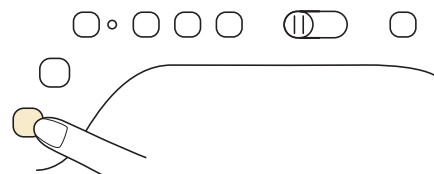

CAUTION

- When sewing 7 mm satin stitch patterns and the stitches are bunched, lengthen the stitch length. If you continue sewing when the stitches are bunched, the needle may bend or break ("Setting the Stitch Length" on page 86).



Memo

- If the fabric is pulled or pushed during sewing, the stitch pattern may not turn out correctly. Also, depending on the stitch pattern, there may be movement to the left and right as well as front and back. Guide the fabric with your hand to keep the fabric feeding straight and even during sewing.

- 5 Press the "Start/Stop" button to stop sewing.
- 6 Keep pressing the "Reverse Stitch" button or the "Reinforcement Stitch" button to sew 4 stitches of reinforcement stitches.

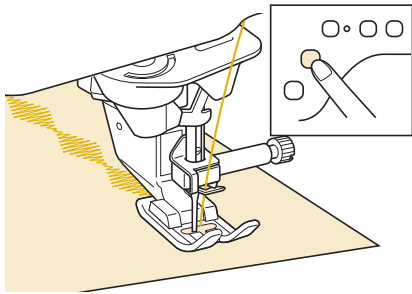

Memo

- When sewing character stitches, the machine automatically sews reinforcement stitches at the beginning and end of each character.

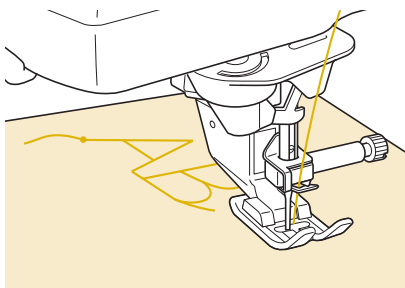

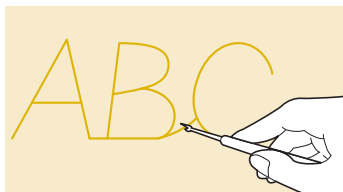

- After sewing is finished, use a seam ripper to trim any excess thread (jump stitches).



Making Adjustments

Your stitch pattern may sometimes turn out poorly, depending on the type or thickness of fabric, the stabilizer material used, sewing speed, etc. If your sewing does not turn out well, sew trial stitches using the same conditions as the real sewing, and adjust the stitch pattern as explained below. If the stitch pattern does not turn out well even after

making adjustments based on the  stitch pattern, make adjustments for each stitch pattern individually.

- 1 Press  and select .

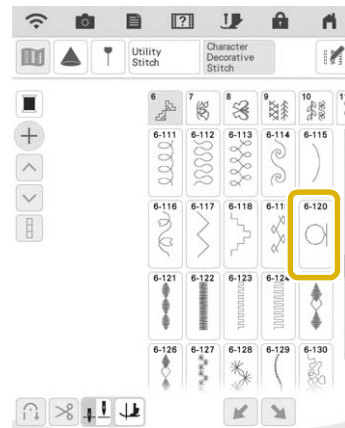

- 2 Attach monogramming foot "N" and sew the stitch pattern.

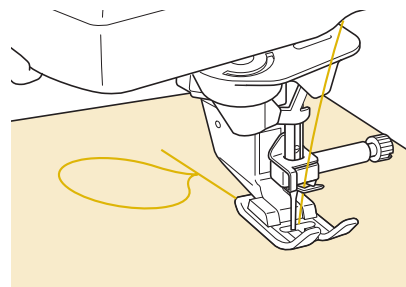

- 3 Compare the finished stitch pattern to the illustration of the correct stitch pattern below.



- 4** Press , and then adjust the stitch pattern with the “Fine Adjust Verti.” or “Fine Adjust Horiz.” displays.

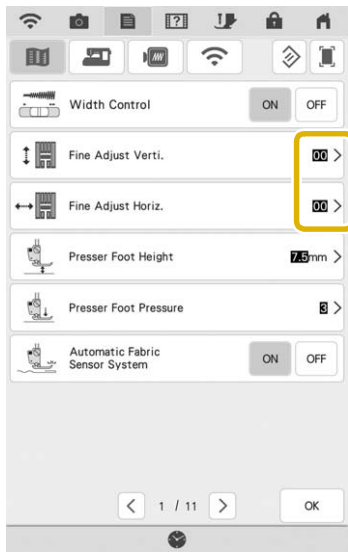

- * If the stitch pattern is bunched:
Touch to increase the number in the “Fine Adjust Verti.” display.
- The displayed value increases each time the button is pressed and the stitch pattern will lengthen.



- * If the stitch pattern has gaps:
Touch to decrease the number in the “Fine Adjust Verti.” display.
- The displayed value decreases each time the button is pressed and the stitch pattern will shorten.



- * If the stitch pattern is skewed to the left:
Touch to increase the number in the “Fine Adjust Horiz.” display.
- The displayed value increases each time the button is pressed and the stitch pattern will slide to the right.



- * If the stitch pattern is skewed to the right:
Touch to decrease the number in the “Fine Adjust Horiz.” display.
- The displayed value decreases each time the button is pressed and the stitch pattern will slide to the left.



- 5** Sew the stitch pattern again.

- * If the stitch pattern still comes out poorly, make adjustments again. Adjust until the stitch pattern comes out correctly.



Memo

- You can sew with the setting screen on the display.

- 6** Press  to return to the original screen.

EDITING STITCH PATTERNS

Key Functions







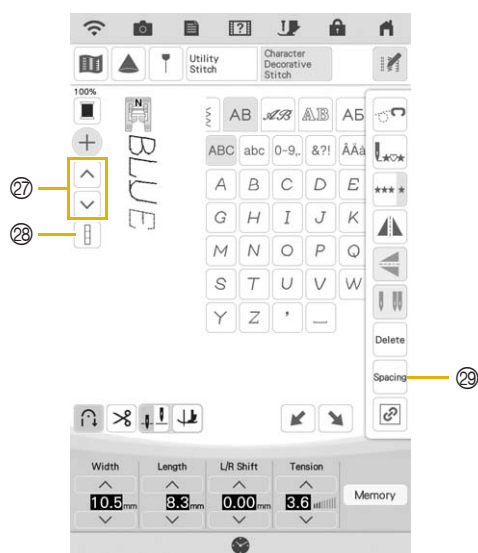
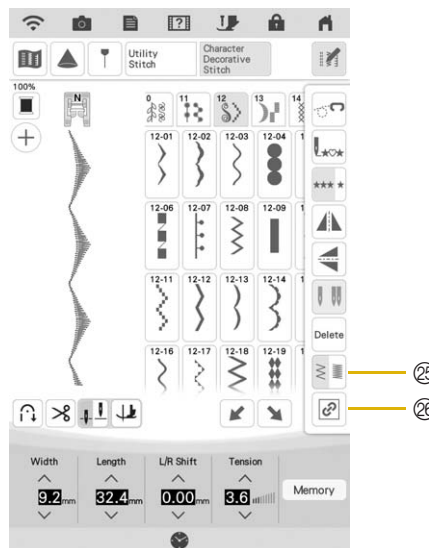
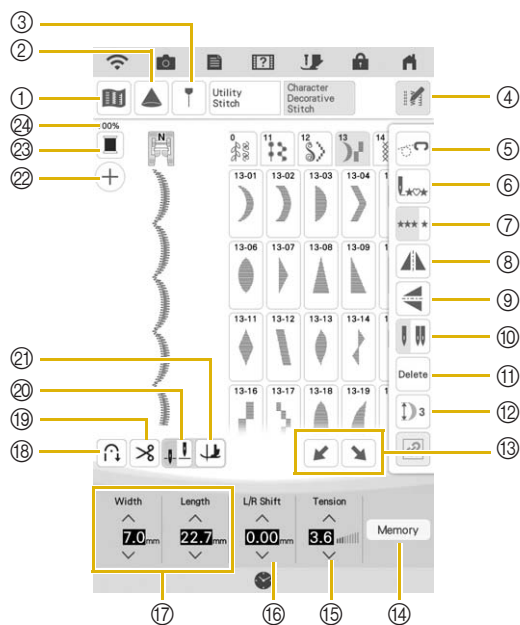

You can create just the finish you want using the editing functions. Make stitch patterns larger or smaller, make mirror images, etc.



- Some editing functions cannot be used with certain stitch patterns. Only the functions for the displayed keys are available when a stitch pattern is selected.



No.	Display	Key Name	Explanation	Page
①		Image key	Press this key to display an enlarged image of the selected stitch pattern.	171
②		Projector key	Press this key to use projector functions.	96
③		Guideline marker key	Press this key to display or set the guideline marker for the sewing line. The guideline marker makes quilt piecing or aligning stitching on the fabric edge easier.	98
④		Stitch pattern editing key	Press this key to display editing function keys on the screen.	103
⑤		Free motion mode key	Press this key to enter free motion sewing mode. The feed dog is lowered and presser foot is raised to a height appropriate for free motion quilting.	126
⑥		Back to beginning key	When sewing is stopped, press this key to return to the beginning of the stitch pattern.	170
⑦		Single/Repeat sewing key	Press this key to choose single stitches or continuous stitches.	169
⑧		Horizontal mirror image key	After selecting the stitch pattern, use this key to create a horizontal mirror image of the stitch pattern.	169
⑨		Vertical mirror image key	After selecting the stitch pattern, use this key to create a vertical mirror image of the stitch pattern.	169
⑩		Needle mode selection key (single/double)	Press this key to select twin needle sewing mode. The sewing mode changes between single needle mode and twin needle mode each time you press the key. If the key display is light gray, the selected stitch pattern cannot be sewn in the twin needle mode.	64
⑪		Delete key	When you make a mistake selecting a stitch pattern, use this key to delete the mistake. When you make a mistake in combining stitch patterns, use this key to delete stitch patterns.	161
⑫		Elongation key	When 7mm satin stitch patterns are selected, press this key to choose from 5 automatic length settings, without changing the stitch zigzag width or stitch length settings.	169
⑬		Step effect key	Press this key to make step stitch patterns.	175
⑭		Memory key	Use this key to save stitch pattern combinations.	179
⑮		Thread tension key	Shows the automatic thread tension setting of the currently selected stitch pattern. You can use and to change the thread tension settings.	87
⑯		“L/R Shift” key	Press to shift the stitch pattern to the right or press to shift the stitch pattern to the left. This feature is not available on all stitch patterns. Only those applicable will be shifted. The machine default setting is highlighted.	86
⑰		Stitch width and stitch length key	Shows the stitch width and stitch pattern length of the selected stitch pattern. The machine default settings are highlighted.	85, 86
⑱		Automatic reinforcement stitch key	Press this key to use the automatic reinforcement stitching (reverse stitching) setting. If you select this setting before sewing, the machine will automatically sew reinforcement stitches at the beginning and end of sewing (depending on the stitch pattern, the machine may sew reverse stitches).	79
⑲		Automatic thread cutting key	Press this key to set the automatic thread cutting function. Set the automatic thread cutting function before sewing to have the machine automatically sew reinforcement stitches at the beginning and end of sewing (depending on the stitch pattern, the machine may sew reverse stitches) and trim the threads after sewing.	88
⑳		Needle position setting key	Press this key to select the needle stop position to be up or down. You can also check the needle mode setting (single or twin). Single needle/down position Single needle/up position Twin needle/down position Twin needle/up position	64, 89
㉑		Pivot key	Press this key to select the pivot function. When the pivot function is selected, stopping the machine lowers the needle and slightly raises the presser foot automatically. In addition, when sewing is restarted, the presser foot is automatically lowered.	89

No.	Display	Key Name	Explanation	Page
22		Add stitch pattern key	Press this key to add a new stitch pattern.	161
23		Thread color change key	Press this key to change the thread color displayed on the screen.	171
24		Stitch pattern display size	Show the approximate size of the stitch pattern selected. 100% : Nearly the same size as the sewn stitch pattern 50% : 1/2 the size of the sewn stitch pattern 25% : 1/4 the size of the sewn stitch pattern * The actual size of the sewn stitch pattern may differ depending on the type of fabric and thread that is used.	105
25		Thread density key	After selecting the stitch pattern, use this key to change the thread density of the stitch pattern.	170
26		Maintain aspect ratio key	Press this key to maintain the aspect ratio when enlarging or reducing the stitch pattern.	169
27		Stitch pattern selection key	Press this key to enter or edit the stitch pattern immediately after the selected stitch pattern.	161
28		Select all on/off key	Press this key to switch between selecting only the last stitch pattern entered or all combined stitch patterns.	169
29		Character spacing key	Press this key to change the spacing of character stitch patterns.	161

Changing the Size

Select a stitch pattern, then press or to change the size of the stitch pattern.

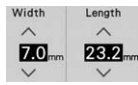

Memo

- When the select all on/off key appears as , the size of all stitch patterns can be changed.
- When the maintain aspect ratio key appears as , the stitch pattern size can be changed while maintaining the aspect ratio.

Stitch Pattern Size

* The size differs depending on the fabric and threads.



Changing the Length (for 7mm Satin Stitch Patterns Only)

When 7mm satin stitch patterns are selected, press , and then press to choose from 5 automatic length settings, without changing the stitch zigzag width or stitch length settings.

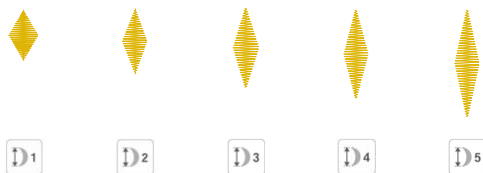

Creating a Vertical Mirror Image

To create a vertical mirror image, select a stitch pattern, press , and then press .



Creating a Horizontal Mirror Image

To create a horizontal mirror image, select a stitch pattern, press , and then press .



Sewing a Stitch Pattern Continuously

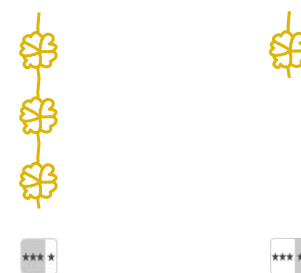

Press , and then press to select continuous sewing or single stitch sewing.



Memo



- To finish a complete motif while sewing the stitch pattern continuously, you can press the key while sewing. The machine will automatically stop when the motif is finished.

Changing Thread Density (for Large Satin Only)

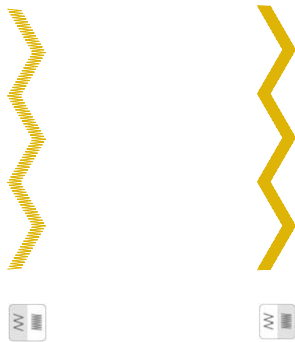
After selecting a satin stitch pattern, press , and then press  to select your preferred thread density.



CAUTION

- If the stitches bunch when thread density is changed to , return the thread density to . If you continue sewing when the stitches are bunched, the needle may bend or break.





Memo

- When the select all on/off key appears as , the thread density of all stitch patterns can be changed.

Returning to the Beginning of the Stitch Pattern

When sewing character/decorative stitches, you can return to the beginning of the stitch pattern after trial sewing or when the stitching is sewn incorrectly.

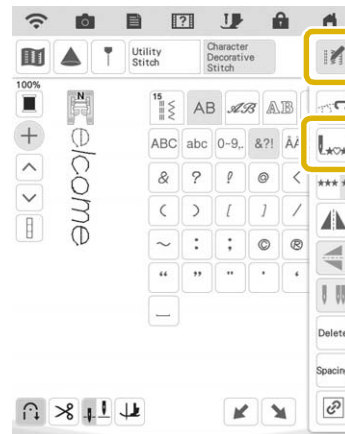

- 1 Press the “Start/Stop” button to stop the machine, press , and then press .



→ Sewing returns to the beginning of the selected stitch pattern (“W”) from the point where sewing was stopped.



Memo



- If this key is pressed while sewing is stopped, stitch patterns can be added at the end of a combined stitch pattern. (In this example, “!” is added.) Press  or  to add the stitch pattern at the desired location.



- 2 Press the “Start/Stop” button to continue sewing.



Checking the Image

You can display an approximate size image of the selected stitch pattern. You can also check and change the colors of the image on the screen.

- 1 Press .
 - An image of the selected stitch pattern is displayed.
- 2 Press  to change the thread color in the image to red, blue, black or yellow.



→ The color changes every time you press the button.

- 3 Press   to display the enlarged image.
- 4 Scroll with your finger to view any part of the image that extends out of the viewable display area.
- 5 Press  to return to the original screen.

COMBINING STITCH PATTERNS

You can combine many varieties of stitch patterns, such as character stitches, cross stitches or satin stitches. You can also combine stitch patterns of different sizes, mirror image stitch patterns, and others.

Before Combining

Single stitch sewing is automatically selected for sewing combined stitch patterns. If you want to sew the stitch pattern continuously, press ******* after finishing the stitch pattern combination.

Combining Various Stitch Patterns

Example:



1 Press .

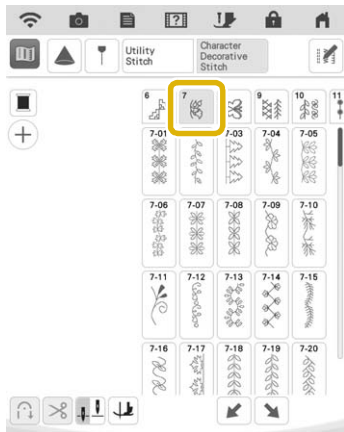

2 Select .

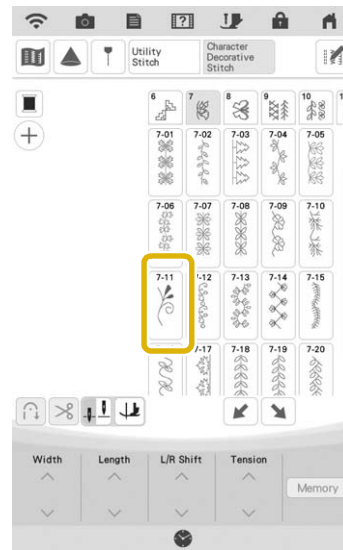

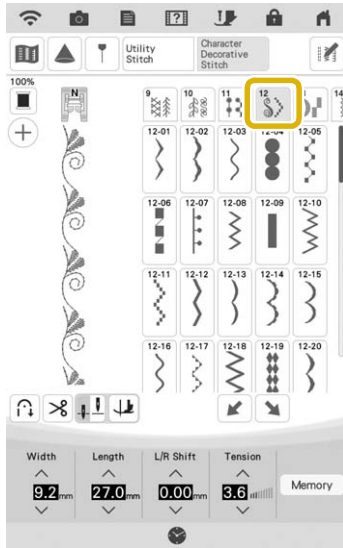

3 Press .

4 Press .

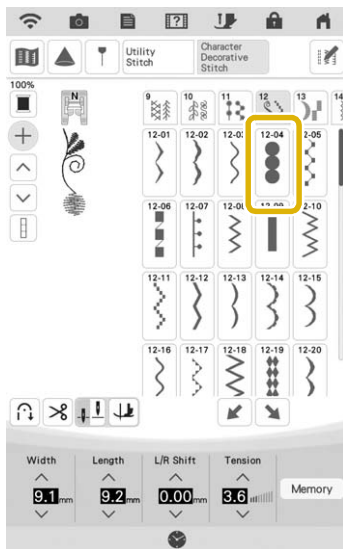

5 Select .



6 Press  to sew the stitch pattern continuously.



Memo

- Stitch patterns are deleted individually starting with the last stitch pattern entered by pressing .

Combining Large and Small Stitch Patterns



Example:



1 Press .

→ The large size stitch will be selected.

2 Press  so that it displays .

3 Press  again, and then press  to change the size.

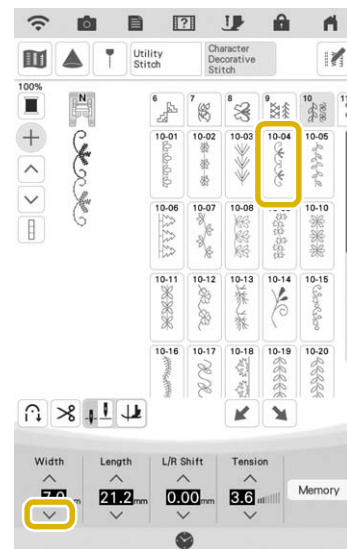



→ The size of the stitch pattern changes.



Memo

- To change the size of the stitch pattern while maintaining the aspect ratio, press the maintain aspect ratio key (.

4 Press , and then press  to sew continuously.



→ The entered stitch pattern is repeated.

Combining Horizontal Mirror Image Stitch Patterns

Example:



1 Press .

2 Press .

3 Press  again, press , and then press .



→ The stitch pattern is flipped along a vertical axis.

4 Press .









→ The entered stitch pattern is repeated.

Combining Stitch Patterns of Different Length

Example:



- 1 Press , then press  once.
→ The length of the image is set to .
- 2 Press .
- 3 Select  again, press , and then press  3 times.

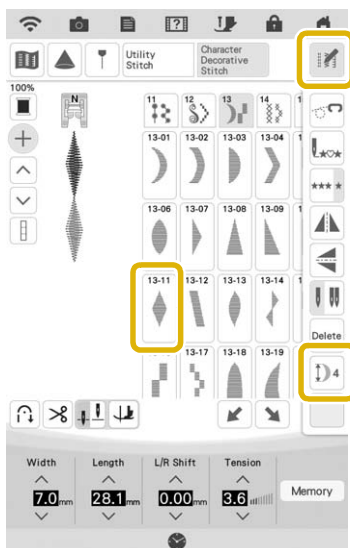

→ The length of the image is set to .

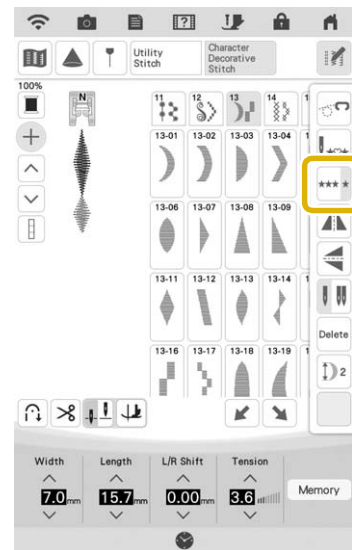

4 Press .



→ The entered stitch pattern is repeated.

Making Step Stitch Patterns

You can use the   keys to create a step effect, also called step stitch patterns.

- * Press  to move the stitch pattern a distance equal to half of the stitch pattern's size to the left.
- * Press  to move the stitch pattern a distance equal to half of the stitch pattern's size to the right.

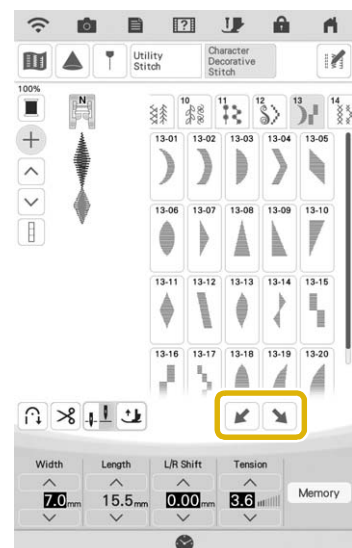

Example:



1 Press  .

2 Press  .

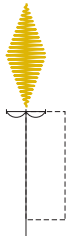

→ The next stitch pattern will move to the right.

3 Press  again.

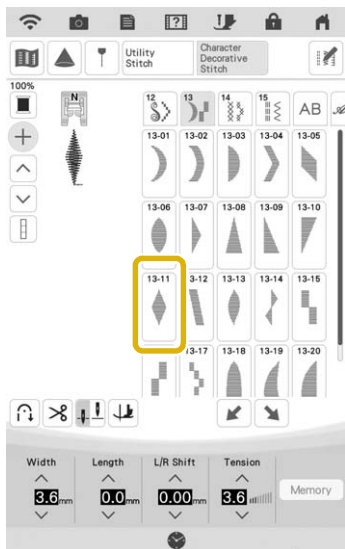

4 Press  .





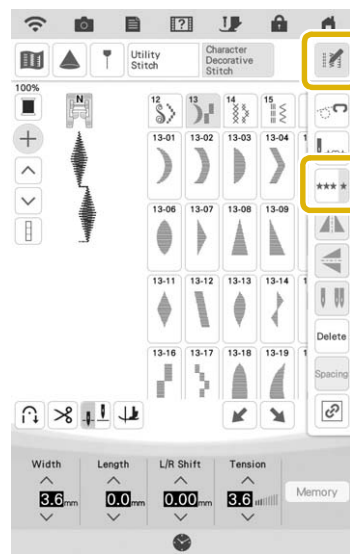

→ The next stitch pattern will move to the left.

5 Press  , and then press  .



→ The entered stitch pattern is repeated.

More Examples

Press  →  →  →  →  .



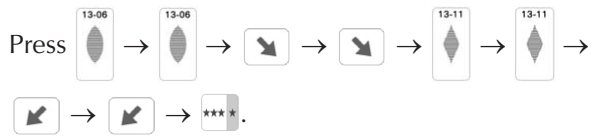
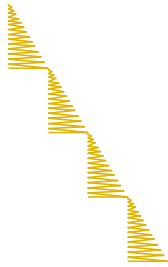
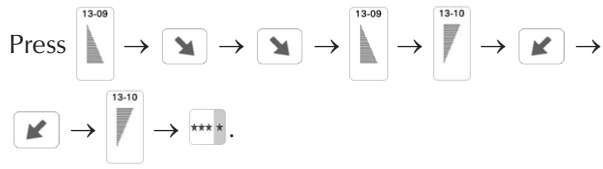

4

USING THE MEMORY FUNCTION

Stitch Data Precautions

Observe the following precautions when using stitch data other than that created and saved in this machine.

■ Types of Stitch Data that can be Used

- In the Character/Decorative Stitch memory, “.pmv”, “.pmx”, “.pmu” and “.pmp” stitch data files can be used with this machine. When the machine is used to save a file with any extension, it is saved as a “.pmp” data file.
- Using data other than that created using this machine or the machine which create “.pmu” data file, may cause the machine to malfunction.

■ Types of USB Devices/Media that can be Used

Stitch data can be saved to or recalled from USB external media. Use external media that meets the following specifications.

- USB Flash drive (USB Flash memory)

Stitch data can be recalled only from;

- USB CD-ROM, CD-R, CD-RW drives

You can also use the following types of USB media with the USB Memory Card Reader/USB card writer module.

- Secure Digital (SD) Card
- CompactFlash
- Memory Stick
- Smart Media
- Multi Media Card (MMC)
- xD-Picture Card



Note

- Some USB media may not be usable with this machine. Please visit our website for more details.
- The access lamp will begin blinking after inserting USB devices/media, and it will take about 5 to 6 seconds to recognize the devices/media. (Time will differ depending on the USB device/media).

- To create file folders, use a computer.

■ Precautions on Using the Computer to Create and Save Data

- If the name of the stitch data file/folder cannot be identified, for example, because the name contains special characters, the file/folder is not displayed. If this occurs, change the name of the file/folder. We recommend using the 26 letters of the alphabet (uppercase and lowercase), the numbers 0 through 9, “-”, and “_”.
- Stitch data in a folder created in USB media can be retrieved.

Saving Stitch Patterns in the Machine's Memory

You can save often used stitch patterns in the machine's memory. A total of about 1 MB of stitch patterns can be saved in the machine's memory.



Note

- Do not turn the main power to OFF while the "Saving..." screen is displayed. You will lose the stitch pattern you are saving.



Memo

- It takes a few seconds to save a stitch pattern.
- Refer to page 180 for information on retrieving a saved stitch pattern.

1 Press **Memory**.



2 Press **Save**.

- Press **Cancel** to return to the original screen without saving.



→ The "Saving..." screen is displayed. When the stitch pattern is saved, the display returns to the original screen automatically.

If the Memory is Full

If the following screen appears while you are trying to save a stitch pattern, the memory is too full to hold the currently selected stitch pattern. To save the stitch pattern in the machine's memory, you have to delete a previously saved stitch pattern.

Press **OK**, and then refer to "Retrieving Stitch Patterns from the Machine's Memory" on page 180.

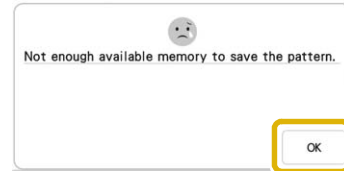

Saving Stitch Patterns to USB Media

When sending stitch patterns from the machine to USB media, plug the USB media into the machine's USB port.



Memo

- USB media is commercially available, but some USB media may not be usable with this machine. Please visit our website for more details.
- Depending on the type of USB media being used, either directly plug the USB device into the machine's USB port or plug the USB media Reader/Writer into the machine's USB port.
- The USB media can be inserted or removed at any time.

1 Press **Memory**.



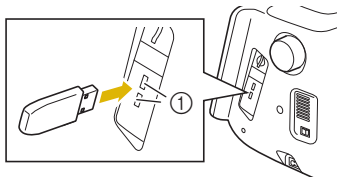

2 Insert the USB media into the USB port on the machine.



① USB port

3 Press .

- * Press  when connecting the USB media to the USB port for mouse.
- * Press  to return to the original screen without saving.



→ The “Saving...” screen is displayed. When the stitch pattern is saved, the display returns to the original screen automatically.



Note

- Do not insert or remove USB media while “Saving...” screen is displayed. You will lose some or all of the stitch pattern you are saving.

Retrieving Stitch Patterns from the Machine’s Memory

1 Press .

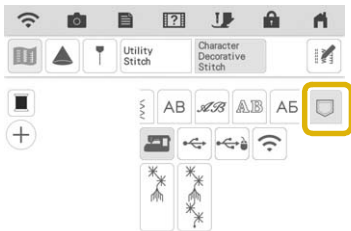

→ The pocket selection screen appears.

2 Choose a stitch pattern to retrieve.

- * If the entire saved stitch pattern is not displayed, press the thumbnail.

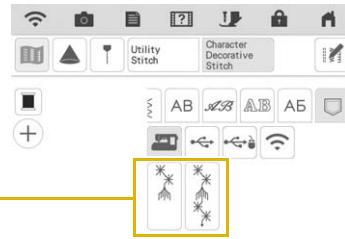

① Saved stitch patterns

→ The selected stitch pattern is retrieved and the sewing screen will be displayed.

Recalling from USB Media

You can recall a specific stitch pattern from either direct USB media or a folder in the USB media. If the stitch pattern is in a folder, check each folder to find the stitch pattern.

- 1 Insert the USB media into the USB port on the machine. (page 179)

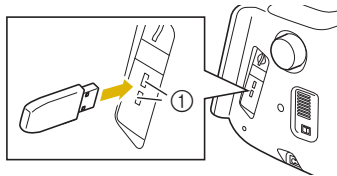

① USB port

- 2 Press .

* Press  when connecting the USB media to the USB port for mouse.

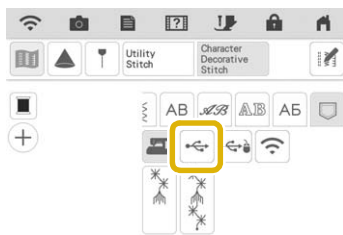

→ Stitch patterns and a folder in a top folder are displayed.

- 3 Press  when there is a subfolder to sort two or more stitch patterns to USB media, the stitch pattern in the subfolder is displayed.

* Press  to return to the original screen without recalling.

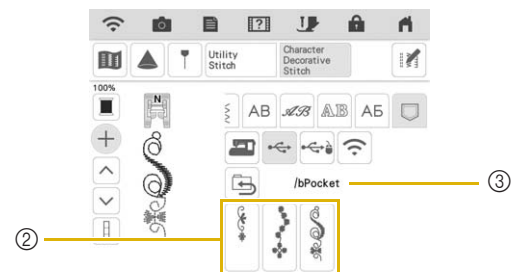
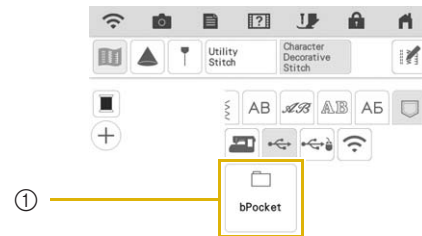

- ① Folder name
- ② Stitch patterns in a folder show only the first stitch pattern of any combined stitch patterns.

- ③ Path

→ The path shows the current folder at the top of the list.

Stitch patterns and a subfolder within a folder are displayed.

- * Press  to return to the previous folder.
- * Use the computer to create folders. Folders cannot be created with the machine.

4 Press the key of the stitch pattern you want to recall.



→ The selected stitch pattern is recalled and the sewing screen will be displayed.

Managing Saved File





You can delete the saved file, or save to machine's memory from USB media.

1 In the retrieving screen from USB, press , and touch the stitch pattern you want to manage.

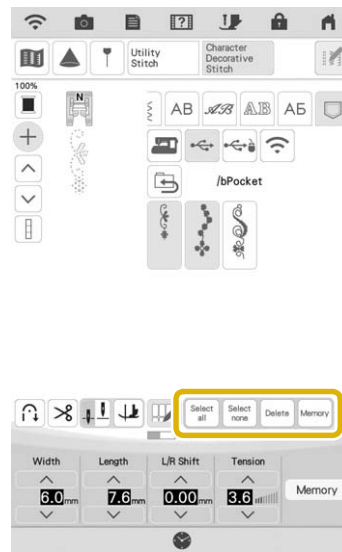

2 Choose the command.



	Press to select all displayed stitch patterns.
	Press to deselect all selected stitch patterns.
	Press to delete the selected stitch patterns.
	Press to save the selected stitch patterns in the machine's memory.



Chapter **5**
Appendix



CARE AND MAINTENANCE

⚠ CAUTION

- Be sure to unplug the machine before cleaning it. Otherwise, electric shock or injury may result.

Restrictions on oiling

In order to prevent damaging this machine, it must not be oiled by the user. This machine was manufactured with the necessary amount of oil applied to ensure correct operation, making periodic oiling unnecessary.

If problems occur, such as difficulty turning the handwheel or an unusual noise, immediately stop using the machine, and contact your authorized Baby Lock retailer.

Precautions on storing the machine

Do not store the machine in any of the locations described below, otherwise damage to the machine may result, for example, rust caused by condensation.

- * Exposed to extremely high temperatures
- * Exposed to extremely low temperatures
- * Exposed to extreme temperature changes
- * Exposed to high humidity or steam
- * Near a flame, heater or air conditioner
- * Outdoors or exposed to direct sunlight
- * Exposed to extremely dusty or oily environments



Note

- In order to extend the life of this machine, periodically turn it on and use it. Storing this machine for an extended period of time without using it may reduce its efficiency.

Cleaning the LCD Screen

If the screen is dirty, gently wipe it with a soft, dry cloth. Do not use organic solvents or detergents.



Note

- Do not wipe the LCD screen with a damp cloth.



Memo

- Occasionally, condensation may form on the LCD screen or it may become fogged up; however, this is not a malfunction. After a while, the cloudiness will disappear.

Cleaning the Machine Casing

If the surface of the machine is dirty, lightly soak a cloth in a neutral detergent, squeeze it out firmly, and then wipe the surface. Then wipe again with a dry cloth.

Cleaning the Race

- 1 Press the "Needle Position" button to raise the needle.
- 2 Turn the main power to OFF.
- 3 Remove the needle and the presser foot holder (page 69, 72).
- 4 Remove the flat bed attachment or the embroidery unit if either is attached.
- 5 Slide the needle plate lever toward you.

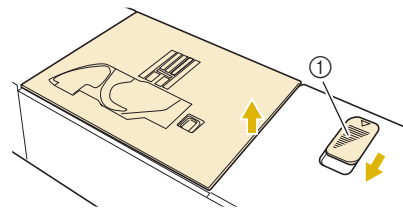

- ① Slide toward you.
→ The needle plate opens.

- 6 Slide out the needle plate with your right hand to remove it.

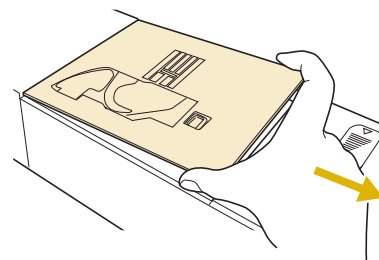

7 Grasp the bobbin case, and then gently lift out.

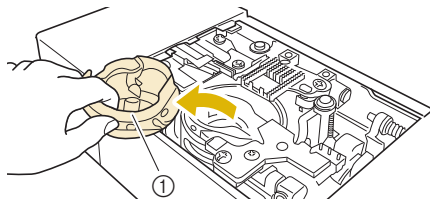

① Bobbin case

8 Use the cleaning brush or a vacuum cleaner to remove any lint and dust from the race and bobbin thread sensor and the surrounding area.

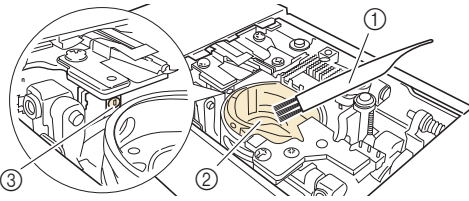

① Cleaning brush
② Race
③ Bobbin thread sensor



Note

- Do not apply oil to the bobbin case.
- If lint or dust collects on the bobbin thread sensor, the sensor may not operate correctly.

9 Insert the bobbin case so that the ▲ mark on the bobbin case aligns with the ● mark on the machine.

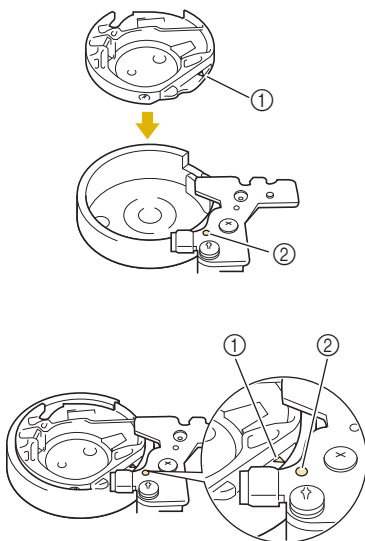

* Align the ▲ and ● marks.

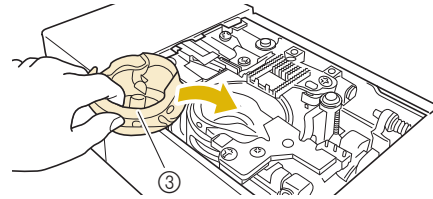

- ① ▲ mark on the bobbin case
- ② ● mark on the machine
- ③ Bobbin case

* Make sure that the indicated points are aligned before installing the bobbin case.

⚠ CAUTION

- Never use a bobbin case that is scratched; otherwise, the upper thread may become tangled, the needle may break, or sewing performance may suffer. For a new bobbin case (part code: XE5342-101 (green marking on the screw), XC8167-551 (no color on the screw)), contact your nearest authorized Baby Lock retailer.
- Make sure that you fit the bobbin case properly, otherwise the needle may break.

10 Insert the tabs on the needle plate into the notches in the machine.

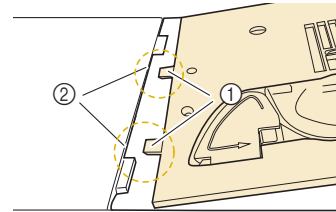

- ① Tabs
- ② Notches

11 Press down on the right side of the needle plate to secure it.

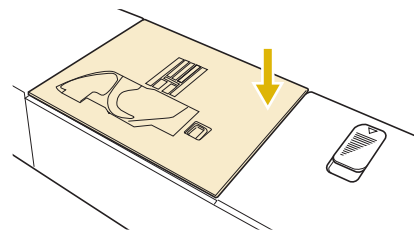

Cleaning the Bobbin Case

Thread wax and dust easily collect around the notch in the tension spring on the bobbin case, resulting in an incorrect thread tension. Therefore, the bobbin case should be cleaned as necessary should tension problems arise.

When cleaning the bobbin case, use card stock or another type of paper of similar thickness and sturdiness in order to prevent pieces of paper tearing off and getting lodged in the bobbin case.

- 1 Follow steps 1 to 7 in “Cleaning the Race” to remove the bobbin case.
- 2 Using a piece of paper of adequate thickness and sturdiness, slide the paper between the tension plate base and the tension spring and also slide the paper behind the notch of the spring to remove any dirt or dust.

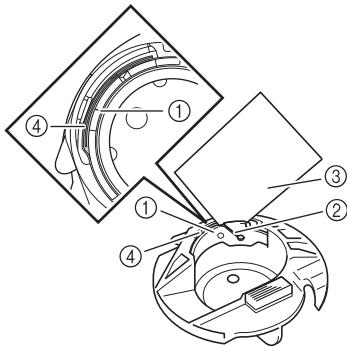

- ① Tension plate base
- ② Notch
- ③ Paper (e.g. business card type)
- ④ Tension spring



Memo

- Do not bend the tension spring. In addition, do not use anything other than recommended paper to clean the bobbin case.

- 3 Use the cleaning brush to remove any lint and dust from inside the bobbin case.
- 4 Replace the bobbin case and needle plate.

Cleaning the Cutter in the Bobbin Case Area

The cutter below the needle plate should be cleaned. If dust or lint accumulate on the cutter, it will be difficult to cut the thread when the “Thread Cutter” button is pressed or the automatic thread cutting function is used. Clean the cutter when the thread is not easily cut.

- 1 Follow steps 1 through 7 in “Cleaning the Race” to remove the needle plate.
- 2 Use the cleaning brush or a vacuum cleaner to remove any lint and dust from the cutter in the bobbin case area.

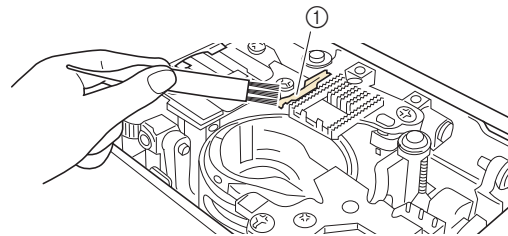

① Cutter

CAUTION

- Do not touch the cutter, otherwise injuries may result.

- 3 Attach the needle plate.

About the Maintenance Message



Once this message appears, it is recommended to take your machine to an authorized Baby Lock retailer for a regular maintenance check. Although this message will disappear and the machine will continue to function once you press , the message will display several more times until the appropriate maintenance is performed.

Please take the time to arrange for the maintenance your machine requires once this message appears. Such steps will help to ensure you receive continued, uninterrupted hours of machine operation for the future.

TROUBLESHOOTING

If the machine stops operating correctly, check the following possible problems before requesting service. You can solve most problems by yourself. Visit us at “ www.babylock.com “.
If the problem persists, contact your authorized Baby Lock retailer.

Frequent Troubleshooting Topics

Detailed causes and remedies for common troubleshooting topics are described below. Be sure to refer to this before contacting your authorized Baby Lock retailer.

■ Upper Thread is Too Tight	page 188
■ Tangled Thread on Wrong Side of Fabric	page 189
■ Incorrect Thread Tension	page 191
■ Fabric is Caught in the Machine and Cannot be Removed	page 192

Upper Thread is Too Tight

■ Symptom

- * The upper thread appears as a single continuous line.
- * The lower thread is visible from the upper side of the fabric. (Refer to the illustration below.)
- * The upper thread has tightened up, and comes out when pulled.
- * The upper thread has tightened up, and wrinkles appear in the fabric.
- * The upper thread tension is tight, and the results do not change even after the thread tension is adjusted.

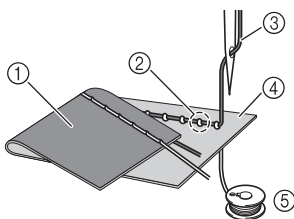

- ① Lower side of fabric
- ② Lower thread visible from upper side of fabric
- ③ Upper thread
- ④ Upper side of fabric
- ⑤ Lower thread

■ Cause

Incorrect lower threading

If the lower thread is incorrectly threaded, instead of the appropriate tension being applied to the lower thread, it is pulled through the fabric when the upper thread is pulled up. For this reason, the thread is visible from the upper side of the fabric.

■ Remedy

Correctly install the lower thread.

- 1 Turn off the machine.
- 2 Remove the bobbin from the bobbin case.
- 3 Place the bobbin in the bobbin case so that the thread unwinds in the correct direction.

- * Hold the bobbin with your right hand with the thread unwinding to the left, and hold the end of the thread with your left hand. Then, with your right hand, place the bobbin in the bobbin case.

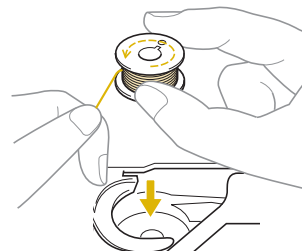

If the bobbin is inserted with the thread unwinding in the wrong direction, sewing will be done with an incorrect thread tension.

4 While holding the bobbin in place with your finger, pass the thread through the slit in the needle plate.

- * Hold down the bobbin with your right hand, and then pull the end of the thread around the tab with your left hand.

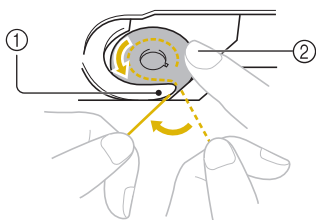

- ① Tab
- ② Hold down the bobbin with your right hand.

Pull the thread to pass it through the slit in the needle plate, then cut it with the cutter.

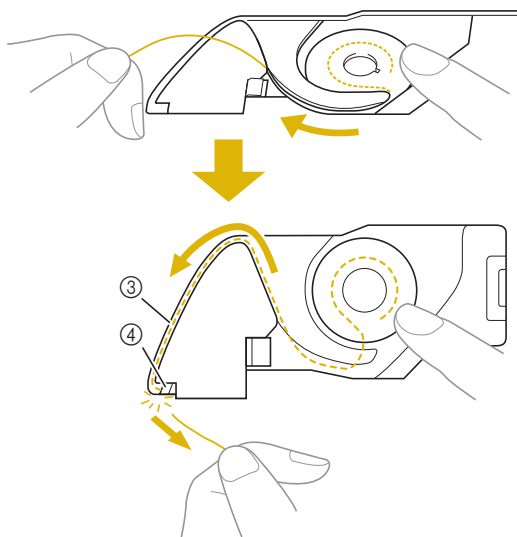

- ③ Slit
- ④ Cutter

Sewing with the correct thread tension is possible after the bobbin has been correctly installed in the bobbin case.

Tangled Thread on Wrong Side of Fabric

■ Symptom

- * The thread becomes tangled on the lower side of the fabric.

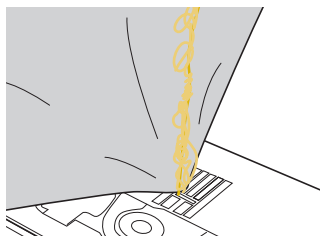

- * After starting sewing, a rattling noise is made and sewing cannot continue.
- * Looking under the fabric, there is tangled thread in the bobbin case.

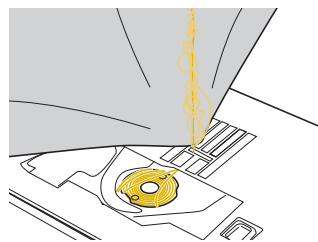

■ Cause

Incorrect upper threading

If the upper thread is incorrectly threaded, the upper thread passed through the fabric cannot be firmly pulled up and the upper thread becomes tangled in the bobbin case, causing a rattling noise.

■ Remedy

Remove the tangled thread, and then correct the upper threading.

1 Remove the tangled thread. If it cannot be removed, cut the thread with scissors.

- * Refer to "Cleaning the Race" in "CARE AND MAINTENANCE" on page 184.

2 Remove the upper thread from the machine.

3 Refer to the following steps to correct the upper threading.

- * If the bobbin was removed from the bobbin case, refer to "Setting the Bobbin" on page 58 and "Remedy" in the section "Upper Thread is Too Tight" on page 188 to correctly install the bobbin.

- 4** Raise the presser foot using the presser foot lever.

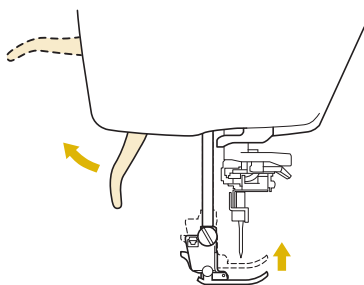

* If the presser foot is not raised, the machine cannot be threaded correctly.

- 5** Raise the needle by turning the handwheel toward you (counterclockwise) so that the mark on the wheel points up, or press “Needle Position” button once or twice to raise the needle.

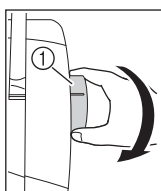

or

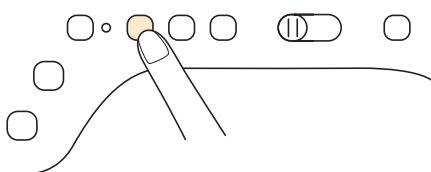

① Mark

- 6** While holding the thread with both hands, pull the thread up from under the thread guide plate.

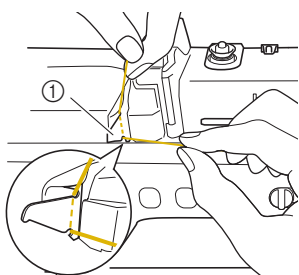

① Thread guide plate

- 7** While holding the thread in your right hand, pass the thread through the thread guide in the direction indicated.

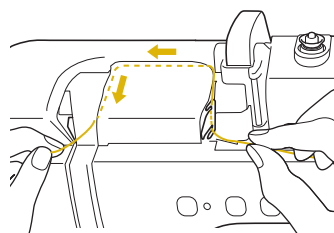

- 8** Guide the thread down, up, then down through the groove, as shown in the illustration.

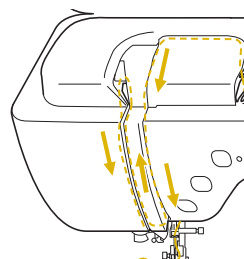

Memo

- Look in the upper groove area to check if the thread catches on the thread take-up lever visible inside the upper groove area.

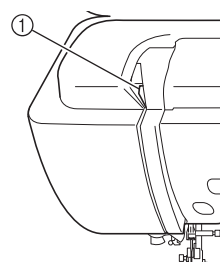

① Look in the upper groove area

- 9** Pass the thread through the needle bar thread guide (marked “6”) by holding the thread with both hands and guiding it as shown in the illustration.

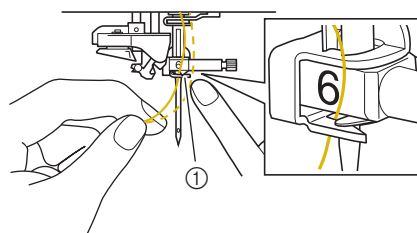

① Needle bar thread guide

- 10** Thread the needle according to steps **10** and **15** in “UPPER THREADING” on page 61.

Incorrect Thread Tension

■ Symptoms

- Symptom 1: The lower thread is visible from the upper side of the fabric.
- Symptom 2: The upper thread appears as a straight line on the upper side of the fabric.
- Symptom 3: The upper thread is visible from the lower side of the fabric.
- Symptom 4: The lower thread appears as a straight line on the lower side of the fabric.
- Symptom 5: The stitching on the lower side of the fabric is loose or has slack.

□ Symptom 1

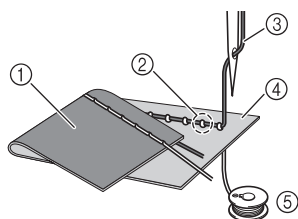

□ Symptom 3

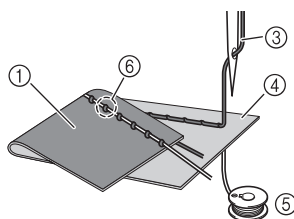

- ① Lower side of fabric
- ② Lower thread visible on upper side of fabric
- ③ Upper thread
- ④ Upper side of fabric
- ⑤ Lower thread
- ⑥ Upper thread visible from lower side of fabric

■ Cause/remedy

□ Cause 1

The machine is not correctly threaded.

<With symptoms 1 and 2 described above>

The lower threading is incorrect.

Adjust the upper thread tension and then refer to “Upper Thread is Too Tight” on page 87.

<With symptoms 3 through 5 described above>

The upper threading is incorrect.

Adjust the upper thread tension and then refer to “Tangled Thread on Wrong Side of Fabric” on page 189 to correct the upper threading.

□ Cause 2

A needle and thread appropriate for the fabric are not being used.

The machine needle that should be used depends on the type of fabric sewn and the thread thickness.

If a needle and thread appropriate for the fabric are not being used, the thread tension will not be adjusted correctly, causing wrinkles in the fabric or skipped stitches.

- * Refer to “Fabric/Thread/Needle Combinations” on page 71 to check that a needle and thread appropriate for the fabric are being used.

□ Cause 3

An appropriate upper tension is not selected.

Adjust the upper thread tension to select an appropriate thread tension.

The appropriate thread tension differs according to the type of fabric and thread being used.

- * Adjust the thread tension while test sewing on a piece of scrap fabric that is the same as that used in your project.



Note

- If the upper threading and lower threading are incorrect, the thread tension cannot be adjusted correctly, even by adjusting the upper thread tension. Check the upper threading and lower threading first, and then adjust the thread tension.

- * When the lower thread is visible on the upper side of the fabric. Set the upper thread tension to a lower number. (Loosen the thread tension.)
- * When the upper thread is visible on the lower side of the fabric. Set the upper thread tension to a higher number. (Tighten the thread tension.)



Fabric is Caught in the Machine and Cannot be Removed

If the fabric is caught in the machine and cannot be removed, the thread may have become tangled under the needle plate. Follow the procedure described below to remove the fabric from the machine. If the operation could not be completed according to the procedure, instead of attempting to complete it forcefully, contact your authorized Baby Lock retailer.

■ Removing the fabric from the machine

1 Immediately stop the machine.

2 Turn off the machine.

3 Remove the needle.

If the needle is lowered into the fabric, turn the handwheel away from you (clockwise) to raise the needle out of the fabric, and then remove the needle.

* Refer to "CHANGING THE NEEDLE" on page 69.

4 Remove the presser foot and presser foot holder.

* Refer to "CHANGING THE PRESSER FOOT" on page 72.

5 Lift up the fabric and cut the threads below it.

If the fabric can be removed, remove it. Continue with the following steps to clean the race.

6 Slide the needle plate lever toward you.

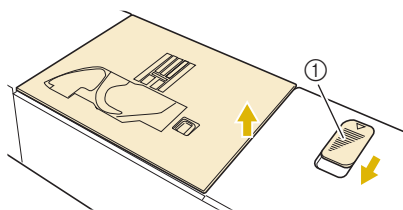

① Slide toward you.
→ The needle plate opens.

7 Slide out the needle plate with your right hand to remove it.

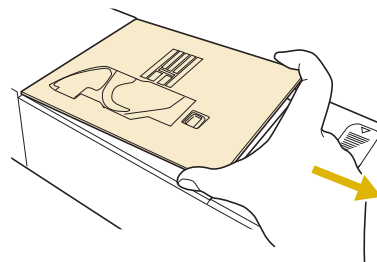

8 Grasp the bobbin case, and then gently lift out.

If threads remain in the bobbin case, remove them.

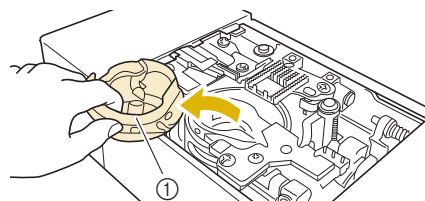

① Bobbin case

9 Use the cleaning brush or a vacuum cleaner to remove any dust or loose threads from the race and its surrounding area.

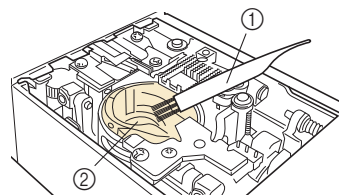

① Cleaning brush
② Race

10 Insert the bobbin case so that the ▲ mark on the bobbin case aligns with the ● mark on the machine.

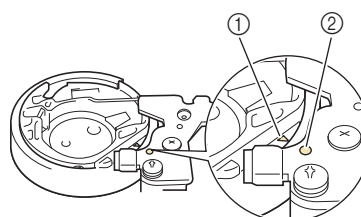
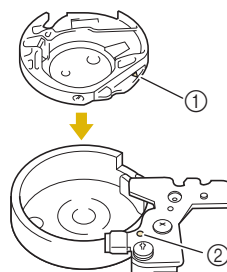

- * Align the ▲ and ● marks.

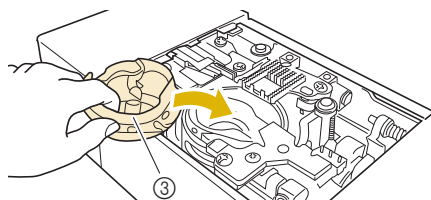

- ① ▲ mark
② ● mark
③ Bobbin case

- * Make sure that the indicated points are aligned before installing the bobbin case.

⚠ CAUTION

- Never use a bobbin case that is scratched; otherwise, the upper thread may become tangled, the needle may break, or sewing performance may suffer. For a new bobbin case (part code: XE5342-101 (green marking on the screw), XC8167-551 (no color on the screw)), contact your nearest authorized Baby Lock retailer.
- Make sure that you fit the bobbin case properly, otherwise the needle may break.

11 Insert the tabs on the needle plate into the notches in the machine.

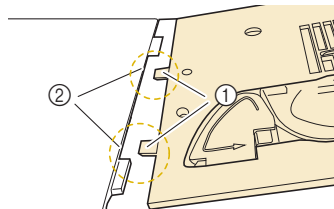

- ① Tabs
② Notches

12 Press down on the right side of the needle plate to secure it.

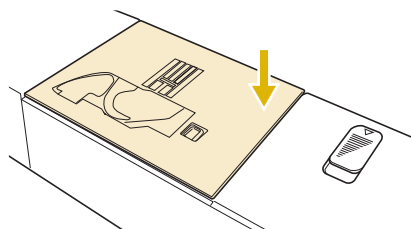

13 Check the condition of the needle, and then install it.

If the needle is in a poor condition, for example, if it is bent, be sure to install a new needle.

- * Refer to "CHANGING THE NEEDLE" on page 69.

⚠ CAUTION

- Never use bent needles. Bent needles can easily break, possibly resulting in injuries.



Note

- After completing this procedure, continue with the following procedure in "Checking machine operations" to check that the machine is operating correctly.



Memo

- Since the needle may have been damaged when the fabric was caught in the machine, we recommend replacing it with a new one.

■ Checking machine operations

If the needle plate has been removed, check machine operations to confirm that installation has been completed correctly.

1 Turn on the machine.

2 Select 1-03.



Note

- Do not yet install the presser foot and thread.

3 Slowly turn the handwheel toward you (counterclockwise), and look from all sides to check that the needle falls at the center of the hole in the needle plate.

If the needle contacts the needle plate, remove the needle plate, and then install it again.

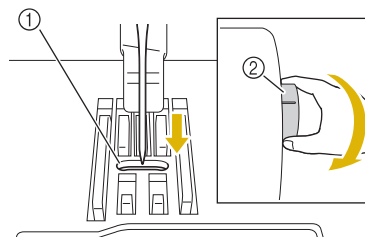

- ① Hole in the needle plate
② Handwheel

4 Select zigzag stitch . At this time, increase the stitch length and width to their maximum settings.

5 Slowly turn the handwheel toward you (counterclockwise) and check that the needle bar and feed dogs operate correctly.

If the needle or feed dogs contact the needle plate, the machine may be malfunctioning; therefore, contact your authorized Baby Lock retailer.

6 Turn off the machine, and then install the bobbin and presser foot.

* Refer to "Setting the Bobbin" on page 58 and "CHANGING THE PRESSER FOOT" on page 72.

7 Correctly thread the machine.

* For details on the machine, refer to "UPPER THREADING" on page 61.



Note

- The thread may have become tangled as a result of incorrect upper threading. Make sure that the machine is correctly threaded.





8 Perform trial sewing with normal fabric.







Note

- Remember when sewing thin fabrics, select a center stitch that is shorter in length and use the straight stitch needle plate for straight sewing stitches. A lightweight paper stabilizer can also be placed on the underside of the fabric.

List of Symptoms

If you have a minor problem with your machine, check the following solutions. If the solutions suggested do not correct the problem, contact your authorized Baby Lock retailer. Press  →  →  for advice about minor sewing problems during sewing. Press  at any time to return to the original screen.

■ Getting ready

Problem	Cause	Solution	Page
Cannot thread the needle.	Needle is not in the correct position.	Press the “Needle Position” button to raise the needle.	15
	Needle is installed incorrectly.	Reinstall the needle correctly.	69
	Needle is turned, bent or the point is dull.	Replace the needle.	69
	Upper threading is incorrect.	Check the steps for threading the machine and rethread the machine.	61
	The needle threader hook is bent and does not pass through the eye of the needle.	Contact your authorized Baby Lock retailer.	—
	The needle threader lever cannot be moved or returned to its original position.	Contact your authorized Baby Lock retailer.	—
	A size 65/9 needle is being used.	The needle is incompatible with the needle threader. Manually pass the thread through the eye of the needle.	64
Cannot lower the presser foot with the presser foot lever.	Presser foot was raised using the “Presser Foot Lifter” button.	Press the “Presser Foot Lifter” button to lower the presser foot.	15
Bobbin thread does not wind neatly on the bobbin.	The thread is not passed through the bobbin winding thread guide correctly.	Correctly pass the thread through the bobbin winding thread guide.	65
	Bobbin spins slowly.	Press  in the bobbin winding window to increase the bobbin winding speed.	55
	The thread that was pulled out was not wound onto the bobbin correctly.	Wind the thread that was pulled off around the bobbin 5 or 6 times clockwise.	53
	The empty bobbin was not set on the pin properly.	Set the empty bobbin on the pin and slowly turn the bobbin until you hear it click in place.	52
While winding the bobbin, the bobbin thread was wound below the bobbin winder seat.	You have not wound the bobbin thread properly when you are initially winding thread on the bobbin as well as being sure that the bobbin thread is set in the guides.	After removing the thread wound below the bobbin winder seat, wind the bobbin correctly. Follow the drawn images on the top of the machine for guidance when threading the machine for bobbin winding.	52
The bobbin thread cannot be pulled up.	Needle is turned, bent or the point is dull.	Replace the needle.	69
	Bobbin is set incorrectly.	Reset the bobbin thread correctly.	58
Machine does not operate	All keys and buttons have been locked by  .	Press to unlock all keys and  buttons.	66, 72
Nothing appears in the LCD.	Main power switch is not turned on.	Turn the main power to ON.	25
	The plug of the power cord is not inserted into an electrical outlet.	Insert the plug of the power cord into an electrical outlet.	26
The LCD screen does not look very clear.	The brightness of the screen is not adjusted.	Adjust the “Screen Display Brightness” in the settings screen.	29
Nothing happens, even if the LCD display is pressed	The screen has been locked.	Press either of the following keys to unlock the screen.  	—
The LCD screen is fogged up.	Condensation has formed on the LCD screen.	After a while, the cloudiness will disappear.	—
The dual purpose stylus cannot be operated.	The dual purpose stylus is dirty.	Clean the light-emitting part of the dual purpose stylus.	—
	The battery is dead.	Replace the battery with a new one.	94

■ While sewing

Problem	Cause	Solution	Page
Machine does not operate.	“Start/Stop” button was not pressed.	Press the “Start/Stop” button.	15
	There is no stitch pattern selected.	Select a stitch pattern.	105, 158
	Presser foot is not lowered.	Lower the presser foot.	15
	“Start/Stop” button was pressed with the foot controller attached.	Remove the foot controller, or use the foot controller to operate the machine.	78
	The “Start/Stop” button was pressed while the machine is set for the sewing speed controller to control the zigzag stitch width.	Use the foot controller instead of the “Start/Stop” button to operate the machine, or set the “Width Control” to “OFF” in the settings screen.	28, 78
Needle breaks.	Needle is installed incorrectly.	Reinstall the needle correctly.	69
	Needle clamp screw is not tightened.	Tighten the needle clamp screw.	70
	Needle is turned or bent.	Replace the needle.	69
	Using improper needle or thread for the selected fabric.	Check the “Fabric/Thread/Needle Combinations” chart.	71
	Wrong presser foot was used.	Use the recommended presser foot.	206
	Upper thread tension is too tight.	Adjust the thread tension.	87
	Fabric is pulled during sewing.	Do not pull the fabric during sewing.	—
	Spool cap is set incorrectly.	Check the method for attaching the spool cap, then reattach the spool cap.	61
	There are scratches around the opening in the needle plate.	Replace the needle plate, or consult your authorized Baby Lock retailer.	184
	There are scratches around the opening in the presser foot.	Replace the presser foot, or consult your authorized Baby Lock retailer.	72
	There are scratches on the bobbin case.	Replace the bobbin case, or consult your authorized Baby Lock retailer.	184
	Needle is defective.	Replace the needle.	69
	A bobbin designed specifically for this machine is not used.	Incorrect bobbins will not work properly. Only use a bobbin designed specifically for this machine.	58
	Upper threading is incorrect.	Check the steps for threading the machine and rethread the machine.	61
	Bobbin is set incorrectly.	Reset the bobbin thread correctly.	58
	Presser foot is attached incorrectly.	Attach the presser foot correctly.	72
	Screw of the presser foot holder is loose.	Securely tighten the screw of the presser foot.	73
	Fabric is too thick.	Use fabric that the needle can pierce when the handwheel is turned.	82
	Fabric is fed forcefully when sewing thick fabric or thick seams.	Allow the fabric to be fed without being forcefully pushed.	71, 82
	Stitch length is too short.	Adjust the stitch length.	86
Bobbin thread is incorrectly wound.	Use a correctly wound bobbin.	52	

Problem	Cause	Solution	Page
Upper thread breaks.	Machine is not threaded correctly (used the wrong spool cap, spool cap is loose, the thread did not catch the needle bar threader, etc.)	Rethread the machine correctly.	61
	Knotted or tangled thread is being used.	Remove any knots or tangles.	—
	The selected needle is not appropriate for the thread being used.	Select a needle that is appropriate for the type of thread being used.	71
	Upper thread tension is too tight.	Adjust the thread tension.	87
	Thread is twisted.	Use scissors, etc., to cut the twisted thread and remove it from the race, etc.	—
	Needle is turned, bent or the point is dull.	Replace the needle.	69
	Needle is installed incorrectly.	Reinstall the needle correctly.	69
	There are scratches around the opening of the needle plate.	Replace the needle plate, or consult your authorized Baby Lock retailer.	184
	There are scratches around the opening in the presser foot.	Replace the presser foot, or consult your authorized Baby Lock retailer.	72
	There are scratches on the bobbin case.	Replace the bobbin case, or consult your authorized Baby Lock retailer.	184
	Using improper needle or thread for the selected fabric.	Check the “Fabric/Thread/Needle Combinations” chart.	71
	While sewing, the thread became knotted or tangled.	Rethread upper and lower thread.	58, 61
A bobbin designed specifically for this machine is not used.	Incorrect bobbins will not work properly. Only use a bobbin designed specifically for this machine.	58	
The thread is tangled on the wrong side of the fabric.	Upper threading is incorrect.	Check the steps for threading the machine and rethread the machine. Be sure that the presser foot is in the raised position when threading the machine so that the upper thread sets properly in the upper tension.	61
	Using improper needle or thread for the selected fabric.	Check the “Fabric/Thread/Needle Combinations” chart.	71
The upper thread is too tight.	The bobbin thread is incorrectly installed.	Correctly install the bobbin thread.	58
Bobbin thread breaks.	Bobbin is set incorrectly.	Reset the bobbin thread correctly.	58
	Bobbin thread is incorrectly wound.	Use a correctly wound bobbin.	52
	There are scratches on the bobbin or it doesn't rotate properly.	Replace the bobbin.	58
	Thread is twisted.	Use scissors, etc. to cut the twisted thread and remove it from the race, etc.	—
	A bobbin designed specifically for this machine is not used.	Incorrect bobbins will not work properly. Only use a bobbin designed specifically for this machine.	58
Fabric puckers.	There is a mistake in the upper or bobbin threading.	Check the steps for threading the machine and rethread it correctly.	58, 61
	Spool cap is set incorrectly.	Check the method for attaching the spool cap, then reattach the spool cap.	61
	Using improper needle or thread for the selected fabric.	Check the “Fabric/Thread/Needle Combinations” chart.	71
	Needle is turned, bent or the point is dull.	Replace the needle.	69
	Stitches are too long when sewing thin fabrics.	Shorten the stitch length.	86
	Thread tension is set incorrectly.	Adjust the thread tension.	87
	Wrong presser foot.	Use the correct presser foot.	206
The stitch is not sewn correctly.	The presser foot that is used is not appropriate for the type of stitch that you wish to sew.	Attach the presser foot that is appropriate for the type of stitch that you wish to sew.	206
	The thread tension is incorrect.	Adjust the tension of the upper thread.	87
	The thread is tangled, for example, in the bobbin case.	Remove the tangle thread. If the thread is tangled in the bobbin case, clean the race.	184
Skipped stitches	Machine is threaded incorrectly.	Check the steps for threading the machine and rethread it correctly.	61
	Using improper needle or thread for the selected fabric.	Check the “Fabric/Thread/Needle Combinations” chart.	71

Problem	Cause	Solution	Page
Skipped stitches	Needle is turned, bent or the point is dull.	Replace the needle.	69
	Needle is installed incorrectly.	Reinstall the needle correctly.	69
	Needle is defective.	Replace the needle.	69
	Dust or lint has collected under the needle plate.	Remove the dust or lint with the brush.	184
	Thin or stretch fabrics are being sewn.	Sew with one sheet of thin paper under the fabric.	84
No stitching	Needle is turned, bent or the point is dull.	Replace the needle.	69
	Bobbin is set incorrectly.	Reset the bobbin thread correctly.	58
	Upper threading is incorrect.	Check the steps for threading the machine and rethread the machine.	61
High-pitched sound while sewing	Dust or lint is caught in the feed dogs.	Remove the dust or lint.	184
	Pieces of thread are caught in the race.	Clean the race.	184
	Upper threading is incorrect.	Check the steps for threading the machine and rethread the machine.	61
	A bobbin designed specifically for this machine is not used.	Incorrect bobbins will not work properly. Only use a bobbin designed specifically for this machine.	58
	There are needle holes or friction scratches in the bobbin case.	Replace the bobbin case, or consult your authorized Baby Lock retailer.	184
Fabric does not feed through the machine.	Feed dogs are set in the down position.	Press  , and then turn the handwheel to raise the feed dogs.	126
	Stitches are too close together.	Lengthen the stitch length setting.	86
	Wrong presser foot was used.	Use the correct presser foot.	206
	Needle is turned, bent or the point is dull.	Replace the needle.	69
	Thread is entangled.	Cut the entangled thread and remove it from the race.	—
	Zigzag foot “J” is slanted on a thick seam at the beginning of stitching.	Use the presser foot locking pin (black button on the left side) on zigzag foot “J” to keep the presser foot level while sewing.	83
The fabric feeds in the opposite direction.	The feed mechanism is damaged.	Contact your authorized Baby Lock retailer.	—
The needle contacts the needle plate.	The needle clamp screw is loose.	Firmly tighten the needle clamp screw. If the needle is bent or blunt, replace it with a new one.	70
	Needle is turned, bent or the point is dull.	Replace the needle.	69
Fabric being sewn with the machine cannot be removed.	Thread is tangled below the needle plate.	Lift up the fabric and cut the threads below it, and clean the race.	189
A broken needle has fallen into the machine.	—	Turn off the machine, and then remove the needle plate. If the needle that fell into the machine can be seen, use tweezers to remove it. After removing the needle, return the needle plate to its original position. Before turning on the machine, slowly turn the handwheel toward you to check that it turns smoothly. If the handwheel does not turn smoothly or the needle that fell into the machine cannot be removed, consult your authorized Baby Lock retailer.	—
The handwheel feels sluggish when it is turned.	Thread is tangled in the bobbin case.	Remove the tangled thread from the bobbin case. Re-install the bobbin case so it is correctly positioned.	189
The built-in camera cannot detect the buttonhole foot.	The buttonhole foot is dirty.	Clean the area of the buttonhole foot to be detected.	141
	Mark “A+” or 3 dots on the presser foot is shaded.	Keep these area clean.	141

■ After sewing

Problem	Cause	Solution	Page
Thread tension is incorrect.	Upper threading is incorrect.	Check the steps for threading the machine and rethread the machine.	61
	Bobbin is set incorrectly.	Reset the bobbin. (If needle plate was removed, reinstall needle plate and tighten screws prior to installing bobbin case.)	58
	Using improper needle or thread for the selected fabric.	Check the "Fabric/Thread/Needle Combinations" chart.	71
	Presser foot holder is not attached correctly.	Reattach the presser foot holder correctly.	—
	Thread tension is set incorrectly.	Adjust the thread tension.	87
	Bobbin thread is incorrectly wound.	Use a correctly wound bobbin.	52
	Needle is turned, bent or the point is dull.	Replace the needle.	69
	A bobbin designed specifically for this machine is not used.	Incorrect bobbins will not work properly. Only use a bobbin designed specifically for this machine.	58
Character or decorative stitch patterns are misaligned.	Stitch pattern adjustment settings were set incorrectly.	Revise the stitch pattern adjustment settings.	164
Stitch pattern does not turn out.	Wrong presser foot was used.	Attach the correct presser foot.	206
	Did not use a stabilizer material on thin fabrics or stretch fabrics.	Attach a stabilizer material.	163
	Thread tension is set incorrectly.	Adjust the thread tension.	87
	Fabric was pulled, pushed or fed at an angle while it was being sewn.	Sew while guiding the fabric with your hands so that the fabric is fed in a straight line.	77
	The thread is tangled, for example, in the bobbin case.	Remove the tangle thread. If the thread is tangled in the bobbin case, clean the race.	184

CAUTION

- This machine is equipped with a thread detection device. If the "Start/Stop" button is pushed before the upper threading is done, the machine will not operate properly.
- If the power is disconnected during sewing:
Turn the main power to OFF and unplug the machine.
If you restart the machine, follow the Instruction and Reference Guide for operating the machine correctly.

ERROR MESSAGES

If the machine is not properly set and the “Start/Stop” button or the “Reverse/Reinforcement Stitch” button is pressed, or if the operation procedure is incorrect, the machine does not start. An alarm sounds and an error message is displayed on the LCD. If an error message displays, follow the instructions in the message.

Below is an explanation of error messages. Refer to these when necessary (if you press or do the operation correctly while the error message is displayed, the message disappears).

CAUTION

- **Be sure to rethread the machine. If you press the “Start/Stop” button without rethreading the machine, the thread tension may be wrong or the needle may break and cause injury.**



This message is displayed when the motor locks due to tangled thread or for other reasons related to thread delivery.

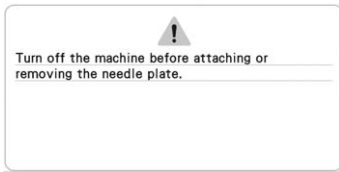

This message is displayed when you try to sew with a stitch other than a middle needle position stitch while the single-hole needle plate is installed.

This message is displayed when the needle plate is removed with the machine on or when the machine is turned on and embroidery or embroidery edit mode is selected.



This message is displayed when the machine needs to be maintained. (page 187)



This message is displayed when you try to combine more than 71 stitch patterns.

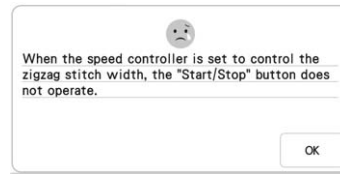

This message is displayed when the speed control lever is set to control the zigzag stitch width, and the “Start/ Stop” button is pushed. Use the foot controller to operate the machine.



This message is displayed when the automatic needle threading button is pushed while twin needle sewing is set.

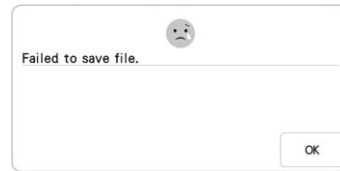

This message appears when you try to save more than 100 camera image or settings screen image files in the USB media. In this case, delete a file from the USB media or use different USB media. (page 32)

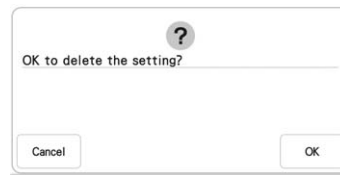

This message appears when or is pressed to delete the settings for a utility stitch. To delete the selected settings, press .



This message is displayed when the stitch patterns you are editing take up too much memory, or if you are editing too many stitch patterns for the memory.



This message is displayed when a key on the LCD display is touched while the needle is in the down position.

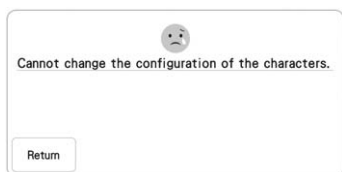

This message is displayed when there are too many characters and the curved character configuration is impossible.



This message is displayed when the upper thread is broken or not threaded correctly, and the "Start/Stop" button or the "Reverse/ Reinforcement Stitch" button is pressed.

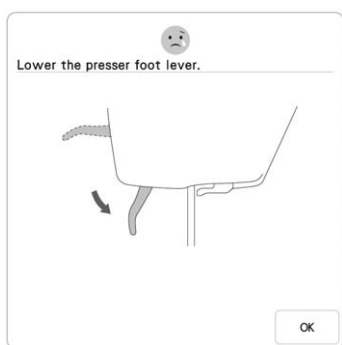

This message is displayed when the "Presser Foot Lifter" button is pushed while the presser foot lever is raised/the needle is lowered.



This message is displayed when the "Start/Stop" button is pushed to sew utility stitches or character/ decorative stitches while the foot controller is connected.

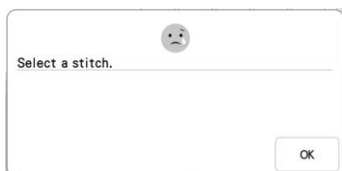

This message is displayed when there is no stitch pattern selected and the "Start/Stop" button or the "Reverse/Reinforcement Stitch" button is pressed.



This message is displayed when the bobbin thread is running out.

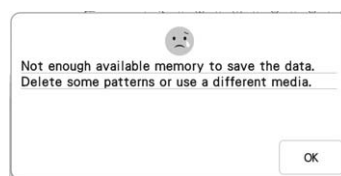

This message is displayed when the memory is full and the stitch pattern or embroidery pattern cannot be saved.

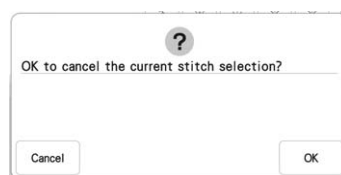

This message is displayed when, after selecting a stitch pattern, the Utility Stitch button, the Character Decorative Stitch button, or the Home button is pressed and the stitch pattern is about to be deleted.



This message is displayed when the bobbin is being wound, and the motor locks because the thread is tangled, etc.

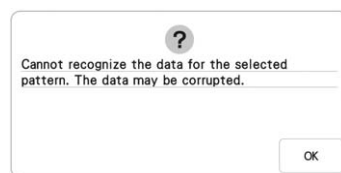

This message is displayed when there is a possibility that the data for the selected stitch pattern is corrupted.



This message is displayed when you try to use incompatible media.



This message is displayed when you attempt to select a stitch pattern after the USB media in which the stitch pattern is saved has been changed.

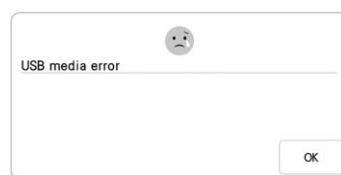

This message is displayed when an error occurs with the USB media.



This message is displayed when the memory is full and a stitch pattern must be deleted.

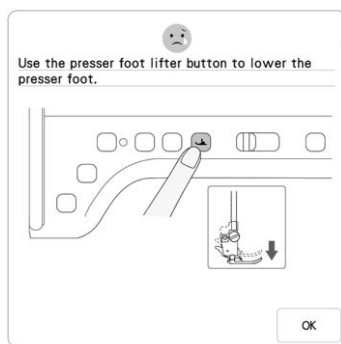

This message is displayed when a button, such as the “Start/Stop” button, is pushed while the presser foot is raised.



This message is displayed when it seems that the upper thread has not been threaded correctly.

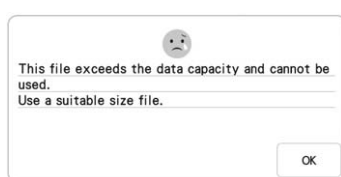

This message is displayed when the file size exceeds the data capacity of the machine. Confirm the file size and format. (page 35.)



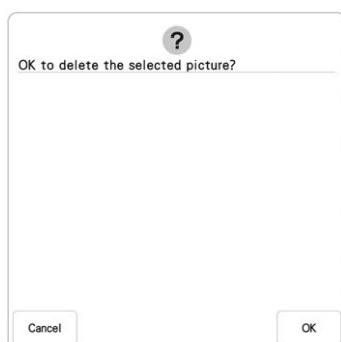

This message appears if the file format is incompatible with this machine. Check the list of compatible file formats. (page 35.)



This message is displayed when the image is deleted.



This message is displayed when you press  Sewing Guide in the screen other than the utility stitch, or press  Pattern Explanation in the screen other than the utility stitch or character/ decorative stitch.

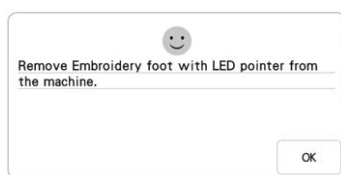

This message appears when you try to start sewing utility stitches or character/ decorative stitches with the embroidery foot with the LED pointer attached to the machine. Remove the embroidery foot with the LED pointer before entering the sewing mode.

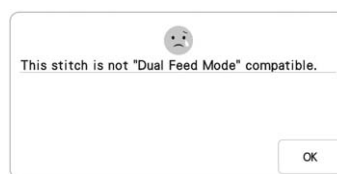

This message appears when the dual feed foot cannot be used with the current stitch. Select other stitch.

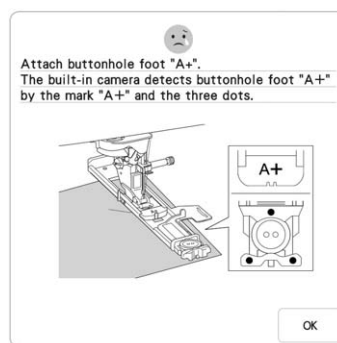

This message appears when start sewing buttonhole stitches without attaching buttonhole foot “A+”.

Alarm Sounds

If the operation was performed incorrectly, an alarm sounds to indicate that an error occurred. If the operation was performed correctly, the machine beeps to confirm the operation.

Memo

- To cancel the operation beep or to change the volume, press , display page 4 of the General settings screen, and then change the setting for “Machine Speaker Volume”. Refer to page 29 for more details.

SPECIFICATIONS

	Item	Specification
Machine (Box 1 of 2)	Dimensions of machine	Approx. 690 mm (W) × 349 mm (H) × 322 mm (D) (approx. 27-11/64 inches (W) × 13-47/64 inches (H) × 12-43/64 inches (D))
	Dimensions of box	Approx. 805 mm (W) × 510 mm (H) × 405 mm (D) (approx. 31-11/16 inches (W) × 20-5/64 inches (H) × 15-15/16 inches (D))
	Weight of machine	Approx. 19.6 kg (approx. 43.2 lb)
	Weight of box (for shipping)	Approx. 23.0 kg (approx. 50.7 lb)
	Sewing speed	70 to 1050 stitches per minute
	Needles	Home sewing machine needles (HA × 130)
Embroidery Unit (Box 2 of 2)	Dimensions of embroidery unit	Approx. 637 mm (W) × 150 mm (H) × 576 mm (D) (approx. 25-5/64 inches (W) × 5-29/32 inches (H) × 22-43/64 inches (D))
	Dimensions of machine with embroidery unit attached	Approx. 973 mm (W) × 349 mm (H) × 576 mm (D) (approx. 38-5/16 inches (W) × 13-47/64 inches (H) × 22-43/64 inches (D))
	Dimensions of box	Approx. 800 mm (W) × 695 mm (H) × 205 mm (D) (approx. 31-1/2 inches (W) × 27-23/64 inches (H) × 8-5/64 inches (D))
	Weight of embroidery unit	Approx. 5.6 kg (approx. 12.3 lb)
	Weight of box (for shipping)	Approx. 9.2 kg (approx. 20.3 lb)
Total Shipping Weight (Combination of all 2 boxes complete)		Approx. 43.4 kg (approx. 95.7 lb)
Data storage		USB media/SD card (SD and SDHC)

* Please be aware that some specifications may change without notice.

UPGRADING YOUR MACHINE'S SOFTWARE

You can use USB media to upgrade software for your machine. When an upgrade program is available on "www.babylock.com", please download the files following the instructions on the website and steps below.



Note

- When using USB media to upgrade the software, check that no data other than the upgrade file is saved on the USB media being used before starting to upgrade.
- Compatible operating systems:
Windows 7, Windows 8.1, Windows 10

Upgrade Procedure Using USB Media

- 1** While pressing the "Automatic Threading" button, turn the main power to ON.

→ The following screen will appear on the LCD.

- 2** Press  or .

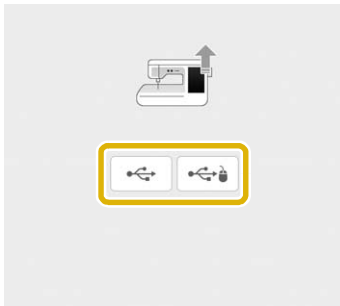

- 3** Insert the USB media into the USB port corresponding to the button pressed in step 2. USB port on the machine. The media device should only contain the upgrade file.

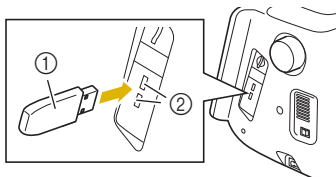

- ① USB media
② USB port



Note

- The access lamp will begin blinking after inserting USB media, and it will take about 5 to 6 seconds to recognize the media. (Time will differ depending on the USB media).

- 4** Press .

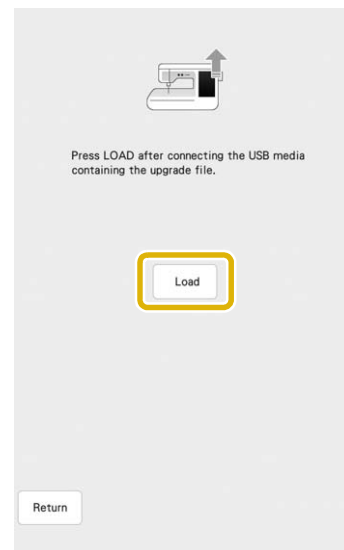

→ The upgrade file is loaded.



Note

- If an error occurs, a red text error message will appear. When the installation is performed successfully, following message will appear.



- 5** Remove the USB media, and turn the machine off and on again.

5

Appendix

STITCH SETTING CHART

















































The following chart shows information for each utility stitch concerning applications, stitch lengths, stitch widths, and whether or not the twin needle mode can be used.

























































































Note





















































- Quilting foot “C” is used when the straight stitch needle plate is attached to the machine. Refer to “Using Free motion Quilting Foot “C”” on page 126.











































Stitch	Stitch name	Presser foot		Applications	Stitch width [mm (inch)]		Stitch length [mm (inch)]		Twin needle
					Auto.	Manual	Auto.	Manual	
	Straight stitch (Left)			General sewing, gather, pintuck, etc. Reverse stitch is sewn while pressing “Reverse/Reinforcement Stitch” button.	0.0 (0)	0.0 - 7.0 (0 - 9/32)	2.5 (3/32)	0.2 - 5.0 (1/64 - 13/64)	OK (J)
	Straight stitch (Left)			General sewing, gather, pintuck, etc. Reinforcement stitch is sewn while pressing “Reverse/Reinforcement Stitch” button.	0.0 (0)	0.0 - 7.0 (0 - 9/32)	2.5 (3/32)	0.2 - 5.0 (1/64 - 13/64)	OK (J)
	Straight stitch (Middle)			General sewing, gather, pintuck, etc. Reverse stitch is sewn while pressing “Reverse/Reinforcement Stitch” button.	3.5 (9/64)	0.0 - 7.0 (0 - 9/32)	2.5 (3/32)	0.2 - 5.0 (1/64 - 13/64)	OK (J)
	Straight stitch (Middle)			General sewing, gather, pintuck, etc. Reinforcement stitch is sewn while pressing “Reverse/Reinforcement Stitch” button.	3.5 (9/64)	0.0 - 7.0 (0 - 9/32)	2.5 (3/32)	0.2 - 5.0 (1/64 - 13/64)	OK (J)
	Triple stretch stitch			General sewing for reinforcement and decorative topstitching	0.0 (0)	0.0 - 7.0 (0 - 9/32)	2.5 (3/32)	0.4 - 5.0 (1/64 - 13/64)	OK (J)
	Stem stitch			Reinforced stitching, sewing and decorative applications	1.0 (3/64)	0.0 - 7.0 (0 - 9/32)	2.5 (3/32)	0.4 - 5.0 (1/64 - 13/64)	OK (J)
	Decorative stitch			Decorative stitching, top stitching	0.0 (0)	0.0 - 7.0 (0 - 9/32)	2.5 (3/32)	0.4 - 5.0 (1/64 - 13/64)	OK (J)
	Basting stitch			Basting	0.0 (0)	0.0 - 7.0 (0 - 9/32)	20 (25/32)	5.0 (13/64)	NO
	Zigzag stitch			For overcasting, mending. Reverse stitch is sewn while pressing “Reverse/Reinforcement Stitch” button.	3.5 (9/64)	0.0 - 7.0 (0 - 9/32)	1.4 (1/16)	0.0 - 5.0 (0 - 13/64)	OK (J)
	Zigzag stitch			For overcasting, mending. Reinforcement stitch is sewn while pressing “Reverse/Reinforcement Stitch” button.	3.5 (9/64)	0.0 - 7.0 (0 - 9/32)	1.4 (1/16)	0.0 - 5.0 (0 - 13/64)	OK (J)
	Zigzag stitch (Right)			Start from right needle position, zigzag sew at left.	3.5 (9/64)	2.5 - 5.0 (3/32 - 13/64)	1.4 (1/16)	0.3 - 5.0 (1/64 - 13/64)	OK (J)
	Zigzag stitch (Left)			Start from left needle position, zigzag sew at right.	3.5 (9/64)	2.5 - 5.0 (3/32 - 13/64)	1.4 (1/16)	0.3 - 5.0 (1/64 - 13/64)	OK (J)
	2 steps elastic zigzag			Overcasting (medium weight and stretch fabrics), tape and elastic	5.0 (13/64)	0.0 - 7.0 (0 - 9/32)	1.0 (3/64)	0.2 - 5.0 (1/64 - 13/64)	OK (J)























































Stitch	Stitch name	Presser foot		Applications	Stitch width [mm (inch)]		Stitch length [mm (inch)]		Twin needle
					Auto.	Manual	Auto.	Manual	
	2 steps elastic zigzag			Overcasting (medium weight and stretch fabrics), tape and elastic	5.0 (13/64)	0.0 - 7.0 (0 - 9/32)	1.0 (3/64)	0.2 - 5.0 (1/64 - 13/64)	OK (J)
	3 steps elastic zigzag			Overcasting (medium, heavyweight and stretch fabrics), tape and elastic	5.0 (13/64)	0.0 - 7.0 (0 - 9/32)	1.0 (3/64)	0.2 - 5.0 (1/64 - 13/64)	OK (J)
	Overcasting stitch			Reinforcing of light and medium weight fabrics	3.5 (9/64)	2.5 - 5.0 (3/32 - 13/64)	2.0 (5/64)	0.4 - 5.0 (1/64 - 13/64)	NO
	Overcasting stitch			Reinforcing of heavyweight fabric	5.0 (13/64)	2.5 - 5.0 (3/32 - 13/64)	2.5 (3/32)	0.4 - 5.0 (1/64 - 13/64)	NO
	Overcasting stitch			Reinforcing of medium, heavyweight and easily friable fabrics or decorative stitching.	5.0 (13/64)	3.5 - 5.0 (9/64 - 13/64)	2.5 (3/32)	0.4 - 5.0 (1/64 - 13/64)	NO
	Overcasting stitch			Reinforced seaming of stretch fabric	5.0 (13/64)	0.0 - 7.0 (0 - 9/32)	2.5 (3/32)	0.4 - 5.0 (1/64 - 13/64)	OK (J)
	Overcasting stitch			Reinforcing of medium stretch fabric and heavyweight fabric, decorative stitching	5.0 (13/64)	0.0 - 7.0 (0 - 9/32)	2.5 (3/32)	0.4 - 5.0 (1/64 - 13/64)	OK (J)
	Overcasting stitch			Reinforcement of stretch fabric or decorative stitching	4.0 (5/32)	0.0 - 7.0 (0 - 9/32)	4.0 (5/32)	0.4 - 5.0 (1/64 - 13/64)	OK (J)
	Overcasting stitch			Stretch knit seam	5.0 (13/64)	0.0 - 7.0 (0 - 9/32)	4.0 (5/32)	0.4 - 5.0 (1/64 - 13/64)	NO
	Single diamond overcast			Reinforcement and seaming stretch fabric	6.0 (15/64)	0.0 - 7.0 (0 - 9/32)	3.0 (1/8)	0.4 - 5.0 (1/64 - 13/64)	OK (J)
	Single diamond overcast			Reinforcement of stretch fabric	6.0 (15/64)	0.0 - 7.0 (0 - 9/32)	1.8 (1/16)	0.4 - 5.0 (1/64 - 13/64)	OK (J)
	With side cutter			Straight stitch while cutting fabrics	0.0 (0)	0.0 - 2.5 (0 - 3/32)	2.5 (3/32)	0.2 - 5.0 (1/64 - 13/64)	NO
	With side cutter			Zigzag stitch while cutting fabrics	3.5 (9/64)	3.5 - 5.0 (9/64 - 13/64)	1.4 (1/16)	0.0 - 5.0 (0 - 13/64)	NO
	With side cutter			Overcasting stitch while cutting fabrics	3.5 (9/64)	3.5 - 5.0 (9/64 - 13/64)	2.0 (5/64)	0.4 - 5.0 (1/64 - 13/64)	NO
	With side cutter			Overcasting stitch while cutting fabrics	5.0 (13/64)	3.5 - 5.0 (9/64 - 13/64)	2.5 (3/32)	0.4 - 5.0 (1/64 - 13/64)	NO
	With side cutter			Overcasting stitch while cutting fabrics	5.0 (13/64)	3.5 - 5.0 (9/64 - 13/64)	2.5 (3/32)	0.4 - 5.0 (1/64 - 13/64)	NO
	Piecing stitch (Right)			Piecing/patchwork 6.5 mm (approx. 1/4 inch) right seam allowance	5.5 (7/32)	0.0 - 7.0 (0 - 9/32)	2.0 (5/64)	0.2 - 5.0 (1/64 - 13/64)	NO
	Piecing stitch (Middle)			Piecing/patchwork	—	—	2.0 (5/64)	0.2 - 5.0 (1/64 - 13/64)	NO

























































Stitch	Stitch name	Presser foot		Applications	Stitch width [mm (inch)]		Stitch length [mm (inch)]		Twin needle
					Auto.	Manual	Auto.	Manual	
	Piecing stitch (Left)			Piecing/patchwork 6.5 mm (approx. 1/4 inch) left seam allowance	1.5 (1/16)	0.0 - 7.0 (0 - 9/32)	2.0 (5/64)	0.2 - 5.0 (1/64 - 13/64)	NO
	Hand-look quilting			Quilting stitch made to look like hand quilting stitch	0.0 (0)	0.0 - 7.0 (0 - 9/32)	2.5 (3/32)	0.4 - 5.0 (1/64 - 13/64)	NO
	Quilting appliqué zigzag stitch			Zigzag stitch for quilting and sewing on appliqué quilt pieces	3.5 (9/64)	0.0 - 7.0 (0 - 9/32)	1.4 (1/16)	0.0 - 5.0 (0 - 13/64)	NO
	Quilting appliqué stitch			Quilting stitch for invisible appliqué or attaching binding	1.5 (1/16)	0.0 - 7.0 (0 - 9/32)	1.8 (1/16)	0.4 - 5.0 (1/64 - 13/64)	NO
	Quilting stippling			Background quilting	7.0 (9/32)	0.0 - 7.0 (0 - 9/32)	1.6 (1/16)	0.4 - 5.0 (1/64 - 13/64)	NO
	Blind hem stitch			Hemming woven fabrics	0.0 (0)	+3.0 - -3.0 (+1/8 - -1/8)	2.0 (5/64)	0.4 - 5.0 (1/64 - 13/64)	NO
	Blind hem stitch stretch			Hemming stretch fabric	0.0 (0)	+3.0 - -3.0 (+1/8 - -1/8)	2.0 (5/64)	0.4 - 5.0 (1/64 - 13/64)	NO
	Blanket stitch			Appliqués, decorative blanket stitch	3.5 (9/64)	0.0 - 7.0 (0 - 9/32)	2.5 (3/32)	0.4 - 5.0 (1/64 - 13/64)	OK (J)
	Blanket stitch			Appliqués, decorative blanket stitch	2.5 (3/32)	0.0 - 7.0 (0 - 9/32)	2.5 (3/32)	0.4 - 5.0 (1/64 - 13/64)	OK (J)
	Shell tuck edge			Shell tuck edge finish on fabrics	4.0 (5/32)	0.0 - 7.0 (0 - 9/32)	2.5 (3/32)	0.2 - 5.0 (1/64 - 13/64)	OK (J)
	Satin scallop stitch			Decorating collar of blouse, edge of handkerchief	5.0 (13/64)	0.0 - 7.0 (0 - 9/32)	0.5 (1/64)	0.1 - 5.0 (0 - 13/64)	OK (J)
	Scallop stitch			Decorating collar of blouse, edge of handkerchief	7.0 (9/32)	0.0 - 7.0 (0 - 9/32)	1.4 (1/16)	0.4 - 5.0 (1/64 - 13/64)	NO
	Patchwork join stitch			Patchwork stitches, decorative stitching	4.0 (5/32)	0.0 - 7.0 (0 - 9/32)	1.2 (1/16)	0.2 - 5.0 (1/64 - 13/64)	OK (J)
	Patchwork double overlock stitch			Patchwork stitches, decorative stitching	5.0 (13/64)	0.0 - 7.0 (0 - 9/32)	2.5 (3/32)	0.4 - 5.0 (1/64 - 13/64)	OK (J)
	Couching stitch			Decorative stitching, attaching cord and couching	5.0 (13/64)	0.0 - 7.0 (0 - 9/32)	1.2 (1/16)	0.2 - 5.0 (1/64 - 13/64)	OK (J)
	Smocking stitch			Smocking, decorative stitching	5.0 (13/64)	0.0 - 7.0 (0 - 9/32)	1.6 (1/16)	0.4 - 5.0 (1/64 - 13/64)	OK (J)
	Feather stitch			Fagoting, decorative stitching	5.0 (13/64)	0.0 - 7.0 (0 - 9/32)	2.5 (3/32)	0.4 - 5.0 (1/64 - 13/64)	OK (J)
	Fagoting cross stitch			Fagoting, bridging and decorative stitching	5.0 (13/64)	0.0 - 7.0 (0 - 9/32)	2.5 (3/32)	0.4 - 5.0 (1/64 - 13/64)	OK (J)
	Tape attaching			Attaching tape to seam in stretch fabric	4.0 (5/32)	0.0 - 7.0 (0 - 9/32)	1.0 (3/64)	0.2 - 5.0 (1/64 - 13/64)	OK (J)

































Stitch	Stitch name	Presser foot		Applications	Stitch width [mm (inch)]		Stitch length [mm (inch)]		Twin needle
					Auto.	Manual	Auto.	Manual	
	Ladder stitch			Decorative stitching	4.0 (5/32)	0.0 - 7.0 (0 - 9/32)	3.0 (1/8)	0.4 - 5.0 (1/64 - 13/64)	NO
	Rick-rack stitch			Decorative top stitching	4.0 (5/32)	0.0 - 7.0 (0 - 9/32)	2.5 (3/32)	0.4 - 5.0 (1/64 - 13/64)	OK (J)
	Decorative stitch			Decorative stitching	1.0 (3/64)	0.0 - 7.0 (0 - 9/32)	2.5 (3/32)	0.4 - 5.0 (1/64 - 13/64)	OK (J)
	Decorative stitch			Decorative stitching	5.5 (7/32)	0.0 - 7.0 (0 - 9/32)	1.6 (1/16)	0.4 - 5.0 (1/64 - 13/64)	OK (J)
	Serpentine stitch			Decorative stitching and attaching elastic	5.0 (13/64)	0.0 - 7.0 (0 - 9/32)	1.0 (3/64)	0.2 - 5.0 (1/64 - 13/64)	OK (J)
	Decorative stitch			Decorative stitching and appliqué	6.0 (15/64)	0.0 - 7.0 (0 - 9/32)	1.0 (3/64)	0.2 - 5.0 (1/64 - 13/64)	OK (J)
	Decorative stippling stitch			Decorative stitching	7.0 (9/32)	0.0 - 7.0 (0 - 9/32)	1.6 (1/16)	0.4 - 5.0 (1/64 - 13/64)	NO
	Hemstitching			Decorative hems, triple straight at left	1.0 (3/64)	0.0 - 7.0 (0 - 9/32)	2.5 (3/32)	0.4 - 5.0 (1/64 - 13/64)	OK (J)
	Hemstitching			Decorative hems, triple straight at center	3.5 (9/64)	0.0 - 7.0 (0 - 9/32)	2.5 (3/32)	0.4 - 5.0 (1/64 - 13/64)	OK (J)
	Hemstitching zigzag			Decorative hems, top stitching	6.0 (15/64)	0.0 - 7.0 (0 - 9/32)	3.0 (1/8)	0.4 - 5.0 (1/64 - 13/64)	OK (J)
	Hemstitching			Decorative hems, lace attaching pin stitch	3.5 (9/64)	0.0 - 7.0 (0 - 9/32)	2.5 (3/32)	0.4 - 5.0 (1/64 - 13/64)	NO
	Hemstitching			Decorative hems	3.0 (1/8)	0.0 - 7.0 (0 - 9/32)	3.5 (9/64)	0.4 - 5.0 (1/64 - 13/64)	NO
	Hemstitching			Decorative hems daisy stitch	6.0 (15/64)	0.0 - 7.0 (0 - 9/32)	3.0 (1/8)	0.4 - 5.0 (1/64 - 13/64)	NO
	Hemstitching			Heirloom, decorative hems	5.0 (13/64)	0.0 - 7.0 (0 - 9/32)	3.5 (9/64)	0.4 - 5.0 (1/64 - 13/64)	NO
	Hemstitching			Heirloom, decorative hems	5.0 (13/64)	0.0 - 7.0 (0 - 9/32)	3.5 (9/64)	0.4 - 5.0 (1/64 - 13/64)	NO
	Hemstitching			Heirloom, decorative hems	5.0 (13/64)	0.0 - 7.0 (0 - 9/32)	3.5 (9/64)	0.4 - 5.0 (1/64 - 13/64)	OK (J)
	Hemstitching			Heirloom, decorative hems	5.0 (13/64)	0.0 - 7.0 (0 - 9/32)	4.0 (5/32)	0.4 - 5.0 (1/64 - 13/64)	OK (J)
	Hemstitching			Heirloom, decorative hems	4.0 (5/32)	0.0 - 7.0 (0 - 9/32)	2.5 (3/32)	0.4 - 5.0 (1/64 - 13/64)	OK (J)

Stitch	Stitch name	Presser foot		Applications	Stitch width [mm (inch)]		Stitch length [mm (inch)]		Twin needle
					Auto.	Manual	Auto.	Manual	
	Honeycomb stitch			Heirloom, decorative hems	5.0 (13/64)	0.0 - 7.0 (0 - 9/32)	2.5 (3/32)	0.4 - 5.0 (1/64 - 13/64)	OK (J)
	Honeycomb stitch			Heirloom, decorative hems	6.0 (15/64)	0.0 - 7.0 (0 - 9/32)	3.5 (9/64)	0.4 - 5.0 (1/64 - 13/64)	OK (J)
	Hemstitching			Heirloom, decorative hems	6.0 (15/64)	0.0 - 7.0 (0 - 9/32)	1.6 (1/16)	0.4 - 5.0 (1/64 - 13/64)	OK (J)
	Hemstitching			Heirloom, decorative hems	6.0 (15/64)	0.0 - 7.0 (0 - 9/32)	3.0 (1/8)	0.4 - 5.0 (1/64 - 13/64)	NO
	Hemstitching			Heirloom, decorative hems	6.0 (15/64)	0.0 - 7.0 (0 - 9/32)	4.0 (5/32)	0.4 - 5.0 (1/64 - 13/64)	OK (J)
	Hemstitching			Heirloom, decorative hems	4.0 (5/32)	0.0 - 7.0 (0 - 9/32)	2.5 (3/32)	0.4 - 5.0 (1/64 - 13/64)	NO
	Hemstitching			Heirloom, decorative hems	5.0 (13/64)	0.0 - 7.0 (0 - 9/32)	2.0 (5/64)	0.4 - 5.0 (1/64 - 13/64)	OK (J)
	Hemstitching			Decorative hems and bridging stitch	6.0 (15/64)	0.0 - 7.0 (0 - 9/32)	2.0 (5/64)	0.4 - 5.0 (1/64 - 13/64)	OK (J)
	Hemstitching			Decorative hems. Fagoting, attaching ribbon	5.0 (13/64)	0.0 - 7.0 (0 - 9/32)	3.0 (1/8)	0.4 - 5.0 (1/64 - 13/64)	OK (J)
	Hemstitching			Decorative hems, smocking	6.0 (15/64)	0.0 - 7.0 (0 - 9/32)	1.6 (1/16)	0.4 - 5.0 (1/64 - 13/64)	NO
	Hemstitching			Decorative hems, smocking	5.0 (13/64)	0.0 - 7.0 (0 - 9/32)	1.6 (1/16)	0.4 - 5.0 (1/16 - 13/64)	NO
	Hemstitching			Decorative hems, smocking	5.0 (13/64)	0.0 - 7.0 (0 - 9/32)	1.6 (1/16)	0.4 - 5.0 (1/64 - 13/64)	NO
	Hemstitching			Decorative hems	5.0 (13/64)	0.0 - 7.0 (0 - 9/32)	1.6 (1/16)	0.4 - 5.0 (1/64 - 13/64)	NO
	Ladder stitch			Decorative hems. Fagoting, attaching ribbon	7.0 (9/32)	0.0 - 7.0 (0 - 9/32)	1.6 (1/16)	0.4 - 2.5 (1/64 - 3/32)	NO
	Narrow rounded buttonhole			Buttonhole on light to medium weight fabrics	5.0 (13/64)	3.0 - 6.5 (1/8 - 1/4)	0.4 (1/64)	0.2 - 1.0 (1/64 - 3/64)	NO
	Wide round ended buttonhole			Buttonholes with extra space for larger buttons	5.5 (7/32)	3.5 - 6.5 (9/64 - 1/4)	0.4 (1/64)	0.2 - 1.0 (1/64 - 3/64)	NO
	Tapered round ended buttonhole			Reinforced waist tapered buttonholes	5.0 (13/64)	3.0 - 6.5 (1/8 - 1/4)	0.4 (1/64)	0.2 - 1.0 (1/64 - 3/64)	NO
	Round ended buttonhole			Buttonholes with vertical bar tack in heavyweight fabrics	5.0 (13/64)	3.0 - 6.5 (1/8 - 1/4)	0.4 (1/64)	0.2 - 1.0 (1/64 - 3/64)	NO

Stitch	Stitch name	Presser foot		Applications	Stitch width [mm (inch)]		Stitch length [mm (inch)]		Twin needle
					Auto.	Manual	Auto.	Manual	
	Round ended buttonhole			Buttonholes with bar tack	5.0 (13/64)	3.0 - 6.5 (1/8 - 1/4)	0.4 (1/64)	0.2 - 1.0 (1/64 - 3/64)	NO
	Round double ended buttonhole			Buttonholes for fine, medium to heavyweight fabrics	5.0 (13/64)	3.0 - 6.5 (1/8 - 1/4)	0.4 (1/64)	0.2 - 1.0 (1/64 - 3/64)	NO
	Narrow squared buttonhole			Buttonholes for light to medium weight fabrics	5.0 (13/64)	3.0 - 6.5 (1/8 - 1/4)	0.4 (1/64)	0.2 - 1.0 (1/64 - 3/64)	NO
	Wide squared buttonhole			Buttonholes with extra space for larger decorative buttons	5.5 (7/32)	3.5 - 6.5 (9/64 - 1/4)	0.4 (1/64)	0.2 - 1.0 (1/64 - 3/64)	NO
	Squared buttonhole			Heavy-duty buttonholes with vertical bar tacks	5.0 (13/64)	3.0 - 6.5 (1/8 - 1/4)	0.4 (1/64)	0.2 - 1.0 (1/64 - 3/64)	NO
	Stretch buttonhole			Buttonholes for stretch or woven fabrics	6.0 (15/64)	3.0 - 6.5 (1/8 - 1/4)	1.0 (3/64)	0.5 - 2.0 (1/64 - 5/64)	NO
	Heirloom buttonhole			Buttonholes for heirloom and stretch fabrics	6.0 (15/64)	3.0 - 6.5 (1/8 - 1/4)	1.5 (1/16)	1.0 - 3.0 (3/64 - 1/8)	NO
	Bound buttonhole			The first step in making bound buttonholes	5.0 (13/64)	0.0 - 6.5 (0 - 1/4)	2.0 (5/64)	0.2 - 4.0 (1/64 - 5/32)	NO
	Keyhole buttonhole			Buttonholes in heavyweight or thick fabrics for larger flat buttons	7.0 (9/32)	3.0 - 7.0 (1/8 - 9/32)	0.5 (1/64)	0.3 - 1.0 (1/64 - 3/64)	NO
	Tapered keyhole buttonhole			Buttonholes in medium to heavy weight fabrics for larger flat buttons	7.0 (9/32)	3.0 - 7.0 (1/8 - 9/32)	0.5 (1/64)	0.3 - 1.0 (1/64 - 3/64)	NO
	Keyhole buttonhole			Buttonholes with vertical bar tack for reinforcement in heavyweight or thick fabrics	7.0 (9/32)	3.0 - 7.0 (1/8 - 9/32)	0.5 (1/64)	0.3 - 1.0 (1/64 - 3/64)	NO
	4 steps buttonhole 1			Left side of 4 step buttonhole	5.0 (13/64)	1.5 - 7.0 (1/16 - 9/32)	0.4 (1/64)	0.2 - 1.0 (1/64 - 3/64)	NO
	4 steps buttonhole 2			Bar tack of 4 step buttonhole	5.0 (13/64)	1.5 - 7.0 (1/16 - 9/32)	0.4 (1/64)	0.2 - 1.0 (1/64 - 3/64)	NO
	4 steps buttonhole 3			Right side of 4 step buttonhole	5.0 (13/64)	1.5 - 7.0 (1/16 - 9/32)	0.4 (1/64)	0.2 - 1.0 (1/64 - 3/64)	NO
	4 steps buttonhole 4			Bar tack of 4 step buttonhole	5.0 (13/64)	1.5 - 7.0 (1/16 - 9/32)	0.4 (1/64)	0.2 - 1.0 (1/64 - 3/64)	NO
	Darning			Darning of medium weight fabric	7.0 (9/32)	2.5 - 7.0 (3/32 - 9/32)	2.0 (5/64)	0.4 - 2.5 (1/64 - 3/32)	NO
	Darning			Darning of heavyweight fabric	7.0 (9/32)	2.5 - 7.0 (3/32 - 9/32)	2.0 (5/64)	0.4 - 2.5 (1/64 - 3/32)	NO
	Bar tack			Reinforcement at opening of pocket, etc.	2.0 (5/64)	1.0 - 3.0 (3/64 - 1/8)	0.4 (1/64)	0.3 - 1.0 (1/64 - 3/64)	NO

Stitch	Stitch name	Presser foot		Applications	Stitch width [mm (inch)]		Stitch length [mm (inch)]		Twin needle
					Auto.	Manual	Auto.	Manual	
	Button sewing			Attaching buttons	3.5 (9/64)	2.5 - 4.5 (3/32 - 11/64)	—	—	NO
	Eyelet			For making eyelets, holes on belts, etc.	7.0 (9/32)	7.0 6.0 5.0 (9/32 15/64 13/64)	7.0 (9/32)	7.0 6.0 5.0 (9/32 15/64 13/64)	NO
	Star eyelet			For making star-shaped eyelets on holes.	—	—	—	—	NO
	Diagonally left up (Straight)			For attaching appliqué on tubular pieces of fabric and mitering corners	—	—	—	—	NO
	Reverse (Straight)			For attaching appliqué on tubular pieces of fabric and mitering corners	—	—	—	—	NO
	Diagonally right up (Straight)			For attaching appliqué on tubular pieces of fabric and mitering corners	—	—	—	—	NO
	Sideways to left (Straight)			For attaching appliqué on tubular pieces of fabric	—	—	—	—	NO
	Sideways to right (Straight)			For attaching appliqué on tubular pieces of fabric	—	—	—	—	NO
	Diagonally left down (Straight)			For attaching appliqué on tubular pieces of fabric and mitering corners	—	—	—	—	NO
	Forward (Straight)			For attaching appliqué on tubular pieces of fabric and mitering corners	—	—	—	—	NO
	Diagonally right down (Straight)			For attaching appliqué on tubular pieces of fabric and mitering corners	—	—	—	—	NO
	Sideways to left (Zigzag)			For attaching appliqué on tubular pieces of fabric	—	—	—	—	NO
	Sideways to right (Zigzag)			For attaching appliqué on tubular pieces of fabric	—	—	—	—	NO
	Forward (Zigzag)			For attaching appliqué on tubular pieces of fabric and mitering corners	—	—	—	—	NO
	Reverse (Zigzag)			For attaching appliqué on tubular pieces of fabric and mitering corners	—	—	—	—	NO
	Piecing stitch (Middle)			Piecingwork/patchwork	—	—	2.0 (5/64)	0.2 - 5.0 (1/64 - 13/64)	NO
	Piecing stitch (Right)			Piecingwork/patchwork 6.5 mm (approx. 1/4 inch) right seam allowance	5.50 (7/32)	0.00 - 7.00 (0 - 9/32)	2.0 (5/64)	0.2 - 5.0 (1/64 - 13/64)	NO
	Piecing stitch (Left)			Piecingwork/patchwork 6.5 mm (approx. 1/4 inch) left seam allowance	1.50 (1/16)	0.00 - 7.00 (0 - 9/32)	2.0 (5/64)	0.2 - 5.0 (1/64 - 13/64)	NO

Stitch	Stitch name	Presser foot		Applications	Stitch width [mm (inch)]		Stitch length [mm (inch)]		Twin needle
					Auto.	Manual	Auto.	Manual	
	Hand-look quilting			Quilting stitch made to look like hand quilting stitch	3.50 (9/64)	0.00 - 7.00 (0 - 9/32)	2.5 (3/32)	0.4 - 5.0 (1/64 - 13/64)	NO
	Basting stitch			Basting	3.50 (9/64)	0.00 - 7.00 (0 - 9/32)	20 (25/32)	5 - 30 (13/64 - 1-3/16)	NO
	Stem stitch			Reinforced stitching, sewing and decorative applications	1.00 (3/64)	0.00 - 7.00 (0 - 9/32)	2.5 (3/32)	0.4 - 5.0 (1/64 - 13/64)	NO
	Quilting appliqué zigzag stitch			Zigzag stitch for quilting and sewing on appliqué quilt pieces	3.50 (9/64)	0.00 - 7.00 (0 - 9/32)	1.6 (1/16)	0.0 - 5.0 (0 - 13/64)	NO
	Zigzag stitch (Right)			Start from right needle position, zigzag sew at left	3.50 (9/64)	2.50 - 5.00 (3/32 - 13/64)	1.6 (1/16)	0.3 - 5.0 (1/64 - 13/64)	NO
	Zigzag stitch (Left)			Start from left needle position, zigzag sew at right	3.50 (9/64)	2.50 - 5.00 (3/32 - 13/64)	1.6 (1/16)	0.3 - 5.0 (1/64 - 13/64)	NO
	2 steps elastic zigzag			Overcasting (medium weight and stretch fabrics), tape and elastic	5.00 (13/64)	0.00 - 7.00 (0 - 9/32)	1.0 (3/64)	0.2 - 5.0 (1/64 - 13/64)	NO
	3 steps elastic zigzag			Overcasting (medium, heavyweight and stretch fabrics), tape and elastic	5.00 (13/64)	0.00 - 7.00 (0 - 9/32)	1.0 (3/64)	0.2 - 5.0 (1/64 - 13/64)	NO
	Quilting appliqué stitch			Quilting stitch for invisible appliqué or attaching binding	2.00 (5/64)	0.00 - 7.00 (0 - 9/32)	2.0 (5/64)	0.4 - 5.0 (1/64 - 13/64)	NO
	Shell tuck edge			Shell tuck edge finish on fabrics	4.00 (5/32)	0.00 - 7.00 (0 - 9/32)	2.5 (3/32)	0.2 - 5.0 (1/64 - 13/64)	NO
	Blanket stitch			Appliqués, decorative blanket stitch	3.50 (9/64)	0.00 - 7.00 (0 - 9/32)	2.5 (3/32)	0.4 - 5.0 (1/64 - 13/64)	NO
	Quilting stippling			Background quilting	7.00 (9/32)	0.00 - 7.00 (0 - 9/32)	1.6 (1/16)	0.4 - 5.0 (1/64 - 13/64)	NO
	Overcasting stitch			Stretch knit seam	5.00 (13/64)	0.00 - 7.00 (0 - 9/32)	4.0 (5/32)	0.4 - 5.0 (1/64 - 13/64)	NO
	Tape attaching			Attaching tape to seam in stretch fabric	5.50 (7/32)	0.00 - 7.00 (0 - 9/32)	1.4 (1/16)	0.2 - 5.0 (1/64 - 13/64)	NO
	Serpentine stitch			Decorative stitching and attaching elastic	5.00 (13/64)	0.00 - 7.00 (0 - 9/32)	2.0 (5/64)	0.2 - 5.0 (1/64 - 13/64)	NO
	Feather stitch			Fagoting, decorative stitching	5.00 (13/64)	0.00 - 7.00 (0 - 9/32)	2.5 (3/32)	0.4 - 5.0 (1/64 - 13/64)	NO
	Fagoting cross stitch			Fagoting, bridging and decorative stitching	5.00 (13/64)	0.00 - 7.00 (0 - 9/32)	2.5 (3/32)	0.4 - 5.0 (1/64 - 13/64)	NO
	Couching stitch			Decorative stitching, attaching cord and couching	5.00 (13/64)	0.00 - 7.00 (0 - 9/32)	1.2 (1/16)	0.2 - 5.0 (1/64 - 13/64)	NO

Stitch	Stitch name	Presser foot		Applications	Stitch width [mm (inch)]		Stitch length [mm (inch)]		Twin needle
					Auto.	Manual	Auto.	Manual	
	Patchwork double overlock stitch			Patchwork stitches, decorative stitching	5.00 (13/64)	0.00 - 7.00 (0 - 9/32)	2.5 (3/32)	0.4 - 5.0 (1/64 - 13/64)	NO
	Smocking stitch			Smocking, decorative stitching	5.00 (13/64)	0.00 - 7.00 (0 - 9/32)	1.6 (1/16)	0.4 - 5.0 (1/64 - 13/64)	NO
	Rick-rack stitch			Decorative top stitching	4.00 (5/32)	0.00 - 7.00 (0 - 9/32)	2.5 (3/32)	0.4 - 5.0 (1/64 - 13/64)	NO
	Decorative stitch			Decorative stitching and appliqué	6.00 (15/64)	0.00 - 7.00 (0 - 9/32)	1.0 (3/64)	0.2 - 5.0 (1/64 - 13/64)	NO
	Decorative stitch			Decorative stitching	5.50 (7/32)	0.00 - 7.00 (0 - 9/32)	1.6 (1/16)	0.4 - 5.0 (1/64 - 13/64)	NO
	Hemstitching			Heirloom, decorative hems	5.00 (13/64)	0.00 - 7.00 (0 - 9/32)	2.0 (5/64)	0.4 - 5.0 (1/64 - 13/64)	NO
	Hemstitching			Decorative hems and bridging stitch	6.00 (15/64)	0.00 - 7.00 (0 - 9/32)	2.0 (5/64)	0.4 - 5.0 (1/64 - 13/64)	NO
	Single diamond overcast			Reinforcement and seaming stretch fabric	6.00 (15/64)	0.00 - 7.00 (0 - 9/32)	3.0 (1/8)	0.4 - 5.0 (1/64 - 13/64)	NO
	Overcasting stitch			Reinforcement of stretch fabric or decorative stitching	4.00 (5/32)	0.00 - 7.00 (0 - 9/32)	4.0 (5/32)	0.4 - 5.0 (1/64 - 13/64)	NO
	Free motion couching stitch			Free motion couching stitch	3.50 (9/64)	2.75 - 3.75 (3/32 - 1/8)	-	-	NO
	Basting stitch			Free motion basting stitch	3.50 (9/64)	0.00 - 7.00 (0 - 9/32)	-	-	NO

INDEX

A

Accessories	
included accessories	17
options	20
Accessory case	16
Accessory compartment	16
Air vent	12
Alarm sounds	202
Alphabet characters	
character/decorative stitches	160
Appliqué	133
quilting	124
using a zigzag stitch	116
Automatic fabric sensor system	91
Automatic reinforcement stitching	79
Automatic thread cutting key	88
Automatic Threading button	15, 61

B

Back to beginning key	170
Ball point needle	71
Ball point needle 75/107	71
Bar tacks	148
Basting	140
Blind hem stitches	131
Bobbin	
pulling up the bobbin thread	59
setting	58
winding	52
Bobbin case	
cleaning	184
Bobbin cover	14, 58
Bobbin winder	12
Bobbin winding switch	54
Built-in camera	93, 95
Button sewing	149
4 hole buttons	150
shank	150
Buttonholes	
four-step	145
odd-shaped/buttons that do not fit the button holder plate	144
one-step	141

C

Character/Decorative Stitches	
adjustments	164
combining	172
editing	166
key functions	166
retrieving	180, 181
saving	179
selecting	158
sewing	163
stitch selection screens	159
Cleaning	
LCD screen	184
machine casing	184
race	184
Clock	26
Combining stitch patterns	
character/decorative stitches	172
Cord guide bobbin cover	117
Crazy quilt	116

D

Darning	147
---------	-----

Dart seam	112
Dual feed foot	74, 123
Dual purpose stylus	94
Dual purpose stylus holder	95

E

Echo quilting	129
Eco mode	34
Editing	
character/decorative stitches	166
Elastic zigzag stitches	117
Elongation key	169
Embroidery unit	15
carriage	15
Error messages	200
Eyelet	150

F

Fabrics	
fabric/thread/needle combinations	71
sewing heavyweight fabrics	82
sewing lightweight fabrics	84
sewing stretch fabrics	84, 143
Fagoting	137
Feed dogs	14, 126
Flat bed attachment	12
Flat fell Seam	113
Foot controller	12, 78
Free motion quilting	
free motion echo quilting foot "E"	129
free motion open toe quilting foot "O"	128
free motion quilting foot "C"	126
Free motion sewing mode	126

G

Gathering	113
-----------	-----

H

Handle	12
Handwheel	13
Heirloom	138
Hemstitching	
daisy stitch	138
drawn work	139
Home page screen	27

I

Image key	106, 171
Innov-eye Technology (for U.S.A. only)	93

K

Key functions	
character/decorative stitches	166
utility stitches	103
Knee lifter	12, 90

L

L/R Shift	86
LCD screen	12, 27
cleaning	184
light	29
Lower threading	
pulling up the bobbin thread	59

- setting the bobbin 58
- winding the bobbin 52

M

- Machine help key 38
- Machine operation mode key 195
- Main power switch 12, 25
- Mirror image key 105, 169
- MPEG-4 (MP4) videos 42
- Multi-directional sewing 151
- Multi-function foot controller 33
- Multi-purpose screwdriver 23
- Muvit (for U.S.A. only) 74

N

- Needle
 - changing the needle 69
 - changing the needle position 110
 - checking the needle location 92
 - fabric/thread/needle combinations 71
 - twin needle 64
- Needle bar thread guides 14, 65
- Needle calibration 36
- Needle clamp screw 14
- Needle mode selection key 64
- Needle plate 14
- Needle position 92, 110
- Needle Position button 15

O

- Operation buttons 12, 15
- Overcasting 116, 118

P

- Patchwork 116
- Piecing 123
- Pintuck 114
- Pivoting 89
- Power cord 26
- Power cord receptacle 12
- Presser foot
 - attaching 72
 - pressure 91
 - removing 72
 - types 206
- Presser foot holder 14, 72
- Presser foot holder screw 14
- Presser foot lever 12, 83
- Presser Foot Lifter button 15
- Presser foot/Needle exchange key 64, 69, 72
- Pretension disk 12, 53, 56
- Projector 94, 96

Q

- Quilting 121
 - free motion 126
 - with satin stitches 125

R

- Race 184
- Reinforcement stitch 79
- Reinforcement Stitch button 79
- Retrieving
 - character/decorative stitch patterns 180
 - machine's memory 180
 - stitch settings 107
 - USB media 181
 - utility stitches 107
- Reverse Stitch button 79

- Reverse/Reinforcement Stitch button 15, 79
- Reverse/Reinforcement stitches 79

S

- Satin stitches 125, 170
- Saving
 - character/decorative stitches 179
 - machine's memory 179
 - stitch settings 107
 - USB media 179
 - utility stitches 107
- Scallop stitches 135
- Screen saver 35
- SD card
 - usable 178
- Settings
 - automatic thread cutting 88
 - embroidery settings 31
 - general settings 29
 - machine setting mode key 28
 - sewing settings 28
 - stitch length 86
 - stitch width 85
 - thread tension 87
- Sewing speed controller (speed control slide) 12, 15, 77
- Sewing type selection key 40
- Shelltuck stitches 134
- Shutoff support mode 34
- Side cutter 119
- Single/Repeat sewing key 169
- Size selection key 169
- Smocking stitches 136
- Speaker 29
- Specifications 203
- Spool cap 12
- Spool net 68
- Spool pin 12
- Spool stand 56, 66
- Start/Stop button 15
- Step stitch patterns 175
- Stitch setting chart 206
- StitchVision Technology (for U.S.A. only) 94
- Straight stitch foot 111
- Straight stitch needle plate 111
- Straight stitches 108
- Supplemental spool pin 12, 52, 65

T

- Tape attaching 117
- Tape or elastic attaching 137
- Thread
 - fabric/thread/needle combinations 71
 - thread tension 87
- Thread cutter 12, 78
- Thread Cutter button 15
- Thread density key 170
- Thread guide 12, 53, 56, 65
- Thread guide plate 12, 56, 61
- Top cover 12
- Top stitching 135
- Transparent nylon thread 71
- Troubleshooting 188
- Tutorial video 41
- Twin needle 64

U

- Up Close Viewer (for U.S.A. only) 93
- Upgrading 204
- Upper threading
 - twin needle mode 64
 - using the "Automatic Threading" button 61
 - using the spool net 68

USB media	
recalling	181
saving	179
usable	178
USB mouse	48
USB port connector	
for media	13, 179
Utility stitches	
key functions	103
retrieving	107
saving	107
selecting	102
sewing type selection key	40
stitch pattern explanation key	43
stitch selection screens	104
stitch setting chart	206

W

Walking foot	73
--------------------	----

Z

Zigzag stitches	116
Zipper insertion	
centered	152
side	153

*Solaris*TM



FOR THE LOVE OF SEWING