

Meridian 2TM

Quick Reference Guide Guide de référence rapide

Model BLMA2



baby lock

FOR THE LOVE OF SEWING

To register your machine warranty and receive Baby Lock product updates and offers, go to babylock.com/login. If you have questions about registration, visit your Authorized Baby Lock Retailer.

Pour enregistrer la garantie de votre machine et recevoir les mises à jour et les offres des produits Baby Lock, rendez-vous sur babylock.com/profile. Si vous avez des questions concernant l'inscription, rendez-vous chez votre Revendeur Agréé Baby Lock.

Baby Lock Consumer Helpline: 800-313-4110

www.BabyLock.com

Refer to the Instruction and Reference Guide for detailed instructions.
 Also, there are differences in the keys and screens depending on the display language. In this guide, English screens are used for basic explanations.

Consulte las instrucciones detalladas en la guía de referencia y de instrucciones.
 Además, dependiendo del idioma visualizado algunos botones y pantallas podrán ser diferentes.
 En esta guía, para las explicaciones básicas se emplean pantallas en inglés.

Reportez-vous au guide d'instructions et de référence pour des informations détaillées.
 Par ailleurs, il y a des différences sur les touches et les écrans en fonction de la langue d'affichage.
 Dans ce guide, les explications de base utilisent les écrans en Anglais.

<English display>
<Visualización en inglés>
<Affichage en Anglais>

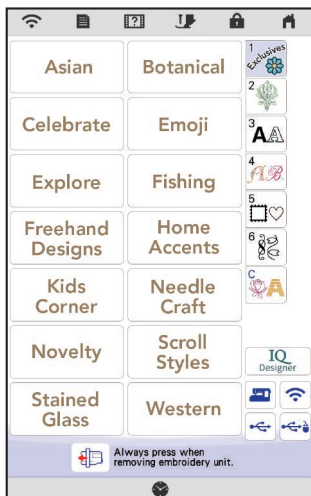

<Example: French>
<Ejemplo: Francés>
<Exemple : français>

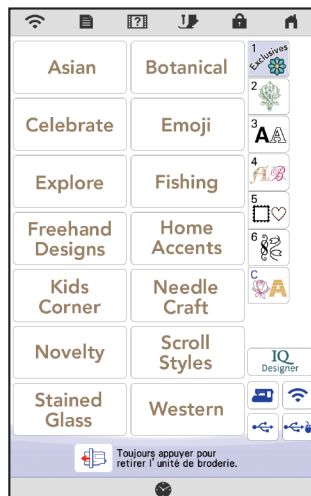

<Example: Spanish>
<Ejemplo: Español>
<Exemple : español>

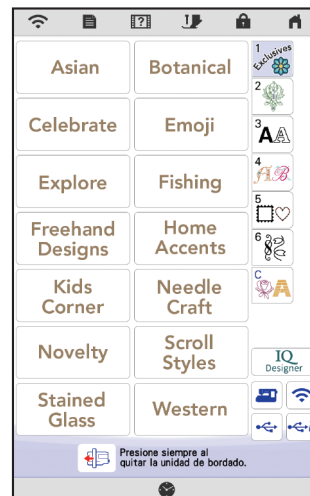

Contents

- 3 Wireless Network Connection Functions
- 5 Wireless Network Connection
- 7 Winding the Bobbin
- 10 Setting the Bobbin
- 11 Upper Threading
- 12 Preparing to Embroider
- 14 Selecting Embroidery Patterns

Contenido

- 3 Funciones de conexión de red inalámbrica
- 5 Conexión de red inalámbrica
- 7 Devanado de la bobina
- 10 Colocación de la bobina
- 11 Hilo superior
- 12 Preparativos para bordar
- 14 Seleccionar patrones de bordado

Table des matières

- 3 Fonctions de connexion au réseau sans fil
- 5 Connexion au réseau sans fil
- 7 Bobinage de la canette
- 10 Mise en place de la canette
- 11 Enfilage supérieur
- 12 Préparation de la broderie
- 14 Sélection des motifs de broderie

Wireless Network Connection Functions

Funciones de conexión de red inalámbrica

Fonctions de connexion au réseau sans fil

Operations Available with a Wireless Network Connection

This machine supports a wireless network connection. The following useful operations will be available if the machine is connected to a wireless network.

■ For updating

Directly download the update file to the machine.

Operaciones disponibles con una conexión de red inalámbrica

Esta máquina es compatible con una conexión de red inalámbrica. Las siguientes operaciones útiles estarán disponibles si la máquina está conectada a una red inalámbrica.

■ Para actualizar

Descargue directamente el archivo de actualización a la máquina.

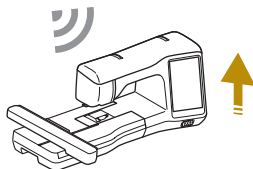

Opérations disponibles avec une connexion au réseau sans fil

Cette machine prend en charge une connexion à un réseau sans fil. Les opérations utiles suivantes seront disponibles si la machine est connectée à un réseau sans fil.

■ Pour mettre à jour

Téléchargez le fichier de mise à jour directement vers la machine.



■ For embroidering

■ Para bordar

■ Pour broder

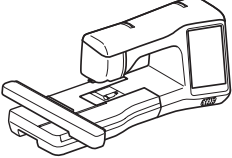
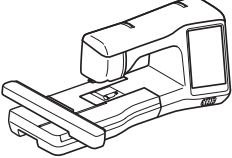
 	<p>IQ Intuition- Positioning</p> <p>With IQ Intuition- Positioning app, you can position your embroidery designs on the fabric by capturing image of the hooped fabric and sending the image to your machine. Please visit the following URL for more features and details. https://www.babylock.com/positioning_manual_2</p>	<p>Con la aplicación IQ Intuition- Positioning, podrá colocar sus diseños de bordado sobre la tela capturando la imagen de la tela colocada y enviándola a su máquina. Para más detalles acerca de las funciones, visite la siguiente URL: https://www.babylock.com/positioning_manual_2</p>	<p>Grâce à l'application IQ Intuition- Positioning, vous pouvez positionner vos motifs de broderie sur le tissu en capturant l'image du tissu se trouvant dans le cadre et en envoyant l'image à votre machine. Rendez-vous sur l'URL suivante pour plus de fonctions et de détails. https://www.babylock.com/positioning_manual_2</p>
	<p>IQ Intuition- Monitoring</p> <p>Conveniently check the operating status of the machine from your smart device by using IQ Intuition- Monitoring app.</p>	<p>Compruebe el estado operativo de la máquina desde su dispositivo inteligente utilizando la aplicación IQ Intuition- Monitoring.</p>	<p>L'application IQ Intuition- Monitoring vous permet de vérifier facilement l'état de fonctionnement de la machine depuis votre appareil mobile.</p>

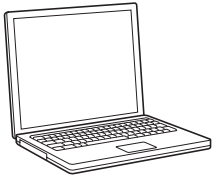
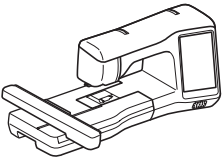
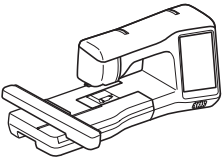
 	<p>Design Database Transfer</p> <p>Wirelessly transfer an embroidery pattern from your computer to the machine by using Design Database Transfer app. Please visit the following URL for more features and details. https://www.babylock.com/accessories/software/design-database-transfer</p>	<p>Transfiera de forma inalámbrica un patrón de bordado desde el ordenador a la máquina utilizando la aplicación Design Database Transfer. Para más detalles acerca de las funciones, visite la siguiente URL. https://www.babylock.com/accessories/software/design-database-transfer</p>	<p>Transférez sans fil un motif de broderie de votre ordinateur à la machine à l'aide de l'application Design Database Transfer. Consultez la page Web suivante pour plus de fonctions et de détails. https://www.babylock.com/accessories/software/design-database-transfer</p>
	<p>Palette</p> <p>Wirelessly transfer to the machine an embroidery pattern edited with embroidery editing software (Palette version 11 or later) on a computer. Also, transfer to Palette an embroidery pattern edited on the machine.</p>	<p>Transfiera de forma inalámbrica a la máquina un patrón de bordado editado con un programa de edición de bordados (Palette versión 11 o posterior) en un ordenador. Igualmente, transfiera a Palette un patrón de bordado editado en la máquina.</p>	<p>Transférez via le réseau sans fil vers la machine un motif de broderie modifié à l'aide d'un logiciel de broderie (Palette version 11 ou ultérieure) depuis un ordinateur. Transférez également vers Palette un motif de broderie modifié depuis la machine.</p>

For details on each function, refer to the Instruction and Reference Guide.

Si desea más información acerca de cada función, consulte el Manual de instrucciones.

Pour plus d'informations sur chaque fonction, reportez-vous au manuel d'instructions.

Wireless Network Connection

Conexión de red inalámbrica

Connexion au réseau sans fil



- When you first turn on the machine, the following message about a wireless LAN connection appears. To set up a connection, touch , and then continue with step **5** .

- Cuando se activa la máquina por primera vez, se muestra el siguiente mensaje acerca de una conexión de LAN inalámbrica. Para establecer una conexión, toque y continúe con el paso **5** .

- Quand vous mettez la machine sous tension pour la première fois, le message suivant apparaît à propos d'une connexion au réseau local LAN sans fil. Pour configurer une connexion, touchez , puis passez à l'étape **5** .

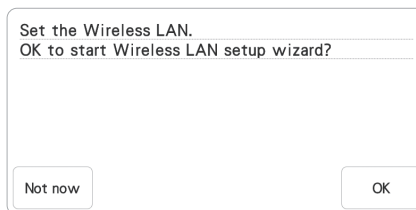

1



2

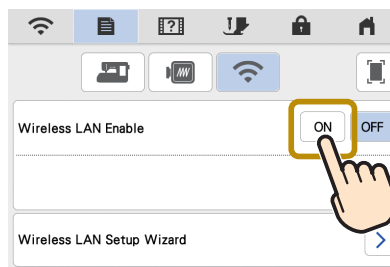

3

Find your security information (SSID and network key) and note it.

Busque su información de seguridad (SSID y clave de red) y anótela.

Recherchez vos informations de sécurité (SSID et clé réseau) et notez-les.

4

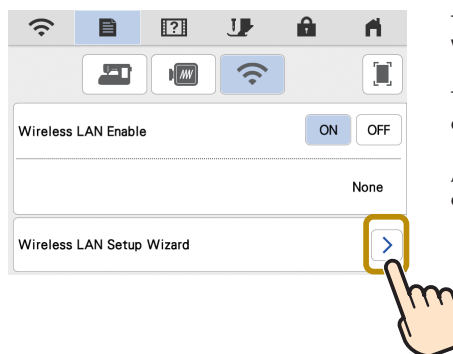

Touch **>** beside "Wireless LAN Setup Wizard".

Toque **>** junto a "Asistente de configuración de la LAN inalámbrica".

Appuyez sur **>** à côté de « Assistant de configuration du réseau local LAN sans fil ».



5

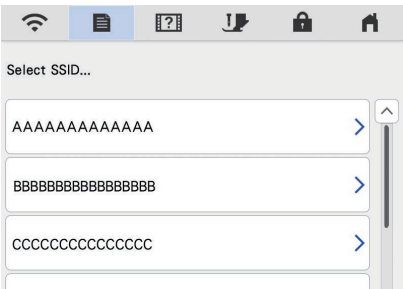

Select > beside the SSID that was noted in step 3.

Seleccione > junto al SSID que se ha anotado en el paso 3.

Sélectionnez > à côté du SSID que vous avez noté à l'étape 3.

6

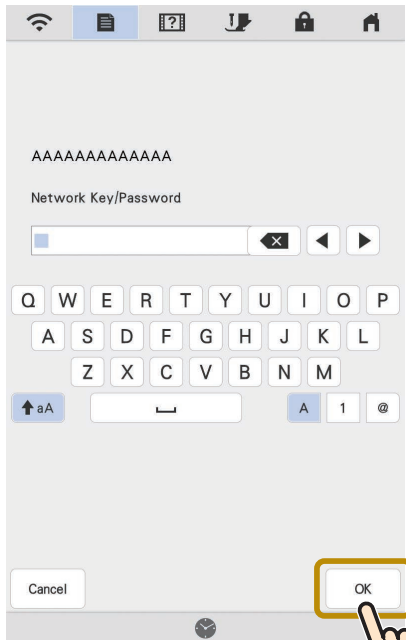

Enter the network key (password) that was noted in step 3 and then touch .

Introduzca la clave de red (contraseña) que anotó en el paso 3 y luego toque .

Saisissez la clé réseau (mot de passe) que vous avez notée à l'étape 3, puis touchez .

7

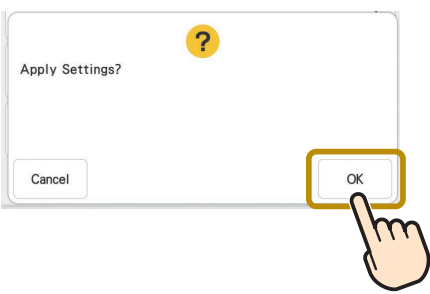

8

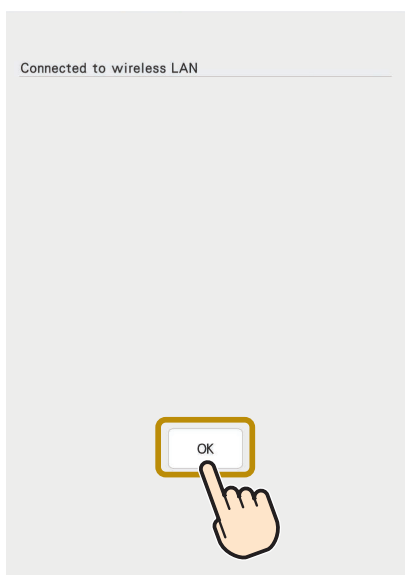

9

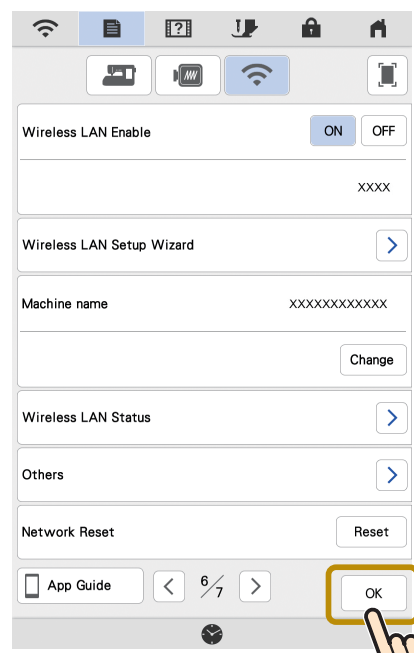

Winding the Bobbin

Devanado de la bobina

Bobinage de la canette

Follow the numbered steps below in order. Refer to the Instruction and Reference Guide for detailed instruction.

Realice los siguientes pasos numerados en el orden indicado. Para obtener instrucciones detalladas, consulte el guía de referencia y de instrucciones.

Suivez les étapes numérotées ci-dessous dans l'ordre. Consultez le guide d'instructions et de référence pour des procédures détaillées.

Use the plastic bobbin that comes with this machine or bobbins of the same type. Bobbin included with the machine is Class 15 type bobbin.

Utilice la bobina de plástico suministrada con esta máquina o bobinas del mismo tipo. La bobina incluida con la máquina es de Clase 15.

Utilisez la canette en plastique fournie avec cette machine ou des canettes du même type. La canette fournie avec la machine est de type Classe 15.

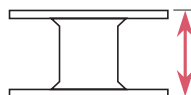

11.5 mm (approx. 7/16 inch)
11,5 mm (aprox. 7/16 pulg.)
11,5 mm (env. 7/16 po)

Using the Supplemental Spool Pin

You can wind the bobbin during embroidery.

Uso del portacarrete suplementario

Puede devanar la bobina mientras está bordando.

Utilisation du porte-bobine supplémentaire

Vous pouvez bobiner la canette pendant la broderie.

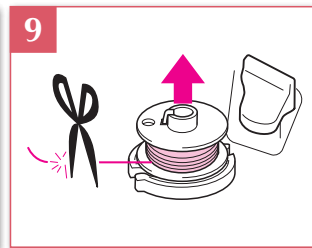
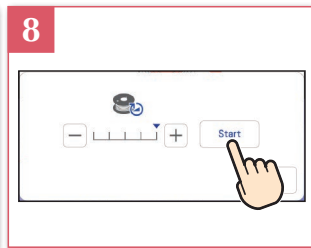
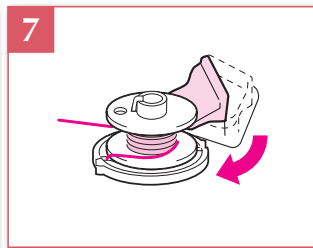
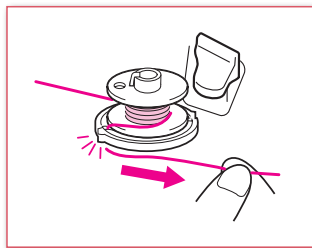
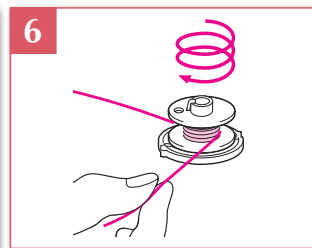
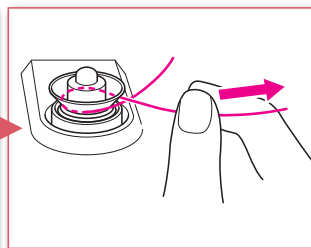
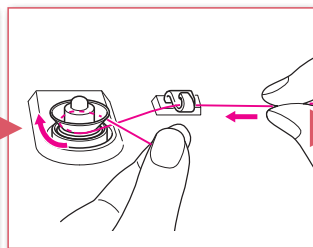
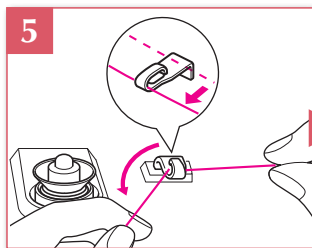
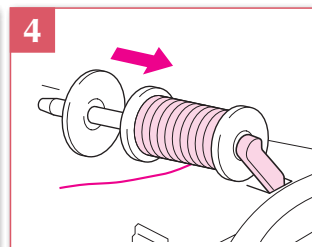
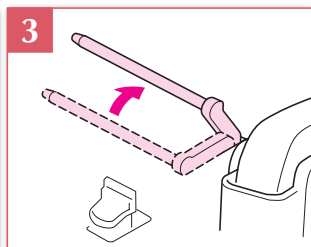
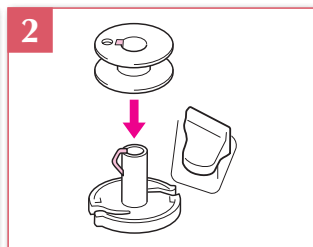
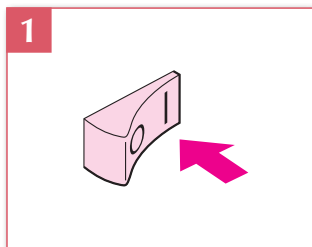
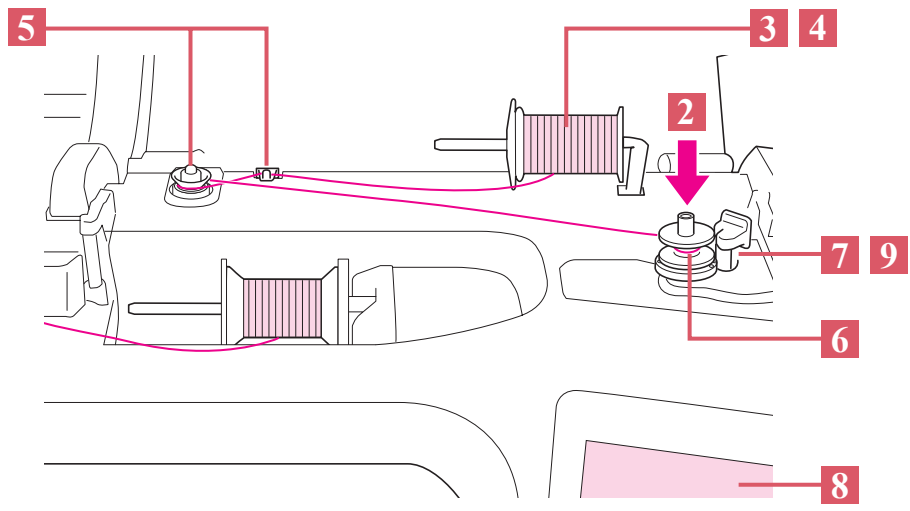

Winding the Bobbin Devanado de la bobina Bobinage de la canette

Using the Spool Pin

You can use the main spool pin to wind the bobbin before embroidering.

Uso del portacarrete

Se puede utilizar el portacarrete principal para devanar la bobina antes de bordar.

Utilisation du porte-bobine

Vous pouvez bobiner la canette avant de broder à l'aide du porte-bobine principal.

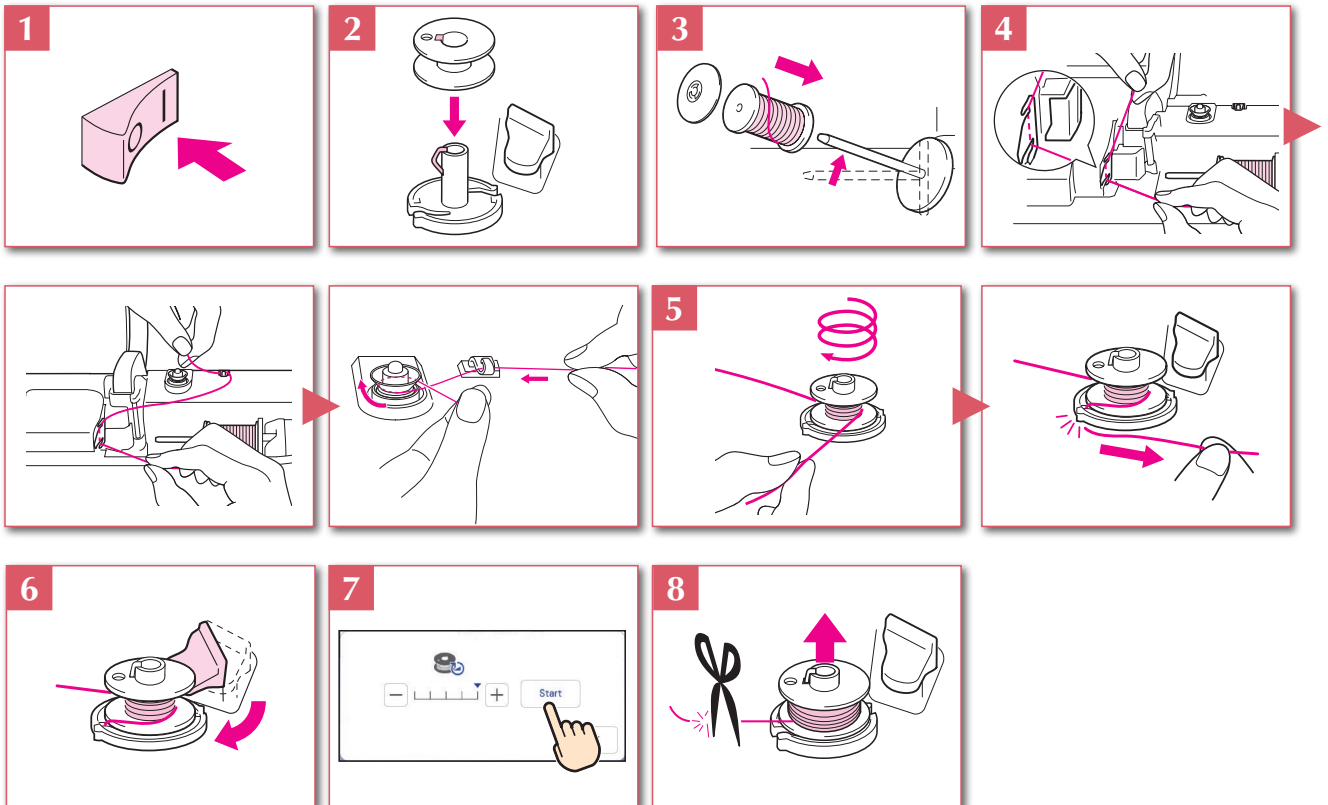
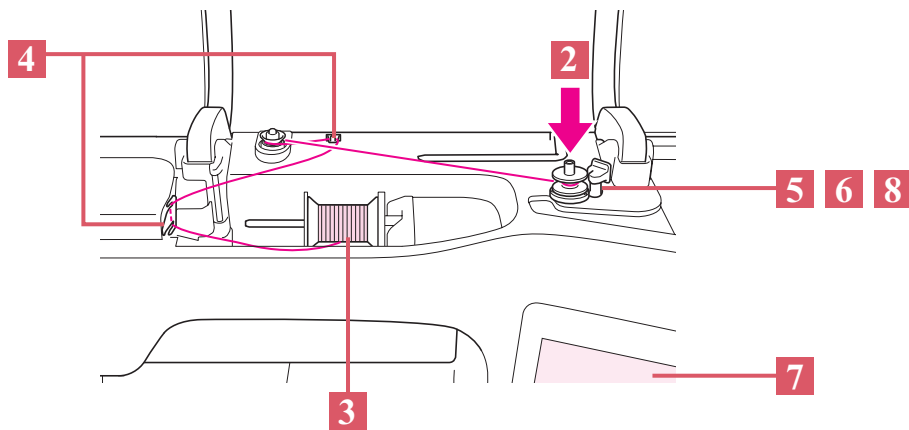

Setting the Bobbin

Colocación de la bobina

Mise en place de la canette

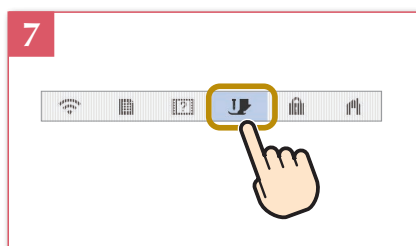
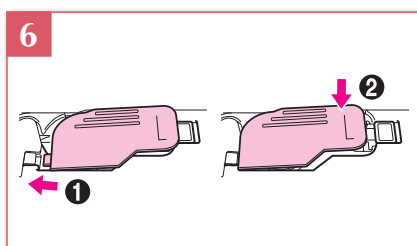
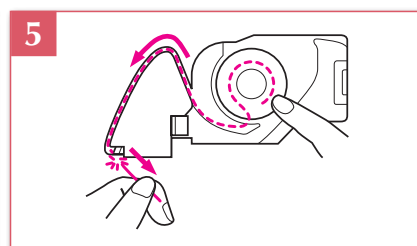
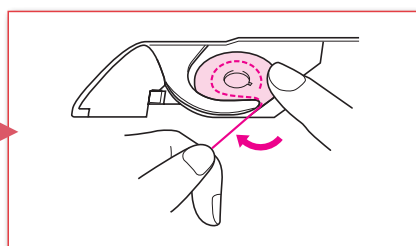
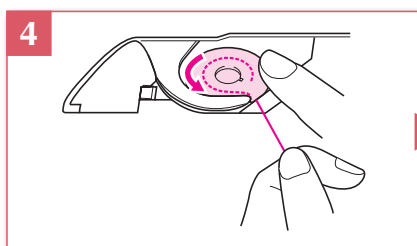
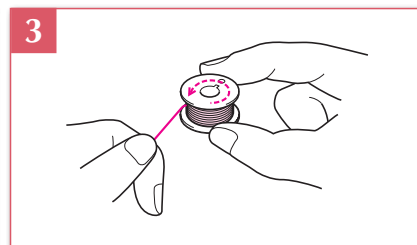
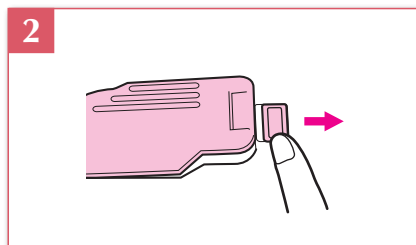
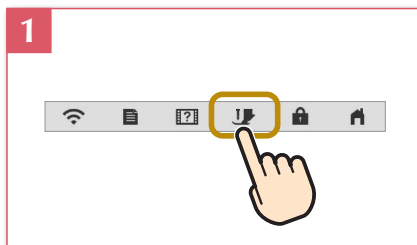

Upper Threading

Hilo superior

Enfilage supérieur

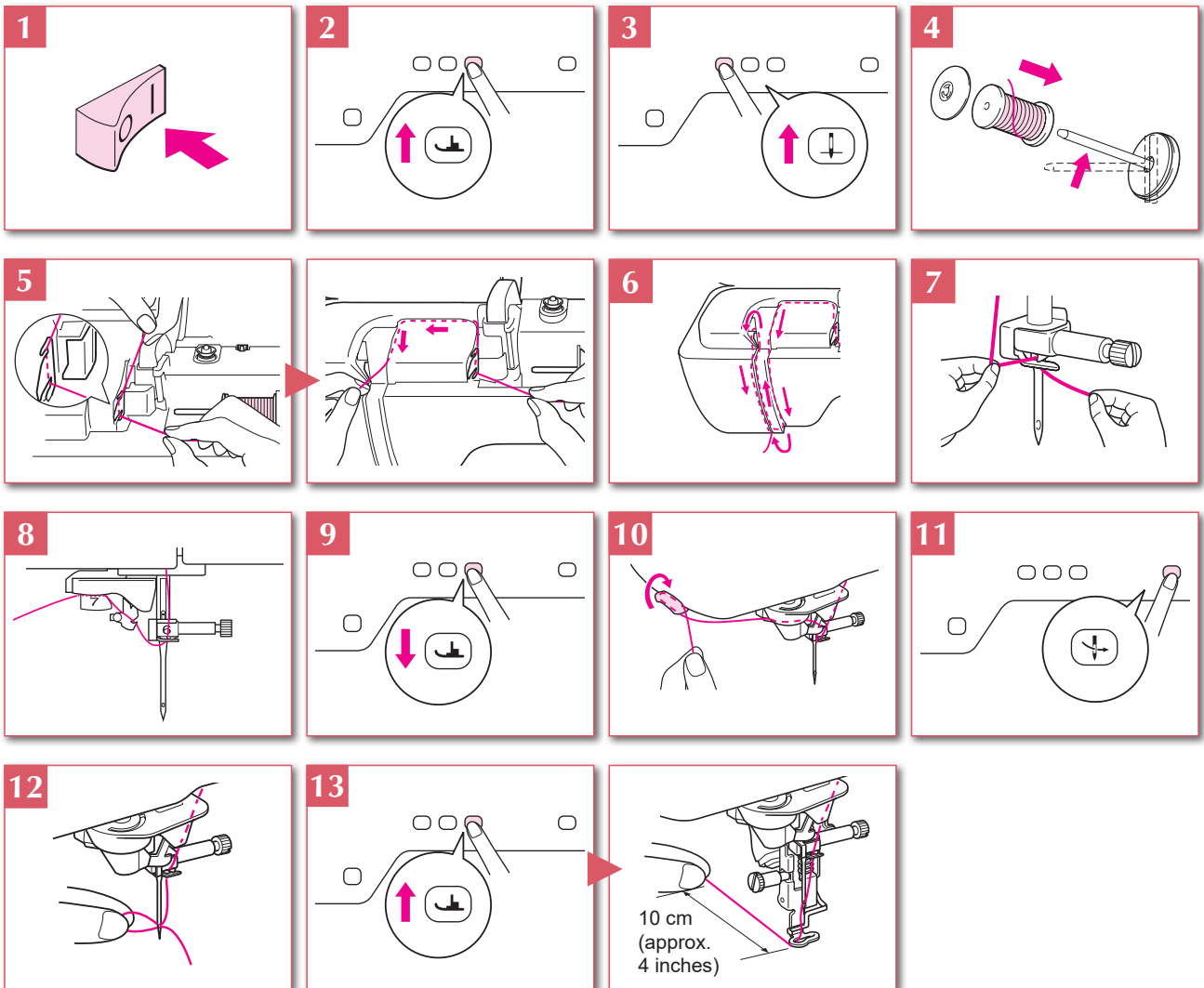
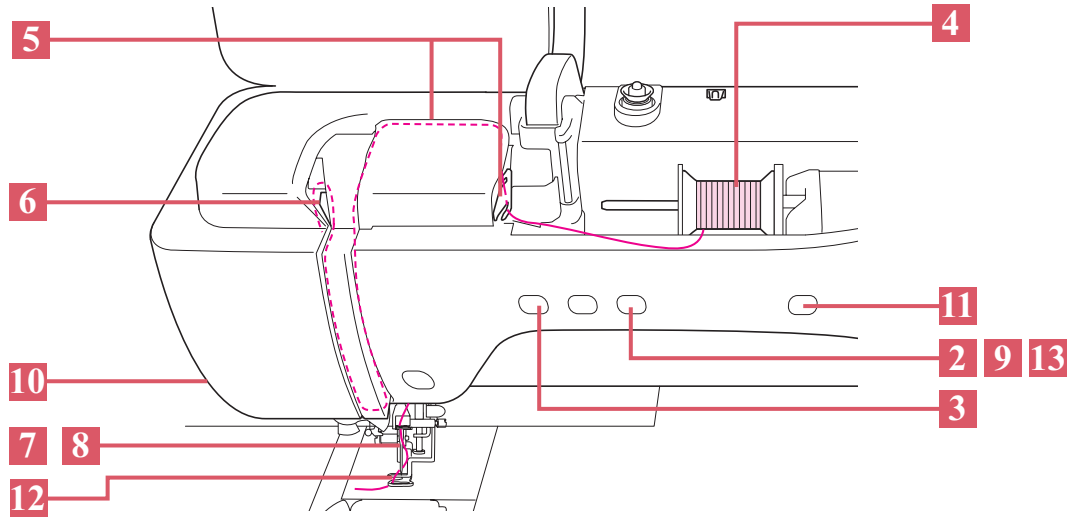

Preparing to Embroider

Preparativos para bordar

Préparation de la broderie

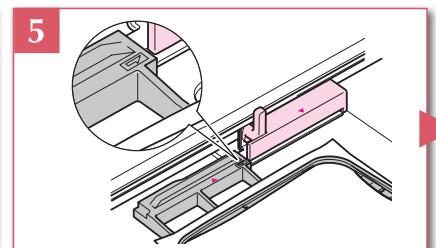
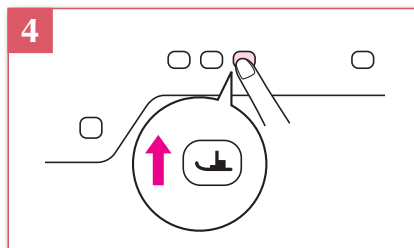
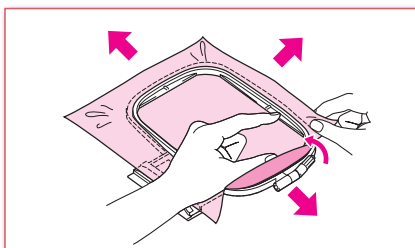
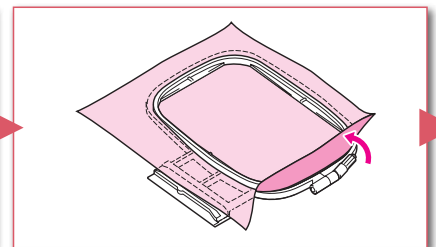
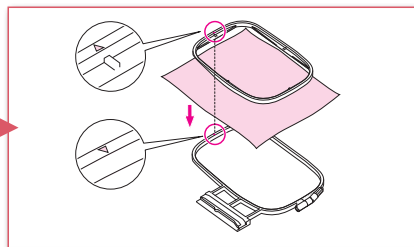
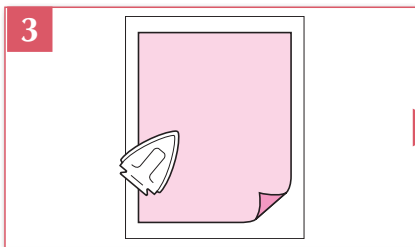
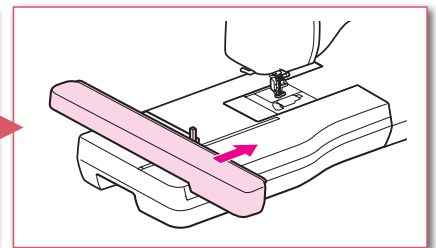
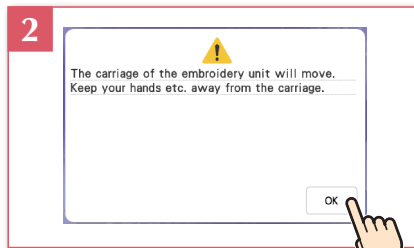
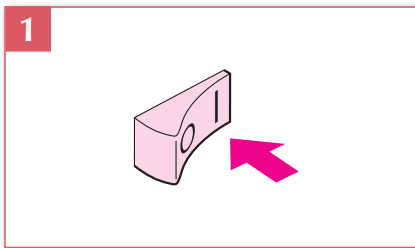
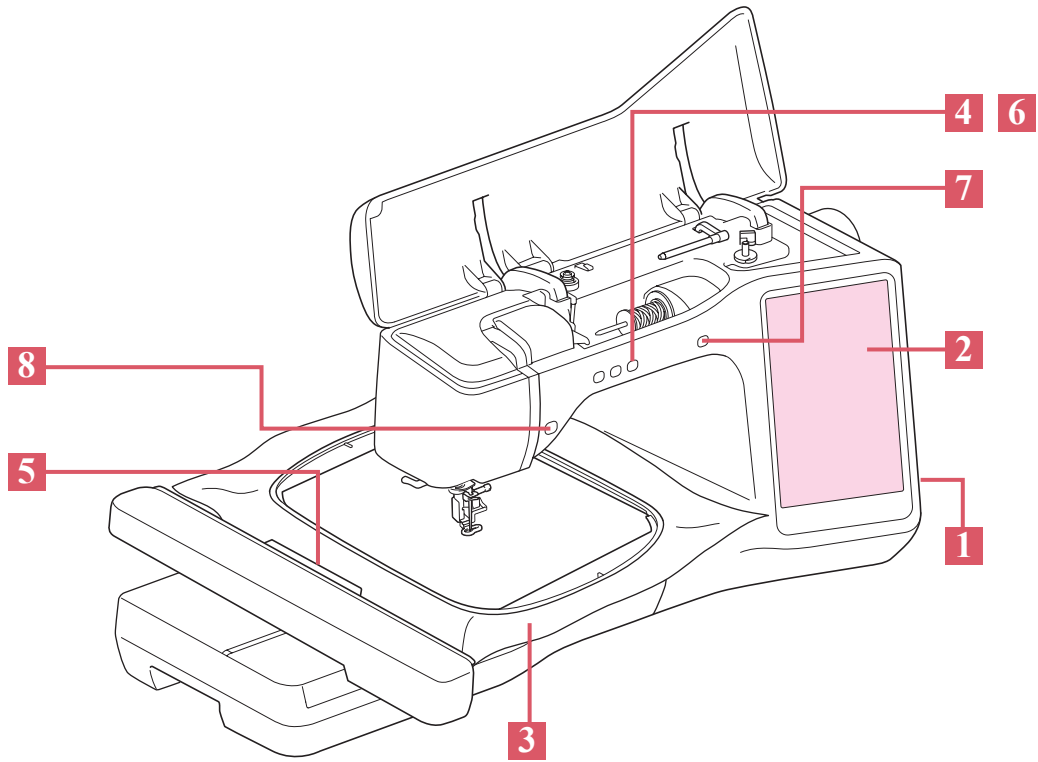

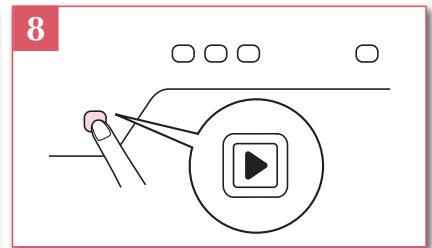
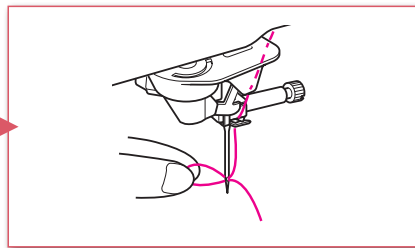
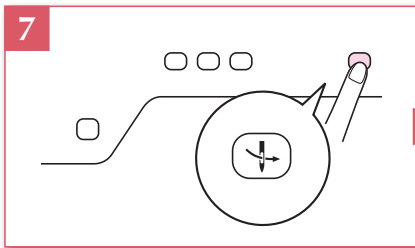
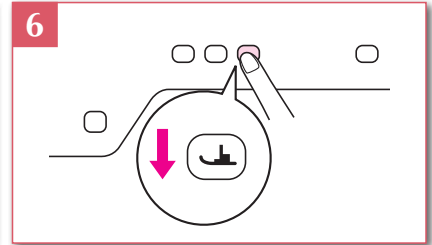
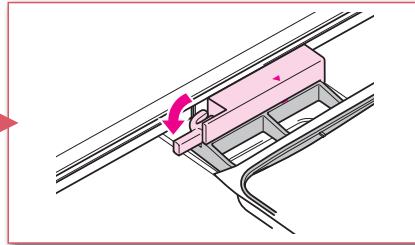
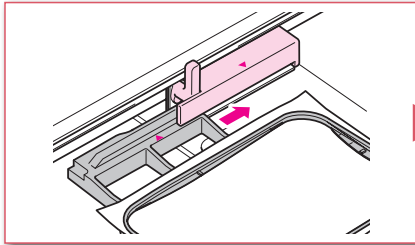

Selecting Embroidery Patterns

Seleccionar patrones de bordado

Sélection des motifs de broderie

❖ LCD Flow Chart

❖ Diagrama de flujo del LCD

❖ Organigramme de l'écran à cristaux liquides

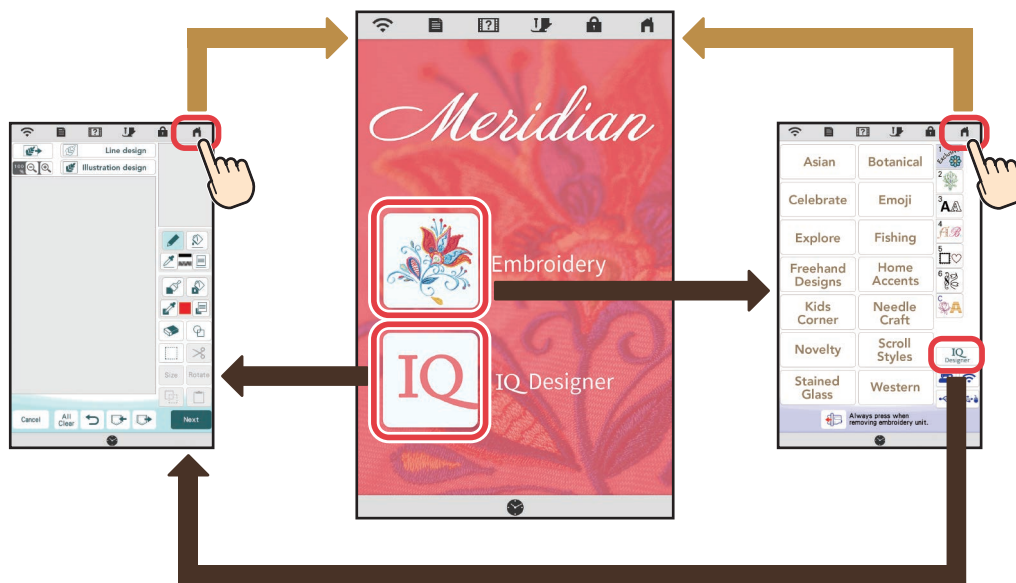

Embroidery Patterns

When the machine is turned on, the opening movie is played. Touch the screen to display the home screen. Touch  to display the Embroidery Screen.

Patrones de bordado

Cuando se activa la máquina, se reproduce el vídeo de presentación. Toque la pantalla para visualizar la pantalla inicial. Toque  para visualizar la pantalla de bordado.

Motifs de broderie

Quand la machine est mise sous tension, la vidéo de démarrage commence. Touchez l'écran pour afficher la page d'accueil. Touchez  pour afficher l'écran de broderie.

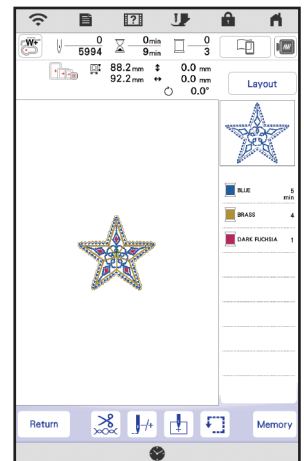
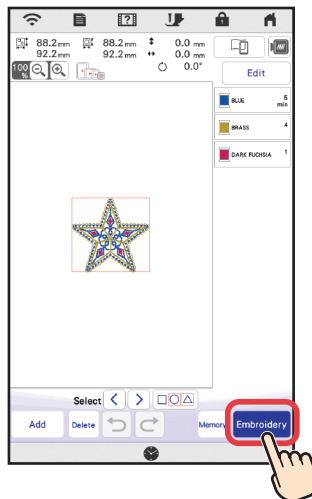
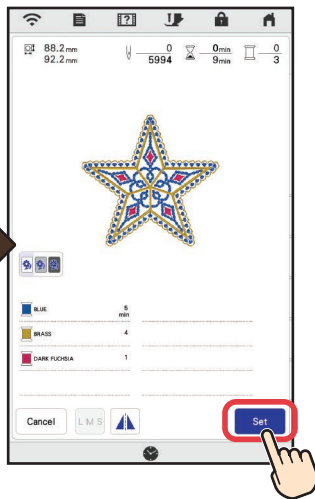
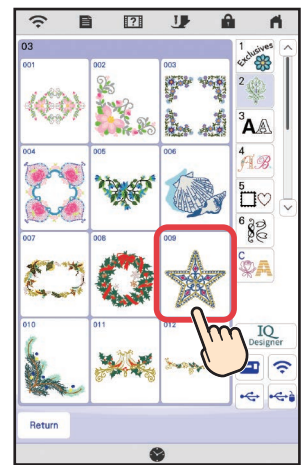
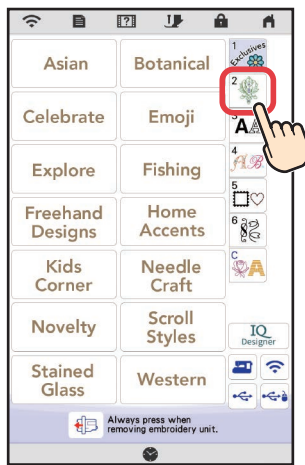



✿ Embroidery Patterns

✿ Patrones de bordado

✿ Motifs de broderie

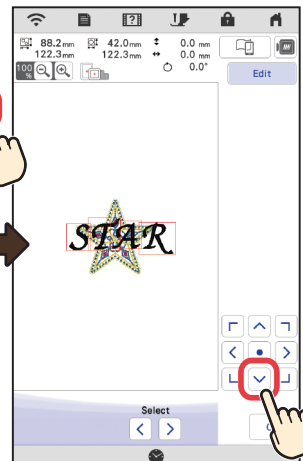
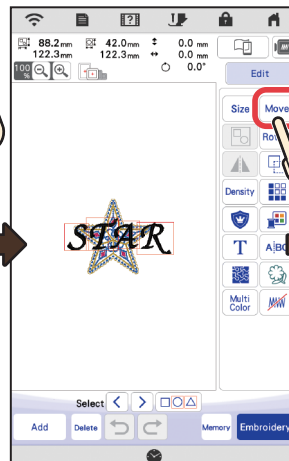
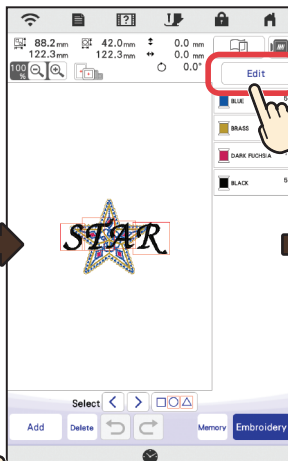
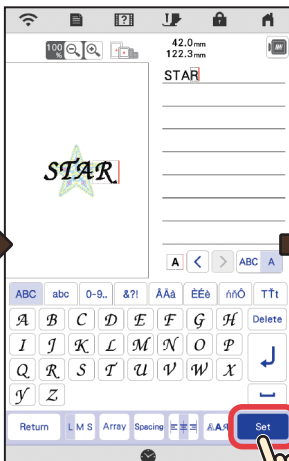
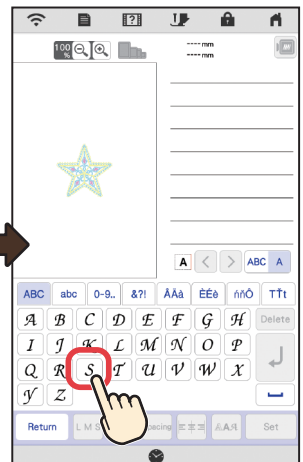
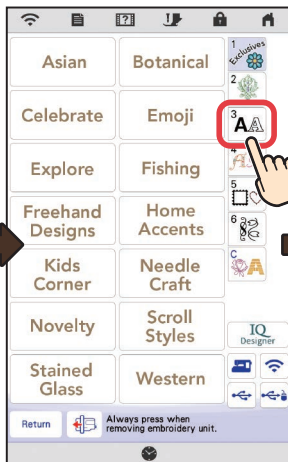
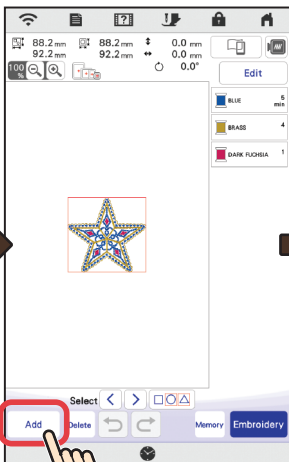
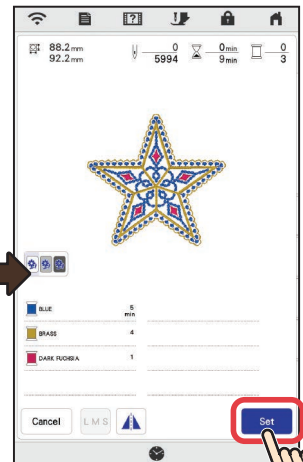
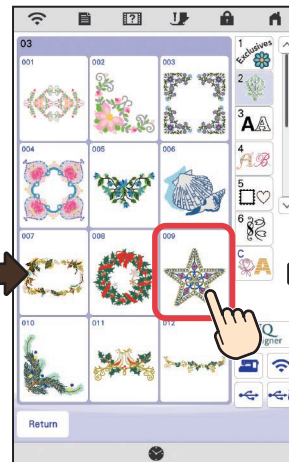
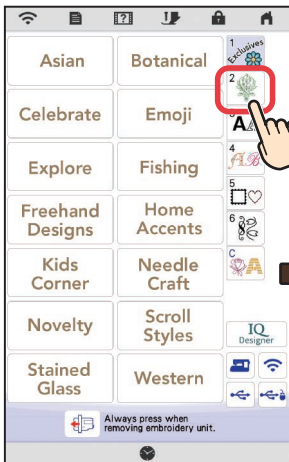

Selecting Embroidery Patterns
Seleccionar patrones de bordado
Sélection des motifs de broderie

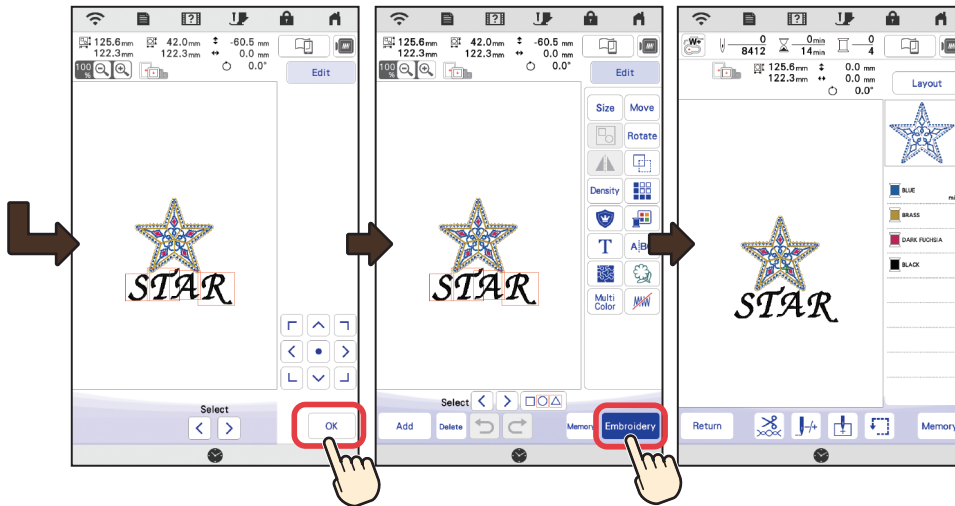







Meridian 2TM



FOR THE LOVE OF SEWING

English
Spanish
French
882-W84

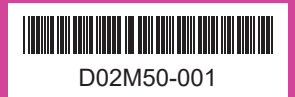

D02M50-001