

Solaris™

Quick Reference Guide Guide de référence rapide

Model BLSA



baby lock

FOR THE LOVE OF SEWING

To register your machine warranty and receive Baby Lock product updates and offers, go to babylock.com/login. If you have questions about registration, visit your Authorized Baby Lock Retailer.

Baby Lock Consumer Helpline: 800-313-4110

www.BabyLock.com

Contents

- 2 Winding the Bobbin
- 5 Setting the Bobbin
- 6 Upper Threading
- 8 Preparing to Embroider
- 10 Care and Maintenance
- 12 Cleaning the Race
- 13 Viewing PDF on machine

Contenido

- 2 Devanado de la bobina
- 5 Colocación de la bobina
- 6 Hilo superior
- 8 Preparativos para bordar
- 10 Cuidados y mantenimiento
- 12 Limpiar la guía
- 13 Ver el PDF en la máquina

Table des matières

- 2 Bobinage de la canette
- 5 Mise en place de la canette
- 6 Enfilage supérieur
- 8 Préparation de la broderie
- 10 Entretien et maintenance
- 12 Nettoyage de la coursière
- 13 Affichage du fichier PDF sur la machine

Winding the Bobbin

Devanado de la bobina

Bobinage de la canette

Follow the numbered steps below in order. Refer to the operation manual for detailed instruction.

Realice los siguientes pasos numerados en el orden indicado. Para obtener instrucciones detalladas, consulte el manual de instrucciones.

Suivez les étapes numérotées ci-dessous dans l'ordre. Consultez le manuel d'instructions pour des procédures détaillées.

Use only the enclosed bobbin or bobbins of the same type. Bobbin included with the machine is Class 15 type bobbin.

Utilice sólo la bobina incluida o bobinas del mismo tipo. La bobina incluida con la máquina es de Clase 15.

N'utilisez que la canette fournie ou des canettes du même type. La canette fournie avec la machine est de type Classe 15.

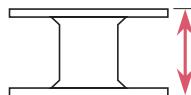

11.5 mm (approx. 7/16 inch)
11,5 mm (aprox. 7/16 pulg.)
11,5 mm (env. 7/16 po)

✂ Using the Supplemental Spool Pin

You can wind the bobbin during sewing.

✂ Uso del portacarrete suplementario

Puede devanar la bobina mientras está cosiendo.

✂ Utilisation du porte-bobine supplémentaire

Vous pouvez bobiner la canette pendant la couture.

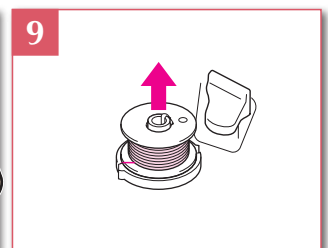
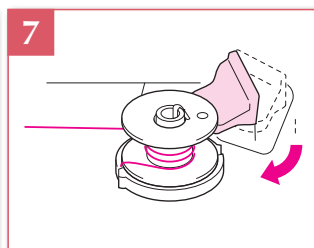
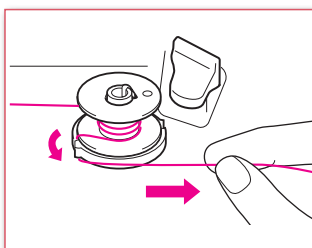
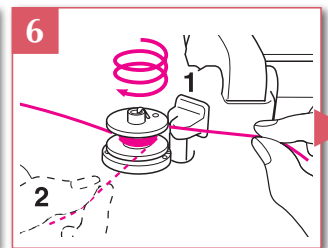
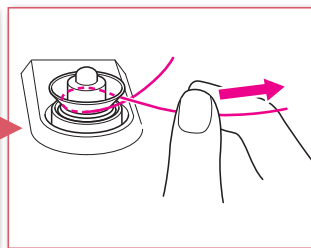
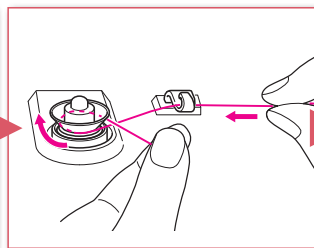
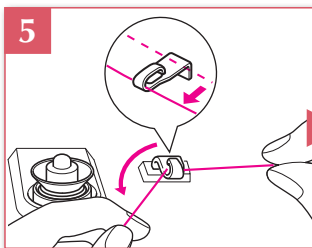
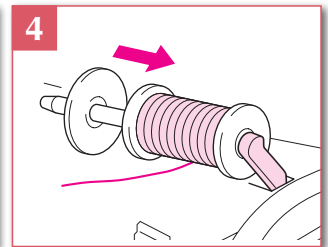
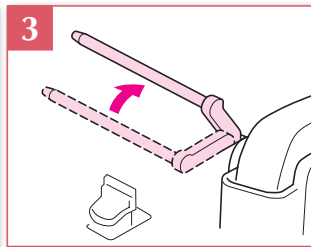
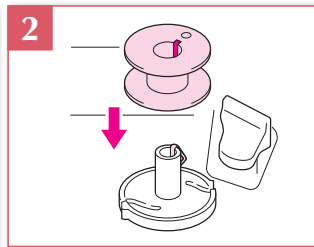
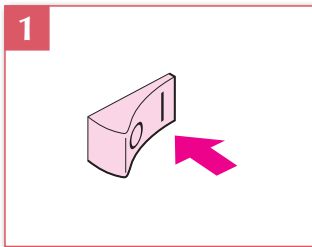
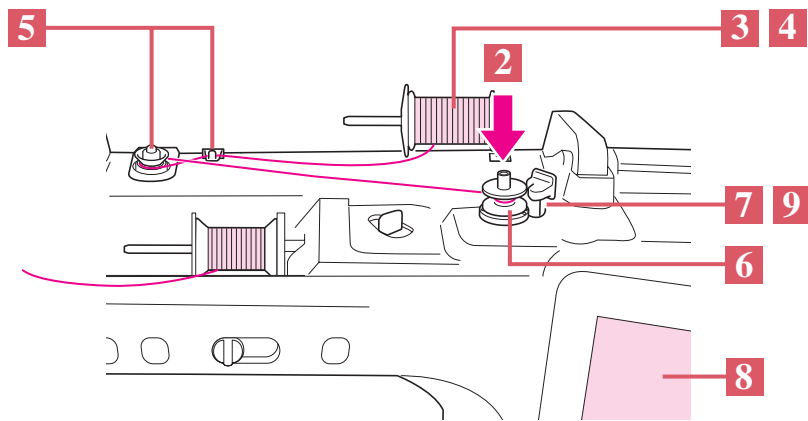

Winding the Bobbin Devanado de la bobina Bobinage de la canette

Using the Spool Pin

You can use the main spool pin to wind the bobbin before sewing.

Uso del portacarrete

Puede utilizar el portacarrete principal para devanar la bobina antes de coser.

Utilisation du porte-bobine

Vous pouvez bobiner la canette avant de coudre à l'aide du porte-bobine principal.

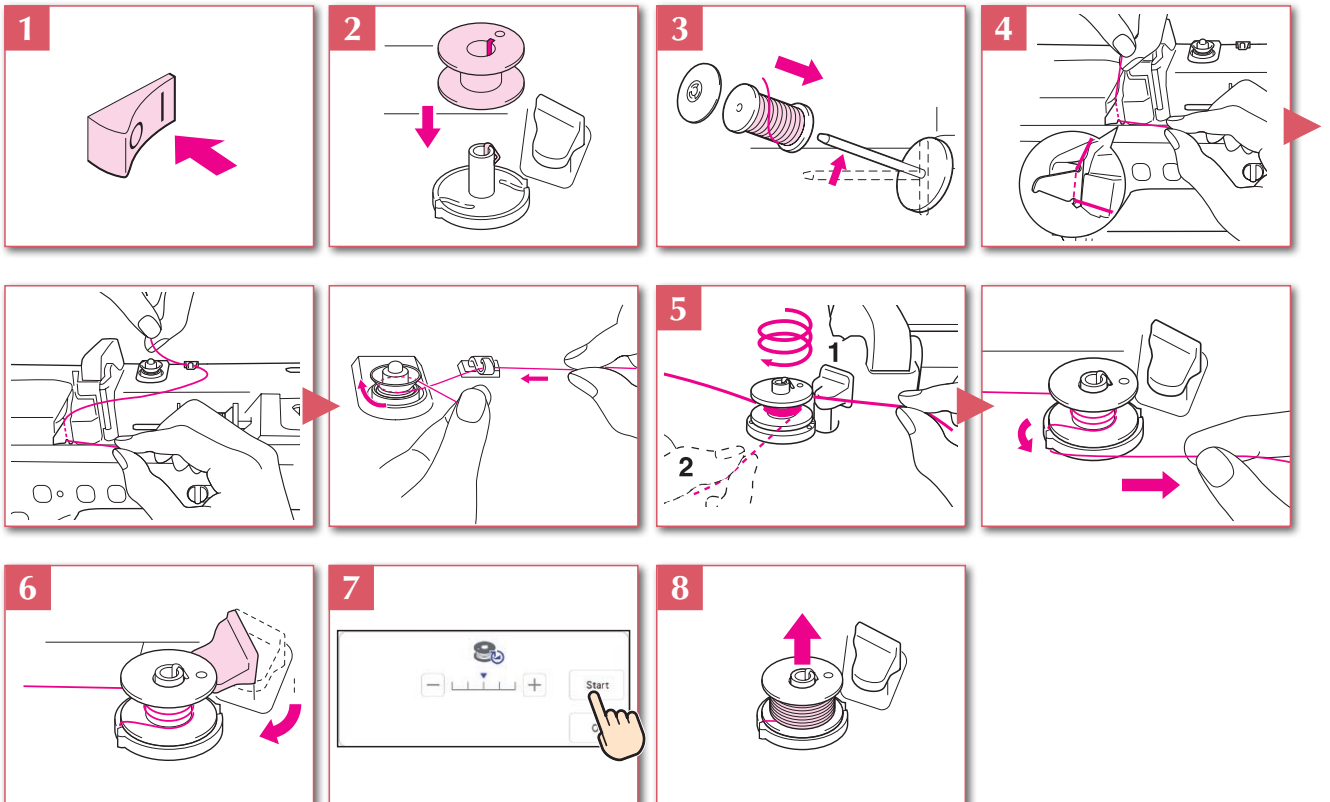
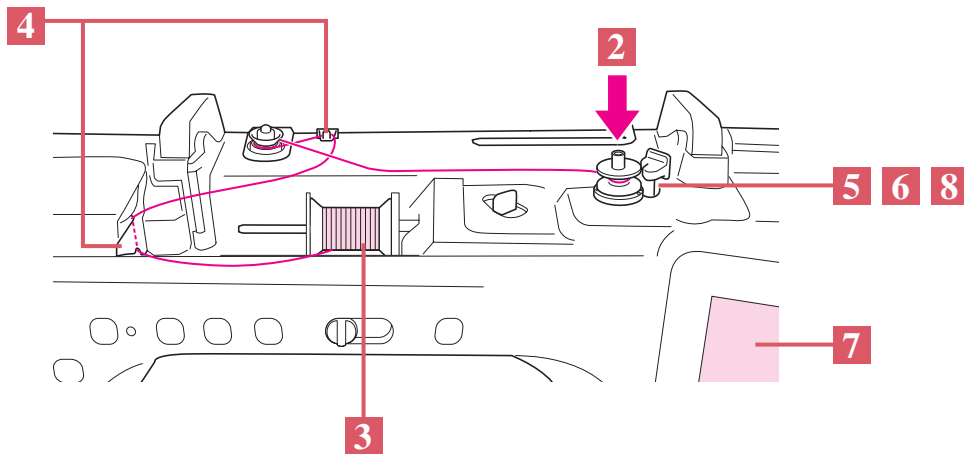

Setting the Bobbin

Colocación de la bobina

Mise en place de la canette

Refer to the operation manual for detailed instruction.

Consulte el manual de instrucciones para ver más detalles.

Pour les instructions détaillées, voir le mode d'emploi.

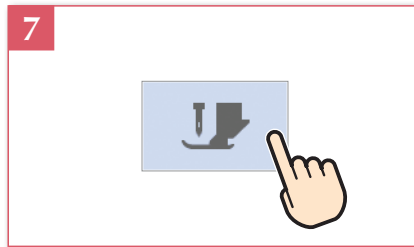
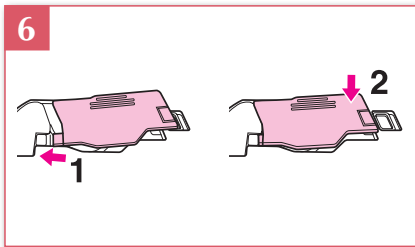
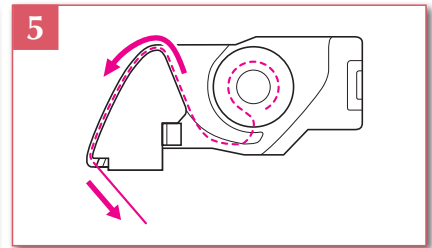
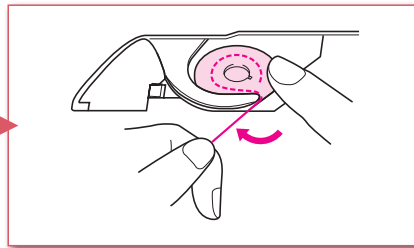
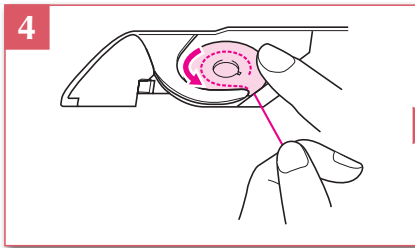
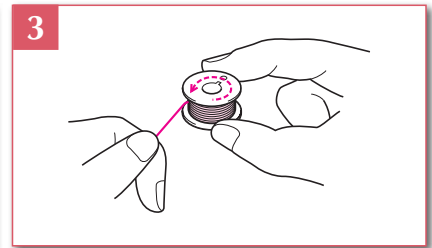
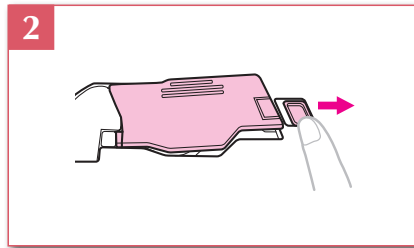
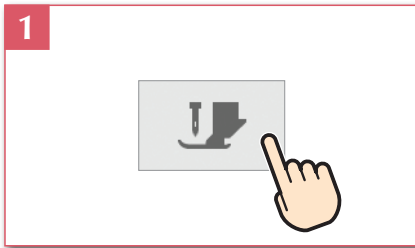

Upper Threading

Hilo superior

Enfilage supérieur

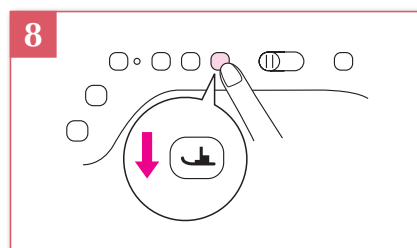
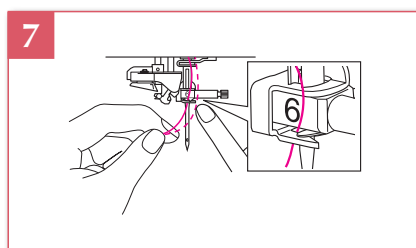
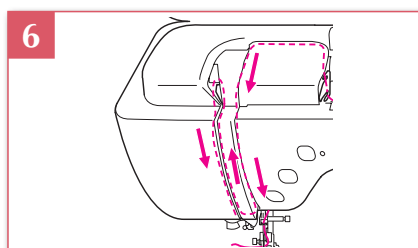
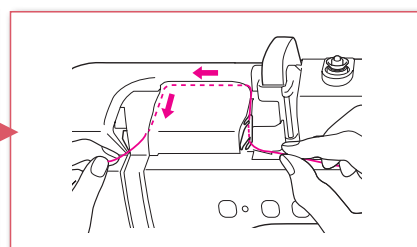
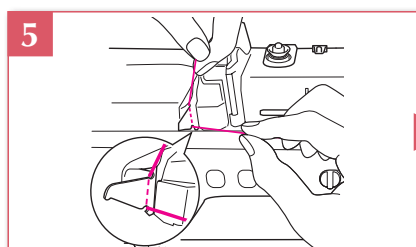
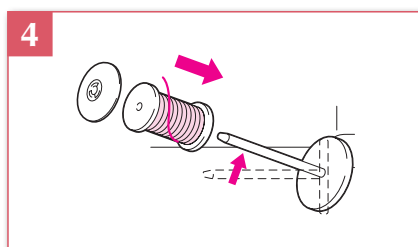
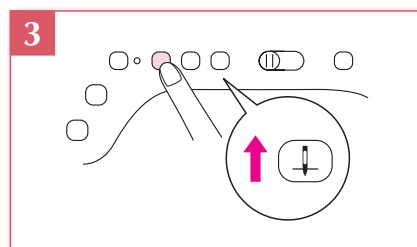
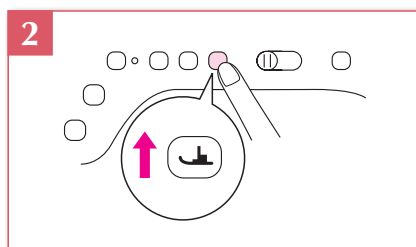
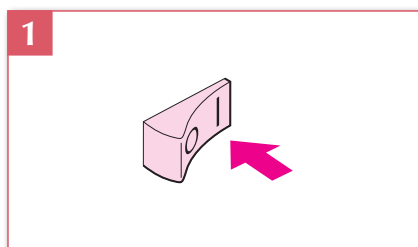
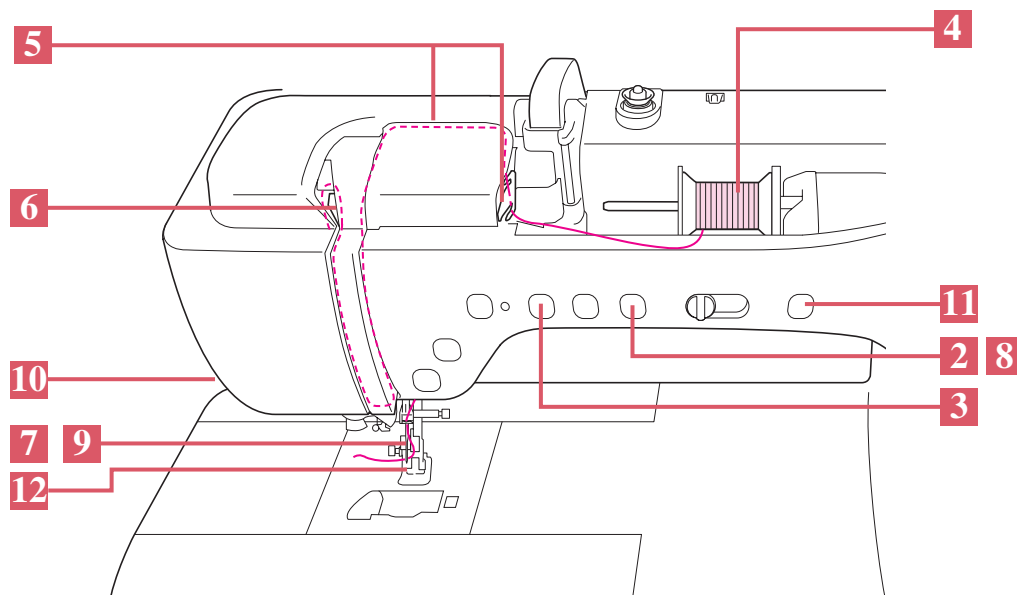

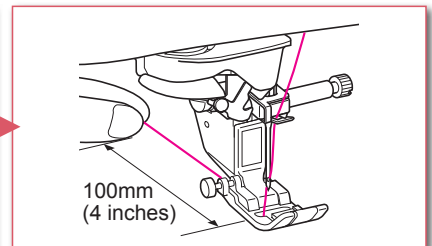
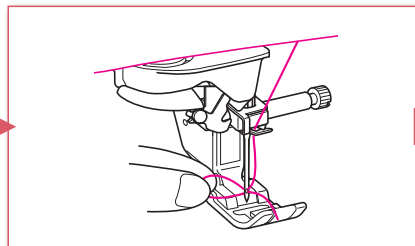
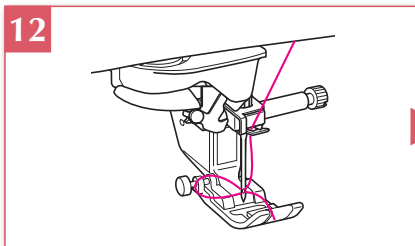
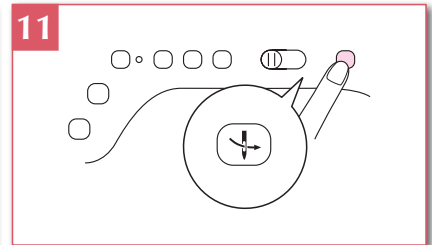
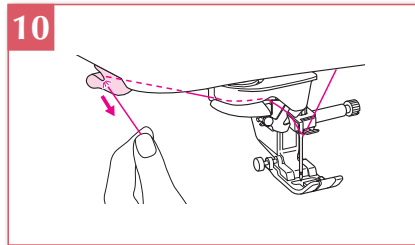
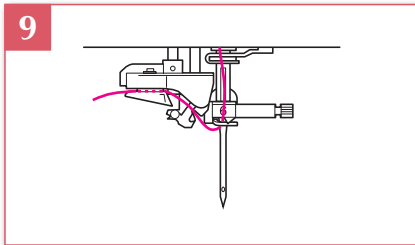

Preparing to Embroider

Preparativos para bordar

Préparation de la broderie

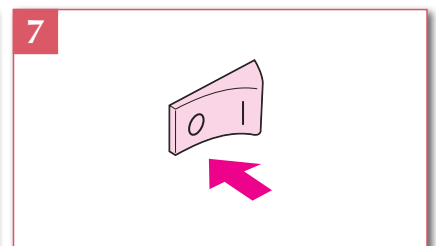
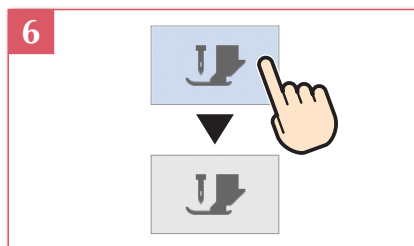
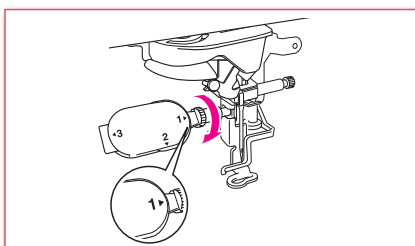
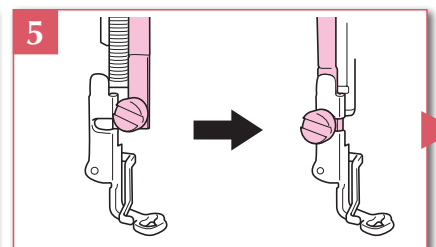
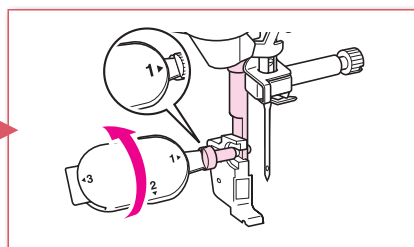
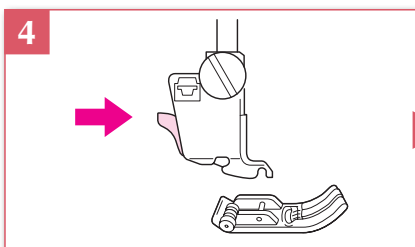
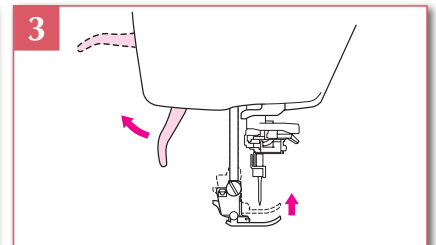
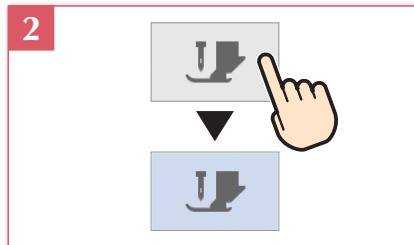
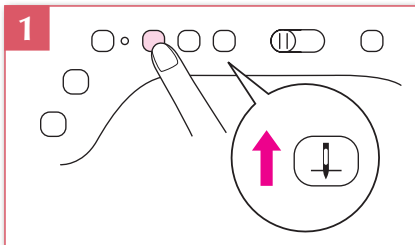
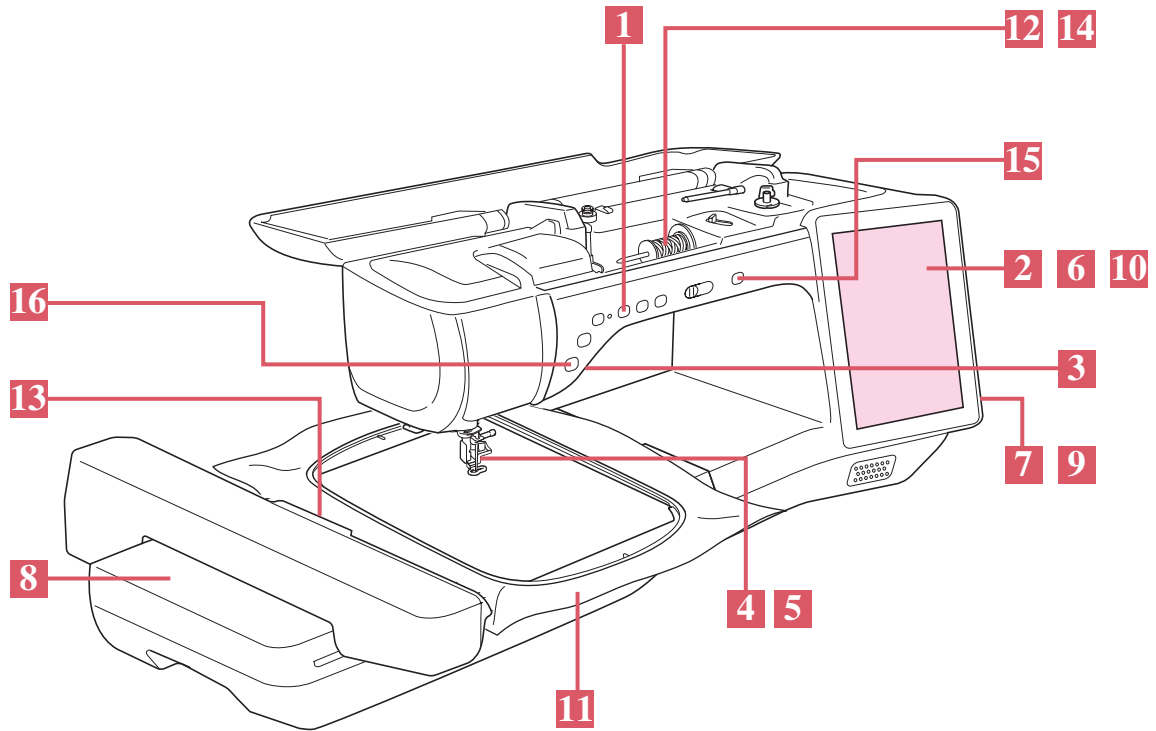

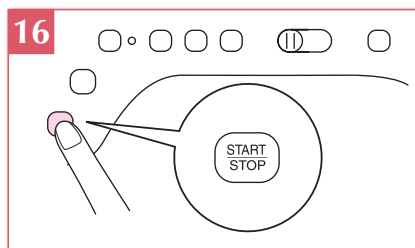
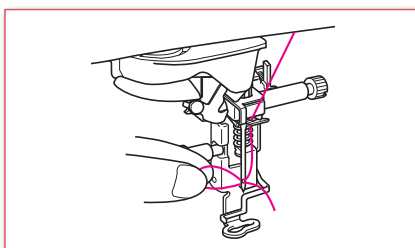
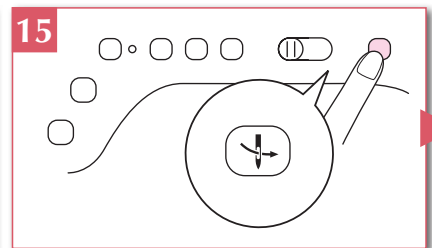
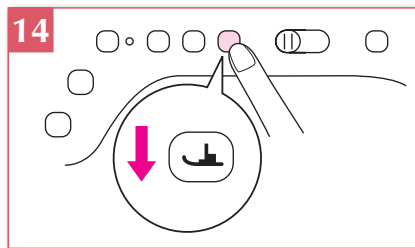
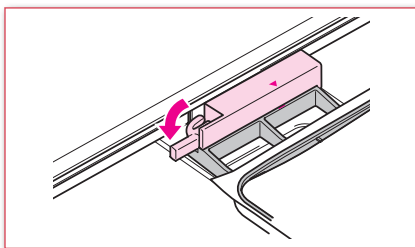
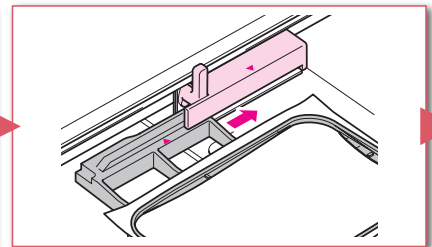
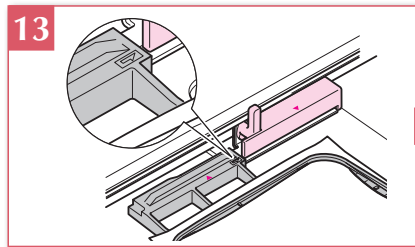
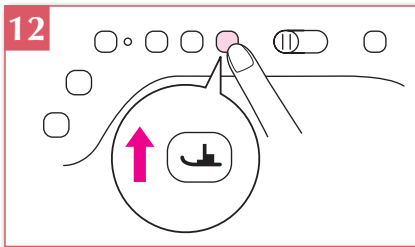
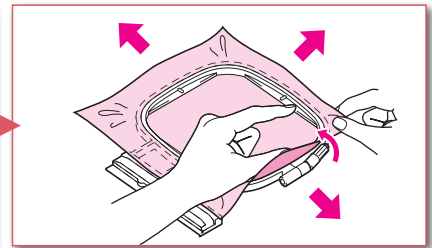
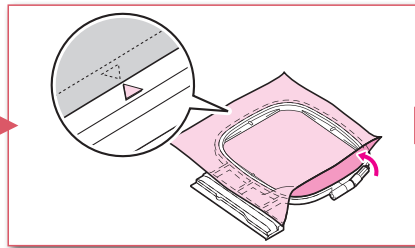
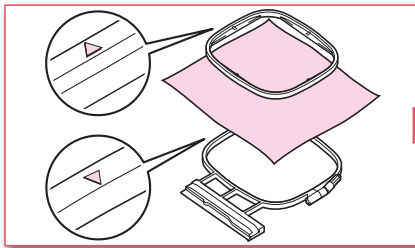
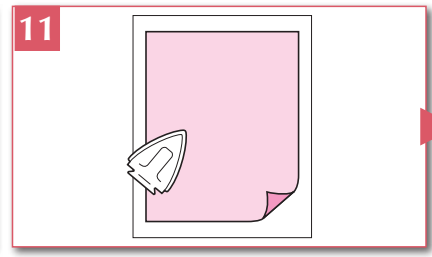
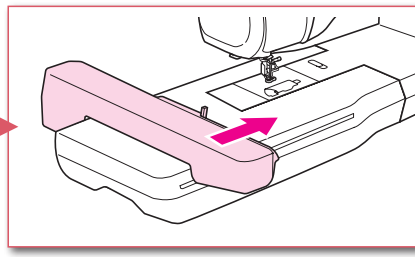
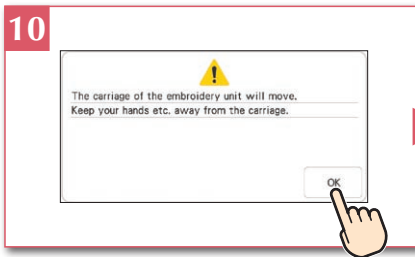
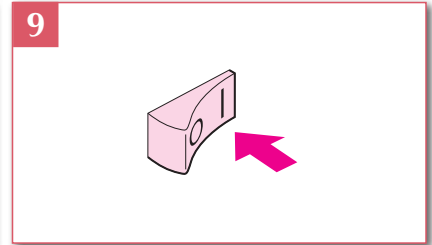
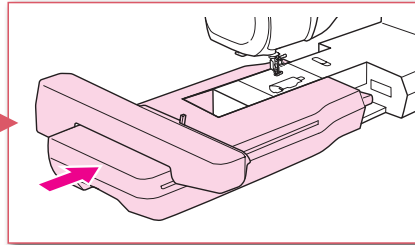
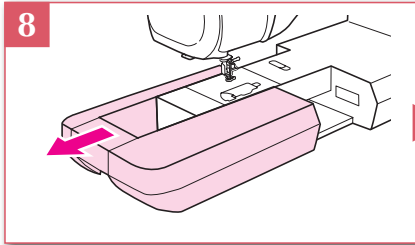

Care and Maintenance

Cuidados y mantenimiento

Entretien et maintenance

⚠ CAUTION

- Be sure to unplug the machine before cleaning it. Otherwise, electric shock or injury may result.

⚠ PRECAUCIÓN

- Asegúrese de desenchufar la máquina antes de limpiarla. De lo contrario, podría recibir una descarga eléctrica o hacerse daño.

⚠ ATTENTION

- Veillez à débrancher le cordon d'alimentation de la machine avant de la nettoyer. Sinon, vous risquez une décharge électrique ou de vous blesser.

✂ Restrictions on oiling

In order to prevent damaging this machine, it must not be oiled by the user. This machine was manufactured with the necessary amount of oil applied to ensure correct operation, making periodic oiling unnecessary.

If problems occur, such as difficulty turning the handwheel or an unusual noise, immediately stop using the machine, and contact your authorized Baby Lock retailer.

✂ Restricciones al lubricar la máquina

Para evitar que se averíe la máquina, no debe ser lubricada por el usuario. Esta máquina se ha fabricado con la cantidad necesaria de aceite lubricante ya aplicada para garantizar así un funcionamiento correcto, lo que hace que la lubricación periódica sea innecesaria. Si se producen problemas, como dificultades para girar la polea o ruidos anormales, deje de utilizar la máquina inmediatamente y póngase en contacto con su distribuidor Baby Lock autorizado.

✂ Restrictions en matière d'application d'huile

La machine doit être huilée pour éviter de l'endommager. Lors de la fabrication de cette machine, la quantité d'huile nécessaire a été appliquée afin de garantir un fonctionnement correct et éviter d'avoir à appliquer régulièrement de l'huile. En cas de problème, par exemple des difficultés à tourner le volant ou un bruit inhabituel, cessez immédiatement d'utiliser la machine et contactez votre revendeur Baby Lock.

✂ Precautions on storing the machine

Do not store the machine in any of the locations described below, otherwise damage to the machine may result, for example, rust caused by condensation.

- * Exposed to extremely high temperatures
- * Exposed to extremely low temperatures
- * Exposed to extreme temperature changes
- * Exposed to high humidity or steam
- * Near a flame, heater or air conditioner
- * Outdoors or exposed to direct sunlight
- * Exposed to extremely dusty or oily environments

✂ Medidas de precaución al almacenar la máquina

No almacene la máquina en ninguno de los lugares que se describen a continuación ya que, de lo contrario, la máquina podría averiarse; por ejemplo, óxido causado por la condensación.

- * Expuesta a temperaturas extremadamente altas
- * Expuesta a temperaturas extremadamente bajas
- * Expuesta a cambios de temperatura extremos
- * Expuesta a humedad elevada o vapor
- * Cerca de una llama, calefactor o aparato de aire acondicionado
- * En el exterior o expuesta a la luz solar directa
- * Expuesta a entornos con mucho polvo o grasa

✂ Précautions concernant le rangement de la machine

Ne rangez pas la machine dans l'un des endroits indiqués ci-dessous, car cela risquerait de l'endommager (par exemple, apparition de rouille suite à de la condensation).

- * Exposition à des températures très élevées
- * Exposition à des températures très basses
- * Exposition à de fortes variations de température
- * Exposition à une forte humidité ou beaucoup de vapeur
- * Rangement à proximité d'une flamme, d'un chauffage ou d'un climatiseur
- * Rangement à l'extérieur ou exposition aux rayons directs du soleil
- * Exposition à des environnements très poussiéreux ou huileux

💡 Note

- In order to extend the life of this machine, periodically turn it on and use it. Storing this machine for an extended period of time without using it may reduce its efficiency.

💡 Nota

- Para prolongar la vida útil de esta máquina, enciéndala periódicamente y utilícela. Si almacena esta máquina durante un período de tiempo prolongado sin utilizarla, su eficacia puede verse reducida.

💡 Remarque

- Pour prolonger la durée de vie de la machine, mettez-la sous tension et utilisez-la régulièrement. Le rangement de la machine pendant une durée prolongée sans l'utiliser risque de diminuer son efficacité.

✂ Cleaning the LCD Screen

If the screen is dirty, gently wipe it with the included LCD cleaning cloth or a soft, dry cloth. Do not use organic solvents or detergents.

✂ Limpieza de la pantalla LCD

Si la pantalla está sucia, límpiela suavemente con el paño de limpieza de pantallas LCD incluido o con un paño suave y seco. No use disolventes orgánicos ni detergentes.

✂ Nettoyage de l'écran à cristaux liquides

Si l'écran est sale, nettoyez-le doucement avec le tissu de nettoyage pour écran inclus ou un chiffon doux et sec. N'utilisez pas de solvants organiques ou des détergents.

💡 Note

- Do not wipe the LCD screen with a damp cloth.

💡 Nota

- No frote la pantalla LCD con un paño húmedo.

💡 Remarque

- Ne passez pas de chiffon humide sur l'écran à cristaux liquides.



Memo

- Occasionally, condensation may form on the LCD screen or it may become fogged up; however, this is not a malfunction. After a while, the cloudiness will disappear.



Recuerde

- Ocasionalmente, puede formarse condensación en la pantalla LCD o puede empañarse; sin embargo, esto no es una avería. Transcurridos unos instantes, el empañamiento desaparecerá.



Mémo

- Il peut arriver que de la condensation se forme sur l'écran à cristaux liquides, ou qu'il s'embue. Ceci n'est pas signe de dysfonctionnement. La buée se dissipe au bout d'un moment.

❖ Cleaning the Machine Casing

If the surface of the machine is dirty, lightly soak a cloth in a neutral detergent, squeeze it out firmly, and then wipe the surface. Then wipe again with a dry cloth.

❖ Limpieza de la carcasa de la máquina

Si la superficie de la máquina está sucia, límpiela con un paño humedecido con un detergente neutro, escúrralo bien y páselo por la superficie. Después seque con un paño seco.

❖ Nettoyage du capot de la machine

Si l'extérieur de la machine est sale, humidifiez légèrement un chiffon avec un détergent neutre, tordez-le bien, puis essuyez la surface externe. Ensuite, essuyez-la de nouveau avec un chiffon sec.

❖ TROUBLESHOOTING

❖ SOLUCIÓN DE PROBLEMAS

❖ DÉPANNAGE

Problem	Cause	Solution
Machine does not operate	All keys and buttons have been locked by	Press to unlock all keys and buttons.
Nothing appears in the LCD.	Main power switch is not turned on.	Turn the main power to ON.
	The plug of the power cord is not inserted into an electrical outlet.	Insert the plug of the power cord into an electrical outlet.
Nothing happens, even if the LCD display is pressed	The screen has been locked.	Press either of the following keys to unlock the screen.

Problema	Causa	Solución
La máquina no funciona.	Todas las teclas y los botones están bloqueados por	Pulse para desbloquear todas las teclas y botones
No se ve nada en la pantalla LCD.	El interruptor de alimentación no está en la posición de encendido.	Encienda la máquina de coser.
	El enchufe del cable de alimentación no está conectado a una toma de corriente.	Conecte el enchufe del cable de alimentación a una toma de corriente.
No ocurre nada incluso si se pulsa la pantalla LCD	La pantalla se ha bloqueado.	Pulse una de las teclas siguientes para desbloquear la pantalla.

Problème	Cause	Solution
La machine ne fonctionne pas	Toutes les touches et tous les boutons ont été verrouillés par le biais de	Appuyez pour déverrouiller toutes les touches et tous les boutons
Aucune information ne s'affiche sur l'écran à cristaux liquides.	La machine n'est pas sous tension.	Mettez la machine sous tension.
	La fiche du cordon d'alimentation n'est pas insérée dans une prise électrique.	Insérez la fiche du cordon d'alimentation dans une prise électrique.
Rien ne se passe, même si vous appuyez sur l'écran à cristaux liquides	L'écran a été verrouillé.	Appuyez sur l'une des touches suivantes pour déverrouiller l'écran.

Cleaning the Race

Limpiar la guía

Nettoyage de la coursière

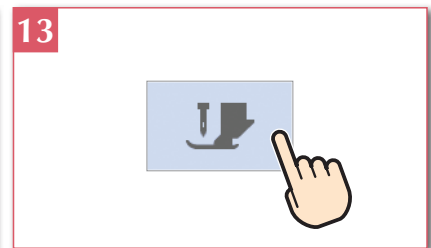
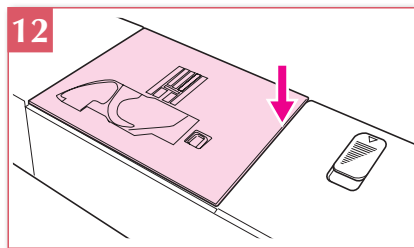
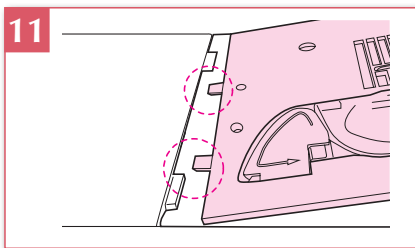
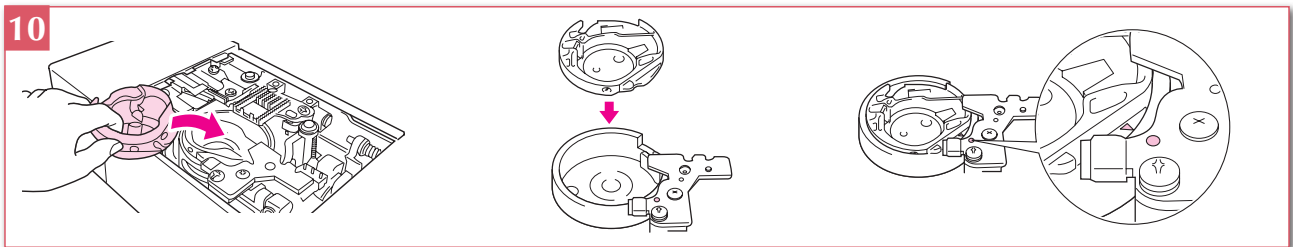
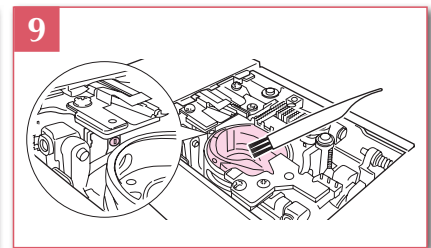
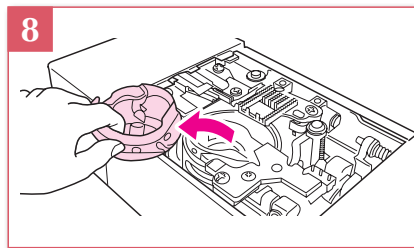
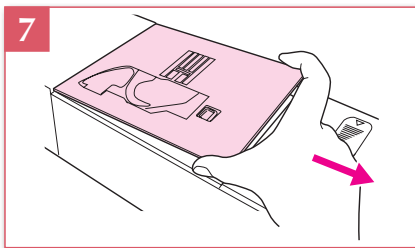
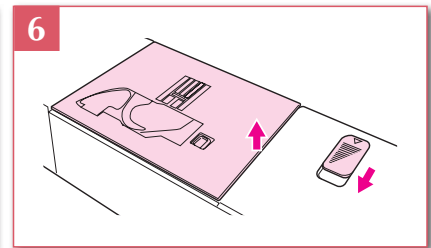
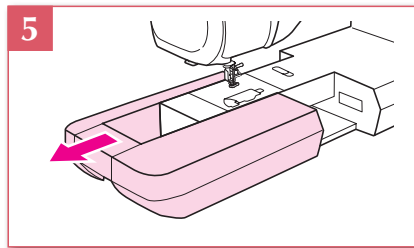
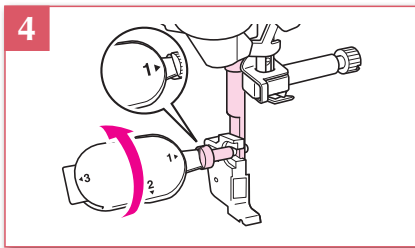
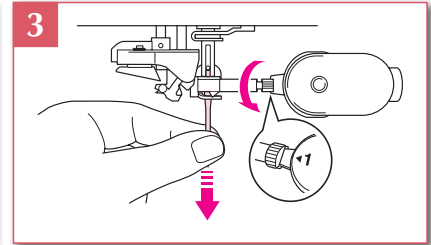
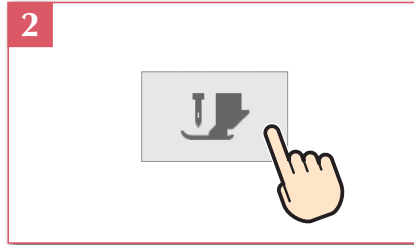
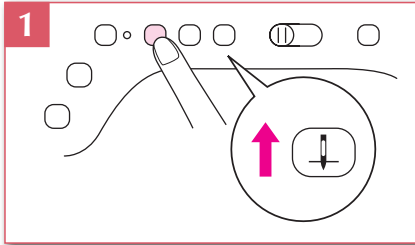

Viewing PDF on machine

Ver el PDF en la máquina

Affichage du fichier PDF sur la machine

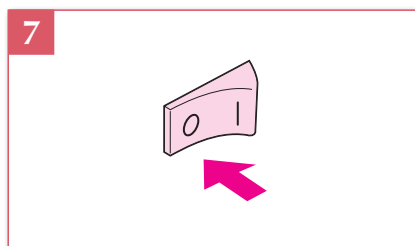
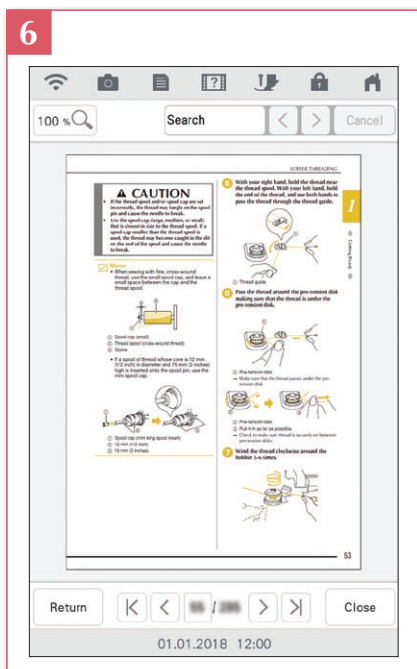
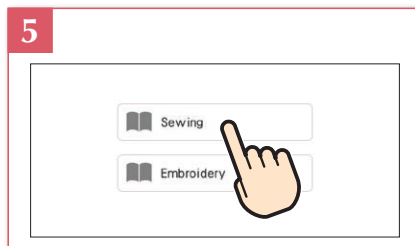
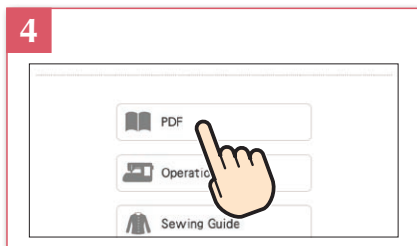
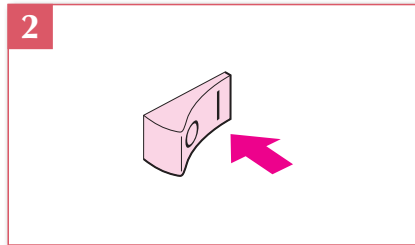
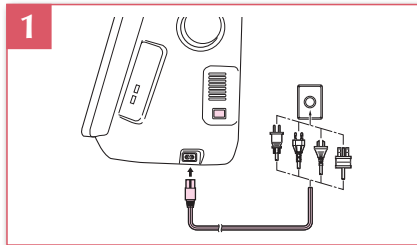

*Solaris*TM



FOR THE LOVE OF SEWING

English
Spanish
French

882-W31



XH2697-001