

Tiara BABY LOCK *III*

Instruction and Reference Guide

Model BLTR16-3



FOR THE LOVE OF SEWING

To register your machine warranty and receive Baby Lock product updates and offers, go to babylock.com/profile. If you have questions with registration, visit your Authorized Baby Lock Retailer.

Baby Lock Consumer Helpline: 800-313-4110

www.babylock.com

Table of Contents

Congratulations on Your Baby Lock Tiara III Purchase.....	2
Baby Lock Tiara III Important Information.....	3
Regulations.....	3
Important Safety Instructions.....	4
How to Pack/Unpack Machine.....	5
Instructions Before Using Machine.....	5
Optional U.S. Grounding.....	6
About Your Machine: Quick Facts.....	7
Package Contents/Included Accessories.....	8
Optional Accessories.....	9
Baby Lock Tiara III Components.....	10
Front Side View.....	10
Back Side View.....	11
Rear and Front Views.....	12
Installation and Setup.....	13
Setting Up the Table (and Taking Down for Storage).....	13
Placing Machine in Table.....	13
Installing the Power Cord.....	14
Installing the Foot Pedal.....	14
Installing Thread Antennae.....	14
Installing Color Touch-Screen Display.....	15
Inserting or Changing Needle.....	15
Needle/Thread Selection Guide.....	16
Changing Hopping Foot.....	17
Threading the Machine.....	18
Bobbin Case and Bobbin Thread Tension Adjustments.....	20
Top Thread Tension Adjustment.....	22
Maintenance.....	23
Using the Touch-Screen Displays.....	25
Preparing to Quilt.....	35
Troubleshooting.....	36

Congratulations on your purchase of the Baby Lock Tiara III

You haven't just purchased a quilting machine, you've joined the Baby Lock family and we welcome you.

Baby Lock is committed to innovation, reliability, customer service and education. Our quilting machines are designed for quilters and we are committed to your quilting success.

With that in mind, we invite you to bookmark our website: www.babylock.com and invite you to visit to learn more about the art of quilting.

Remember, if you ever have questions, your authorized Baby Lock retailer can help you. If your retailer is not available, contact Baby Lock directly by visiting our website, www.babylock.com or contacting our Baby Lock Consumer Helpline at 1-800-313-4110, Monday through Friday, 8 AM to 6 PM CST.

Important Information: Regulations

Federal Communications Commissions (FCC) Declaration of Conformity (For USA Only)

Responsible Party: Tacony Corporation
1760 Gilsinn Lane
Fenton, MO 63026

declares that the product

Product Name: Baby Lock Tiara III Model BLTR16-3

complies with Part 15 of the FCC Rules. Operation is subject to the following two conditions: (1) this device may not cause harmful interference, and (2) this device must accept any interference received, including interference that may cause undesired operation.

This equipment has been tested and found to comply with the limits for Class B digital device, pursuant to Part 15 of the FCC Rules. These limits are designed to provide reasonable protection against harmful interference in a residential installation. This equipment generates, uses, and can radiate radio frequency energy and, if not installed and used in accordance with the instructions, may cause harmful interference to radio communications. However, there is no guarantee that interference will not occur in a particular installation. If this equipment does cause harmful interference to radio or television reception, which can be determined by turning the equipment off and on, the user is encouraged to try to correct the interference by one or more of the following measures:

- Reorient or relocate the receiving antenna.
- Increase the separation between the equipment and receiver.
- Consult the retailer or an experienced radio/TV technician for help.
- Changes or modifications not expressly approved by the manufacturer or local sales distributor could void the user's authority to operate the equipment.

Canadian Department of Communications Compliance Statement (For Canada Only)

This digital apparatus does not exceed the Class B limits for radio noise emission from digital apparatus as set out in the interference-causing equipment standard entitled "Digital Apparatus", ICES-003 of the Department of Communications.

Radio Interference (Other than USA and Canada)

This machine complies with EN55022 (CISPR Publication 22) /Class B and AUS/NZ 55022/Class B.

Important Safety Instructions

This device complies with Part 15 of the FCC Rules. Operation is subject to the following two conditions: (1) This device may not cause harmful interference, and (2) this device must accept any interference received, including interference that may cause undesired operation.

Please note: Do not operate your Baby Lock Tiara III quilting machine until you have completely read the information contained in this manual. Please keep all packaging and order information for warranty purposes.

Read all instructions before using.

When using this machine, basic safety precautions should always be taken, including the following.

DANGER - To reduce the risk of electric shock:

- A quilting machine should never be left unattended when plugged in. Always unplug the machine from the electrical outlet immediately after using and before cleaning.

WARNING - To reduce the risk of burns, fire, electric shock, or injury to persons:

- The Baby Lock Tiara III is heavy. Never attempt to lift it alone. Always use two people when lifting. Always lift from the throat of the machine.
- Always unplug the Baby Lock Tiara III from the electrical outlet when performing any maintenance, changing the needle, removing thread locks, or when left unattended.
- Do not unplug by pulling on cord. To unplug, grasp the plug, not the cord.
- Keep fingers away from all moving parts. Use caution around the needle or sharp external components.
- Change the needle often. Do not use bent or dull needles. "Every quilt deserves a new needle".
- Switch the machine to the symbol off, or 0, position to turn it off when making any adjustments in the needle area, such as threading needle, changing needle, threading bobbin, changing hopping foot, and so forth.
- Never drop or insert foreign objects into any opening.
- The Baby Lock Tiara III should only be used indoors away from moisture.
- The Baby Lock Tiara III should not be stored or used in extreme temperatures.
- Use the Baby Lock Tiara III only for its intended use as described in this manual.
- To disconnect from the wall outlet, push the switch to the off position, then remove the plug from outlet pulling from the plug, not the cord. Never operate the Baby Lock Tiara III if the cord is damaged or not working correctly. Return the Baby Lock Tiara III to the nearest Baby Lock retailer for examination, repair, electrical, or mechanical adjustment.
- It is not recommended that the Baby Lock Tiara III quilting machine be used with any machine quilting frame other than those recommended by Baby Lock.
- Use this quilting machine only for its intended use as described in this manual. Use only attachments recommended by the manufacturer as contained in this manual.
- Never operate the machine with any air openings blocked. Keep ventilation openings of the machine free from the accumulation of lint, dust, and loose cloth.
- Do not operate where aerosol (spray) products are being used or where oxygen is being administered.
- Do not pull or push the fabric excessively while stitching. It may deflect the needle enough to cause it to break.

- Use only needles designed for free motion quilting and recommended by Baby Lock for this machine. Other types of needles may break during normal quilting.
- Children shall not play with the machine. Close attention is necessary when this machine is used by or near children.
- This sewing machine may be used by children age 8 years and above and persons with reduced physical, sensory, or mental capabilities or lack of experience and knowledge if they have been given supervision or instruction concerning use of the machine in a safe way and understand the hazards involved.
- Cleaning and user maintenance shall not be made by children without supervision.

Save These Instructions

This machine is intended for household or commercial use.

Disclaimer

Baby Lock and its authorized retailers are in no way legally responsible or liable for damage to the Baby Lock Tiara III when used improperly or not in accordance with the guidelines stated in this manual or when used on machine quilting tables not recommended by Baby Lock.

How to Unpack/Repack the Machine

Keep the carton and packing materials. You will need them in the event that you need to return the machine to your authorized Baby Lock retailer or send it for repair. If you do not pack the machine properly or if you do not use the correct packaging materials, the machine could be damaged. Baby Lock is not liable for damage that occurs during return shipping. Follow the diagram below to unpack and repack the machine.

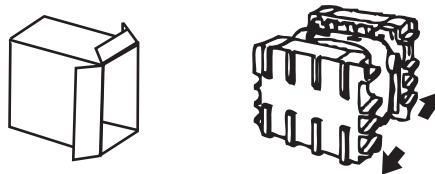

IMPORTANT

These packaging materials are designed to prevent the machine from being damaged. Keep them in case you need to bring this machine to your authorized Baby Lock retailer or send it for repair.

PLEASE READ THESE INSTRUCTIONS BEFORE USING THE MACHINE.

To use the machine safely

1. Carefully watch the needle while sewing. Do not touch the handwheel, take up lever, needle or other moving parts.
2. Turn the machine off and unplug the cord in the following cases
 - when you have stopped using the machine;
 - when you replace or remove the needle or any other part;
 - in case of failure when you use the machine;
 - when you check or clean the machine;
 - when you leave the machine unattended.

3. Connect the machine directly to the wall outlet. Do not use extension cords.

To increase the life of your machine

1. Do not store this machine in areas exposed to direct sunlight or high humidity. Never use or store the machine near a heater, an iron, a halogen lamp or other hot objects.
2. Use only neutral soaps or detergents to clean the machine. Benzene, solvents and scouring powders can damage the case and the machine and therefore should never be used.
3. Do not drop or bump the machine.
4. Always consult the manual to replace or fix the hopping foot, needle or any other part of the machine.

To repair or adjust the machine

If the machine malfunctions or requires adjustment, first check the troubleshooting chart in the appendix to inspect and adjust the machine yourself.

For more product information and updates, visit our website at www.babylock.com.

The contents of this manual and product specifications are subject to change without prior notice.

Optional U.S. Grounding

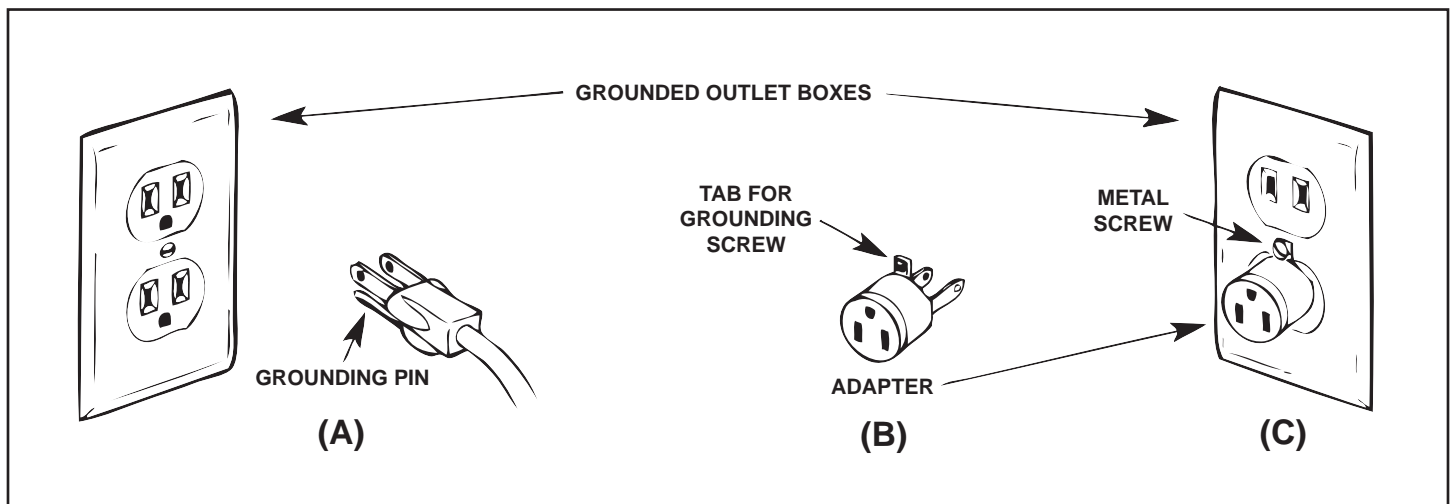

Figure 1

This product is for use on a nominal 120 V or nominal 220 V circuit, and has a grounding plug that looks like the plug illustrated in sketch A in Figure 1. A temporary adapter, which looks like the adapter illustrated in sketches B and C, may be used to connect this plug to a 2-pole receptacle as shown in sketch C if a properly grounded outlet is not available. The temporary adapter should be used only until a properly grounded outlet can be installed by a qualified electrician. The green colored rigid ear, lug, and the like, extending from the adapter must be connected to a permanent ground such as a properly grounded outlet box cover. Whenever the adapter is used, it must be held in place by the metal screw.

Note: In Canada, the use of a temporary adapter is not permitted by the Canadian Electric Code.

About Your Machine

Quick Facts

The Baby Lock Tiara III utilizes high-tech electronics and an innovative touch screen to offer greater functionality and ease of operation to home quilters than ever before conceived in the quilting industry. The Baby Lock Tiara III quilting machine is a high quality machine that incorporates very robust design features and is very easy to service.

Throat Dimensions	8.25" X 16" (245mm X 610mm)
Quilting Speed: Maximum	1800 SPM
Needle System	134 (135 X 7)
Needle Sizes	12/80 to 20/125
Hook System	Rotary, Horizontal axis, M-class bobbin
Bobbin Type	Aluminum, Class M
Bobbin Case	Type MF
Motor Type	Brushless DC
Needle Positioning	Up and down, tie-off stitch
Electrical Power	
US/Canada*	105 - 120 VAC, 47 - 63HZ, 300W peak
Rest of world	100 - 250 VAC, 47 - 63HZ, 300W peak
* Complies with international certifications	
LED Power Consumption	2.25W
Hopping Foot Stroke/Lift	5mm
Needle Bar Stroke	35.3mm
Take-Up Stroke	73mm
Lubrication, main components	Kluber Lube, permanent
Lubrication of hook	Velocite 10, Texaco 22

Disclaimer

Baby Lock and its authorized retailers are in no way legally responsible or liable for damage to the Baby Lock Tiara III when used improperly or not in accordance with the guidelines stated in this manual or when used on home machine quilting tables not recommended by Baby Lock.

Package Contents/Included Accessories

Part Name	Part Code
Machine Box	
Baby Lock Tiara III Quilting Machine	BLTR16A3
Instruction Manual	IBLTR16-3
Class M Bobbins (5 pieces)	BLJ-BOB (3 pkg.)
Needle size 16 (1 pkg. of 10)	134FG-100
Needle size 18 (1 pkg. of 10)	134FG-110
Bobbin Case	JW000586
Thread Antenna	JW010214
Oiler	JW010272
Power Cord	JW020277
Brush	JW010270
Disc-shaped Screwdriver	XC1074051
Screwdriver (bobbin case)	JW010269
2.5mm Allen Wrench	QM10286
3.0mm Allen Wrench	JW010287
5.0mm Allen Wrench	JW010289
8mm Open Wrench	QM40235
Open-Toe Hopping Foot	QM10510



Bobbin Winder Box	
Variable-Speed Bobbin Winder	BLQBW

Table Box	
Tiara III Quilting Table	BLTRT16



Optional Accessories *(available from your authorized Baby Lock retailer)*

Tiara III 18" Quilting Table Extension (BLTRT16-E)

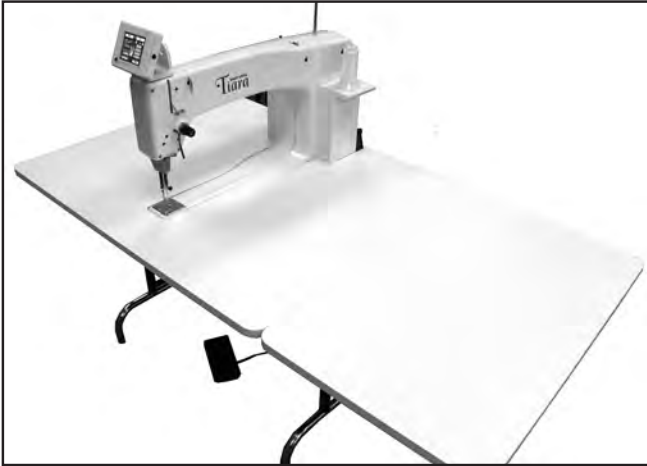

Tiara III Quilting Table Overlay (BLTRT16-O)

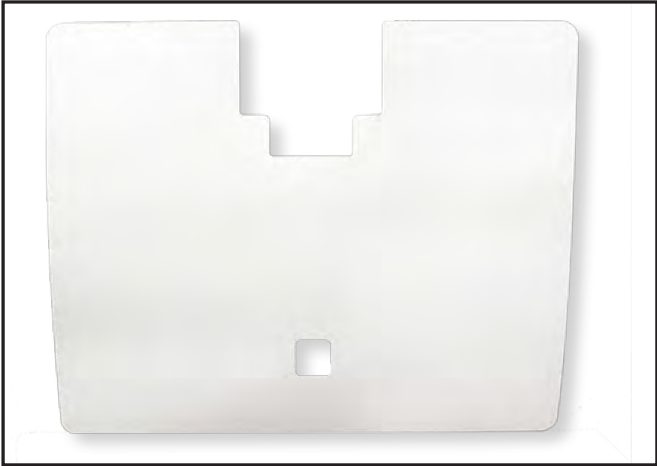

Horizontal Spool Pin (BLJ18-HS)



TruStitch Stitch Regulator for Tiara III (BLTRTS)



Couching Feet Set (BLQ-CCF)



Baby Lock Tiara III Components

Front Side View

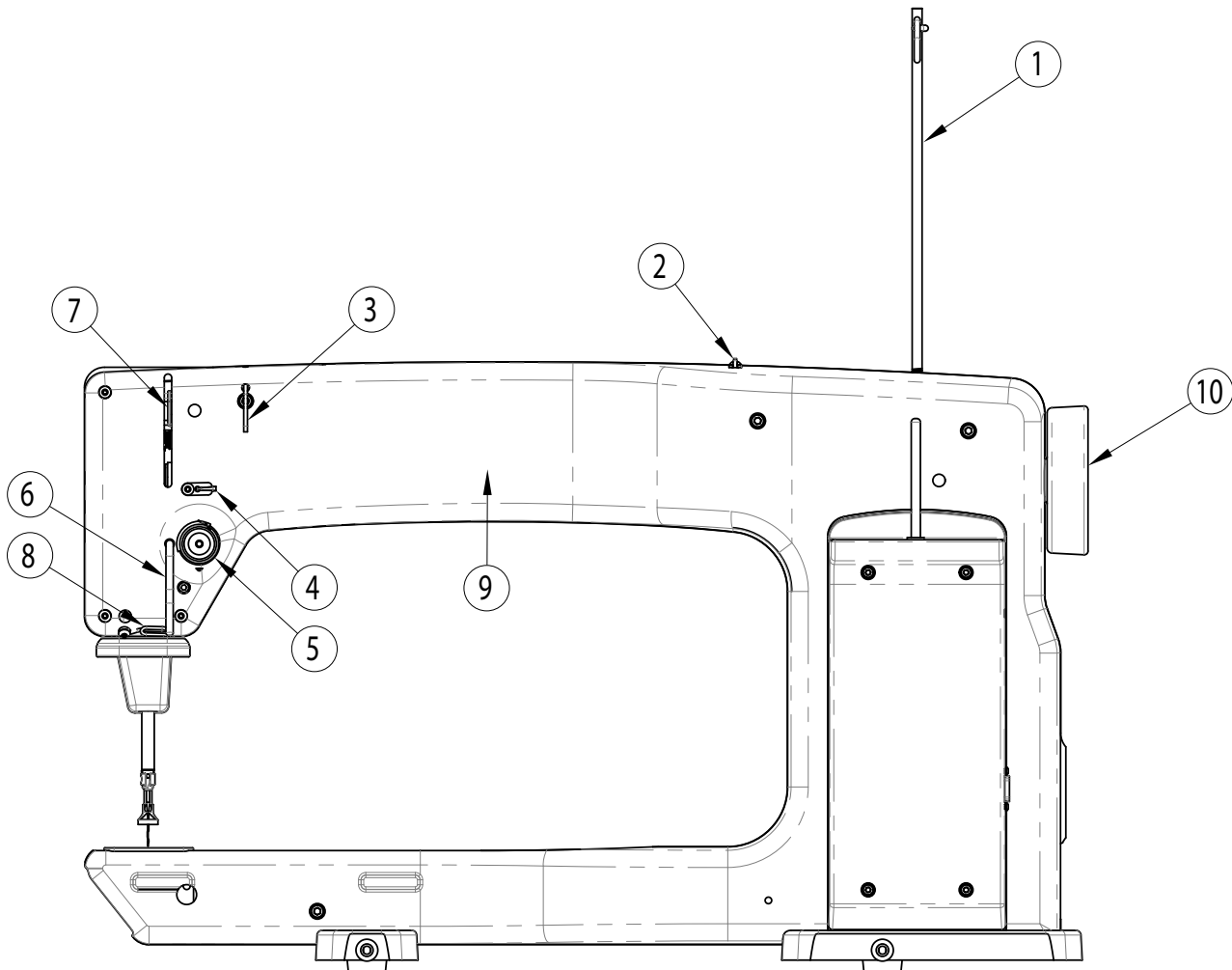

Figure 2

1. Thread Antennae
2. Thread Guide A
3. Three-Hole Thread Guide B
4. Thread Guide C
5. Top Thread Tension Assembly
6. Stirrup Thread Guide E
7. Take-Up Lever
8. Thread Guide F
9. Front Casing/Frame
10. Handwheel

Back Side View

- 11. Needle Bar
- 12. Needle Bar Clamp Thumb Screw
- 13. Needle Bar Thread Guide
- 14. Needle
- 15. Hopping Foot
- 16. Needle Plate
- 17. Mount
- 18. Presser Bar
- 19. Front Threaded Display Mounting Holes
- 20. Front Base
- 21. Back Casing/Frame
- 22. Rear Base
- 23. Color Touch-Screen Display Connector
- 24. Threaded Horizontal Spool Pin Mounting Hole

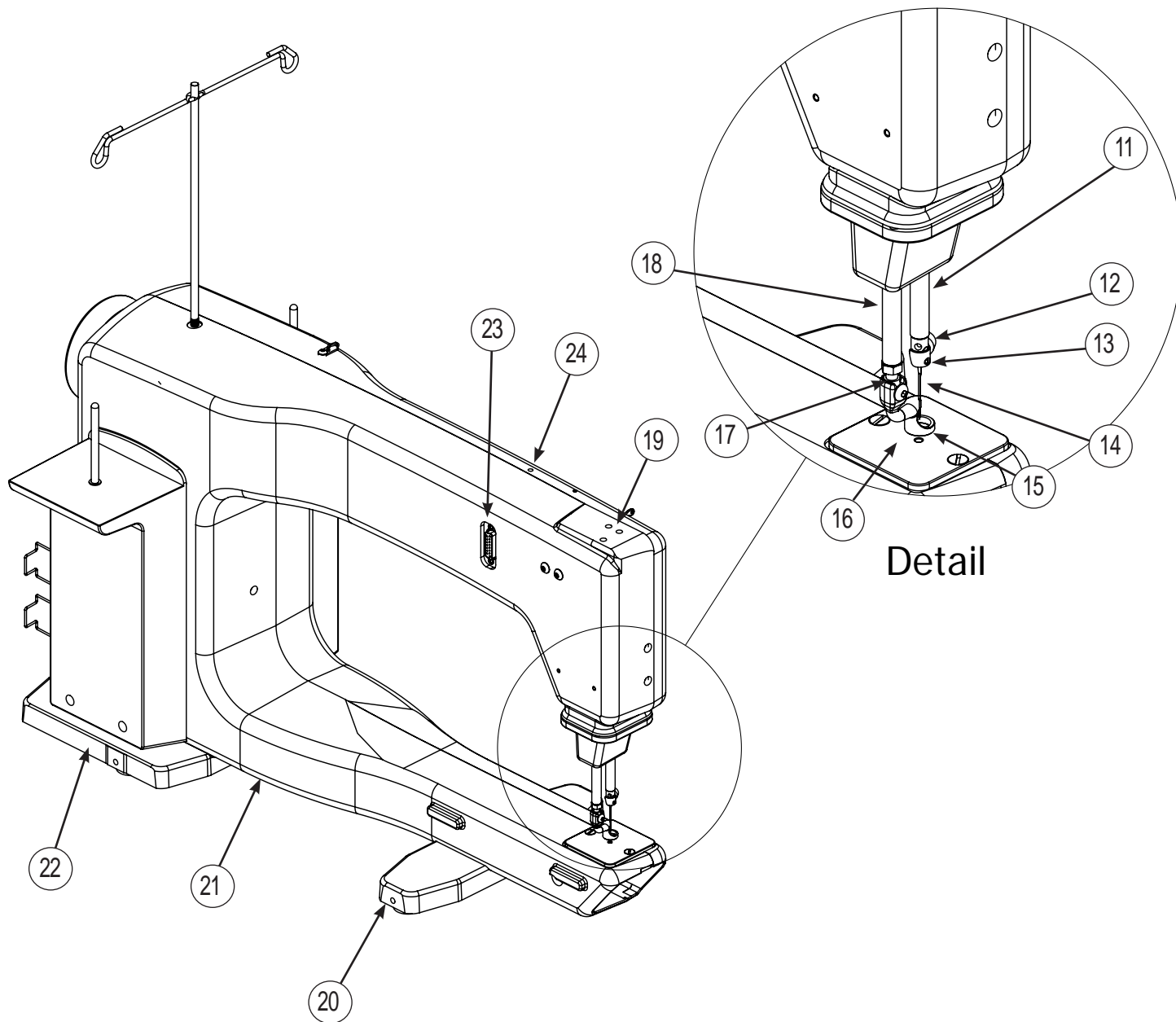

Figure 3

Rear and Front Views

- 25. On/Off Switch
- 26. Power Cord Connector
- 27. Accessory Power Connector
- 28. Foot Pedal Connector
- 29. Spool Pin 1
- 30. Electronic Control Pod (C-Pod)
- 31. Bobbin Assembly

- 32. LED Light Ring
- 33. Power Pod (P-Pod)
- 34. Spool Pin 2

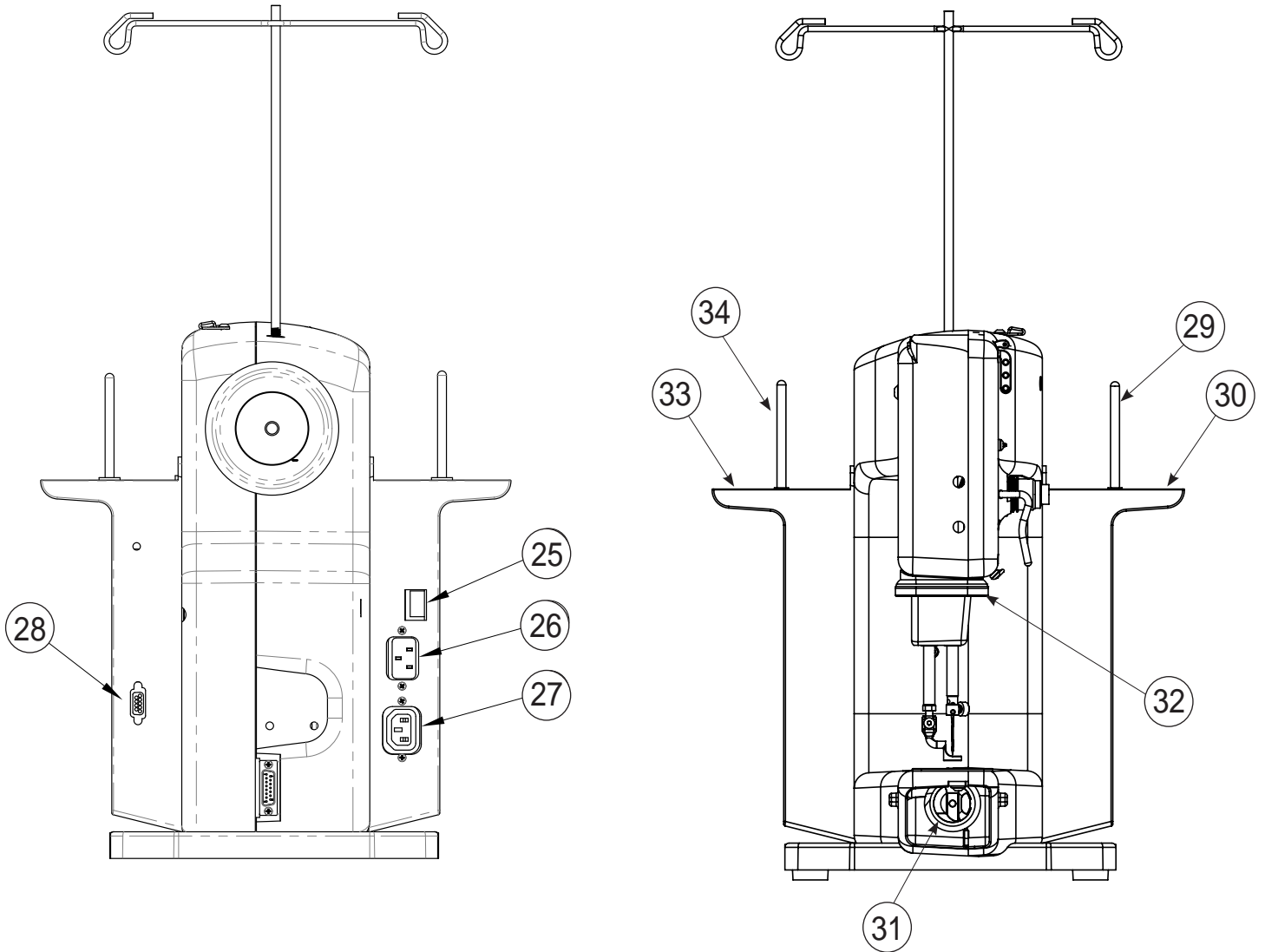

Figure 4

Installation and Setup

Setting Up the Table (and Taking it Down for Storage)

The Baby Lock Tiara III table has been designed to accommodate the Baby Lock Tiara III machine. It has folding legs that are height-adjustable and is heavy enough to provide stabilization for quilting at high speeds.

1. Open the box and gently remove the table, taking care not to drop the table on the floor. The table weighs over 50 pounds, so it is recommended that you ask someone for assistance.
2. Remove shipping brace from underneath quilting table by removing the two bolts holding it in place.
3. Unfold the legs by pulling on the horizontal braces, while being careful not to pinch fingers, until the legs snap into place.
4. Make the table taller by pinching the two height-adjustment tabs on each set of legs and lifting on table, while holding legs down with your foot. Make the table shorter by pinching the same tabs and pushing down on the table.
5. To store the table, remove machine and return legs to their lowest position.
6. The legs are attached to the table top with brackets of two different sizes. One is longer than the other. Identify the long and the short leg brackets.
7. Fold in the short bracket leg first. Push on the horizontal braces to loosen the legs and push them back toward the table top.
8. Repeat with the long bracket leg.

Placing the Machine in the Table

We recommend having someone help lift and place the machine into the table.

1. Lift the machine by putting one arm through the throat space.
2. Guide the machine from the back of the table into the slot. Machine is positioned correctly when the back of the machine is flush with the back of the table.

Installing the Power Cord

Check that the On/Off switch (see page 12, Figure 4, #25) is turned off (the 0 setting). Plug the power cord into the top power outlet on the back of the machine (Figure 5). Do not plug the power cord into an electrical outlet at this time.

The accessory power connector (see page 12, Figure 4, #27) is available for powering future attachments as they are developed by manufacturer. (Not yet available.)



Figure 5

Installing the Foot Pedal

1. Plug in the foot pedal cord end into the foot pedal connector (see page 12, Figure 4, # 28).
2. Place the foot pedal under the table where operator can reach it from the front of the machine.

Installing the Thread Antennae

Locate the threaded hole on top of the machine near the rear by the handwheel.

2. The thread antennae comes with a washer and a nut. Remove the nut and washer, replace the nut onto the antennae and tighten for two or three turns.
3. The washer protects the painted surface when the nut is tightened. Place the washer on the hole and insert the thread antennae.
4. Turn the thread antennae clockwise several revolutions, stopping when the antennae eyelets are positioned directly over the spool pins.
5. Tighten the nut to secure the thread antennae to the machine.



 **NOTE:** The eyelets of the thread antennae **MUST** be centered over the spool pins. This ensures that the thread cone will not pull, turn or tilt, which will cause thread tension problems (see Figure 6).



Figure 6

Installing the Color Touch-Screen Display

The color touch-screen display comes pre-installed on its mounting bracket and should have one end of the D cable attached to the back of the touch screen (see Figure 7).

 **NOTE:** Confirm that the power is turned off before installing the touch-screen display.

1. Remove the two long bolts from the bag in which they are packed.
2. There are three holes on top of the machine head (see page 11, Figure 3, #19). Only the two holes that are in line with each other are used. Ignore the third hole located to the side of these two holes.
3. Align the holes in the color touch-screen bracket with the two holes on top of the machine, with the touch-screen display facing the needle end of the machine.
4. Use a 5mm Allen wrench to insert the two long bolts through the holes of the bracket and into the machine (Figure 7). Tighten in place.
5. Plug the remaining cable end into the display connector located on the side of the machine (see page 11, Figure 3, #23).
6. Carefully remove the protective plastic from the touch-screen display before using.



Figure 7

Inserting or Changing the Needle

The needle that is in the machine when it arrives at your home has been used for 20 minutes of testing. It is possible that it could be damaged in shipping or as you remove the machine from the box. For these reasons, Baby Lock recommends that you replace the needle before beginning to quilt with your new machine.

1. Move the needle bar to the highest position by turning the handwheel.
2. Confirm that the power is turned off and that the machine is unplugged.
3. Loosen the needle bar clamp thumb screw with the disc-shaped screwdriver or fingers (see Figure 8) enough to assure that the needle can be inserted all the way up to the top of the sight hole.

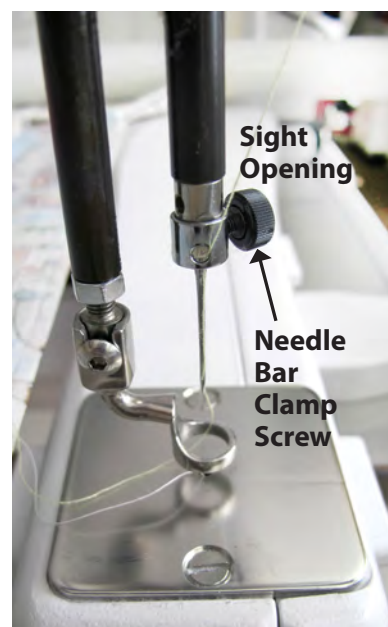

Figure 8

4. With the scarf (small recess area on the back side of the needle just above the needle eye) facing the handwheel location of the machine, and the long groove down the front of the needle facing the bobbin case side (see page 15, Figure 8), push the needle all the way up inside the needle bar – until it can go no further. Look into the sight hole to verify that the butt of the needle reaches the top of the sight hole.

➡ **IMPORTANT:** If the needle is not fully inserted inside the needle bar, the machine timing will be off and it may be possible for the needle to collide with internal parts causing damage not covered by warranty.

5. Carefully tighten the needle bar clamp thumb screw. Over-tightening the thumb screw will result in damaged threads or stripping of the screw hole. A side effect of damaged threads from over-tightening the needle bar clamp thumb screw is that it may become difficult to insert the needle properly into the needle bar. Stripped holes are not covered under warranty. When tightening the thumb screw using the disc-shaped screwdriver, gently turn the screwdriver until the screw is tightened snugly. This will avoid over-tightening the screw.

✂ **NOTE:** Changing the needle is recommended for each new quilt sewn with the machine or any time the needle becomes bent, dull or burred. Needles are inexpensive and are important to the success of your project. Plan to change needles every 5 to 7 hours of quilting or more often if working with a lot of fusibles or heavy materials. Quilt batting dulls needles quickly.

⚠ **CAUTION:** Never leave machine unattended while plugged in. Always unplug this machine from the electrical outlet immediately after using and before maintenance.

Needle/Thread Selection Guide

Needle Size	Thread weight
12 (80)	Monofilament, 100 wt. Silk, 60 wt. poly, mylar
14 (90)	Silk (100 wt), 60 wt., monofilament, glitter, some metallics
16 (100)	60 wt., 50 wt., 40 wt., monofilament, glitter, metallics
18 (110)	50 wt., 40 wt., 30 wt., metallic
20 (125)	30 wt., 20 wt., 12 wt.

Changing the Hopping Foot

Your machine comes with two hopping feet: a ruler foot and an open-toe foot. Use the ruler foot for ruler work and everyday quilting, and the open-toe foot when you need greater stitch visibility (such as micro quilting).

1. Remove the foot that is on the mount by using the 2.5mm Allen wrench to loosen the mounting screw far enough that you can slide the foot off of the mount.
2. Slide the desired foot onto the mount (Figure 9). Note that the opening on the side of the foot is lined up with the screw hole. Push the foot up as far as it will go.



Figure 9

3. Ensure the middle of the foot opening is centered with the needle when the foot is fully tightened with the 2.5mm Allen wrench. If it isn't properly centered, loosen the lock nut; center the foot with the needle; hold the foot in position; and firmly tighten the lock nut (Figure 10).



Figure 10

Threading the Machine

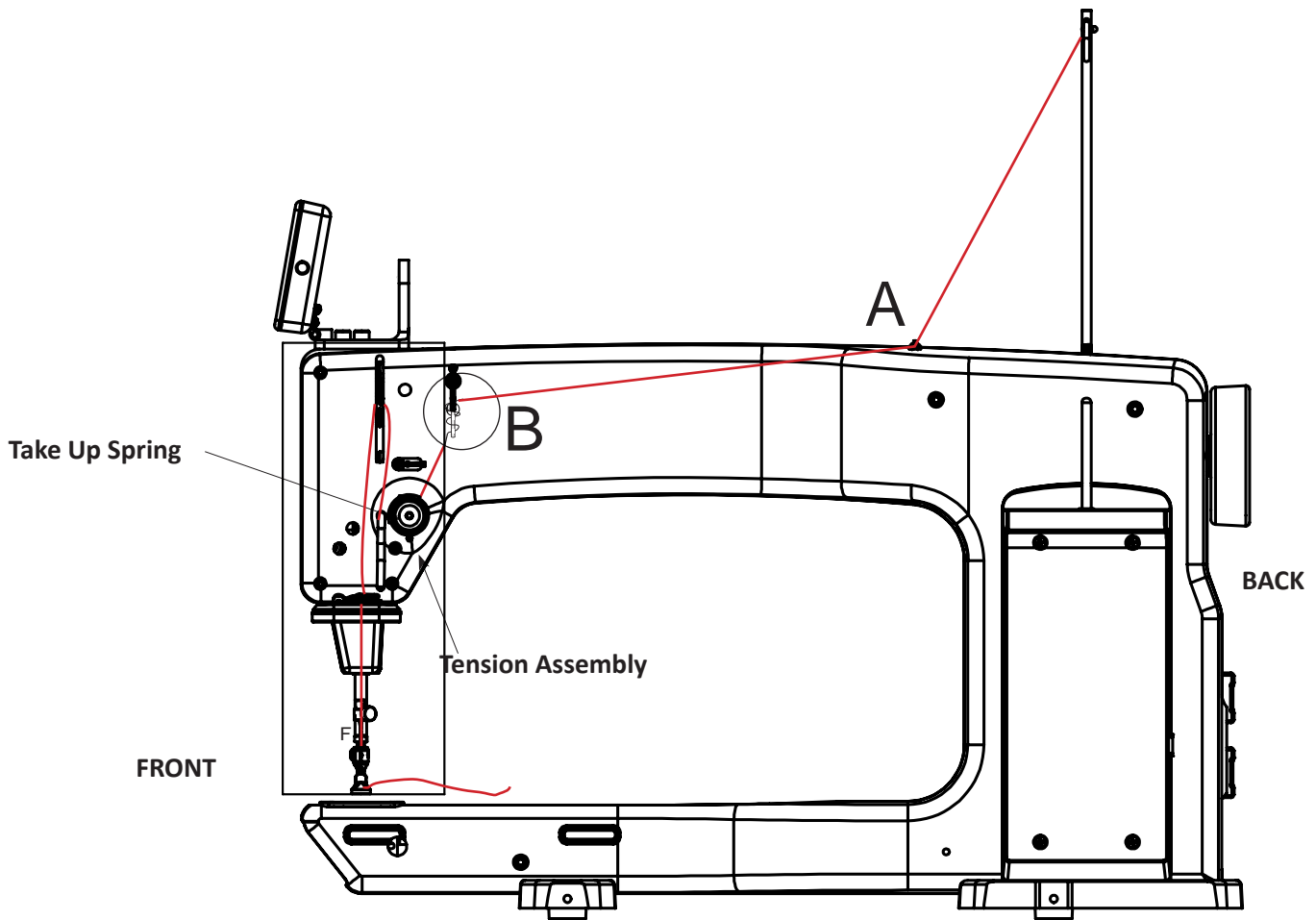

Figure 11

1. Place a cone or spool of thread on the spool pin. If using a spool, make sure that the slits on the spool are against the base of the spool pin holder. Pass the thread through the thread antennae eyelet from back to front, continuing to thread guide A (Figure 11).
2. Continue to the three-hole thread guide B. Beginning at the top of the guide, wrap all three holes from back to front, handwheel side to needle side being careful not to cross threads (see Figure 12).

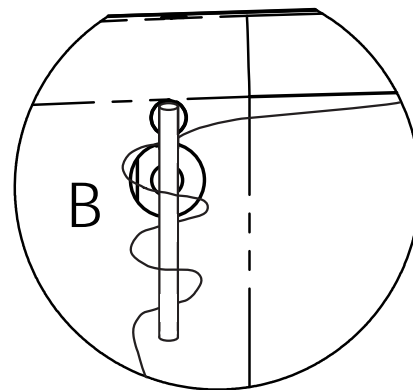



Figure 12

 **NOTE:** The purpose of the three-hole thread guide B is to prevent loops of thread coming off the thread cone from going into the top tension as a knot causing thread breakage and bad tension. For most threads on a cone, it is important to thread all three holes for consistent results and to make adjustments at the top tension assembly. An exception to this rule is when working with very delicate threads, such as holographic or threads that are prone to breakage. You may try skipping one or two holes on thread guide B when using these threads.

3. Thread continues through thread guide C, and then down to the tension assembly (see Figure 13).

 **NOTE:** It is important that the thread is *flossed* between the two tension discs. If the thread is not firmly in place between the two tension discs, the thread will rest on the outside of the tension discs (without tension) and looping on fabric or thread nests may occur.

4. Once the thread is in place, be sure that the thread catches on the take-up spring and then pull it down under the stirrup thread guide D.

5. Bring the thread back up through the take-up lever from back to front, and then down through thread guide E. Pull the thread at the take-up lever to ensure that it is properly flossed between the tension disks. If it is properly flossed in the tension disks you should feel some resistance as you pull the thread. If thread is not properly in the tension disks, then the thread will pull freely with no tension. If this is the case, then rethread the machine.

6. Pull the thread down to the needle thread guide and thread through the hole for thread guide F (see Figure 13).

7. Make sure the thread is following the groove down the front of the needle and insert thread through the eye of the needle from front to back. Be careful that the thread does not twist around the needle.

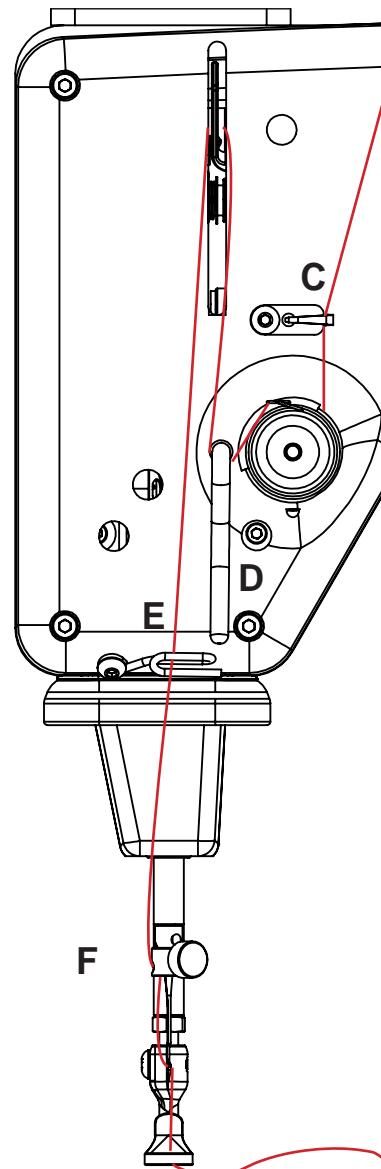

Figure 13

- ➡ **IMPORTANT:** The Baby Lock Tiara III quilting machine does not have a presser foot lever or top tension release like a home sewing machine. On a home sewing machine the top tension is released when the presser foot is raised, allowing the thread to come freely out of the machine.

When a home machine is threaded, the presser foot is raised and the tension discs are released and open for the thread to easily fall between the tension discs. This is not the case with the Baby Lock Tiara III quilting machine where the top tension is always tight and the tension discs are never open. Therefore, the thread must be pulled up, or *flossed*, between the tension discs or it will stay outside the discs and float without tension, causing serious stitch problems and/or thread nests.

- ➡ **IMPORTANT:** It is also possible to bend the needle while it is threaded if care is not taken while moving the machine around the quilt because the top tension is never released.

Bobbin Case and Bobbin Thread Tension Adjustments

Inserting the Bobbin into Bobbin Case

- ✍ **NOTE:** To prevent personal injury always turn off the power switch while inserting and removing the bobbin case or anytime your hands are near the needle area.

1. Place the bobbin in the bobbin case so that the thread pulls off clockwise when viewing the open side of case (Figure 14).
2. Slide the thread through the slot (see page 21, Figure 15) and under the tension spring leaving 5 to 6 inches of thread hanging loose (see page 21, Figures 15 and 16).

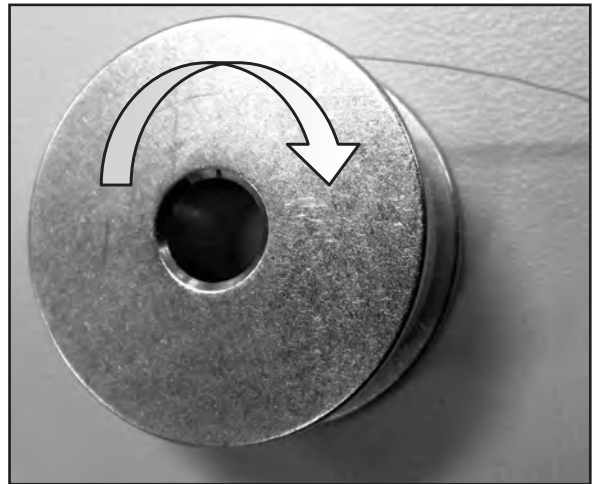

Figure 14

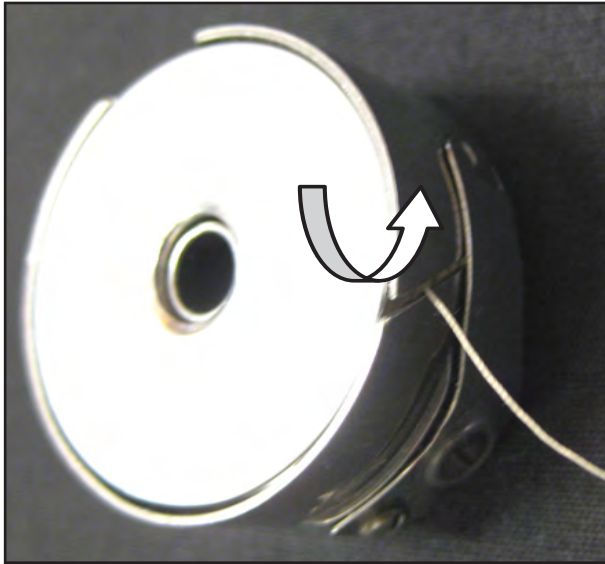

Figure 15



Figure 16

3. To insert the bobbin case into the machine, grasp the bobbin case with thumb and index finger. Do not lift the lever on bobbin case. Fit the bobbin case onto the hook spindle in the machine. Rotate the case until the open throat keys into the alignment notch in the middle of the hook. Push the case in until it stops in place. Push the case inward further until it clicks (see Figure 17). Allow the thread end to hang freely.



Figure 17

 **NOTE:** Pulling out the latch lever pushes the bobbin forward in the bobbin case, aiding in removal of the bobbin. The lever should be used only for removing the bobbin case from the machine, not while inserting.

Drawing the Bobbin Thread to the Top of the Quilt

1. After threading the machine and inserting the bobbin case, plug machine in and turn on the power. Place quilt sandwich under hopping foot.
2. While firmly holding the tail of the needle thread with the left hand, choose one of the following methods to cycle the needle through one full rotation in order to bring the bobbin thread to the top of the quilt.
 - A. **Foot Pedal Method:** Lightly tap the foot pedal to make the needle go down. Then lightly tap again to bring the needle up.
 - B. **Needle Up/Down Button Half-Stitch:** Locate the Needle Up/Down Button in the center of the color touch-screen display. Press once to cycle the needle down. Press again to cycle the needle back up.
 - C. **Needle Up/Down Button, Full-Stitch:** Locate the Needle Up/Down Button in the center of the color touch-screen display. Press and hold briefly to cycle the needle through one complete stitch cycle (down and back up).

3. Pull the fabric 3 to 4 inches away while holding the needle thread.
4. Bobbin thread will pull up and through to the top, allowing you to grasp the loop and pull it to the desired length.

Checking and Adjusting Bobbin Case Tension

The bobbin case tension is the foundation tension for the entire machine. To test that bobbin tension is correct, hold the bobbin case in the palm of your hand with the open end facing up. Wrap the thread around your index finger and lift the bobbin case up from your hand. While gently moving the finger in a left to right motion (not up and down, which is not consistent), the bobbin case should slide slowly down the thread, like a spider on its web.

The small screw in the center of the tension spring is where the tension adjustment is made (see Figure 18). Turn clockwise to tighten and counter-clockwise to loosen the bobbin case tension. Turn the tension adjustment screw in small increments. Check the bobbin tension every time a new bobbin is inserted.

To tighten bobbin case tension

The bobbin case tension is *too loose* if it will not lift up onto its side. Turn adjustment screw clockwise to tighten. The bobbin case adjustment screw requires very small adjustments. Think of the “tick of a clock”. Adjust, then check. Adjust and check again.

To loosen bobbin case tension

The bobbin case tension is *too tight* if it lifts out of your hand. Turn adjustment screw counter-clockwise to loosen. The bobbin case adjustment screw requires very small adjustments. Think of the “tick of a clock”. Adjust, then check. Adjust and check again.



Figure 18

Top Thread Tension Adjustment

- ➔ **IMPORTANT:** Top thread tension should be adjusted only after the bobbin case foundation tension adjustment is made.

Puckering, gathers and thread breakage occur when the top tension is too tight. Loops and thread nests occur on the back when the top thread tension is too loose (see page 23, Figure 19). Tension may need to be adjusted, depending on the fabric, thread or batting used in each project.

As you change the top tension, the value in the tension indicator box on the Main Screen increases or decreases in increments of five. When you are happy with the tension, note the top tension value for that type of thread (brand, weight and color) so you can quickly and easily set the tension when you use this thread again in the future.

Unlike the bobbin case adjustment, which requires minute adjustments (like the ticks of a clock), the top tension knob may require turns anywhere from one quarter of a turn to two to four turns to achieve balanced tension.

To tighten top thread tension

To adjust the top tension tighter, turn the top thread tension knob (see page 10, Figure 2, #5) clockwise.

To loosen top thread tension

To loosen the top tension, turn the top thread tension knob (see page 10, Figure 2, #5) counter-clockwise.

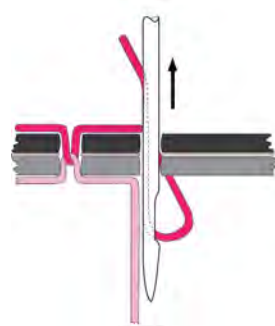

A stitch is balanced when the top thread and the bobbin thread meet in the middle of the quilt sandwich.

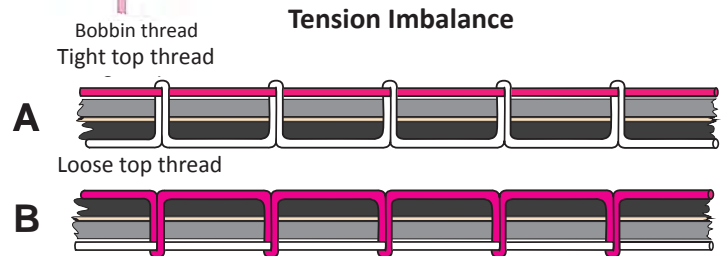



Figure 19

-  **NOTE:** Before adjusting the top tension, remember to floss or pull the top thread up into the tension discs otherwise the top thread will float outside the discs providing little or no top tension. This could cause significant tension or nesting problems on the bottom side of the quilt. If the top tension is too loose (causing loops of thread on the underside of the quilt) and no amount of tightening the top thread tension knob seems to affect it, there's a good chance that the thread is riding on the outside of the tension discs and has not been "flossed" so the thread is lying between the discs properly.

Maintenance

-  **NOTE:** Turn off the machine and unplug the power cord when performing maintenance on the machine.

Cleaning and Lubricating the Machine

Use only good quality light sewing machine oil in the Baby Lock Tiara III. Internal oiling is not necessary on the Baby Lock Tiara III except when the machine is taken to your authorized Baby Lock retailer for routine maintenance and cleaning. The hook assembly, however, needs regular lubricating. Failure to keep the hook assembly lubricated can cause severe damage to the machine.

To lubricate, turn off and unplug the machine. Remove the bobbin and bobbin case before oiling. Clean around the hook assembly with a soft brush to remove lint. Put a very small drop of oil on the hook in the region where the bobbin basket assembly and the rotating hook meet (see Figure 20). The bobbin basket is the portion of the hook that the bobbin case snaps into. The bobbin basket remains stationary while the hook rotates around the basket. The oil lubricates the region where these two components interlock. A drop of oil in the region indicated will work its way back into the interlocking area of the hook and bobbin basket.



Figure 20

The frequency of lubrication depends upon the usage of the machine. Lubricating is recommended before running the machine if it has not been used regularly, or every other bobbin change if used frequently. After oiling, always stitch through a scrap piece of fabric, as oil may cling to thread. Over oiling can cause excess dripping from the bobbin assembly. Lack of lubricant may be noticed by a change in the sound of the machine and will affect stitch quality.

Cleaning the Touch-Screen Display

Use a soft clean cloth dampened with isopropyl alcohol to gently wipe the display and remove any marks. Never use any other chemicals to clean your display as they may adversely affect the display's response and clarity.

Using the Touch-Screen Displays

Main Screen (Figure 21)

The Baby Lock Tiara III has a color touch-screen display on the front of the machine. Settings are changed using this display.

Foot Pedal Status

The status of the foot pedal connection appears in the top-left corner of the Main screen. If the foot pedal is not properly connected, the message *Check Pedal* appears in red letters (Figure 21). After the foot pedal is connected properly the word *Pedal* appears in that space in black letters (Figure 22).

On/Off Indicator

The box in the center of Figure 22 indicates whether or not the motor is running. It will be red when the machine is stopped and green when the foot pedal is pressed.

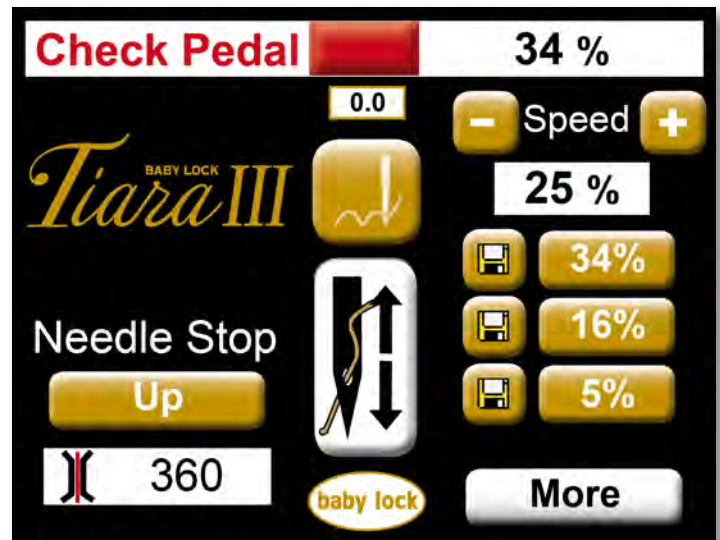

Figure 21



Figure 22

Current Speed

The box in the top-right corner of the Main screen (Figure 21) is the current percentage of full speed the machine is running (Figure 23). The value changes as you press and release the foot pedal. The maximum percentage value that is displayed is controlled by the Limit that is set for the machine.

Speed Controls

The speed box encompasses two main features, the Speed controls and Preset buttons. The Speed controls consist of plus (+) and minus (-) buttons and the white Speed display box (Figure 23). Press the plus (+) button to increase the maximum motor speed the pedal controls. Press the minus (-) button to decrease the maximum speed.

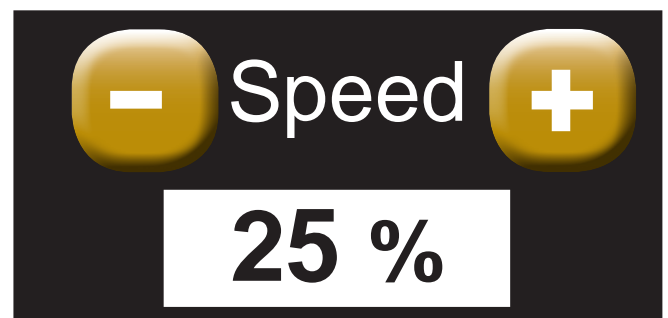

Figure 23

The Speed range is between 5% and 100%, or between 75 and 1800 stitches per minute (SPM). The current percentage Speed value appears in the white box under the Speed text (Figure 23). This Speed setting will be retained when the machine is shut off, enabling you to begin quilting again at the same speed when you turn the machine back on.

Presets

Save up to three preset speeds to quickly switch among speed preferences. For example, you may prefer a slower speed when using rulers and a faster speed when doing all-over meandering quilting (Figure 24).

Use the plus (+) and minus (-) buttons to adjust the speed percentage and then press the Save button next to one of the preset values to store that speed as a preset. When you want to use one of the preset speeds, simply press the speed.

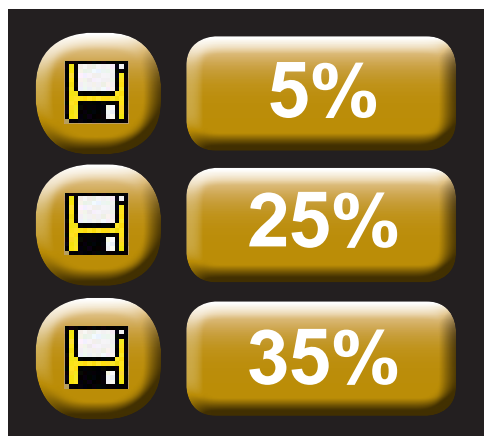

Figure 24

Basting Mode

The Tiara III has a basting mode that causes a stitch to be formed at a specified time interval – every half second, every three-quarters of a second, every second, every 1.5 second, or every two seconds (Figure 25).

Touch the basting icon to activate basting mode. Then press the plus (+) and minus (-) button to set the time interval for the basting stitch (Figure 26).

Press the foot pedal to begin quilting. The Tiara III will take a stitch (needle down and then needle up) at the specified interval. Coordinate how quickly you move the quilt sandwich with how quickly the machine takes a basting stitch. Experiment with the various speed options along with moving the quilt to find which of the settings work best for you to position the basting stitches on your quilt.



Figure 25



Figure 26

Quick Set Tension

The tension box on the Main Screen shows the current tension setting as a numeric value (Figure 27). As you turn the tension dial clockwise to tighten the top tension, the number increases in increments of five. As you turn the tension dial counterclockwise to loosen the top tension, the number decreases in increments of five. The faster you turn the dial, the faster the numbers increase or decrease.

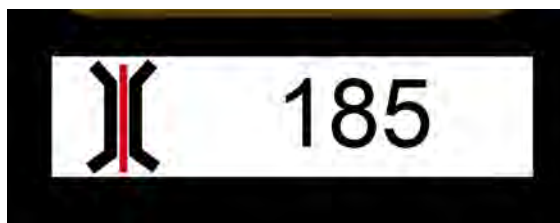

Figure 27

After setting the bobbin tension, test the top tension by stitching on a fabric scrap on the edge of the quilt batting and backing. Increase or decrease as needed until you have achieved balanced tension. Make a note of the type of thread (weight, brand, color) you're using and the tension value. You will be able to quickly and easily set the tension when you use this same thread again in the future.

Bobbin Thread Indicator

If you use the Low-Bobbin feature, the Bobbin Thread Indicator box (Figure 28) shows how much bobbin thread remains on the bobbin. The value counts down until it gets to zero, at which time the low-bobbin alarm alerts you that it is time to put in a new bobbin. While the machine is recording how much thread is on a bobbin, REC appears on the screen to remind you that it is estimating the bobbin capacity.

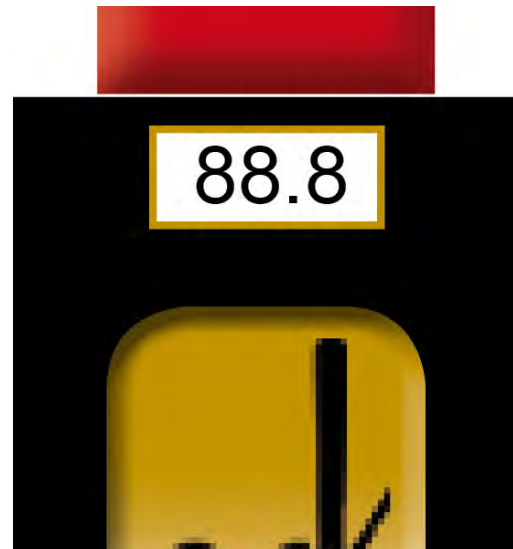

Figure 28

Up/Down/Tie-Off

The button with the needle image in the center of the screen (Figure 29) can assist you in creating tie-off stitches, basting or needle-positioning functions without the use of the foot pedal. Quickly pressing and releasing the button will send the needle to the next needle stop position. If the needle is up, pressing the button causes the needle to move to the down position. If the needle is down, it returns to the up position.

Pressing and holding the button for a longer time performs a full stitch. As long as you continue to hold the button down the machine will continue to stitch at a slow rate, and when the button is released the needle will stop in the closest stop position (up or down) available. This action is useful to tie off beginning and ending stitches.



Figure 29

Needle Stop

The Needle Stop setting enables you to specify whether you want the needle to end in the up or down position when you stop quilting. If you select Down, when you release the foot pedal the needle ends in the down position. If you select Up, the needle ends in the up position when you release the foot pedal. Switch between the up and down position by pressing the Needle Stop button (Figure 30).

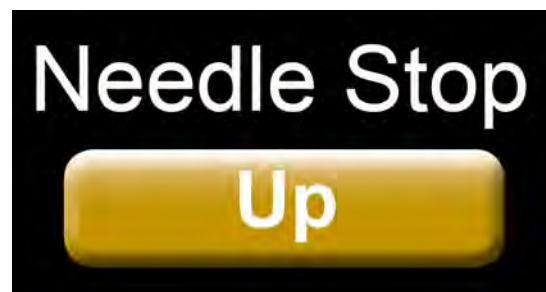

Figure 30

More

Press the More button (Figure 31) on the Main Screen to display more options.



Figure 31

Low Bobbin

The Tiara III includes a low bobbin capability so you can estimate how soon your bobbin thread will run out.

Timers

The Tiara III has two useful timers. One timer enables you to set a reminder alarm (like a kitchen timer) and the other timer tracks how much time you spend on a quilt project.

Options

Press the Options button to open a screen for adjusting the volume of the sound and the brightness of the LED lighting.

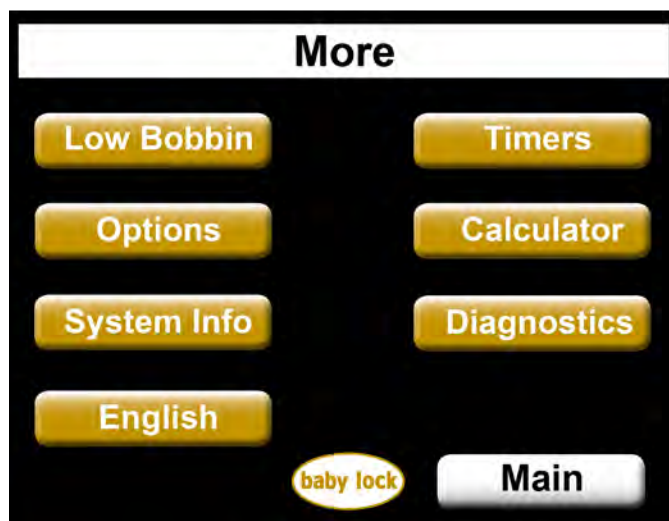

Figure 32

Calculator

An on-screen calculator may be accessed from the More screen.

System Information

The System Info. button provides access to machine information. This includes the machine serial number, the hardware and firmware version numbers and the stitch counters.

Diagnostics

The Diagnostics button opens the screen for performing machine diagnostics. Diagnostic functions are generally only used when working with your authorized Baby Lock retailer to resolve issues.

Set Language

The Tiara III screens can appear in English, French, German or Spanish. On the More Screen, press the lower-left button to cycle between the language options. After selecting your language preference, press Main to return to the Main Screen.

Main

Press the Main button to return to the Main menu screen.

Low Bobbin

The Tiara III includes a low bobbin capability so you can estimate how soon your bobbin thread will run out. This Low Bobbin Capacity is based on an estimate of how much of a particular thread can fit on a bobbin, in combination with other quilting factors such as tension, stitches per inch, and how much bobbin thread you pull up when beginning and ending your quilting (Figure 33).

To estimate how much thread is on a bobbin, place a full bobbin in the machine and under the heading Bobbin Thread Capacity, press the Record button and quilt as usual.

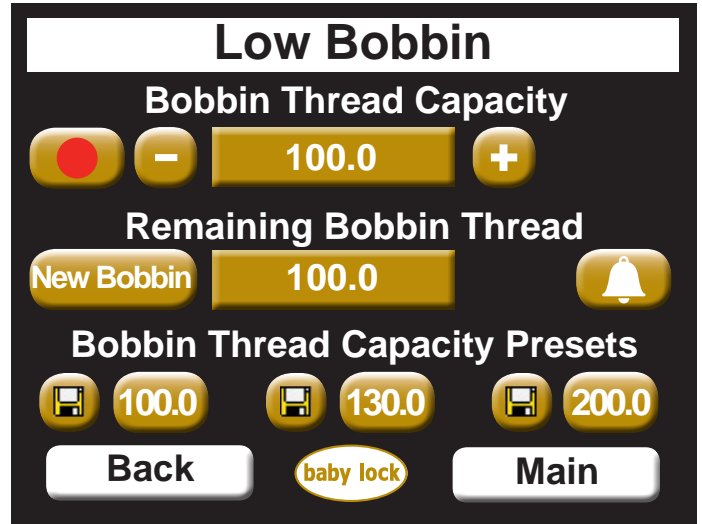

Figure 33

When the bobbin thread runs out, press the square Stop Recording button and note how many yards is indicated under the Bobbin Thread Capacity (Figure 34), perhaps 210 yards. Since you want a warning as to when the bobbin is getting low, use the minus (-) button to specify a lower number, such as 195 yards. Save that as one of the Bobbin Thread Capacity Presets. You might want to make a note as to which type of thread the preset represents. Put a new bobbin with the same thread into the machine and press the New Bobbin button. Then press the Alarm button. As you quilt, the remaining bobbin thread value will estimate how much thread remains on the current bobbin, and when you reach the capacity value, an alarm will sound warning you that your bobbin is nearly out of thread (Figure 35).

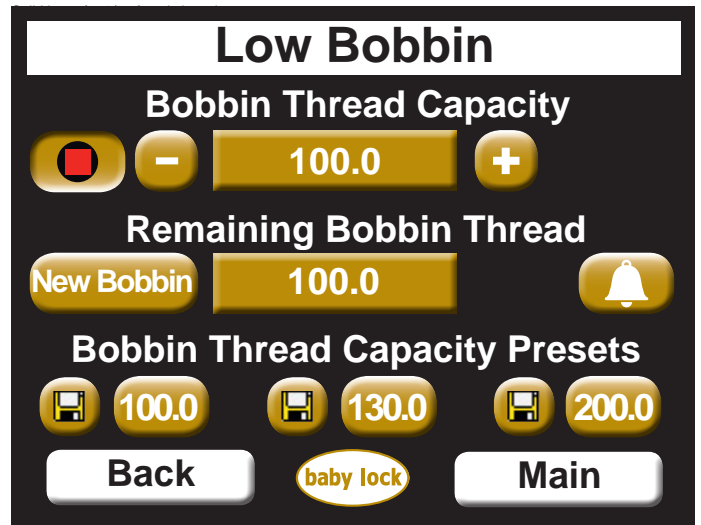

Figure 34

When recording the capacity of a bobbin, the Tiara III assumes you will stitch at 10 stitches per inch if TruStitch stitch regulation (optional accessory) is not attached to your machine. Therefore, if you estimate bobbin capacity and stitch using different stitches-per-inch, increase the capacity setting (if stitching fewer than 10 stitches per inch) or decrease it (if stitching more than 10 stitches per inch).

If TruStitch is attached and powered on, the low-bobbin capacity calculation uses the current last TruStitch stitches-per-inch setting to calculate bobbin capacity when you are stitching in regulated mode. In Manual mode the last stitches-per-inch setting used in regulated mode is used to calculate the bobbin usage.

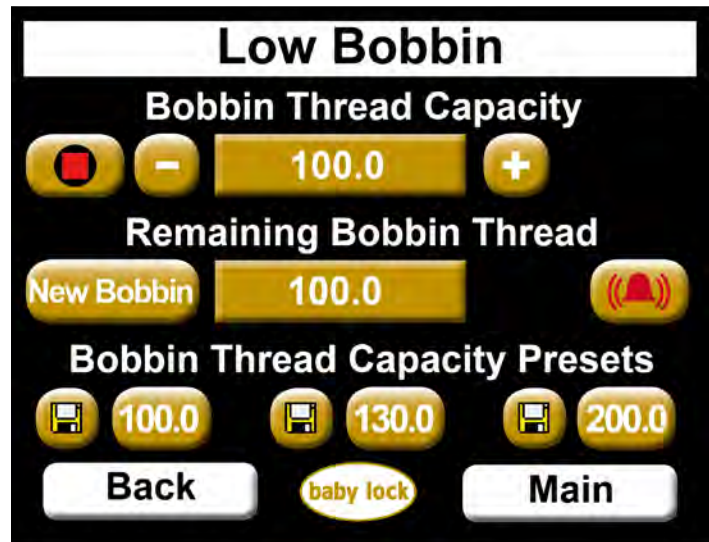

Figure 35

You can store three Bobbin Thread Capacity preset values – one for each of three different types of thread. Simply go through the record process with a full bobbin of that type of thread and then store the capacity as a preset. When you switch to using that type of thread, press appropriate preset button. Insert a full bobbin with that type of thread, press New Bobbin, and all of the settings will be based on that type of thread.

Timers

The Tiara III has two useful timers. One timer enables you to set a reminder alarm (like a kitchen timer) and the other timer tracks how much time you spend on a quilt.

The first (top) timer is a reminder timer. It enables you to set an alarm to go off after a specific period of time, similar to a kitchen timer. Use the plus (+) and minus (–) buttons to set the time duration. Then press the “play” button to activate the timer. When the time duration has elapsed, an alarm will sound and a message appears on the display.

The second (bottom) timer enables you to track how much time you spend on a quilt project. When you begin a new project, press the Reset button. Then press the Play button to begin recording your quilting time. The timer records when the machine is quilting. The time is saved even when the machine is turned off. When you begin another quilting session, quilting time is added to the timer. Only press Reset when you want to zero-out the timer and begin a new timing session (Figure 36).

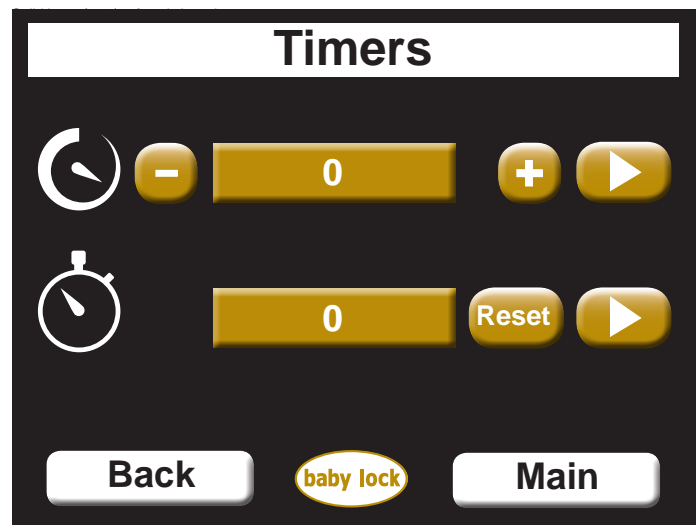

Figure 36

Options Screen (Figure 37)

Volume

The Volume portion of this screen has two buttons and a sliding control. Press the Mute button to turn off the sound of the buttons when they are pressed. Press the Maximum button to turn the volume to its loudest level. Move the sliding control to any position to vary the percentage of maximum volume indicated in that control. Press and move the slider back and forth changes the volume up as it is moved left to right and down as it is moved from right to left.

Brightness

The Brightness portion of this screen has two buttons and a sliding control as well. Turn on the LED Light Ring by pressing the illuminated light bulb button. Turn it off by pressing the darkened light bulb button. Move the sliding control to any position to set the brightness to the value indicated in the slider.

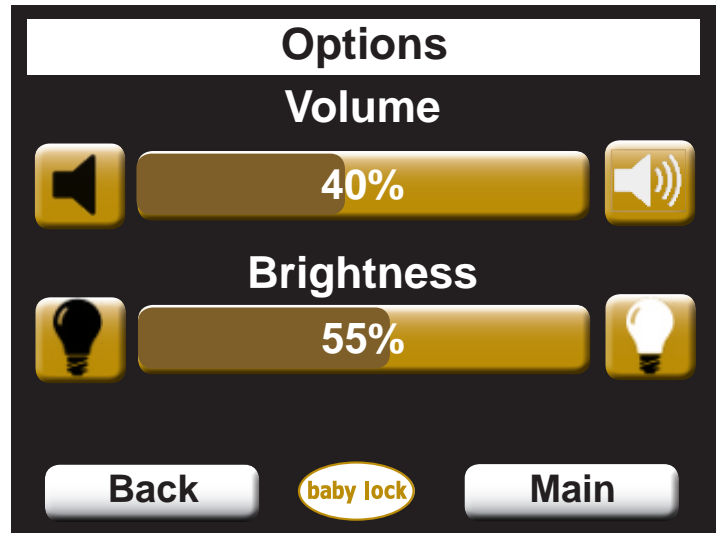

Figure 37

Calculator Screen

A basic six-function calculator is provided for your convenience (Figure 38). The functions provided are addition, subtraction, multiplication, division, square root and percent. The arrow button on the top right may be used to delete a digit mistakenly entered.

Press the Main button to return to the Main menu screen or the Back button to return to the More menu screen.

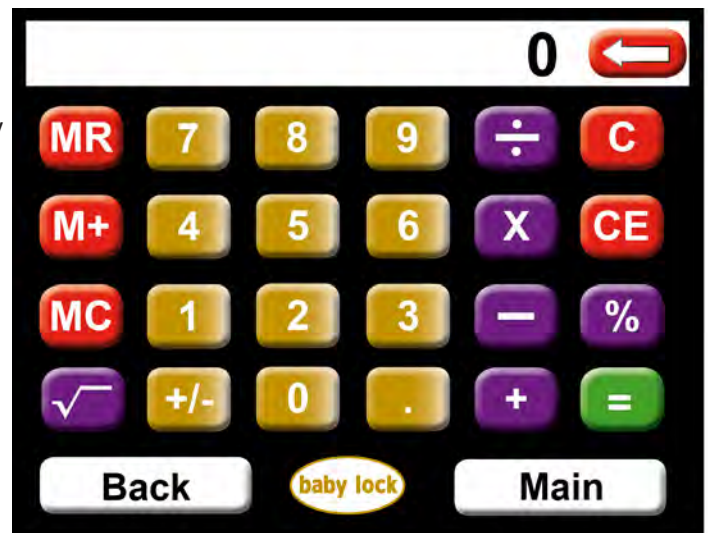

Figure 38

System Information Screen

The machine serial number is displayed at the top of the System Information screen. This number matches the one found on the label at back of machine.

Information contained in the white boxes below the serial number identifies the electronics board version numbers as well as the firmware version numbers of the Baby Lock Tiara III.

The Lifetime and Trip (or project) stitch counters count the number of stitches the machine has performed. The Lifetime count is the total number of sewn stitches since the machine was built. The Trip Counter can be reset to keep track of the number of sewn stitches during a given project. To reset this counter, press the Reset button to the left of the Trip counter.



Figure 39

The Lifetime counter cannot be reset and should be used as an indicator to determine when general machine maintenance should be performed by your authorized Baby Lock retailer (Figure 39).

- **Important maintenance message:** Baby Lock recommends taking your machine to an authorized Baby Lock retailer for a regular maintenance check. Such steps will help to ensure you receive continued, uninterrupted hours of machine operation for the future.

Press the Main button to return to the Main menu screen or the Back button to return to the More menu screen.

Diagnostics Screen (Figure 40)

Four different diagnostics tests can be performed on the machine. These functions test the motor control operation, the foot pedal and the internal position sensors.

Press the Main button to return to the Main menu screen or the Back button to return to the More menu screen.

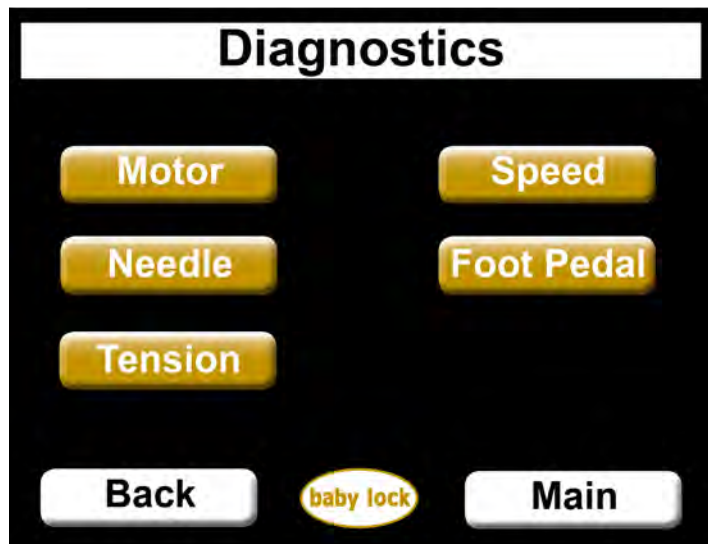

Figure 40

Diagnostics Tests

Motor Sensor Test

The Motor Sensor test can help you determine whether they may be a problem with the Baby Lock Tiara III motor. Slowly rotating the handwheel should result in an audible beep. If you get a constant solid beep or no beep at all, this indicates a failed test and the machine should be inspected by your authorized Baby Lock retailer. (Figure 41).

Needle Sensor Test

The Needle Sensor test will indicate whether the needle position sensor is functioning properly. Rotating the handwheel should result in a beep for half of a stitch cycle followed by no beep for the other half (Figure 42).

If you hear a constant beep or no beep at all for a full 360° rotation of the handwheel, this indicates a failed test and the machine should be inspected by your authorized Baby Lock retailer.

Press the Main button to return to the Main menu screen or the Back button to return to the More menu screen.

Speed Sensor Test

The Speed Sensor test can help you determine whether or not there is a problem with the Baby Lock Tiara III speed sensor. Before performing this test, remove the bobbin case and the top thread. Press the foot pedal so that the machine will begin slowly rotating. The white box will show a number that should stabilize at 100 if the sensor is functioning properly. Release the foot pedal to stop the machine (Figure 43).

Press the Main button to return to the Main menu screen or the Back button to return to the More menu screen.

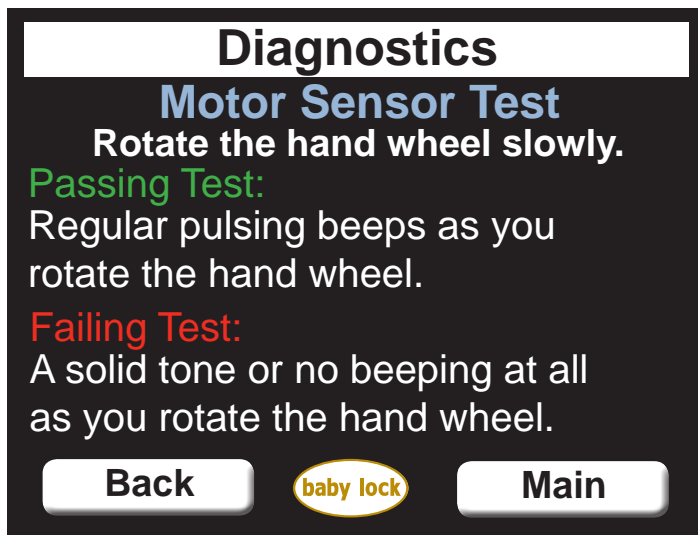

Figure 41

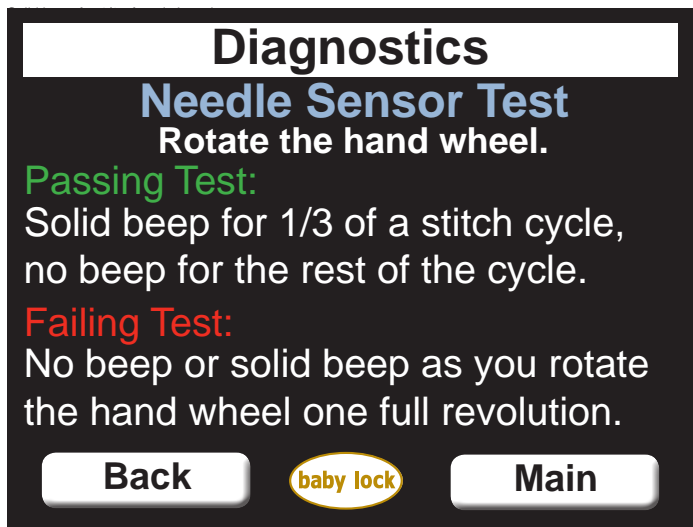

Figure 42

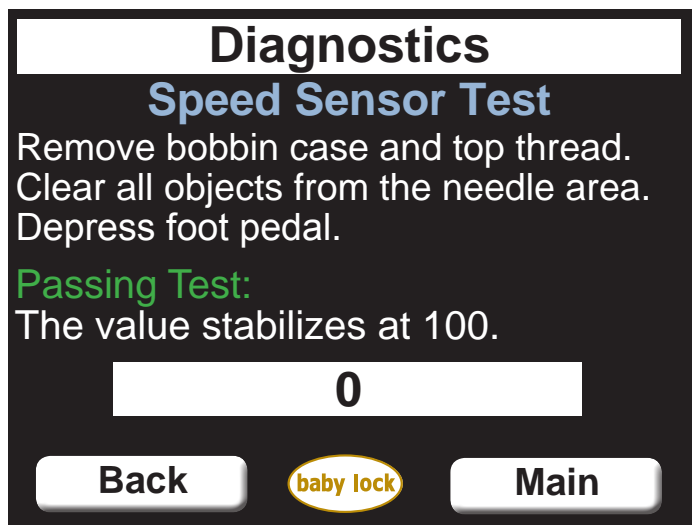

Figure 43

Foot Pedal Test

The Foot Pedal test can help you determine if there is a problem with the Baby Lock Tiara III foot pedal. As you slowly depress the foot pedal a percent of depression will appear in the white box. The foot pedal should be controllable from 0 to 100% (Figure 44).

Press the Main button to return to the Main menu screen or the Back button to return to the More menu screen.

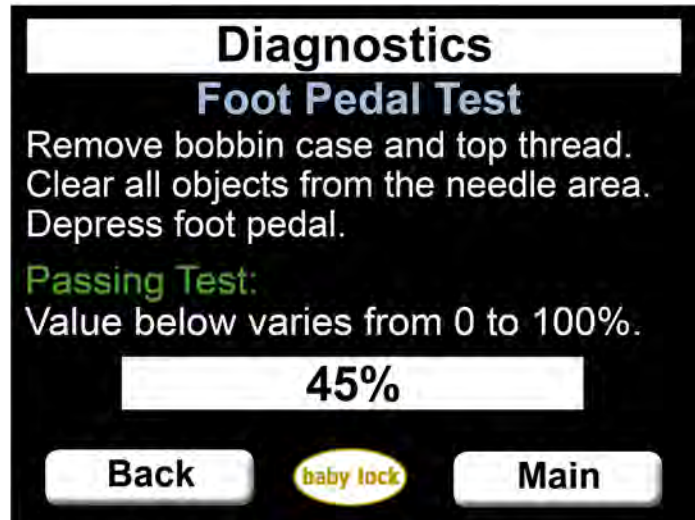

Figure 44

Tension

The Tension button on the Diagnostics menu enables you to calibrate the tension device. You should only calibrate the tension device under the direction of your authorized Baby Lock retailer (Figure 45).

While calibrating the tension, you will be asked to do the following:

1. Remove the tension knob.
2. Gently press the spring against the tension discs while not compressing the spring.
3. While holding the spring in place, press Reset.
4. When calibration is complete, replace the tension knob.

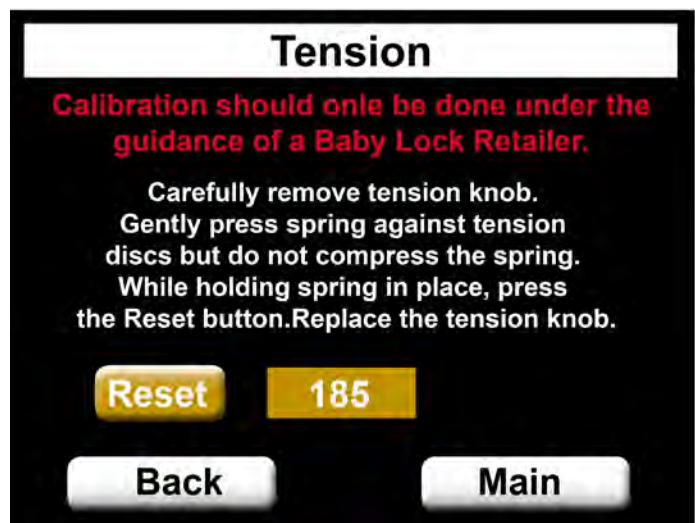

Figure 45

Preparing to Quilt

Thread Requirements

Threads have a tendency to dry rot over a period of time. Be sure to choose high-quality threads for your valuable heirloom quilts. Most machine quilting threads on the market today are acceptable.

Needle Requirements

For general quilting, a size 16/100 needle will accommodate most threads and fabrics. Heavier threads, such as top stitch and some decorative threads, require a larger needle such as 18/110 or 20/125. Heavier fabrics such as denim, canvas or densely woven fabric may require a larger needle.

To Prepare for Quilting

With any quilting machine, it is important to understand the basics of free motion quilting. The Baby Lock Tiara III does not have feed dogs like domestic machines; therefore, the fabric does not automatically feed under the hopping foot. The operator controls the machine sewing speed with the My Speed setting and the foot pedal, and moving the fabric to get an even, consistent stitch.

In order to become comfortable using the Baby Lock Tiara III, quilters can begin with a few simple techniques using a sample quilt sandwich (two pieces of fabric with a layer of batting between them).

Set the machine at a medium My Speed setting (perhaps 25%) then begin moving the fabric until you become accustomed to the resistance and the rhythm of the machine. By moving the fabric faster, the stitches begin to elongate. The My Speed setting can either be increased or the fabric can be moved slower to get the stitches back to the desired length. By moving the fabric slower, the stitches get shorter and can build up on top of each other, breaking the thread or making it extremely difficult to remove threads.

The My Speed setting can be decreased or the foot pedal released slightly, while maintaining a constant motion with the fabric, to bring the stitches back to the desired length.

When quilting, relax your hands and maintain a light touch on the fabric. Gripping the fabric too tightly may cause body tension resulting in poor quilting quality and discomfort.

Different colors of fabric may require different brightness settings for the LED light ring to prevent eye strain.

Troubleshooting

Skipped Stitches	Corrective Measure
<ul style="list-style-type: none">The needle is damaged, dull, bent, or installed improperly	<ul style="list-style-type: none">Replace the needle often, normally once or twice per day for continuous quilting or at least once per quilt. Use Baby Lock Tiara III recommended needles.Always change the needle if the needle has struck any hard object such as a straight pin, etc. The tip of the needle can become damaged or burred, resulting in fabric damage as well as skipped stitches, thread breakage or shredding. Damaged needles cannot always be identified with the naked eye.Always change the needle if it has been hit, bumped or pulled off center while maneuvering the machine around the quilt. A slightly bent needle or needle burr can be a major cause of skipped stitches.
<ul style="list-style-type: none">Incorrect needle sizeVery tightly-woven fabric (such as batiks)	<ul style="list-style-type: none">Check for the proper combination of needle size and thread weight being applied to the quilting operation. Some fabrics used in quilting may constrict or impede the thread passing through the front groove of the needle. This diminishes the loop lift required for stitch formation. Typically, a larger needle will solve the problem; however, it has been found that certain smaller sizes of needles as well as the use of ball-pointed needles solve some specific problems.
<ul style="list-style-type: none">Needle has not been positioned properly	<ul style="list-style-type: none">Position the needle properly to the needle bar. Inspect the position of the needle to make sure the needle is at the 6 o'clock position (see <i>Inserting (or Changing) the Needle</i>, Figure 8). When you're sitting directly in front of the needle (facing the bobbin case side of the machine), you will see the entire needle eye directly facing you. This is 6 o'clock position.Make sure (1) the needle is installed all the way inside the needle bar to the needle stop hole in the needle bar, (2) the long groove in the needle is toward the front (bobbin case side), and (3) the scarf/recessed part of the needle is toward the handwheel. The needle can sometimes be rotated to 5 o'clock (slightly right) or 7 o'clock (slightly left) in order to adjust for a more positive thread loop pickup by the hook point.
<ul style="list-style-type: none">Thread tension too tight	<ul style="list-style-type: none">Loosen top tension. Re-check top and bobbin tension. (See <i>Bobbin Case and Bobbin Thread Tension Adjustments</i> and <i>Top Thread Tension Adjustment</i>.)
<ul style="list-style-type: none">Improper threading	<ul style="list-style-type: none">Inspect that the thread take-up lever, thread stirrup or tension spring are all threaded correctly.

The Needle Breaks

Corrective Measure

- The needle is bent or not installed properly
- The needle hits the needle plate
- Replace or correctly insert the needle. Make sure that the needle is pushed up inside the needle bar clamp until it can go no farther (visually check that it is up to the top of the stop/sight hole above the needle bar clamp screw). Failure to do so can cause damage in the bobbin area and throat plate.
- Correctly position the needle, needle plate or hopping foot. Replace needle with a new one.

Stitches are Puckered

Corrective Measure

- Tension is not balanced
- Needle too large for material
- Balance the tension of the needle thread after ensuring the bobbin tension is adjusted correctly. (See *Bobbin Case and Bobbin Thread Tension Adjustments* and *Top Thread Tension Adjustment*.)
- Replace the needle with a size better suited to the fabric.

Stitch Quality is Poor

Corrective Measure

- Tension is not balanced
- Bobbin case is damaged, corroded, dirty, et cetera
- Moving the fabric or pressing the foot pedal inconsistently
- Adjust the tension of the needle thread after ensuring the bobbin tension is adjusted correctly (see *Top Thread Tension Adjustment*).
- Since thread slides over the surface of the bobbin case at a high speed, make sure the case is free of any lint or foreign matter that could impede thread passage through the machine.
- The My Speed setting should be adjusted to a value that will allow you to sew comfortably and confidently with the foot pedal fully depressed. Discover a method of holding the fabric that is most comfortable.

Tension is Poor

Corrective Measure

- Lint caught under the tension spring in the bobbin case
- Poorly wound bobbin
- Lint and other material can build up under the tension leaf spring and begin to lift the spring. This reduces the spring's ability to compress against the thread. By inserting a needle under the spring and clearing out the lint, the bobbin tension will return to the previously set tension.
- If the bobbin is wound too tight or too loose it can lead to poor and inconsistent tension. Make sure when the bobbin is wound that the thread tension is not so tight that the wound bobbin thread feels hard and causes the bobbin sides to bulge. It should also not be so loose that the thread is spongy, which can cause the thread to tangle as it unwinds.

Handwheel Won't Rotate

Corrective Measure

- Thread is entangled and caught in the hook
- Turn off the machine and remove the power plug from the electrical outlet. Remove the bobbin case from the machine. Lubricate the hook, then manually rotate the handwheel clockwise and counter-clockwise several times. Remove the thread caught in the hook.

Thread Nests Under the Quilt

Corrective Measure

- Not enough tension on top thread
- Check that the machine is threaded correctly. Make certain that the thread is flossed snugly in place between the two tension discs. If the machine is correctly threaded, tighten the top tension by rotating the tension knob clockwise.
- Improper threading
- Refer to the threading diagram and threading instructions in the section titled Threading the Machine.

Motor Fails to Run

Corrective Measure

- On/Off switch is off or power cord is loose
- Turn the machine on only by using the switch on the back of the power pod. Verify the power cord is plugged in tightly at both the machine and the power source.
- Foot pedal is unplugged
- Verify that the foot pedal is plugged in. If the main screen status message in the upper left hand corner states "Check Pedal", then the pedal is not properly installed.

Needle Thread Breaks

Corrective Measure

- Top and bobbin tension not balanced
- Check the tension of the top thread tension assembly and bobbin for proper balance. (See *Bobbin Case and Bobbin Thread Tension Adjustments* and *Top Thread Tension Adjustment*.)
- Thread cones/spools are poor quality or may have severe twisting or thread rot
- Look for severe twisting of threads when approximately 12 to 15 inches has been pulled off, with ends pinched together. Cotton threads are particularly susceptible to dry rot which makes thread brittle. Do not use poor quality thread, or thread that is rotted or brittle.
- The machine head has been threaded incorrectly or thread spools are not positioned correctly
- Check that the machine is threaded correctly.
- Inspect for accidental double wrapping of thread on thread guides.
- Inspect the thread antennae making sure the eyelets of the antennae are directly over the spools.
- Inspect the vertical positioning of the thread cones. Tipped cones can dramatically affect thread tension and can cause breakage.
- Particles in tension discs
- Inspect for particles and remove any lint or debris.
- Bobbin rotation is not smooth
- Change the bobbin. The slightest hesitation of the bobbin rotation can be the cause of dramatic tension change and thread breakage. Use ONLY Baby Lock bobbins

- Needle is burred, bent, dull, or installed incorrectly
- Needle not suited for the thread
- Hesitating too long at one point in the pattern
- Improper needle/hook relationship
- Damage or burr at the needle hole in the needle plate or any other place along the thread path
- Wrong type of needle
- Other possible causes:
- Change the needle at least once per quilt. Make sure the needle is installed to the top of the sight hole inside the needle bar.
- Replace the needle with one better suited for the thread. Use the proper size needle.
- Move more quickly so stitches don't overlap or build up. When starting the machine, begin moving immediately. Sewing in one place too long will cause the thread to break.
- Timing of the machine is improper. Consult a your authorized Baby Lock retailer.
- If the thread is shredding at the needle plate, check for burrs or jagged edges. Gently rub with metal cloth to remove the sharp edge. Consult your authorized Baby Lock retailer to polish any hard to reach or delicate areas, or if the burr is inside the hole.
- Use needles recommended by Baby Lock. Using the wrong needle with a smaller shank diameter causes many problems. For example a system 1738 or 287WH needle with a shank diameter of 1.64mm will fit loosely inside the needle clamp at an angle. This may cause skipped stitches because the needle is positioned too far away from the hook point. It can also cause the needle to hit the hook, breaking the needle.
- The needle is too close to the hook, which causes friction and a possible collision of the hook point and the needle.
- Needle plate damage.
- Hook damage.
- Broken needle inside needle bar clamp, preventing insertion of the needle to the top of the needle clamp.
- Damaged needle bar clamp.

No Visible Display

Corrective Measure

- Cable unplugged
- Check the communication cable that connects the display to the machine and make sure the connection is secure.