

Lithoform, *Colorsync Porcelain*.

Inspired by the enduring beauty of limestone, the Lithoform collection channels nature's calm through earthen shades and refined textures.



Inspirée par la beauté intemporelle du calcaire, la collection Lithoform canalise le calme de la nature à travers des nuances terreuses et des textures raffinées.  
Inspirada en la belleza perdurable de la piedra caliza, la colección Lithoform canaliza la calma de la naturaleza a través de tonos terrosos y texturas refinadas.  
Kireç taşının kalıcı güzelliğinden ilham alan Lithoform koleksiyonu, toprak tonları ve rafine dokularla doğanın sakinliğini yansıtıyor.

anatolia

Lithoform, *Colorsync Porcelain.*

A quiet tribute to the natural  
artistry of stone, composed  
in soft, sophisticated tones.

*The World of Anatolia*

Passionate, dedicated and driven to bring together truly exceptional products that embody modernity, innovation and refinement. Anatolia provides its partnering customers across the world access to an extensive inventory as well as superior service, establishing itself among the largest tile and stone brands in the world.

anatolia

## COLORSYNC PORCELAIN

<sup>EN</sup> Colorsync is Anatolia's exclusive porcelain body technology, engineered to deliver seamless visual integration between surface design and body composition. By blending a curated mix of base colors, Colorsync creates a refined, cohesive aesthetic that syncs with the surface graphic. Precision craftsmanship and advanced innovation ensure exceptional performance and a design-forward look from surface to core.

<sup>FR</sup> Colorsync est la technologie exclusive d'Anatolia pour la porcelaine, où l'art rencontre l'innovation. Conçue avec le plus grand soin, elle fusionne le design de la surface et la base du matériau pour une intégration visuelle parfaite. En mélangeant une sélection de couleurs de base, Colorsync crée une esthétique raffinée et cohérente qui s'harmonise avec le graphisme de la surface. Guidée par une innovation de pointe et façonnée avec précision, Colorsync allie performance et élégance dans une expression unique et durable.

<sup>ES</sup> Colorsync es la tecnología exclusiva de Anatolia para porcelana, donde el arte se une a la innovación. Meticulosamente diseñada, fusiona el diseño de la superficie y la composición del cuerpo en una integración visual perfecta. Al combinar una mezcla seleccionada de colores base, Colorsync crea una estética refinada y cohesionada que se sincroniza con el gráfico de la superficie. Guiada por la innovación avanzada y moldeada por la precisión, Colorsync une rendimiento y elegancia en una expresión única y duradera.

<sup>TR</sup> Colorsync, Anatolia'nın sanat ve inovasyonu bir araya getiren, özel olarak geliştirilmiş porselen gövde teknolojisidir. Bu teknoloji, yüzey tasarımı ile gövde yapısını kusursuz bir uyum içinde bütünleştirerek, yüzeyden çekirdeğe kadar devam eden estetik bir bütünlük sunar. Özenle seçilmiş temel renklerin dengeli birleşimi sayesinde, yüzey grafiğiyle tamamen uyumlu, zarif ve tutarlı bir görünüm elde edilir. İleri mühendislik ve titiz işçilikle hayata geçirilen Colorsync, dayanıklılığı ve zarafeti bir arada sunarak, yüzeyden çekirdeğe kadar eşsiz bir uyum yaratır.

## Colors at a glance

A study in subtlety—an ode to limestone’s organic elegance, reimagined through a palette of muted tones that range from cool and airy to warm and grounded.



Crosscut Dunes



Veincut Dunes



Crosscut Vista



Veincut Vista



Crosscut Coast



Veincut Coast

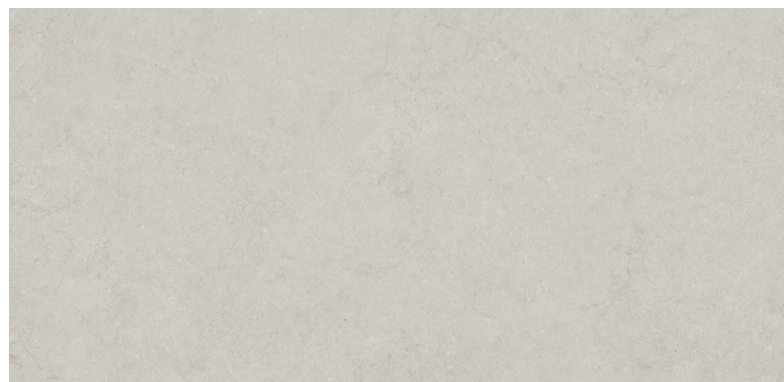

Crosscut Twilight



Veincut Twilight

## Collection sizes at a glance

The extensive formats, colors, and finishes offered are perfect for a wide variety of design styles and spaces.



63 x 126 x 0.24 in / 160 x 320 x 0.6 cm\*  
Rectified Sintered Slab  
Honed / Organic Matte

Available in Crosscut and Veincut

\*Only available in colors Flint, Shale, and Crater.



48 x 110 x 0.24 in / 120 x 280 x 0.6 cm  
Rectified Porcelain Slab  
Honed / Organic Matte

Available in Crosscut and Veincut



12 x 24 in / 30 x 60 cm  
Rectified  
Honed / Organic Matte / Vintage  
Available in Crosscut and Veincut



24 x 48 in / 60 x 120 cm  
Rectified  
Honed / Organic Matte / Vintage

2cm Rectified Paver - Vintage  
Available in Crosscut and Veincut

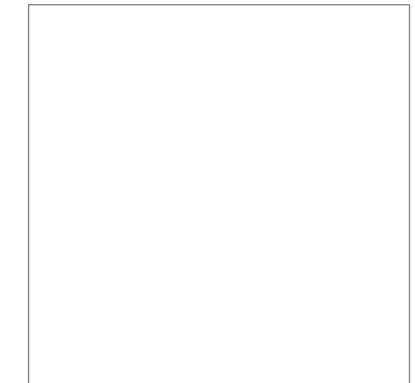

48 x 48 in / 120 x 120 cm  
Rectified  
Honed / Organic Matte

Only available in Crosscut

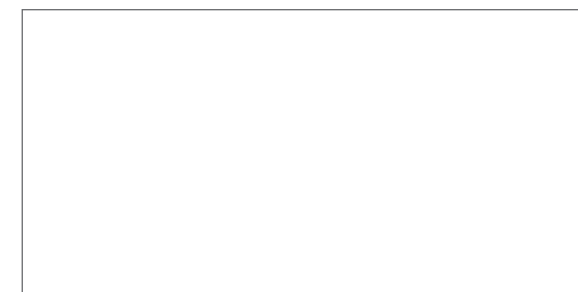

36 x 72 in / 90 x 180 cm  
Rectified  
Honed / Organic Matte / Vintage

Only available in Veincut

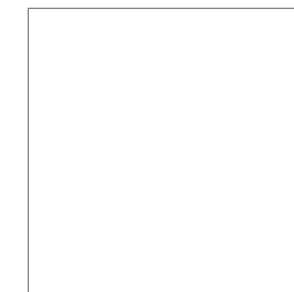

36 x 36 in / 90 x 90 cm  
Rectified  
Honed / Organic Matte  
2cm Rectified Paver - Vintage

Only available in Crosscut



24 x 24 in / 60 x 60 cm  
Rectified  
Honed / Organic Matte / Vintage

Only available in Crosscut

### Mosaics



4 in / 10 cm  
Hexagon Mosaic  
Organic Matte

Only available in Crosscut

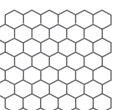

2 in / 5 cm  
Hexagon Mosaic  
Organic Matte

Only available in Veincut

## FINISHES



Lithoform Veincut Coast



Serena Shale



Lithoform Crosscut Dunes

### HONED

<sup>EN</sup> Experience the elegance of Honed surfaces, where every surface is meticulously smoothed to perfection through cutting-edge mechanical innovation. This achieves an ultra-flat, matte finish that offers a soft touch and understated allure, exuding enduring beauty.

<sup>FR</sup> ADOUCI – Découvrez l'élégance des surfaces adoucies, sublímées par un polissage de précision réalisé grâce à une technologie mécanique de pointe. Elles dégagent une sensation de calme et de pureté, et révèlent un raffinement discret et durable.

<sup>ES</sup> APOMAZADO – Viva la elegancia de las superficies Apomazadas, en las que cada superficie es meticulosamente trabajada hasta lograr máxima suavidad por medio de una innovadora tecnología mecánica. El resultado es un producto ultrasuave al tacto, sutilmente seductor, que rezuma perdurable belleza.

<sup>TR</sup> HONLU – Her yüzeyin en ileri düzey mekanik yeniliklerle kusursuz bir şekilde pürüzsüzleştirildiği honlu plakalar, ultra düz ve mat bir yüzey elde edilmesini sağlar. Yumuşak dokunuşu ve abartsız zarafetiyle öne çıkan bu yüzey, zamana meydan okuyan bir güzellik sunar.

### ORGANIC MATTE

<sup>EN</sup> Embrace the understated charm of Organic Matte surfaces, where the surface offers natural quality, emphasizing authenticity and earthy sophistication. Enhanced by a fine structural texture synchronized with the graphic using the latest technology, this finish delivers subtle impressions that enrich the surface's graphic qualities.

<sup>FR</sup> MAT ORGANIQUE – Les surfaces au fini mat organique révèlent un charme discret, porté par une texture naturelle qui souligne l'authenticité et une élégance sobre aux accents minéraux. L'effet visuel, à la fois brut et travaillé, renforce l'authenticité du matériau et lui confère une allure naturelle et sophistiquée.

<sup>ES</sup> MATE ORGÁNICO – Elija el sutil encanto de las superficies Mate orgánico, cuya textura, recreación de la naturaleza, rinde culto a la autenticidad y la sofisticación terrea. Realzado por una noble textura estructural en sincronía con el planteo gráfico, la cual se logra por medio de tecnología de vanguardia, este acabado presenta sutiles patrones de diseño que enriquecen el efecto visual de la superficie.

<sup>TR</sup> ORGANİK MAT – Doğallığın zarif ve kendine has dokunuşu. Organik mat yüzeyler, abartıdan uzak şıklığı ve özgün karakteriyle öne çıkar. Gelişmiş teknolojiyle, desenle senkronize şekilde oluşturulan ince yapısal dokusu, yüzeye ince yansımalar ve derinlik katarak desenin estetik ifadesini daha da zenginleştirir.

### VINTAGE

<sup>EN</sup> Step into timeless elegance with Vintage surfaces, which capture classic beauty through their carefully aged appearance. This rough-textured finish provides a warm, bush-hammered effect, created by advanced glazing and graphical techniques, adding a visual depth and nostalgic touch to contemporary spaces.

<sup>FR</sup> VINTAGE – Les surfaces vintage évoquent une élégance intemporelle, portée par un aspect soigneusement maîtrisé. Leur texture brute crée un effet bouchardé chaleureux, obtenu grâce à des techniques d'émaillage et de traitement graphique avancées. Ce fini apporte une note de nostalgie raffinée aux décors les plus contemporains.

<sup>ES</sup> VINTAGE – Integre elegancia "sin tiempo" con superficies Vintage, piezas que atesoran la belleza clásica con su aspecto esmeradamente envejecido. Gracias a avanzadas técnicas de esmaltado y recursos gráficos, este acabado de textura áspera crea un cálido efecto abujardado, dando un toque de nostalgia a los espacios contemporáneos.

<sup>TR</sup> VINTAGE – Zamansız zarafeti geçmişin izleriyle buluşturan Vintage yüzeyler, özenle eskitilmiş dokusuyla klasik güzelliği günümüze taşır. Gelişmiş sırlama ve grafik teknikleriyle şekillenen bu yüzey, sıcak bir bush-hammered / çekiçlenmiş yüzey etkisi sunar; modern mekânlara görsel bir derinlik ve nostaljik bir dokunuş katar.

# Lithoform Crosscut, *Dunes. Slabs.*

Embracing a warm and sensitive neutrality through the muted tone of ivory.

Une neutralité chaleureuse et sensible grâce à la tonalité feutrée de l'ivoire.  
Apostando a la cálida y delicada neutralidad de un tono marfil apagado.  
Fildişi tonunun yumuşaklığıyla sıcaklık ve hassas nötrlüğü kucaklamak.

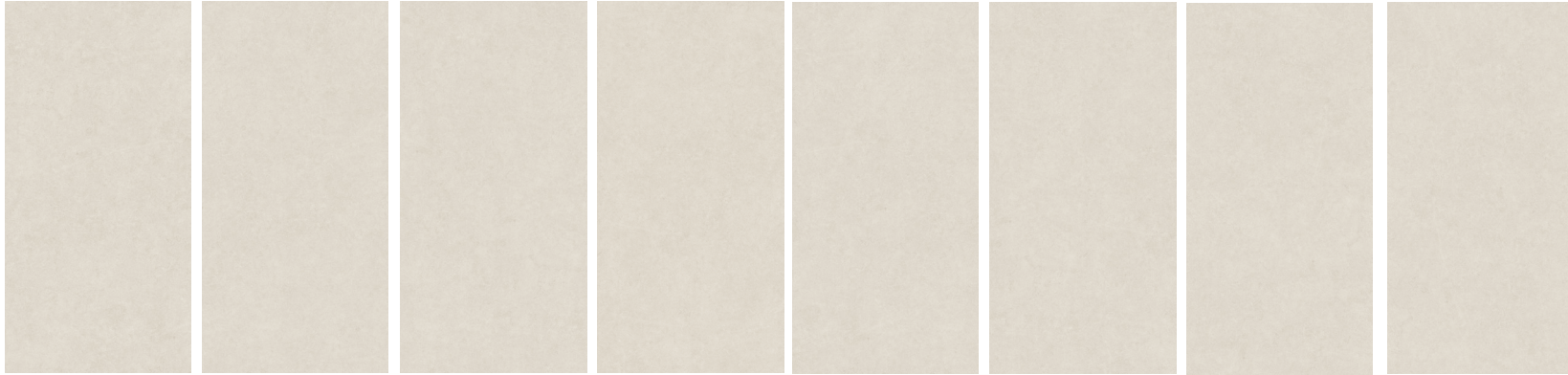

63 x 126 x 0.24 in / 160 x 320 x 0.6 cm  
Rectified Sintered Slab  
Honed 8000-0548-1  
Organic Matte 8000-0550-1

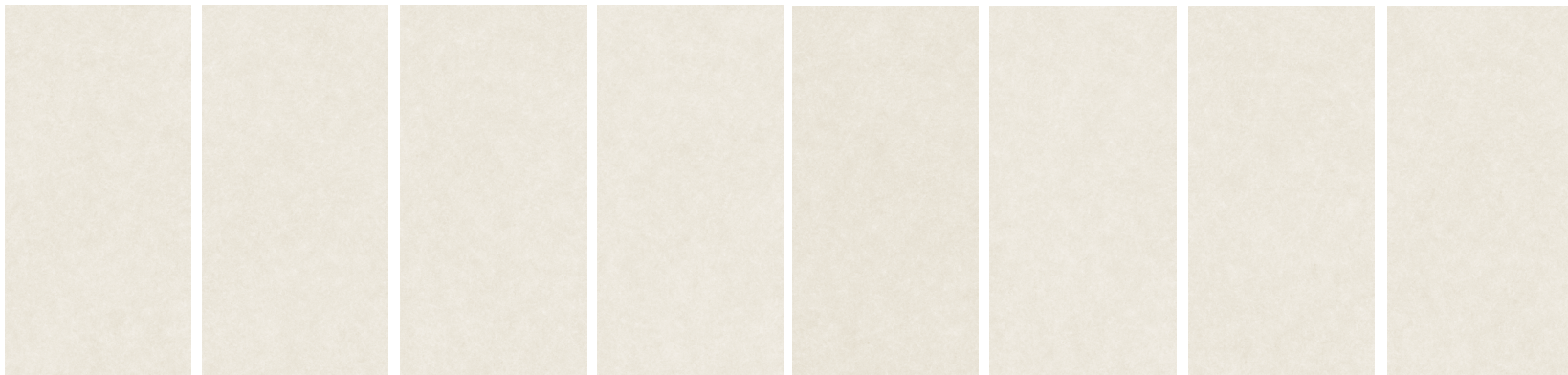

63 x 126 x 0.24 in / 160 x 320 x 0.6 cm  
Rectified Sintered Slab  
Vintage\* 8000-0549-0



### VINTAGE FINISH\*

Advanced glazing and visual alterations give vintage texture depth and an authentically aged appearance.

### IMAGE VARIATIONS

This collection has a wide variety of facings by size to maximize the realism it can convey within a design space.

63 x 126 in / 160 x 320 cm Sintered Slab  
8 images

48 x 110 in / 120 x 280 cm Porcelain Slab  
10 images

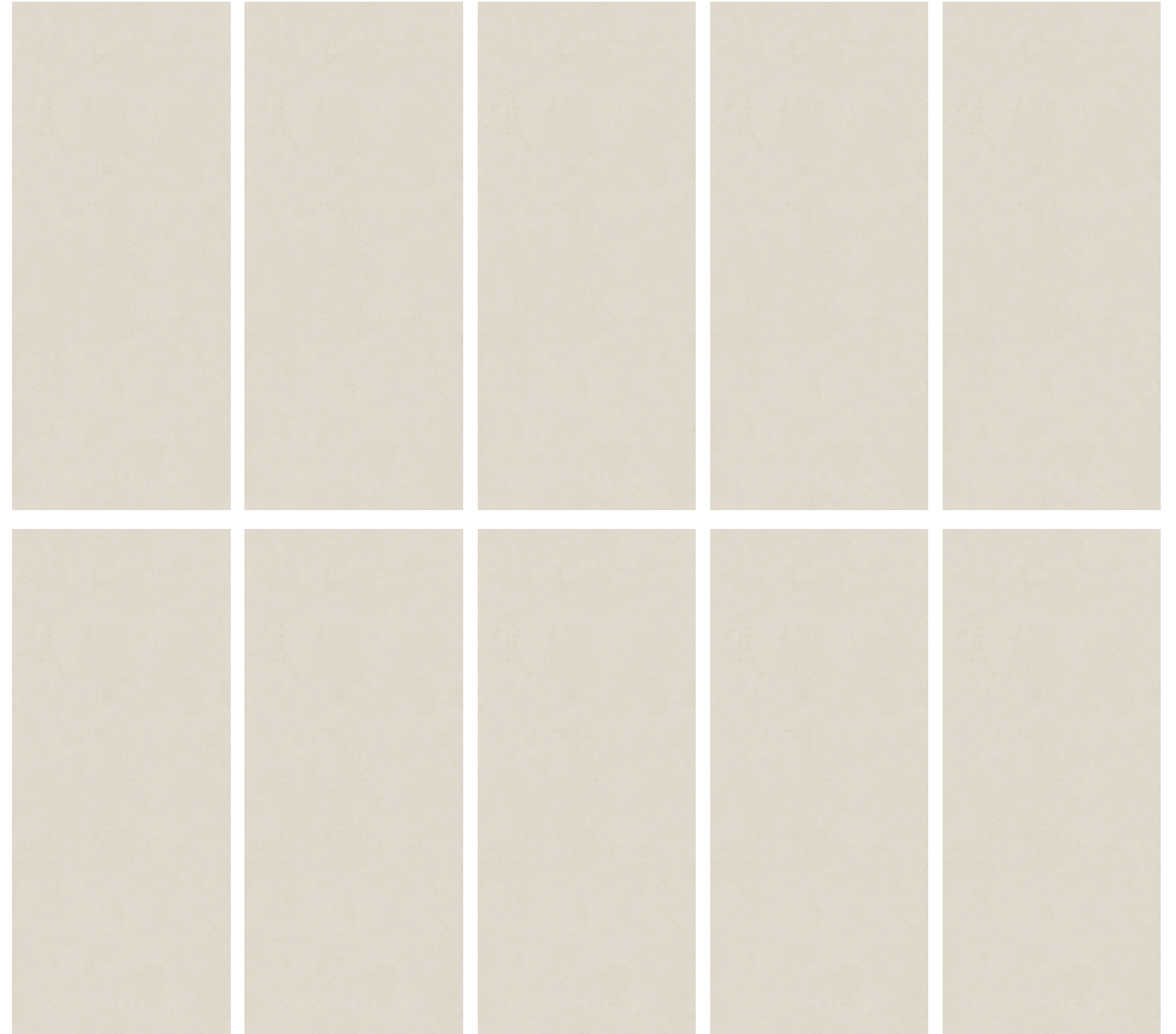

48 x 110 x 0.24 in / 120 x 280 x 0.6 cm  
Rectified Porcelain Slab  
Honed 8500-0080-0  
Organic Matte 8500-0081-0



SLAB DESIGN TYPE: Random

# Lithoform Crosscut, *Dunes. Tiles, Pavers, and Mosaics.*

Embracing a warm and sensitive neutrality through the muted tone of ivory.

Une neutralité chaleureuse et sensible grâce à la tonalité feutrée de l'ivoire.  
 Apostando a la cálida y delicada neutralidad de un tono marfil apagado.  
 Fildişi tonunun yumuşaklığıyla sıcaklık ve hassas nötrlüğü kucaklamak.



48 x 48 in / 120 x 120 cm  
 Rectified  
 Honed 8500-0170-0  
 Organic Matte 8500-0171-0



36 x 36 in / 90 x 90 cm  
 Rectified  
 Honed 8500-0571-0  
 Organic Matte 8500-0572-0



VINTAGE FINISH\*

Advanced glazing and visual alterations give vintage texture depth and an authentically aged appearance.



36 x 36 in / 90 x 90 cm  
 Rectified Paver  
 Vintage\* 8500-0659-0



24 x 48 in / 60 x 120 cm  
 Rectified  
 Honed 8500-0465-0  
 Organic Matte 8500-0466-0

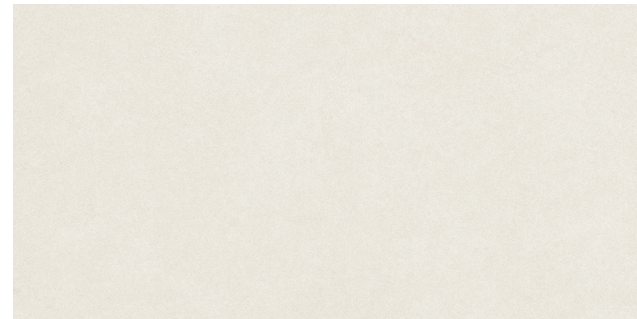

24 x 48 in / 60 x 120 cm  
 Rectified  
 Vintage\* 8500-0467-0  
 2 cm Rectified Paver - Vintage\* 8500-0677-0



24 x 24 in / 60 x 60 cm  
 Rectified  
 Honed 8500-0244-0  
 Organic Matte 8500-0245-0



24 x 24 in / 60 x 60 cm  
 Rectified  
 Vintage\* 8500-0246-0

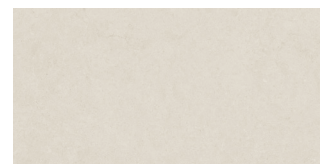

12 x 24 in / 30 x 60 cm  
 Rectified  
 Honed 8500-0343-0  
 Organic Matte 8500-0344-0

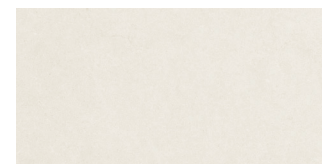

12 x 24 in / 30 x 60 cm  
 Rectified  
 Vintage\* 8500-0345-0

## Mosaic



4 in / 10 cm  
 Hexagon Mosaic  
 Organic Matte  
 8510-0031-0

## IMAGE VARIATIONS

This collection has a wide variety of facings by size to maximize the realism it can convey within a design space.

48 x 48 in / 120 x 120 cm  
 20 images

36 x 36 in / 90 x 90 cm  
 40 images

24 x 48 in / 60 x 120 cm  
 40 images

24 x 24 in / 60 x 60 cm  
 60 images

12 x 24 in / 30 x 60 cm  
 120 images

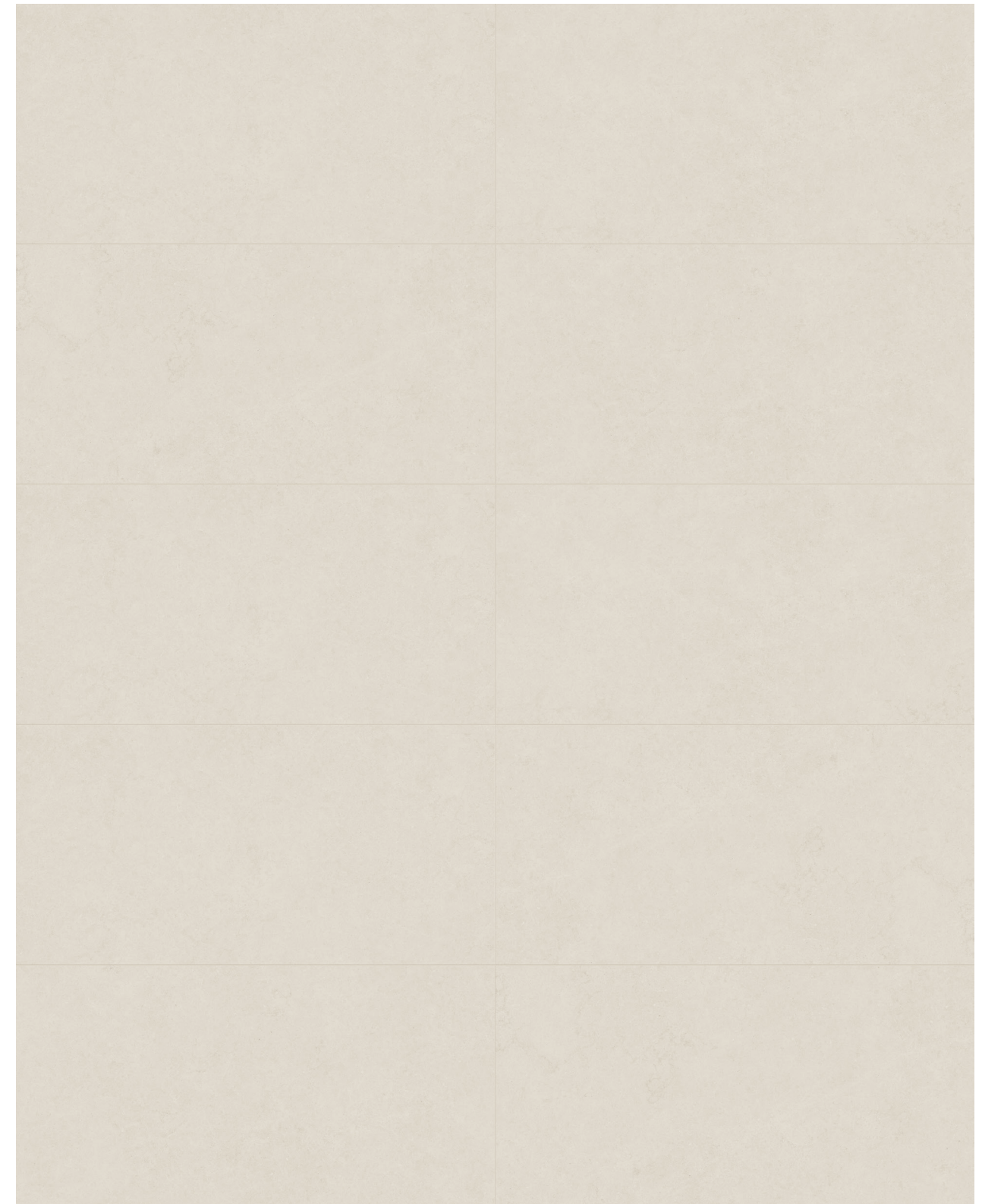

24 x 48 in / 60 x 120 cm Lithoform Crosscut Dunes Rectified Honed / Organic Matte Colorsync Porcelain Tile

# Lithoform Crosscut, *Coast. Slabs.*

Atmospheres that become a sanctuary of serenity.

Des atmosphères propices à la sérénité.  
Atmósferas que se convierten en refugio de serenidad.  
Huzur sığınacağına dönüşen atmosferler.

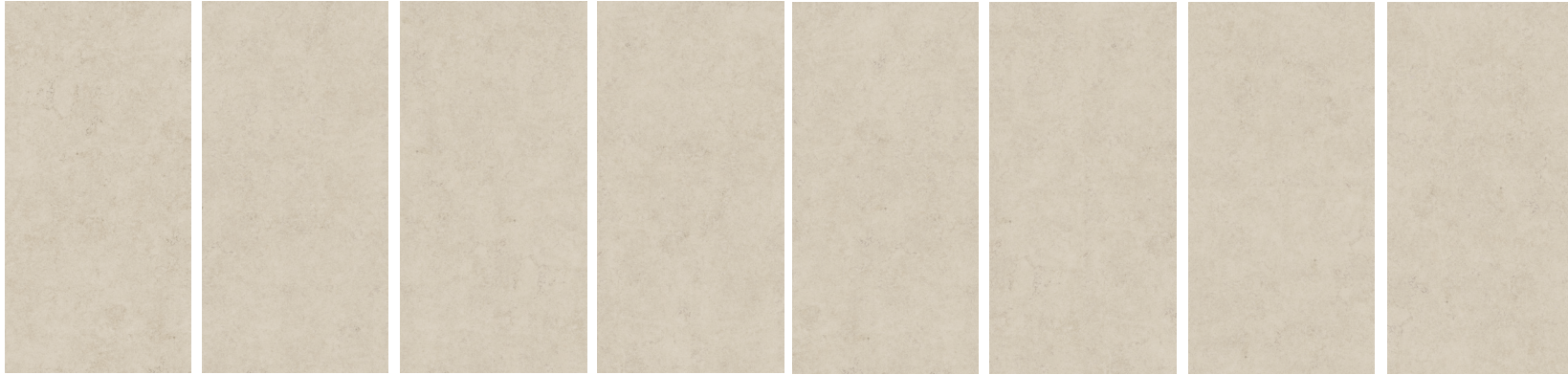

63 x 126 x 0.24 in / 160 x 320 x 0.6 cm  
Rectified Sintered Slab  
Honed 8000-0545-1  
Organic Matte 8000-0547-1

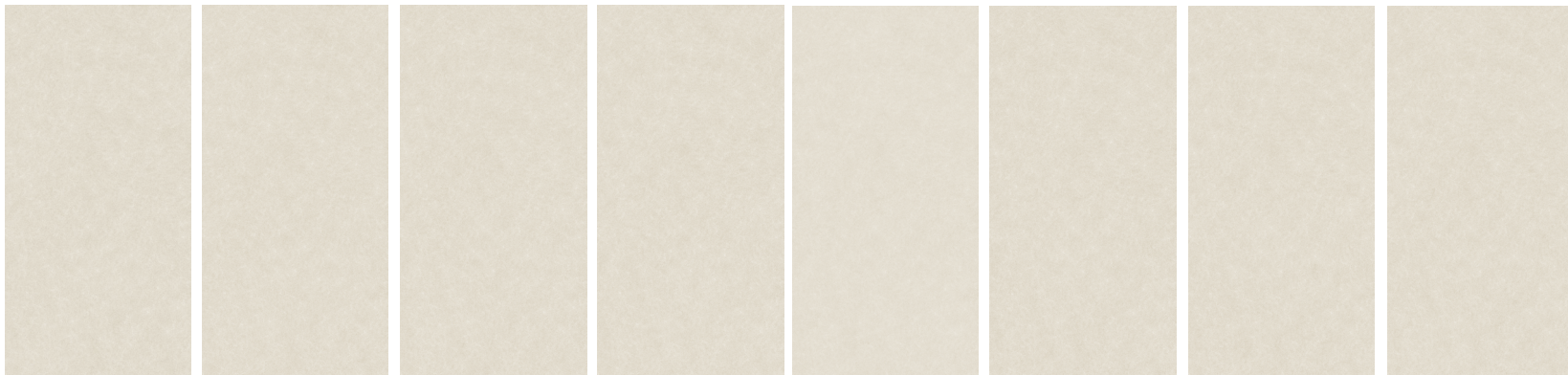

63 x 126 x 0.24 in / 160 x 320 x 0.6 cm  
Rectified Sintered Slab  
Vintage\* 8000-0546-0



VINTAGE FINISH\*

Advanced glazing and visual alterations give vintage texture depth and an authentically aged appearance.

## IMAGE VARIATIONS

This collection has a wide variety of facings by size to maximize the realism it can convey within a design space.

63 x 126 in / 160 x 320 cm Sintered Slab 8 images  
48 x 110 in / 120 x 280 cm Porcelain Slab 10 images

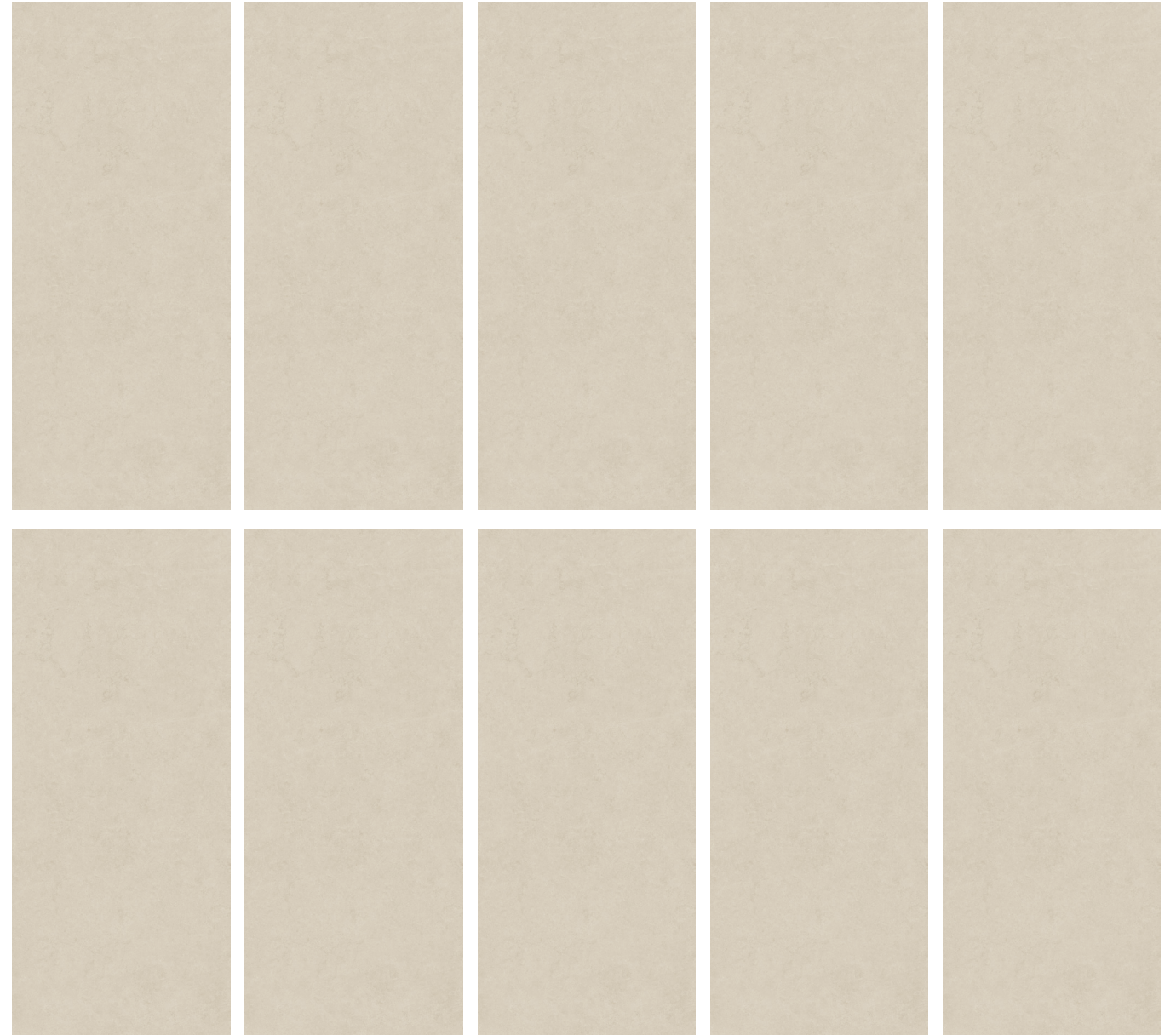

48 x 110 x 0.24 in / 120 x 280 x 0.6 cm  
Rectified Porcelain Slab  
Honed 8500-0083-0  
Organic Matte 8500-0084-0



SLAB DESIGN TYPE: Random

# Lithoform Crosscut, *Coast. Tiles, Pavers, and Mosaics.*

Atmospheres that become a sanctuary of serenity.

Des atmosphères propices à la sérénité.  
 Atmósferas que se convierten en refugio de serenidad.  
 Huzur sığınacağına dönüşen atmosferler.

## IMAGE VARIATIONS

This collection has a wide variety of facings by size to maximize the realism it can convey within a design space.

48 x 48 in / 120 x 120 cm  
20 images

36 x 36 in / 90 x 90 cm  
40 images

24 x 48 in / 60 x 120 cm  
40 images

24 x 24 in / 60 x 60 cm  
60 images

12 x 24 in / 30 x 60 cm  
120 images



48 x 48 in / 120 x 120 cm  
Rectified  
Honed 8500-0173-0  
Organic Matte 8500-0174-0



36 x 36 in / 90 x 90 cm  
Rectified  
Honed 8500-0569-0  
Organic Matte 8500-0570-0



### VINTAGE FINISH\*

Advanced glazing and visual alterations give vintage texture depth and an authentically aged appearance.



36 x 36 in / 90 x 90 cm  
Rectified Paver  
Vintage\* 8500-0660-0



24 x 48 in / 60 x 120 cm  
Rectified  
Honed 8500-0459-0  
Organic Matte 8500-0460-0

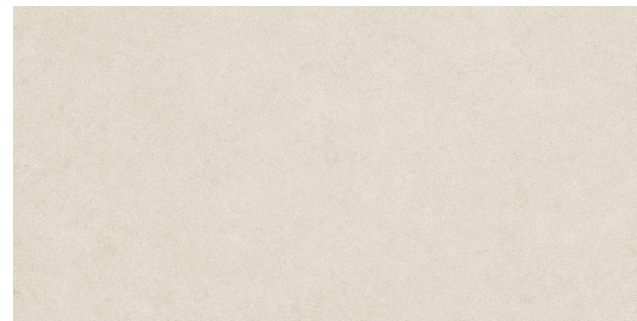

24 x 48 in / 60 x 120 cm  
Rectified  
Vintage\* 8500-0461-0  
2 cm Rectified Paver - Vintage\* 8500-0678-0



24 x 24 in / 60 x 60 cm  
Rectified  
Honed 8500-0241-0  
Organic Matte 8500-0242-0



24 x 24 in / 60 x 60 cm  
Rectified  
Vintage\* 8500-0243-0



12 x 24 in / 30 x 60 cm  
Rectified  
Honed 8500-0337-0  
Organic Matte 8500-0338-0

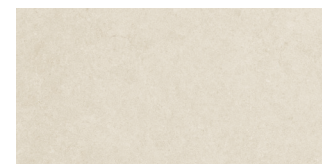

12 x 24 in / 30 x 60 cm  
Rectified  
Vintage\* 8500-0339-0

### Mosaic



4 in / 10 cm  
Hexagon Mosaic  
Organic Matte  
8510-0032-0

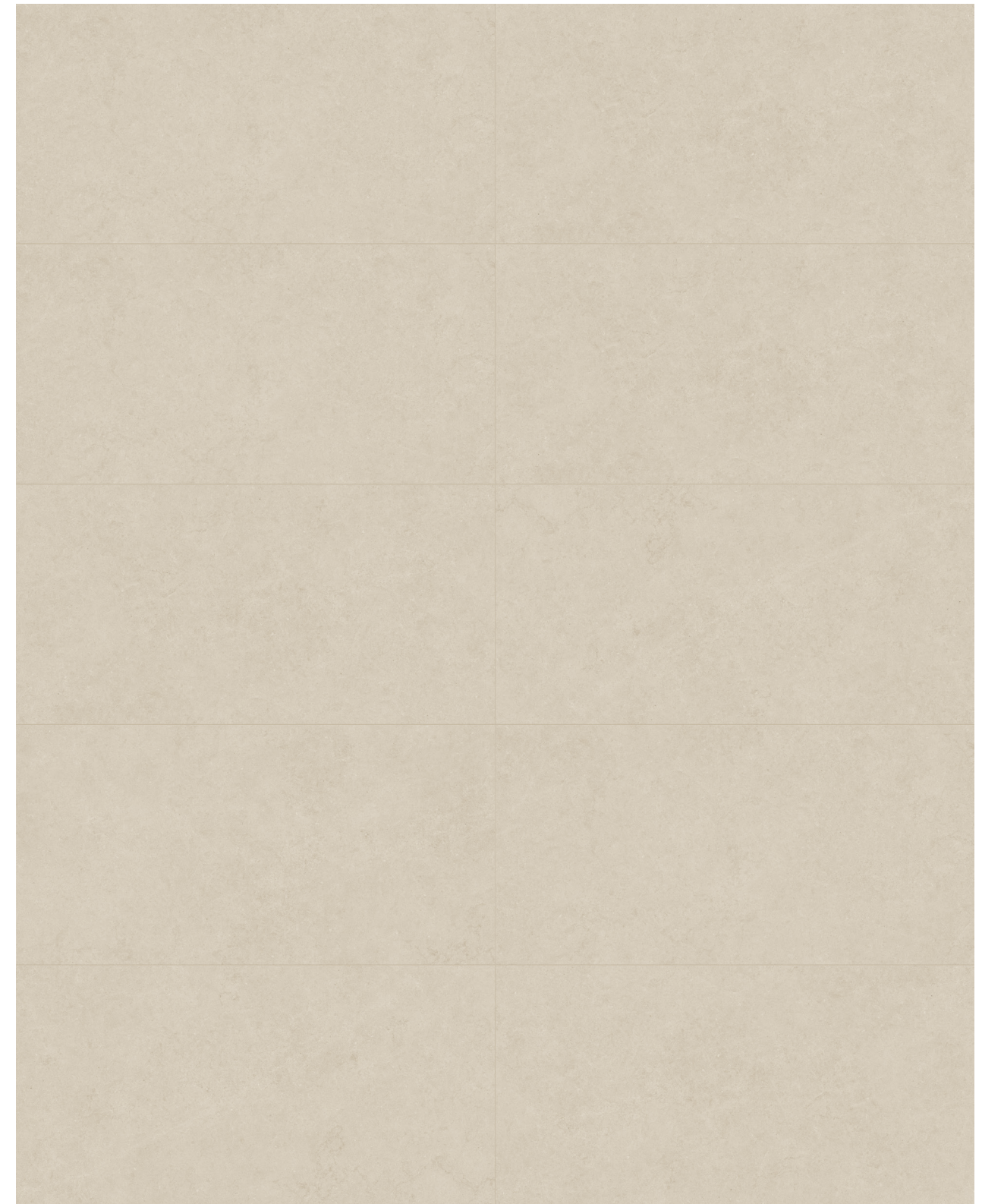

24 x 48 in / 60 x 120 cm Lithoform Crosscut Coast Rectified Honed / Organic Matte Colorsync Porcelain Tile

# Lithoform Crosscut, *Vista. Slabs.*

Calming and elegant, an ashen tone for surfaces of sophistication.

Calme et élégant, un ton cendré pour des surfaces sophistiquées.  
Apacible y elegante, tonalidad ceniza para superficies refinadas.  
Huzur veren, zarif ve sofistike yüzeyler için kül rengi bir ton.

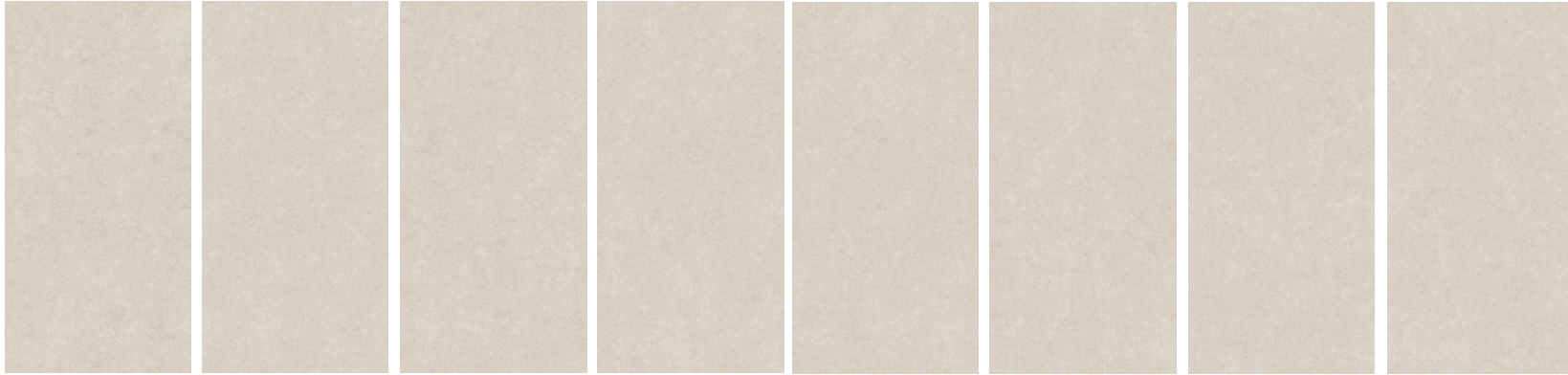

63 x 126 x 0.24 in / 160 x 320 x 0.6 cm  
Rectified Sintered Slab  
Honed 8000-0551-1  
Organic Matte 8000-0553-1

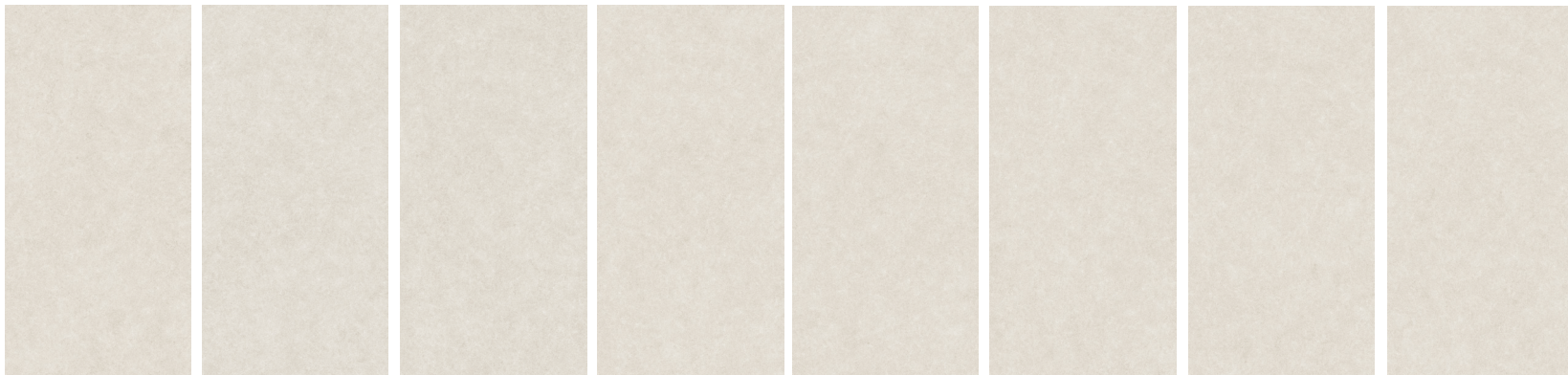

63 x 126 x 0.24 in / 160 x 320 x 0.6 cm  
Rectified Sintered Slab  
Vintage\* 8000-0552-0



### VINTAGE FINISH\*

Advanced glazing and visual alterations give vintage texture depth and an authentically aged appearance.

### IMAGE VARIATIONS

This collection has a wide variety of facings by size to maximize the realism it can convey within a design space.

63 x 126 in / 160 x 320 cm Sintered Slab 8 images  
48 x 110 in / 120 x 280 cm Porcelain Slab 10 images

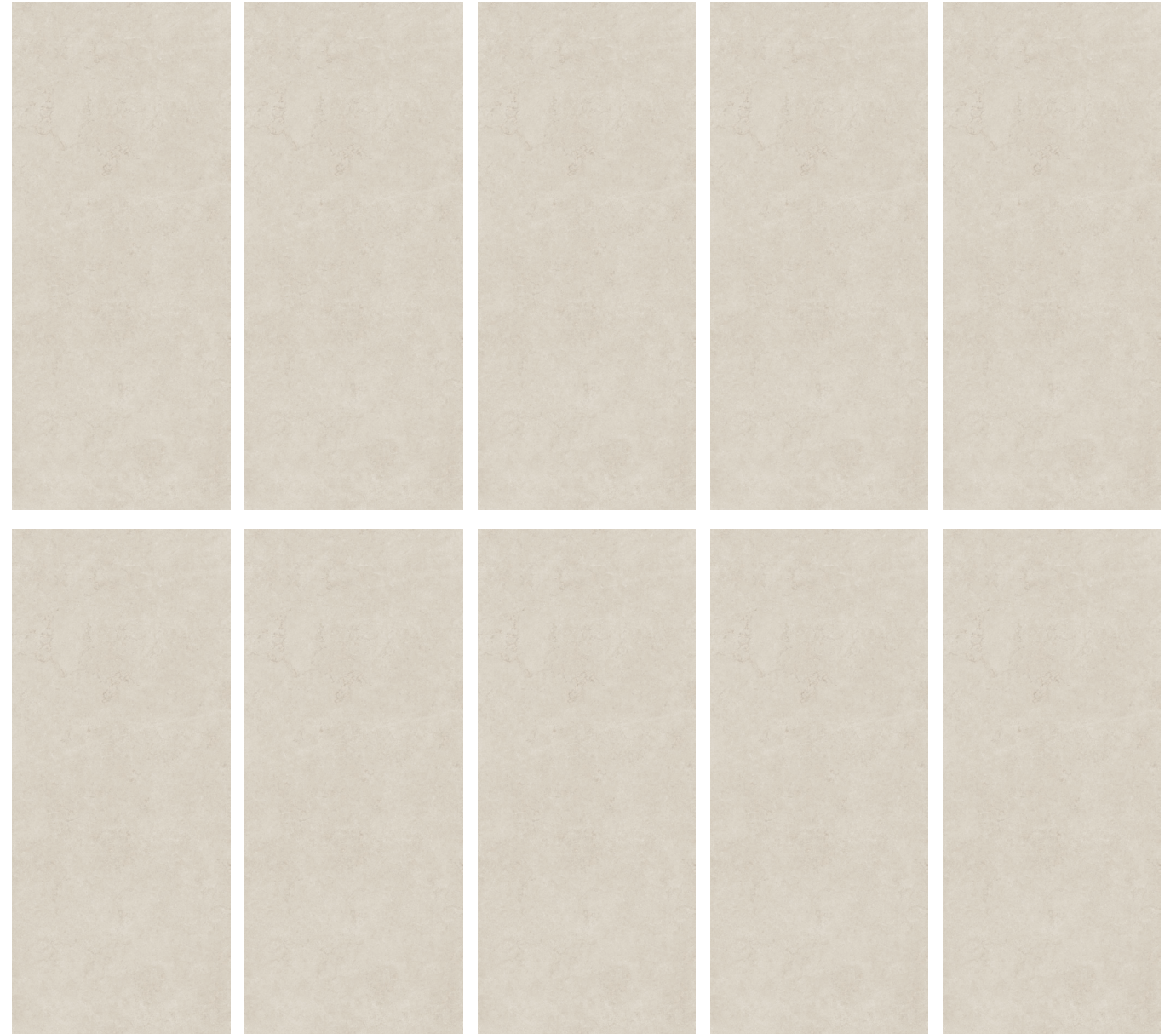

48 x 110 x 0.24 in / 120 x 280 x 0.6 cm  
Rectified Porcelain Slab  
Honed 8500-0086-0  
Organic Matte 8500-0087-0



SLAB DESIGN TYPE: Random

# Lithoform Crosscut, *Vista. Tiles, Pavers, and Mosaics.*

Calming and elegant, an ashen tone for surfaces of sophistication.

Calme et élégant, un ton cendré pour des surfaces sophistiquées.  
 Apacible y elegante, tonalidad ceniza para superficies refinadas.  
 Huzur veren, zarif ve sofistike yüzeyler için kül rengi bir ton.



48 x 48 in / 120 x 120 cm  
 Rectified  
 Honed 8500-0176-0  
 Organic Matte 8500-0177-0



36 x 36 in / 90 x 90 cm  
 Rectified  
 Honed 8500-0575-0  
 Organic Matte 8500-0576-0

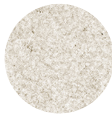

### VINTAGE FINISH\*

Advanced glazing and visual alterations give vintage texture depth and an authentically aged appearance.



36 x 36 in / 90 x 90 cm  
 Rectified Paver  
 Vintage\* 8500-0661-0



24 x 48 in / 60 x 120 cm  
 Rectified  
 Honed 8500-0477-0  
 Organic Matte 8500-0478-0

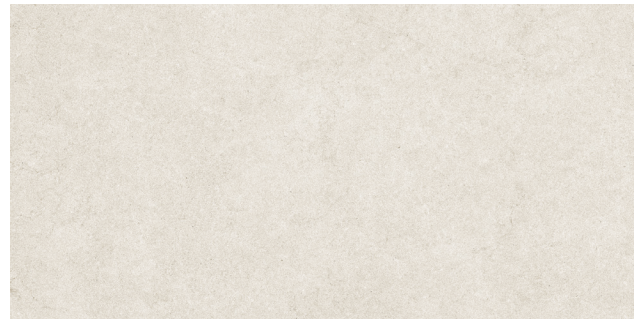

24 x 48 in / 60 x 120 cm  
 Rectified  
 Vintage\* 8500-0479-0  
 2 cm Rectified Paver - Vintage\* 8500-0679-0



24 x 24 in / 60 x 60 cm  
 Rectified  
 Honed 8500-0250-0  
 Organic Matte 8500-0251-0



24 x 24 in / 60 x 60 cm  
 Rectified  
 Vintage\* 8500-0252-0

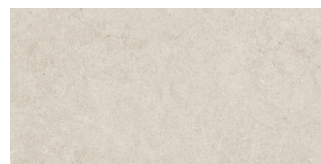

12 x 24 in / 30 x 60 cm  
 Rectified  
 Honed 8500-0355-0  
 Organic Matte 8500-0356-0

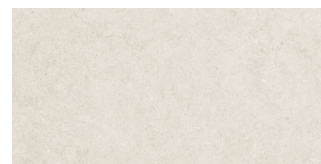

12 x 24 in / 30 x 60 cm  
 Rectified  
 Vintage\* 8500-0357-0

### Mosaic



4 in / 10 cm  
 Hexagon Mosaic  
 Organic Matte  
 8510-0033-0

### IMAGE VARIATIONS

This collection has a wide variety of facings by size to maximize the realism it can convey within a design space.

48 x 48 in / 120 x 120 cm  
 20 images

36 x 36 in / 90 x 90 cm  
 40 images

24 x 48 in / 60 x 120 cm  
 40 images

24 x 24 in / 60 x 60 cm  
 60 images

12 x 24 in / 30 x 60 cm  
 120 images

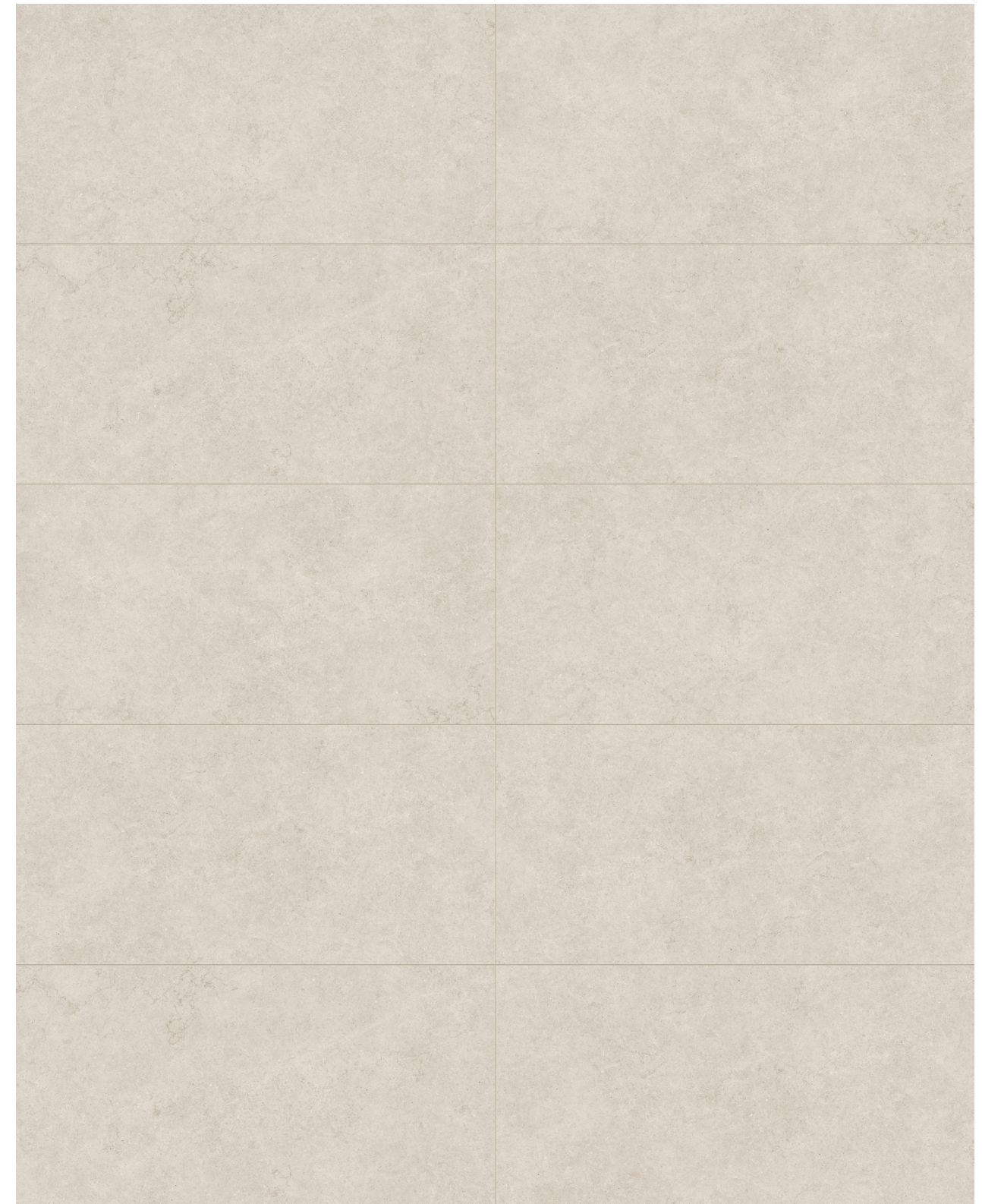

24 x 48 in / 60 x 120 cm Lithoform Crosscut Vista Rectified Honed / Organic Matte Colorsync Porcelain Tile

# Lithoform Crosscut, *Twilight. Slabs.*

Enhances interiors with timeless elegance.

Rehausse les intérieurs d'une élégance intemporelle.  
Realza los interiores con una elegancia atemporal.  
Zamansız zarafetle iç mekanları güzelleştirir.

## IMAGE VARIATIONS

This collection has a wide variety of facings by size to maximize the realism it can convey within a design space.

48 x 110 in / 120 x 280 cm Porcelain Slab  
10 images

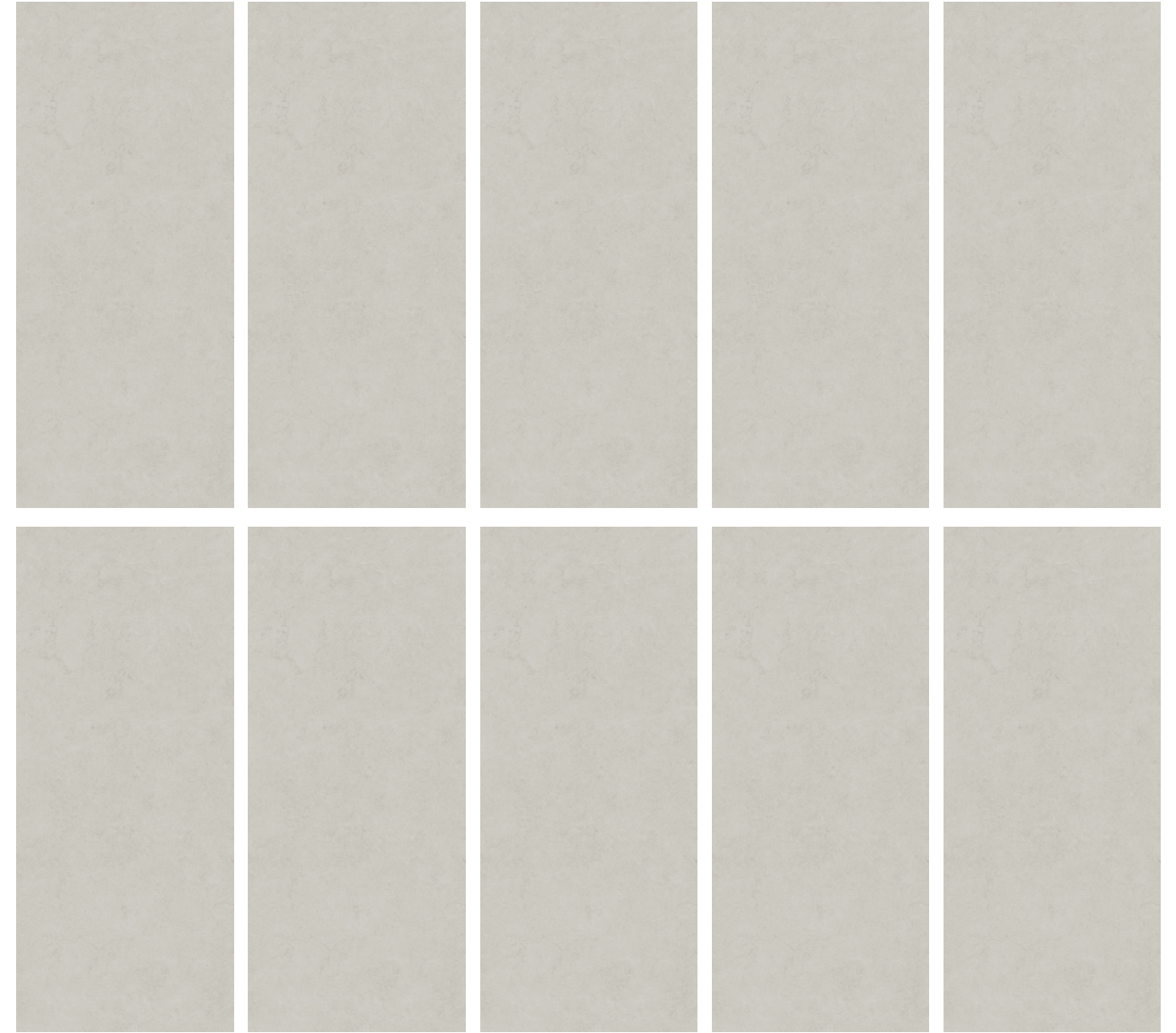

48 x 110 x 0.24 in / 120 x 280 x 0.6 cm   
Rectified Porcelain Slab  
Honed 8500-0089-0  
Organic Matte 8500-0090-0

SLAB DESIGN TYPE:  Random

# Lithoform Crosscut, *Twilight. Tiles, Pavers, and Mosaics.*

Enhances interiors with timeless elegance.

Rehausse les intérieurs d'une élégance intemporelle.  
Realza los interiores con una elegancia atemporal.  
Zamansız zarafetle iç mekanları güzelleştirir.



48 x 48 in / 120 x 120 cm  
Rectified  
Honed 8500-0179-0  
Organic Matte 8500-0180-0



36 x 36 in / 90 x 90 cm  
Rectified  
Honed 8500-0573-0  
Organic Matte 8500-0574-0



VINTAGE FINISH\*

Advanced glazing and visual alterations give vintage texture depth and an authentically aged appearance.



36 x 36 in / 90 x 90 cm  
Rectified Paver  
Vintage\* 8500-0662-0



24 x 48 in / 60 x 120 cm  
Rectified  
Honed 8500-0471-0  
Organic Matte 8500-0472-0



24 x 48 in / 60 x 120 cm  
Rectified  
Vintage\* 8500-0473-0  
2 cm Rectified Paver - Vintage\* 8500-0680-0



24 x 24 in / 60 x 60 cm  
Rectified  
Honed 8500-0247-0  
Organic Matte 8500-0248-0



24 x 24 in / 60 x 60 cm  
Rectified  
Vintage\* 8500-0249-0

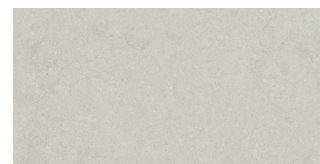

12 x 24 in / 30 x 60 cm  
Rectified  
Honed 8500-0349-0  
Organic Matte 8500-0350-0

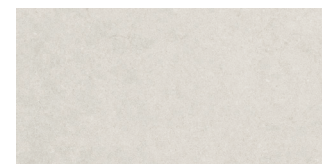

12 x 24 in / 30 x 60 cm  
Rectified  
Vintage\* 8500-0351-0

## Mosaic



4 in / 10 cm  
Hexagon Mosaic  
Organic Matte  
8510-0034-0

## IMAGE VARIATIONS

This collection has a wide variety of facings by size to maximize the realism it can convey within a design space.

48 x 48 in / 120 x 120 cm  
20 images

36 x 36 in / 90 x 90 cm  
40 images

24 x 48 in / 60 x 120 cm  
40 images

24 x 24 in / 60 x 60 cm  
60 images

12 x 24 in / 30 x 60 cm  
120 images



24 x 48 in / 60 x 120 cm Lithoform Crosscut Twilight Rectified Honed / Organic Matte Colorsync Porcelain Tile

# Lithoform Veincut, *Dunes. Slabs.*

A testament to a soft aesthetic.

Un témoignage à l'esthétique feutrée.  
Testimonio de una estética suave.  
Hassas bir estetiğin ifadesi.

## IMAGE VARIATIONS

This collection has a wide variety of facings by size to maximize the realism it can convey within a design space.

63 x 126 in / 160 x 320 cm Sintered Slab  
6 images

48 x 110 in / 120 x 280 cm Porcelain Slab  
8 images



63 x 126 x 0.24 in / 160 x 320 x 0.6 cm  
Rectified Sintered Slab  
Honed 8000-0556-1  
Organic Matte 8000-0557-1

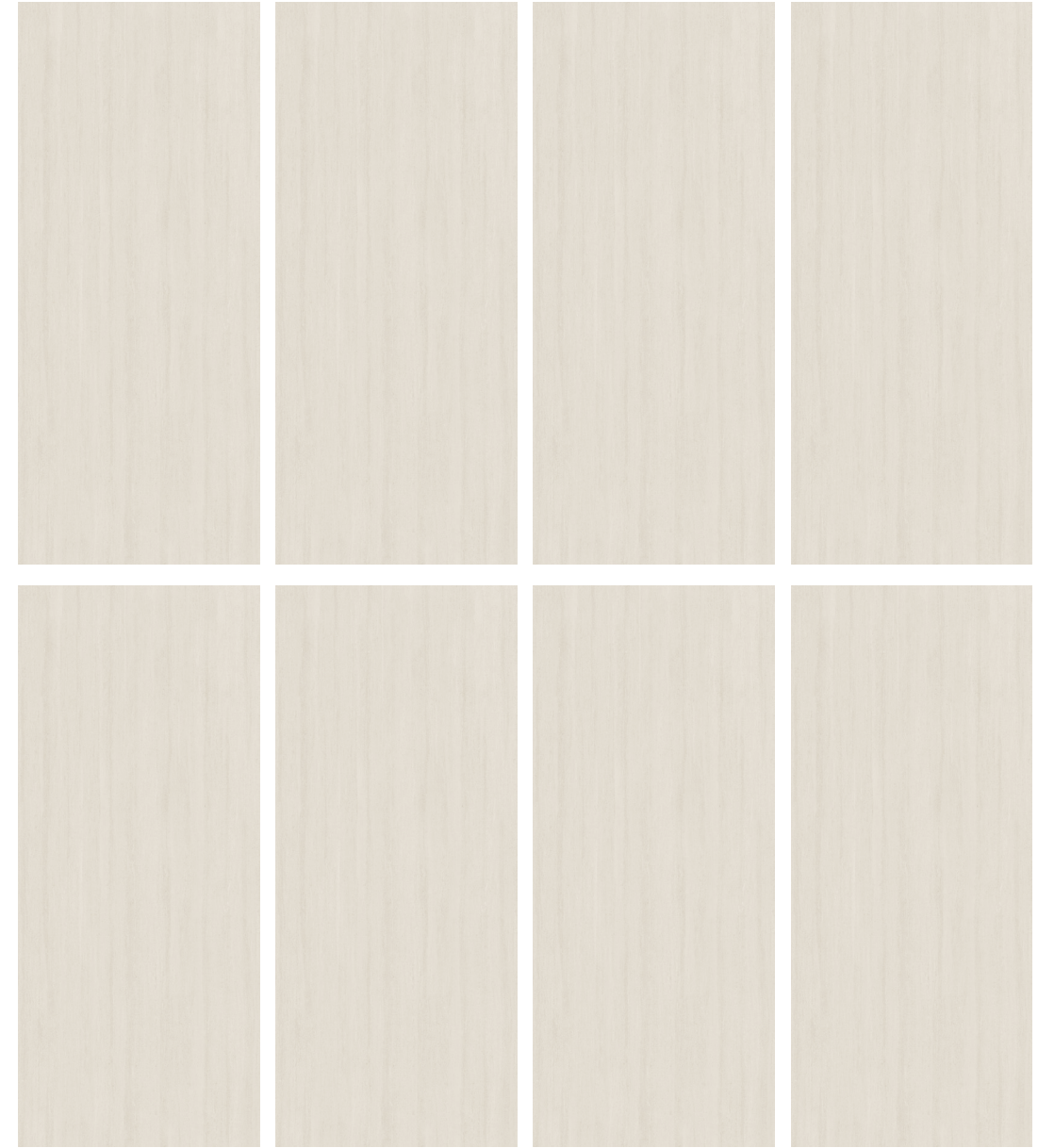

48 x 110 x 0.24 in / 120 x 280 x 0.6 cm  
Rectified Porcelain Slab  
Honed 8500-0092-0  
Organic Matte 8500-0093-0



SLAB DESIGN TYPE: Random

# Lithoform Veincut, *Dunes*. Tiles, Pavers, and Mosaics.

A testament to a soft aesthetic.

Un témoignage à l'esthétique feutrée.  
 Testimonio de una estética suave.  
 Hassas bir estetiğin ifadesi.



36 x 72 in / 90 x 180 cm  
 Rectified  
 Honed 8500-0612-0  
 Organic Matte 8500-0613-0



36 x 72 in / 90 x 180 cm  
 Rectified  
 Vintage\* 8500-0614-0



12 x 24 in / 30 x 60 cm  
 Rectified  
 Honed 8500-0346-0  
 Organic Matte 8500-0347-0



12 x 24 in / 30 x 60 cm  
 Rectified  
 Vintage\* 8500-0348-0

## Mosaic



2 in / 5 cm  
 Hexagon Mosaic  
 Organic Matte 8510-0035-0



24 x 48 in / 60 x 120 cm  
 Rectified  
 Honed 8500-0468-0  
 Organic Matte 8500-0469-0

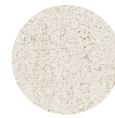

### VINTAGE FINISH\*

Advanced glazing and visual alterations give vintage texture depth and an authentically aged appearance.



24 x 48 in / 60 x 120 cm  
 Rectified  
 Vintage\* 8500-0470-0  
 2 cm Rectified Paver - Vintage\* 8500-0681-0

### IMAGE VARIATIONS

This collection has a wide variety of facings by size to maximize the realism it can convey within a design space.

36 x 72 / 90 x 180  
 20 images

24 x 48 in / 60 x 120 cm  
 40 images

12 x 24 in / 30 x 60 cm  
 120 images



24 x 48 in / 60 x 120 cm Lithoform Veincut Dunes Rectified Honed / Organic Matte Colorsync Porcelain Tile

# Lithoform Veincut, *Coast. Slabs.*

Delicate veins like linear watercolors.

Des veines délicates comme des aquarelles linéaires.  
Vetas delicadas que parecen delineadas con acuarela.  
Suluboya çizgilerini andiran ince damarlar.

## IMAGE VARIATIONS

This collection has a wide variety of facings by size to maximize the realism it can convey within a design space.

63 x 126 in / 160 x 320 cm Sintered Slab  
6 images

48 x 110 in / 120 x 280 cm Porcelain Slab  
8 images



63 x 126 x 0.24 in / 160 x 320 x 0.6 cm  
Rectified Sintered Slab  
Honed 8000-0554-1  
Organic Matte 8000-0555-1

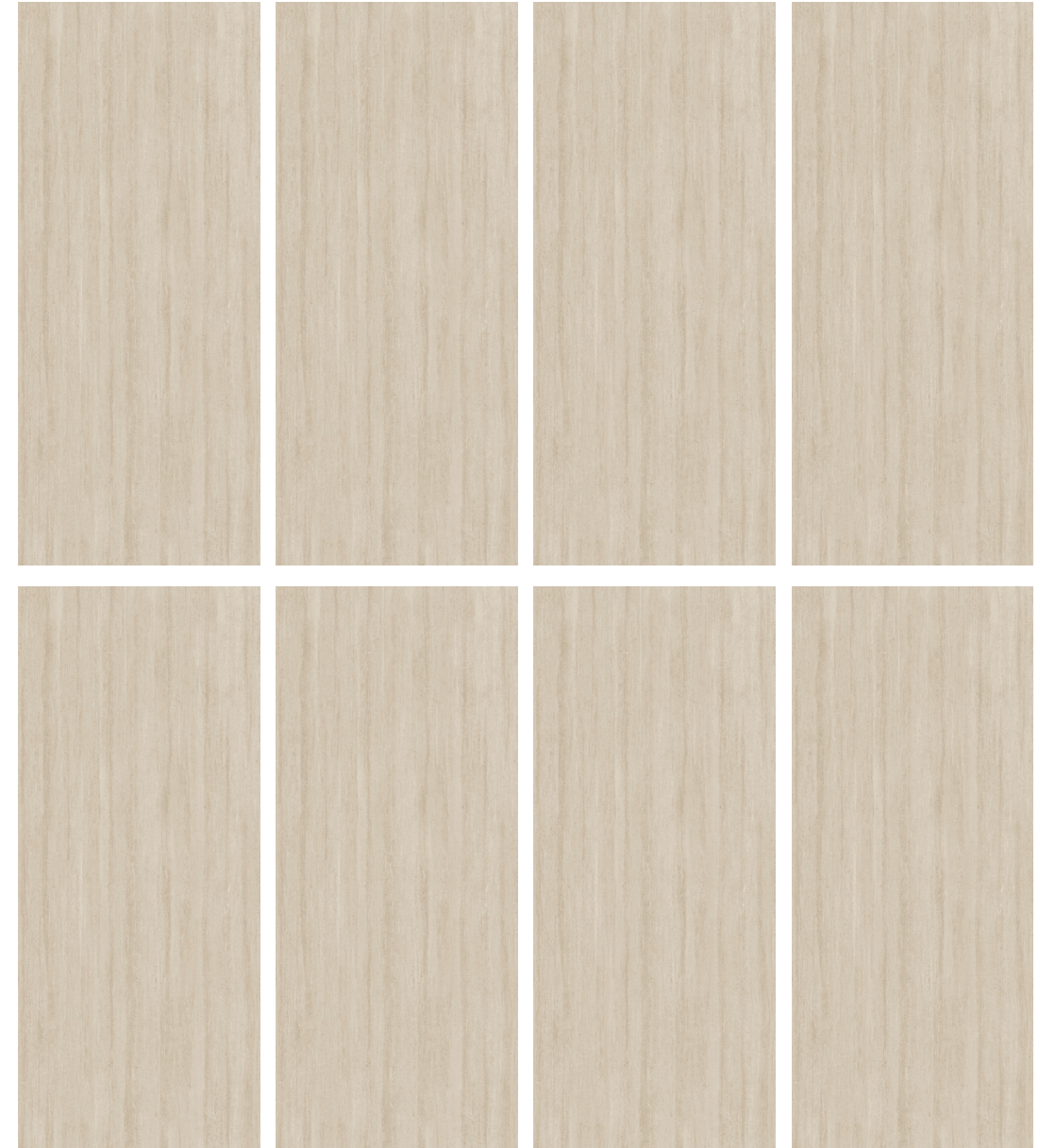

48 x 110 x 0.24 in / 120 x 280 x 0.6 cm  
Rectified Porcelain Slab  
Honed 8500-0095-0  
Organic Matte 8500-0096-0



SLAB DESIGN TYPE: Random

# Lithoform Veincut, *Coast. Tiles, Pavers, and Mosaics.*

Delicate veins like linear watercolors.

Des veines délicates comme des aquarelles linéaires.  
 Vetas delicadas que parecen delineadas con acuarela.  
 Suluboya çizgilerini andıran ince damarlar.



36 x 72 in / 90 x 180 cm  
 Rectified  
 Honed 8500-0609-0  
 Organic Matte 8500-0610-0



36 x 72 in / 90 x 180 cm  
 Rectified  
 Vintage\* 8500-0611-0



12 x 24 in / 30 x 60 cm  
 Rectified  
 Honed 8500-0340-0  
 Organic Matte 8500-0341-0



12 x 24 in / 30 x 60 cm  
 Rectified  
 Vintage\* 8500-0342-0

## Mosaic



2 in / 5 cm  
 Hexagon Mosaic  
 Organic Matte 8510-0036-0



24 x 48 in / 60 x 120 cm  
 Rectified  
 Honed 8500-0462-0  
 Organic Matte 8500-0463-0



### VINTAGE FINISH\*

Advanced glazing and visual alterations give vintage texture depth and an authentically aged appearance.



24 x 48 in / 60 x 120 cm  
 Rectified  
 Vintage\* 8500-0464-0  
 2 cm Rectified Paver - Vintage\* 8500-0682-0

### IMAGE VARIATIONS

This collection has a wide variety of facings by size to maximize the realism it can convey within a design space.

36 x 72 / 90 x 180  
 20 images

24 x 48 in / 60 x 120 cm  
 40 images

12 x 24 in / 30 x 60 cm  
 120 images

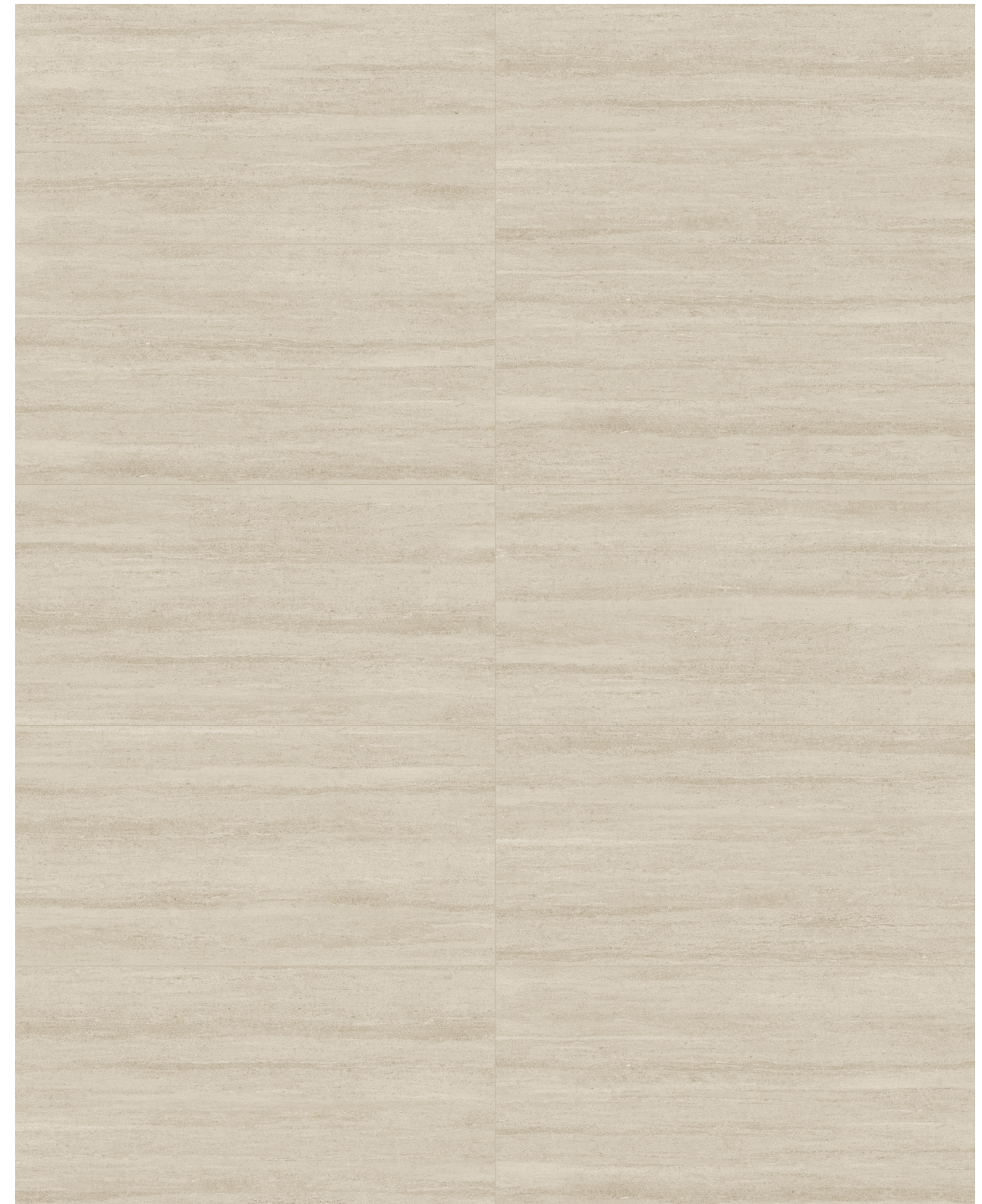

24 x 48 in / 60 x 120 cm Lithoform Veincut Coast Rectified Honed / Organic Matte Colorsync Porcelain Tile

# Lithoform Veincut, *Vista. Slabs.*

The expressive power of grey limestone.

La puissance expressive de la pierre calcaire grise.  
La fuerza expresiva de la piedra caliza gris.  
Gri renkli kireç taşının etkileyici gücü.



63 x 126 x 0.24 in / 160 x 320 x 0.6 cm  
Rectified Sintered Slab  
Honed 8000-0558-1  
Organic Matte 8000-0559-1



## IMAGE VARIATIONS

This collection has a wide variety of facings by size to maximize the realism it can convey within a design space.

63 x 126 in / 160 x 320 cm Sintered Slab  
6 images

48 x 110 in / 120 x 280 cm Porcelain Slab  
8 images

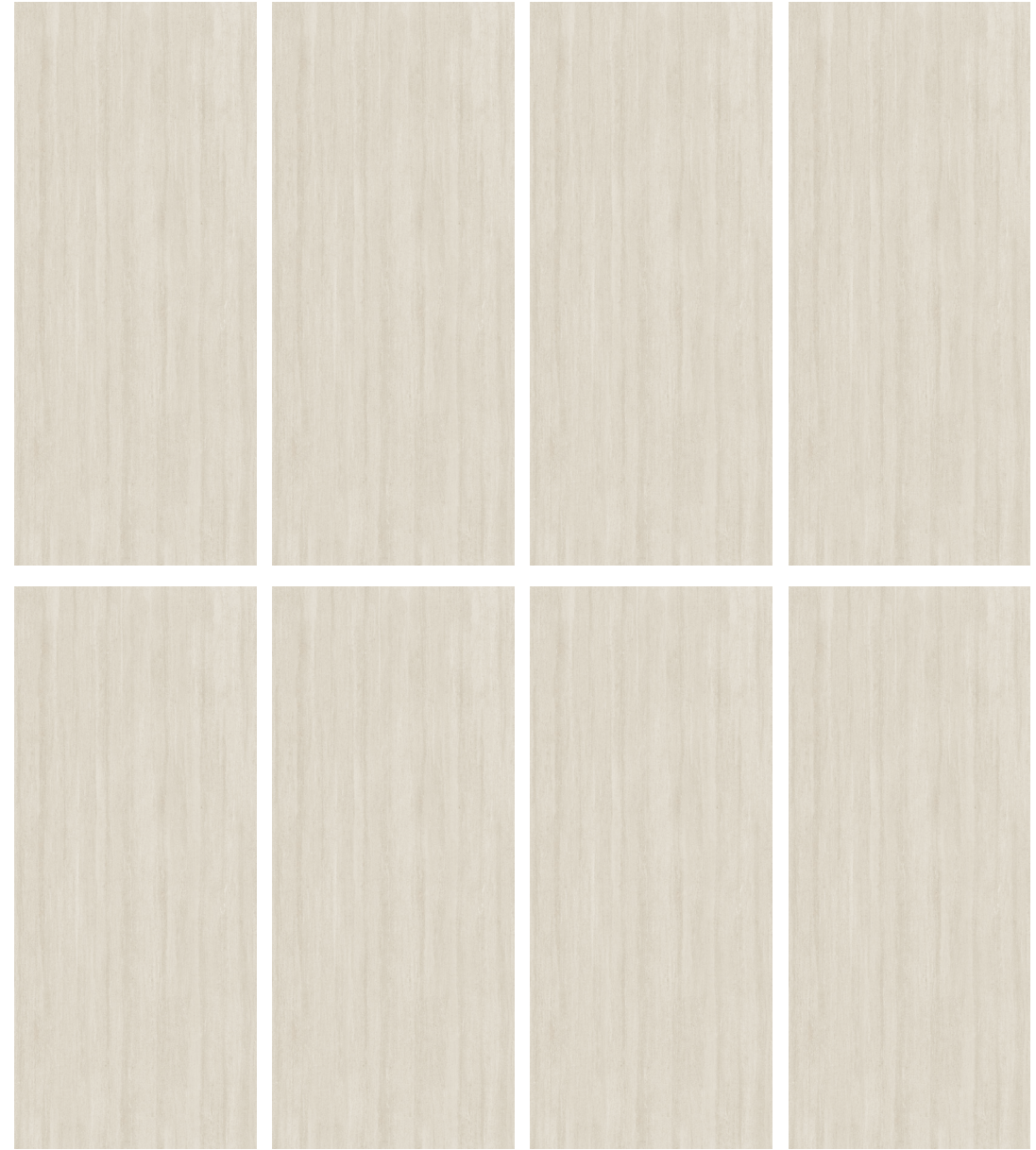

48 x 110 x 0.24 in / 120 x 280 x 0.6 cm  
Rectified Porcelain Slab  
Honed 8500-0098-0  
Organic Matte 8500-0099-0



SLAB DESIGN TYPE: Random

# Lithoform Veincut, Vista. Tiles, Pavers, and Mosaics.

The expressive power of grey limestone.

La puissance expressive de la pierre calcaire grise.  
 La fuerza expresiva de la piedra caliza gris.  
 Gri renkli kireç taşının etkileyici gücü.



36 x 72 in / 90 x 180 cm  
 Rectified  
 Honed 8500-0618-0  
 Organic Matte 8500-0619-0



24 x 48 in / 60 x 120 cm  
 Rectified  
 Honed 8500-0480-0  
 Organic Matte 8500-0481-0



36 x 72 in / 90 x 180 cm  
 Rectified  
 Vintage\* 8500-0620-0

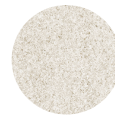

### VINTAGE FINISH\*

Advanced glazing and visual alterations give vintage texture depth and an authentically aged appearance.



24 x 48 in / 60 x 120 cm  
 Rectified  
 Vintage\* 8500-0482-0  
 2 cm Rectified Paver - Vintage\* 8500-0683-0



12 x 24 in / 30 x 60 cm  
 Rectified  
 Honed 8500-0358-0  
 Organic Matte 8500-0359-0



12 x 24 in / 30 x 60 cm  
 Rectified  
 Vintage\* 8500-0360-0

### Mosaic

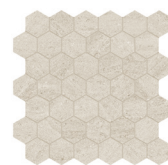

2 in / 5 cm  
 Hexagon Mosaic  
 Organic Matte 8510-0037-0

### IMAGE VARIATIONS

This collection has a wide variety of facings by size to maximize the realism it can convey within a design space.

36 x 72 / 90 x 180  
 20 images

24 x 48 in / 60 x 120 cm  
 40 images

12 x 24 in / 30 x 60 cm  
 120 images

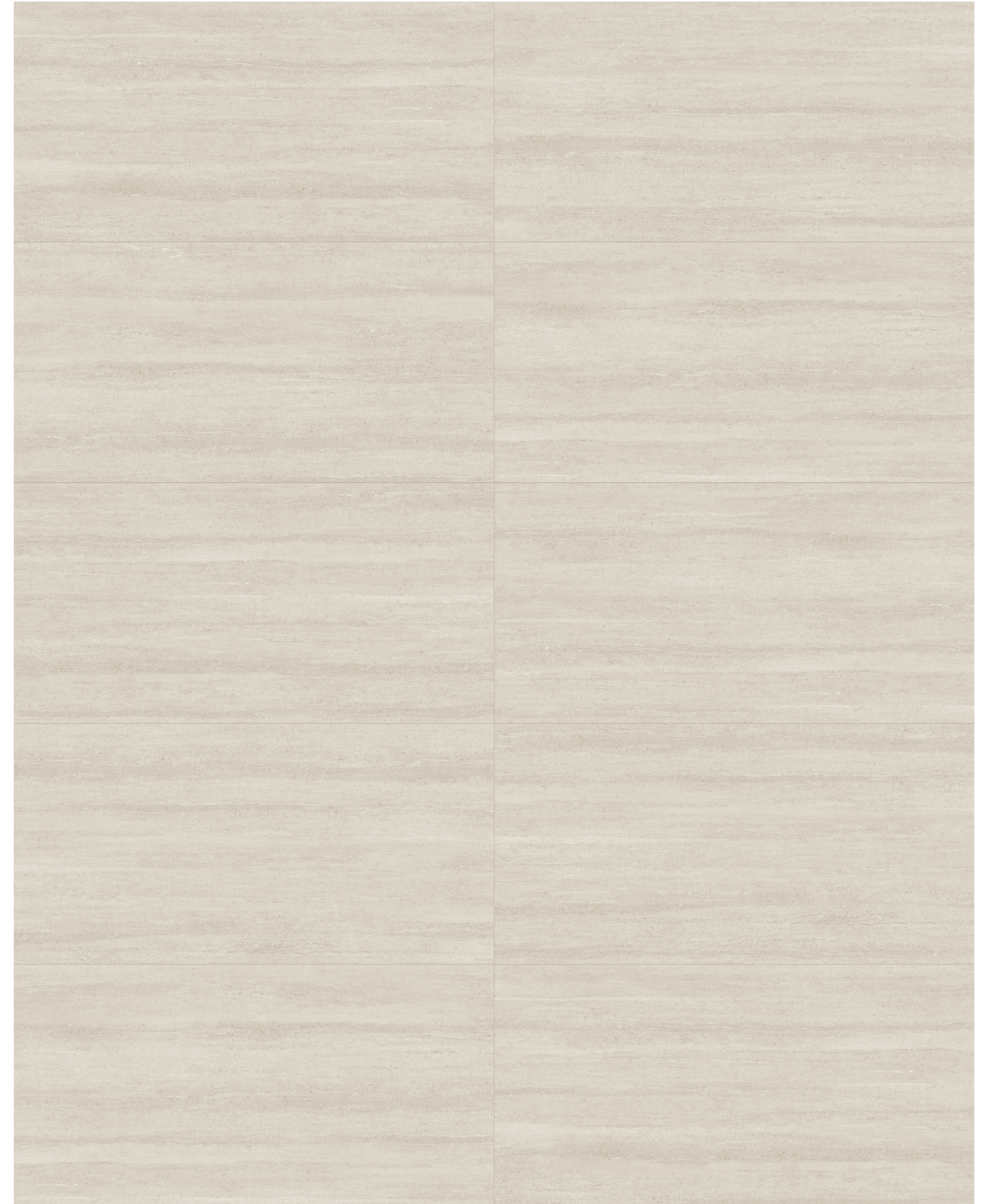

24 x 48 in / 60 x 120 cm Lithoform Veincut Vista Rectified Honed / Organic Matte Colorsync Porcelain Tile



# Lithoform Veincut, *Twilight. Slabs.*

Refined texture transforms your design vision.

Une texture raffinée qui transforme votre vision du design.  
Su textura refinada transforma su visión del diseño.  
Rafine dokular, tasarım vizyonunuza yön verir.

## IMAGE VARIATIONS

This collection has a wide variety of facings by size to maximize the realism it can convey within a design space.

48 x 110 in / 120 x 280 cm Porcelain Slab  
8 images

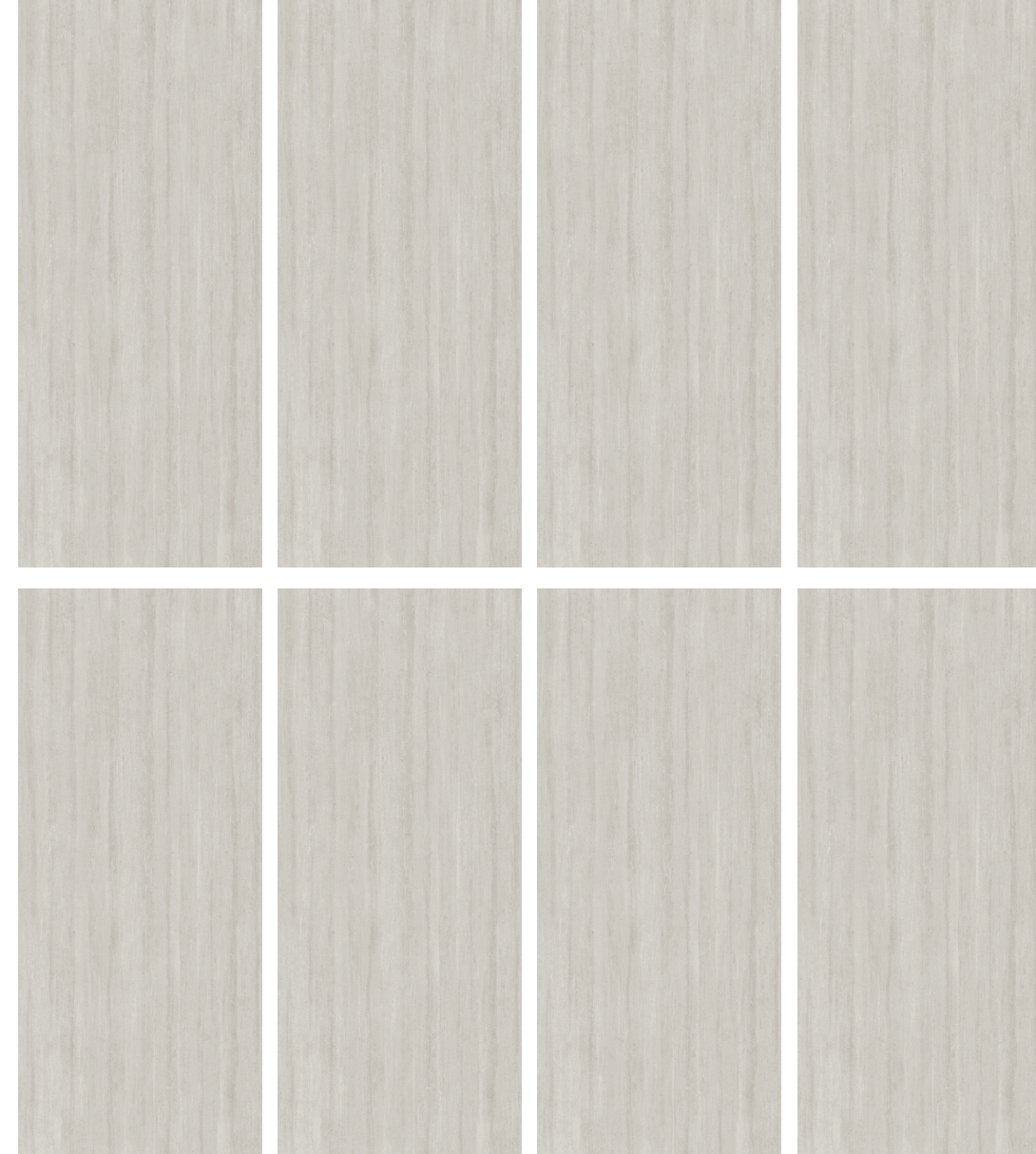

48 x 110 x 0.24 in / 120 x 280 x 0.6 cm  
Rectified Porcelain Slab  
Honed 8500-0101-0  
Organic Matte 8500-0102-0



SLAB DESIGN TYPE:  Random

# Lithoform Veincut, *Twilight. Tiles, Pavers, and Mosaics.*

Refined texture transforms your design vision.

Une texture raffinée qui transforme votre vision du design.  
 Su textura refinada transforma su visión del diseño.  
 Rafine dokular, tasarım vizyonunuza yön verir.



36 x 72 in / 90 x 180 cm  
 Rectified  
 Honed 8500-0615-0  
 Organic Matte 8500-0616-0



24 x 48 in / 60 x 120 cm  
 Rectified  
 Honed 8500-0474-0  
 Organic Matte 8500-0475-0



36 x 72 in / 90 x 180 cm  
 Rectified  
 Vintage\* 8500-0617-0

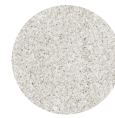

### VINTAGE FINISH\*

Advanced glazing and visual alterations give vintage texture depth and an authentically aged appearance.



24 x 48 in / 60 x 120 cm  
 Rectified  
 Vintage\* 8500-0476-0  
 2 cm Rectified Paver - Vintage\* 8500-0684-0



12 x 24 in / 30 x 60 cm  
 Rectified  
 Honed 8500-0352-0  
 Organic Matte 8500-0353-0



12 x 24 in / 30 x 60 cm  
 Rectified  
 Vintage\* 8500-0354-0

### Mosaic

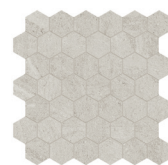

2 in / 5 cm  
 Hexagon Mosaic  
 Organic Matte 8510-0038-0

### IMAGE VARIATIONS

This collection has a wide variety of facings by size to maximize the realism it can convey within a design space.

36 x 72 in / 90 x 180 cm  
 20 images

24 x 48 in / 60 x 120 cm  
 40 images

12 x 24 in / 30 x 60 cm  
 120 images

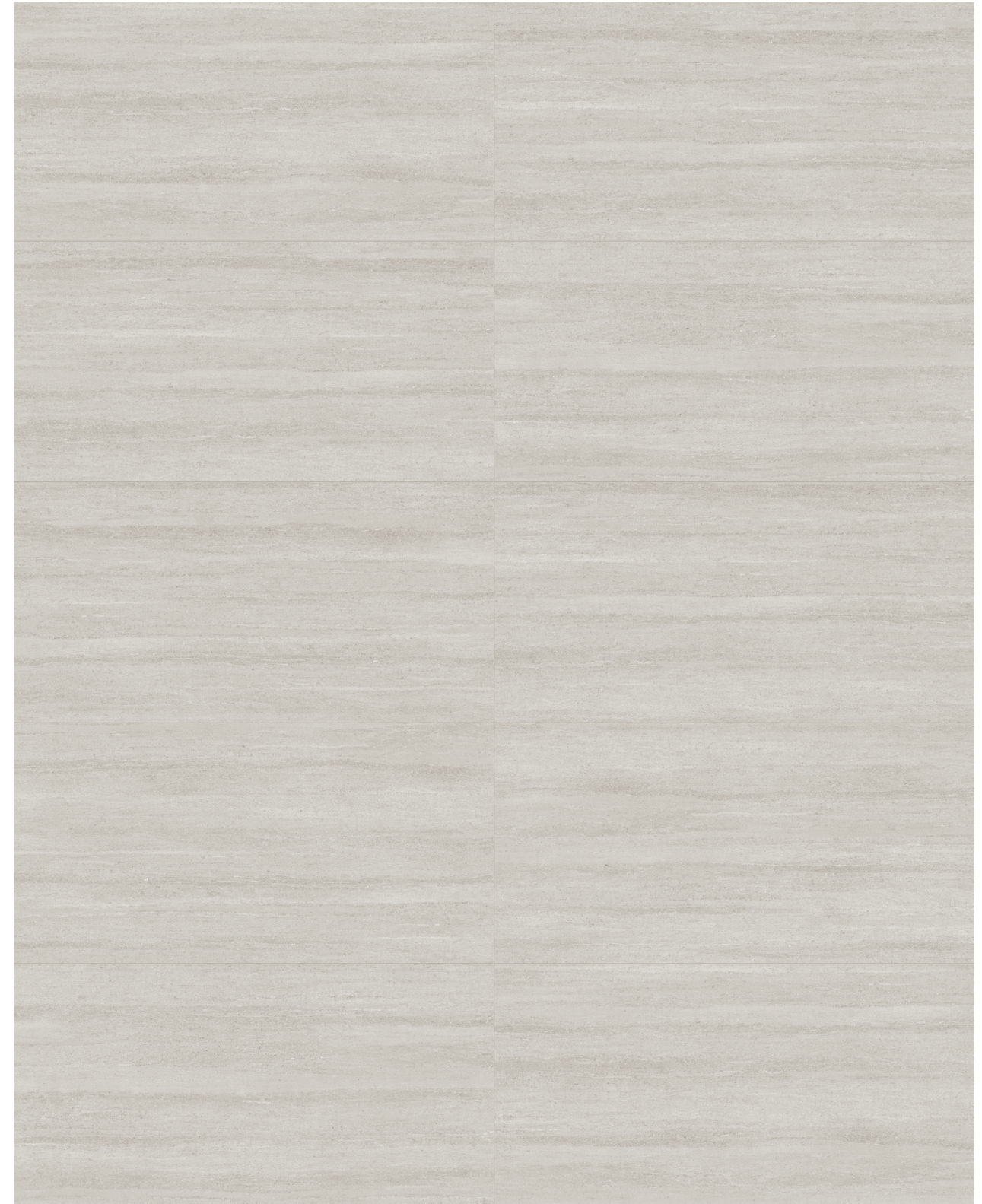

24 x 48 in / 60 x 120 cm Lithoform Veincut Twilight Rectified Honed / Organic Matte Colorsync Porcelain Tile

## THE WORLD OF ANATOLIA

CANADIAN ORIGINS, GLOBAL PERSPECTIVE.

PREMIUM QUALITY, CREATIVE DESIGNS,  
AND PATENTED TECHNOLOGY REPRESENT ANATOLIA'S  
LEADERSHIP IN THE SURFACES INDUSTRY.



<sup>EN</sup> With a deep commitment to excellence, Anatolia stands as a proud Canadian company dedicated to delivering extraordinary products that seamlessly blend modernity, innovation, and sophistication. We are driven by a passion for curating exceptional collections that embody refinement. Through our global network of partnerships, Anatolia offers access to an extensive inventory and unparalleled service, solidifying our position as one of the foremost leaders in the surfaces industry worldwide.

<sup>FR</sup> Avec un engagement profond envers l'excellence, Anatolia est une entreprise canadienne fière de fournir des produits exceptionnels qui allient harmonieusement modernité, innovation et sophistication. Nous sommes animés par la passion de créer des collections exceptionnelles qui incarnent le raffinement. Grâce à notre réseau mondial de partenariats, Anatolia offre l'accès à un vaste inventaire et à un service inégalé, consolidant ainsi notre position parmi les leaders mondiaux de l'industrie des revêtements de surface.

<sup>ES</sup> Con un profundo compromiso con la excelencia, Anatolia se erige como una empresa canadiense orgullosa y dedicada a ofrecer productos extraordinarios que combinan a la perfección modernidad, innovación y sofisticación. Nos impulsa la pasión por crear colecciones excepcionales que encarnan el refinamiento. A través de nuestra red global de socios, Anatolia ofrece acceso a un amplio inventario y un servicio inigualable, lo que consolida nuestra posición como uno de los líderes mundiales en la industria de los revestimientos.

<sup>TR</sup> Mükemmelliğe olan derin bağlılıkla Anatolia, modernliği, yeniliği ve sofistike tasarımı kusursuz bir şekilde harmanlayan olağanüstü ürünler sunmaya kendini adanmış gururlu bir Kanada şirkettir. Biz, zarafeti yansıtan olağanüstü koleksiyonlar oluşturma tutkusuyla hareket ediyoruz. Küresel ortaklık ağıımız sayesinde Anatolia, geniş bir ürün yelpazesine ve eşsiz bir hizmete erişim imkanı sunarak, yüzey endüstrisinde dünya çapında önde gelen liderlerden biri olarak konumunu sağlamlaştırmaktadır.

## DESIGN

CREATIVITY AND SENSITIVITY FOR SHAPES AND MATERIALS,  
TOGETHER WITH PREMIUM QUALITY AND PATENTED TECHNOLOGY.

<sup>EN</sup> Anatolia offers truly exceptional products that embody a carefully preserved heritage and a dynamic engagement with modernity and innovation. Through an endless range of true-to-nature, inspirational designs, Anatolia triggers a dialogue between design spaces and its surfaces, providing an incredible variety of visual stimuli. Colors, shapes, and original motifs trace the outline of Anatolia's DNA, discernible in a series of refined collections, and full of expressions of its intrinsic nature. Every product has been designed in-house by Anatolia's Creative and Product Development Team, led by Cengiz's vision. This is a dynamic and dedicated group that constantly researches new trends and techniques, experimenting with cutting-edge applications of colors and effects on different materials, and developing innovative and original designs.

<sup>FR</sup> Anatolia propose des produits véritablement exceptionnels qui incarnent un héritage soigneusement préservé et un engagement dynamique envers la modernité et l'innovation. Grâce à une gamme infinie de designs inspirés et fidèles à la nature, Anatolia suscite un dialogue entre les espaces design et ses surfaces, offrant une incroyable variété de stimuli visuels. Les couleurs, les formes et les motifs originaux dessinent les contours de l'ADN d'Anatolia, perceptible dans une série de collections raffinées, riches en expressions de sa nature intrinsèque. Chaque produit a été conçu en interne par l'équipe créative et de développement de produits d'Anatolia, sous la direction de Cengiz. Il s'agit d'un groupe dynamique et dévoué qui recherche en permanence de nouvelles tendances et techniques, expérimente des applications de pointe en matière de couleurs et d'effets sur différents matériaux, et développe des designs innovants et originaux.

<sup>ES</sup> Anatolia ofrece productos verdaderamente excepcionales que encarnan un patrimonio cuidadosamente conservado y un compromiso dinámico con la modernidad y la innovación. A través de una gama infinita de diseños inspiradores y fieles a la naturaleza, Anatolia establece un diálogo entre los espacios de diseño y sus superficies, proporcionando una increíble variedad de estímulos visuales. Los colores, las formas y los motivos originales trazan el contorno del ADN de Anatolia, perceptible en una serie de colecciones refinadas y llenas de expresiones de su naturaleza intrínseca. Todos los productos han sido diseñados internamente por el equipo creativo y de desarrollo de productos de Anatolia, dirigido por la visión de Cengiz. Se trata de un grupo dinámico y dedicado que investiga constantemente nuevas tendencias y técnicas, experimentando con aplicaciones de vanguardia de colores y efectos sobre diferentes materiales, y desarrollando diseños innovadores y originales.

<sup>TR</sup> Anatolia, özenle korunan mirasıyla modernlik ve yenilikçiliği dinamik bir uyum içinde buluşturan, gerçekten olağanüstü ürünler sunar. Doğadan ilham alan, özgün tasarımlardan oluşan geniş yelpazesıyla, tasarım alanları ile yüzeyler arasında bir diyalog başlatarak benzersiz bir görsel çeşitlilik yaratır. Renkler, şekiller ve özgün motifler, zarif koleksiyonlarda kendini gösteren ve markanın ruhunu yansıtan Anatolia DNA'sının izlerini taşır. Her ürün, Cengiz Elmaağaçlı'nın vizyonu doğrultusunda Anatolia'nın Yaratıcı ve Ürün Geliştirme Ekibi tarafından şirket içinde tasarlanır. Bu dinamik ve kendini işine adanmış ekip, sürekli olarak yeni trendleri ve teknikleri araştırır, farklı malzemelerde renk ve efektlerin en yeni uygulamalarını dener ve yenilikçi, özgün tasarımlar geliştirir.



## TECHNOLOGY

### THE VISIONARY FORCE BEHIND THE COMPANY'S RISE IN THE REALM OF MANUFACTURING

#### EN CORE VALUES AND GLOBAL PRESENCE

The company holds a prominent position in the global market for surfaces, architectural materials, and design solutions. Continuous innovation, technological research, an international outlook, and social and environmental responsibility are the core values that Anatolia has consistently upheld in its ongoing pursuit of excellence. The Anatolia factory is located in the majestic Gulf of Izmir, Türkiye, encapsulating an innovative design vision that is set to transform the way we think of surfaces. The facility houses the company's research and development department, showrooms, and offices—a major innovation powerhouse with a state-of-the-art manufacturing plant and logistics center.

#### FR VALEURS FONDAMENTALES ET PRÉSENCE MONDIALE

L'entreprise occupe une position de premier plan sur le marché mondial des surfaces, des matériaux architecturaux et des solutions de conception. L'innovation constante, la recherche technologique, une vision internationale ainsi qu'un engagement fort en matière de responsabilité sociale et environnementale sont les valeurs fondamentales qu'Anatolia a toujours défendues dans sa quête permanente de l'excellence. Située dans le cadre majestueux du golfe d'Izmir, en Turquie, l'usine Anatolia incarne une vision novatrice du design qui va transformer notre façon de concevoir les surfaces. Ce site réunit le département de recherche et développement, les salles d'exposition et les bureaux de l'entreprise. Véritable centre d'innovation, il dispose d'une usine de fabrication et d'un centre logistique à la pointe de la technologie.

#### ES VALORES FUNDAMENTALES Y PRESENCIA GLOBAL

La empresa ocupa una posición destacada en el mercado mundial de superficies, materiales arquitectónicos y soluciones de diseño. La innovación continua, la investigación tecnológica, la visión internacional y la responsabilidad social y medioambiental son los valores fundamentales que Anatolia ha mantenido siempre en su búsqueda constante de la excelencia. La fábrica de Anatolia, situada en el majestuoso golfo de Esmirna, en Turquía, encarna una visión innovadora del diseño que va a transformar nuestra forma de concebir las superficies. Las instalaciones albergan el departamento de investigación y desarrollo de la empresa, salas de exposición y oficinas, lo que la convierte en un importante centro de innovación con una planta de fabricación y un centro logístico de última generación.

#### TR TEMEL DEĞERLER VE KÜRESEL VARLIK

Anatolia, yüzeyler, mimari malzemeler ve tasarım çözümleri alanında küresel pazarda güçlü bir konuma sahiptir. Sürekli yenilik, teknolojik araştırma, uluslararası bakış açısı ile sosyal ve çevresel sorumluluk, Anatolia'nın mükemmellik yolculuğunda daima savunduğu temel değerlerdir. Türkiye'nin büyüleyici İzmir Körfezi'nde yer alan Anatolia üretim tesisi, yüzeylere bakış açımızı dönüştürmeyi hedefleyen yenilikçi bir tasarım vizyonunu yansıtır. Tesis; şirketin araştırma-geliştirme departmanını, showromlarını ve ofislerini barındıran, son teknolojiye sahip üretim tesisi ve lojistik merkeziyle büyük bir inovasyon üssüdür.

#### EN ARCHITECTURAL DESIGN

Designed in partnership with Canadian studio Micacchi Architecture, the facility emphasizes and is a testament to Anatolia's passion for design and penchant for innovation. It features three distinct structures that, together, form an integrated production and design unit. The first is the main administrative building, a grand and refined architectural masterpiece that houses office space, showrooms, and research and product development labs. Simply walking through the space takes one on a visual journey through Anatolia's aesthetic vision.

The building adjoins a production plant with a capacity to expand to eleven lines equipped with advanced manufacturing equipment for producing tiles and slabs. The plant is conceived as a space for designers to experiment with materials and diverse methods to bring novel products to life.

Finally, an adjacent centralized storage space ensures the efficient and monitored gathering of both raw materials and finished products. With an impressive 2,267,450 ft<sup>2</sup> / 210,653 m<sup>2</sup>, the facility is one of the largest and most technologically advanced in the world.

#### FR CONCEPTION ARCHITECTURALE

Conçue en collaboration avec le studio canadien Micacchi Architecture, cette installation illustre parfaitement la passion d'Anatolia pour le design ainsi que son engagement envers l'innovation. Elle se compose de trois structures distinctes qui, réunies, forment une unité intégrée de production et de conception. La première est le bâtiment administratif principal, un chef-d'œuvre architectural grandiose et raffiné qui abrite des bureaux, des salles d'exposition et des laboratoires de recherche et de développement de produits. Il suffit de traverser cet espace pour être transporté dans un voyage visuel à travers la vision esthétique d'Anatolia. Le bâtiment est adjacent à une usine de production pouvant être agrandie jusqu'à onze lignes équipées de matériel de fabrication de pointe pour la production de carreaux et de dalles. L'usine est conçue comme un espace où les designers peuvent expérimenter différents matériaux et méthodes afin de donner vie à des produits novateurs. Enfin, un espace de stockage centralisé adjacent assure la collecte efficace et contrôlée des matières premières et des produits finis. Avec une superficie impressionnante de 210 653 m<sup>2</sup>, cette installation est l'une des plus grandes et des plus avancées technologiquement au monde.

#### ES DISEÑO ARQUITECTÓNICO

Diseñada en colaboración con el estudio canadiense Micacchi Architecture, la instalación destaca y es testimonio de la pasión de Anatolia por el diseño y su inclinación por la innovación. Cuenta con tres estructuras diferenciadas que, juntas, forman una unidad integrada de producción y diseño. La primera es el edificio administrativo principal, una obra maestra arquitectónica grandiosa y refinada que alberga oficinas, salas de exposición y laboratorios de investigación y desarrollo de productos. El simple hecho de recorrer el espacio supone un viaje visual a través de la visión estética de Anatolia. El edificio está contiguo a una planta de producción con capacidad para ampliarse a once líneas equipadas con avanzados equipos de fabricación para la producción de baldosas y losas. La planta está concebida como un espacio para que los diseñadores experimenten con materiales y métodos diversos para dar vida a productos novedosos. Por último, un espacio de almacenamiento centralizado adyacente garantiza la recogida eficiente y controlada tanto de las materias primas como de los productos acabados. Con una impresionante superficie de 210 653 m<sup>2</sup>, la instalación es una de las más grandes y tecnológicamente avanzadas del mundo.

#### TR MİMARİ TASARIM

Kanadalı Micacchi Architecture iş birliğiyle tasarlanan tesis, Anatolia'nın tasarımı olan tutkusunun ve yenilikçi yaklaşımının bir göstergesidir. Birbirini tamamlayan üç farklı yapıdan oluşan kompleks, entegre bir üretim ve tasarım birimi olarak kurgulanmıştır. İlki; ofis alanlarını, showroomları ve araştırma-geliştirme laboratuvarlarını barındıran, görkemli ve rafine bir mimari başyapıt olan ana idari binadır. Binada dolaşmak, Anatolia'nın estetik vizyonunda bir yolculuğa çıkmak gibidir. Bitişik konumdaki üretim tesisi, karo ve plaka üretimi için ileri üretim ekipmanlarıyla donatılmış, on bir hatta kadar kapasiteye sahip olacak şekilde tasarlanmıştır. Bu alan aynı zamanda tasarımcıların malzemeler ve farklı yöntemler üzerinde deneyler yaparak yeni ürünler geliştirebilecekleri bir yaratıcılık platformu olarak düşünülmüştür. Son olarak, yanındaki merkezi depolama alanı, hammadde ve bitmiş ürünlerin verimli ve kontrollü bir şekilde toplanmasını sağlar. Toplamda 210.653 m<sup>2</sup> (2.267.450 ft<sup>2</sup>) alana sahip olan tesis, dünyanın en büyük ve en ileri teknolojiye sahip üretim komplekslerinden biridir.



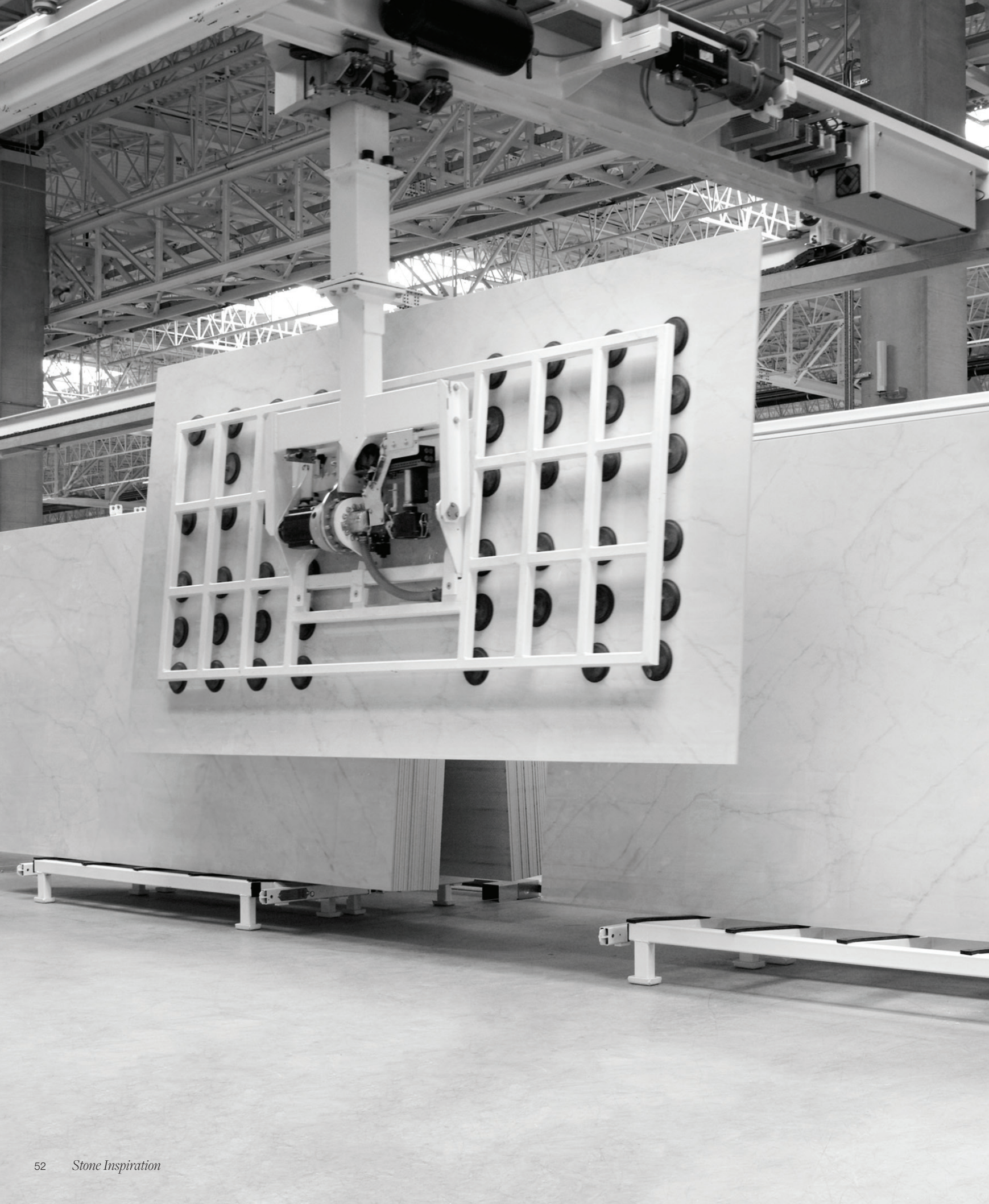

#### EN SUSTAINABILITY AND PRODUCTION INNOVATION

The design of the buildings and the innovative, integrated system for stocking and feeding natural raw materials reflect a commitment to efficiency, sustainability, and thoughtful industrial design—minimizing waste and energy consumption while supporting advanced production processes. The factory incorporates cutting-edge production technologies and prioritizes sustainability within the industry. Anatolia is poised to take the lead in meeting the surging demand for designer surfaces with its exceptional offerings. Join us on an extraordinary journey to redefine the essence of elegance and sophistication.

#### FR DURABILITÉ ET INNOVATION EN MATIÈRE DE PRODUCTION

La conception des bâtiments, ainsi que le système innovant et intégré de stockage et d'approvisionnement en matières premières naturelles, témoignent un engagement fort en faveur de l'efficacité, de la durabilité et d'une conception industrielle réfléchie. Ce dispositif permet de minimiser les déchets et la consommation d'énergie tout en soutenant des processus de production avancés. Intégrant des technologies de pointe, elle place la durabilité au cœur de son activité industrielle. Anatolia est prête à prendre la tête pour répondre à la demande croissante de surfaces design grâce à ses offres exceptionnelles. Rejoignez-nous dans ce voyage extraordinaire pour redéfinir l'essence même de l'élégance et du raffinement.

#### ES SOSTENIBILIDAD E INNOVACIÓN EN LA PRODUCCIÓN

El diseño de los edificios y el innovador sistema integrado de almacenamiento y alimentación de materias primas naturales reflejan un compromiso con la eficiencia, la sostenibilidad y un diseño industrial cuidadoso, que minimiza los residuos y el consumo de energía, al tiempo que respalda procesos de producción avanzados. La fábrica incorpora tecnologías de producción de vanguardia y da prioridad a la sostenibilidad dentro de la industria. Anatolia está preparada para liderar la creciente demanda de superficies de diseño con sus excepcionales productos. Acompáñenos en un viaje extraordinario para redefinir la esencia de la elegancia y la sofisticación.

#### TR SÜRDÜRÜLEBİLİRLİK VE ÜRETİM İNOVASYONU

Binaların tasarımı ve doğal hammaddelerin depolanması ile beslenmesi için geliştirilen yenilikçi, entegre sistem; verimlilik, sürdürülebilirlik ve özenli endüstriyel tasarıma olan bağlılığımızı yansıtır. Bu sayede atık ve enerji tüketimi en aza indirilirken, gelişmiş üretim süreçleri desteklenir. Fabrika, en son üretim teknolojilerini kullanır ve sektörde sürdürülebilirliği ön planda tutar. Anatolia, üstün ürünleriyle tasarım yüzeylere yönelik artan talebi karşılama liderliği üstlenmeye hazırdır. Zarafetin ve sofistikliğin özünü yeniden tanımlamak için olağanüstü bir yolculuğa çıkar.



## SUSTAINABILITY

<sup>EN</sup> Anatolia's manufacturing facility, warehouse, and operational infrastructure have been carefully conceived to harmoniously integrate cutting-edge technology, thoughtfully harnessed to minimize our environmental footprint, enhance operational efficiency, and above all, produce industry leading products for the global design community.

<sup>FR</sup> L'usine, l'entrepôt et l'infrastructure opérationnelle d'Anatolia ont été soigneusement conçus pour intégrer harmonieusement des technologies de pointe, judicieusement employées pour minimiser notre empreinte environnementale, améliorer l'efficacité opérationnelle et, surtout, produire des produits de premier choix pour la communauté mondiale des créateurs.

<sup>ES</sup> La planta industrial, el depósito y la infraestructura operativa de Anatolia han sido cuidadosamente concebidos para a integrar de manera armoniosa tecnología de última generación aplicada con inteligencia, con el fin de minimizar nuestra huella ambiental, optimizar la eficiencia operativa y, sobre todo, crear los mejores productos del sector para la comunidad de diseño mundial.

<sup>TR</sup> Anatolia'nın üretim tesisi, deposu ve operasyonel altyapısı, çevre ayak izimizi en aza indirmek, operasyonel verimliliği artırmak ve her şeyden önemlisi, küresel tasarım topluluğu için sektör lideri ürünler üretmek amacıyla ve en son teknolojiyi uyumlu bir şekilde entegre etmek üzere özenle tasarlanmıştır.

<sup>EN</sup> LEED Certification – The production facility and administrative office building are designed and constructed with the aim to achieve a LEED Certification, which provides a framework for healthy, highly efficient, and cost-saving green buildings, which offer environmental, social and governance benefits.

<sup>FR</sup> CERTIFICATION LEED – Le site de production et le bâtiment administratif ont été conçus et construits dans le but d'obtenir une certification LEED, qui fournit un cadre pour la construction de bâtiments écologiques sains, hautement efficaces et économes, qui offrent des avantages sur le plan environnemental, social et de la gouvernance.

<sup>ES</sup> CERTIFICACIÓN LEED – La planta industrial y las oficinas fueron diseñadas y construidas con certificación LEED, la cual provee un marco rector para construcciones saludables, altamente eficientes, económicas y amigables con el medio ambiente, con beneficios ambientales, sociales y gubernamentales.

<sup>TR</sup> LEED Sertifikası – Üretim tesisi ve idari ofis binası, çevresel, sosyal ve yönetsel avantajlar sunan sağlıklı, yüksek verimli ve tasarruflu yeşil binalar için bir çerçeve oluşturan LEED Sertifikası almayı hedefleyerek tasarlanmış ve inşa edilmiştir.

## SOLAR PANELS

<sup>EN</sup> Cutting-edge solar panels, encompassing the entire roof of the facilities at a total of 2,267,450 sq ft / 210,653 m<sup>2</sup>, have been installed and generate an impressive 21.5 MW of energy. This substantial output will fulfill a significant portion of the energy needs of our production plant, while concurrently facilitating a substantial reduction of carbon emissions. This environmentally conscious initiative will effectively prevent the release of 19,000 tons of carbon into the atmosphere annually.

<sup>FR</sup> PANNEAUX SOLAIRES – Des panneaux solaires à la pointe de la technologie, couvrant la totalité de la toiture des installations sur une surface totale de 210 653 m<sup>2</sup> génèrent une quantité impressionnante d'énergie de 21,5 MW. Cette production substantielle répondra à une grande partie des besoins énergétiques de notre usine de production, tout en facilitant une réduction substantielle des émissions de carbone. Cette initiative respectueuse de l'environnement permettra d'éviter le rejet de 19 000 tonnes de carbone dans l'atmosphère chaque année.

<sup>ES</sup> PANELES SOLARES – Se están instalando paneles solares de última generación en la totalidad de los 2.267.450 ft<sup>2</sup> / 210.653 m<sup>2</sup> del techo de la planta, con miras a generar 21,5 MW de energía. Se prevé que ese importante aporte satisfará buena parte de los requerimientos energéticos de nuestra planta de fabricación, promoviendo a la vez una baja significativa en la emisión de gases de efecto invernadero. Esta iniciativa planteada con conciencia ambiental efectivamente impedirá que cada año se viertan 19.000 toneladas de anhídrido carbónico a la atmósfera.

<sup>TR</sup> GÜNEŞ PANELLERİ – Toplamda 2.267.450 fit kare / 210.653 metrekarelik alanın tüm çatısını kaplayan son teknoloji güneş panelleri kuruldu ve 21,5 MW gibi etkileyici seviyede enerji üretilmektedir. Bu önemli çıktı sayesinde üretim tesisimizin enerji ihtiyacının önemli bir bölümü karşılanırken, aynı zamanda karbon emisyonlarında önemli ölçüde azalma sağlanması beklenmektedir. Bu çevre dostu girişim, yılda 19.000 ton karbonun atmosfere salınmasını etkili bir şekilde önleyecektir.



## FACILITY WATER TREATMENT RAINWATER COLLECTION SYSTEM

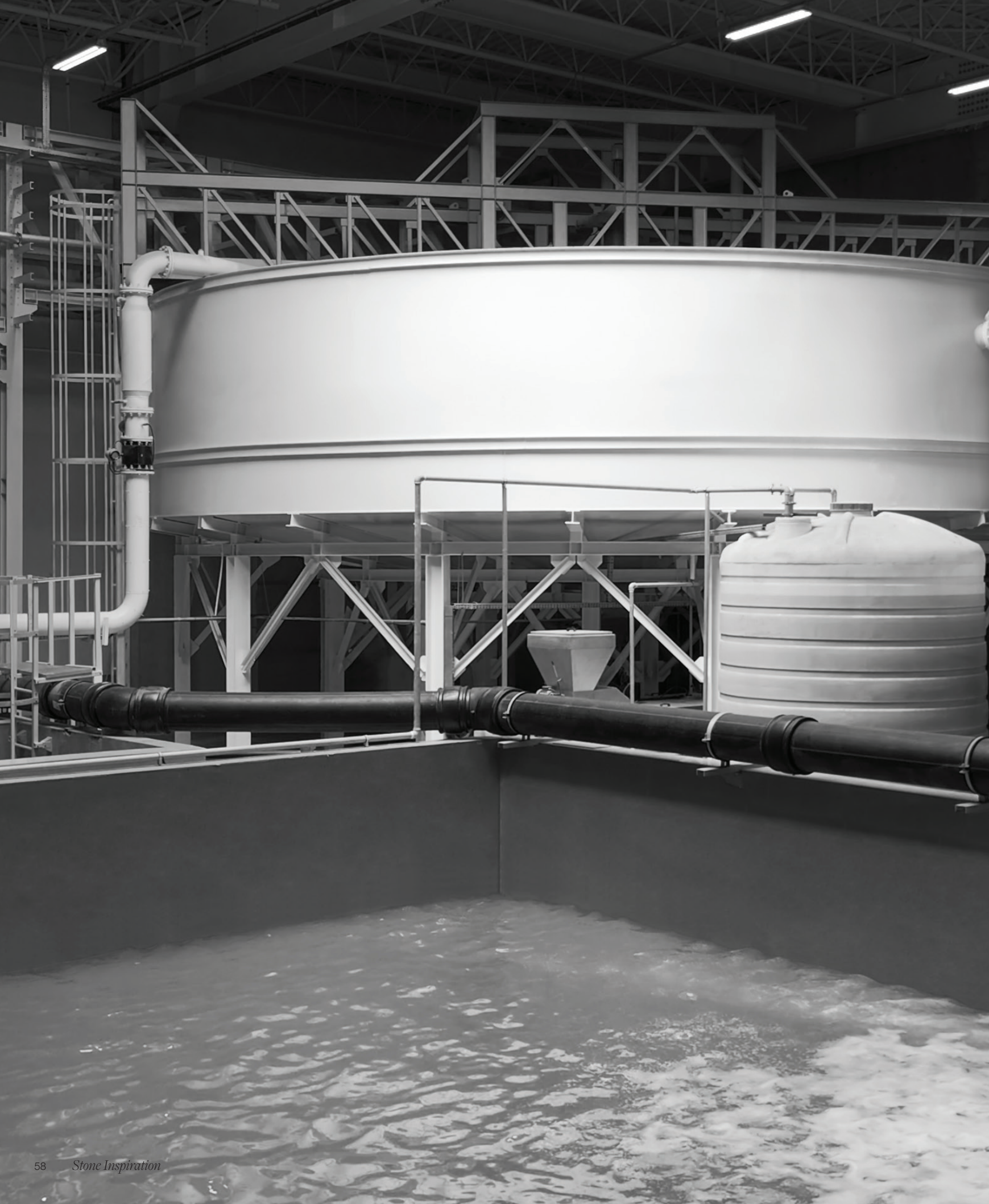

<sup>EN</sup> Our operational water resources are in a 100% closed-loop recycling system, employing state-of-the-art recycling and treatment technologies at the height of industry standards. Housed indoors within our production facility, our treatment plant serves as a pivotal element in our commitment to environmental best practices. This strategic placement effectively curtails the risk of environmental water contamination, ensuring the utmost purity of our product offerings. Our indoor treatment significantly reduces evaporation, effectively mitigating water loss during the process and solidifying our position as one of the industry's preeminent examples of water efficiency.

<sup>FR</sup> TRAITEMENT DE L'EAU – Nos ressources en eau sont recyclées à 100 % en circuit fermé, en utilisant des technologies de recyclage et de traitement à la pointe des normes industrielles. Située au sein même de notre site de production, notre station d'épuration est un élément essentiel de notre engagement en faveur des meilleures pratiques environnementales. Cet emplacement stratégique réduit efficacement le risque de contamination de l'eau dans l'environnement, garantissant ainsi la plus grande pureté de nos produits. Notre station d'épuration intérieure réduit considérablement l'évaporation, en atténuant efficacement les pertes d'eau au cours du processus et en consolidant notre position comme l'un des meilleurs exemples de gestion efficace de l'eau dans l'industrie.

<sup>ES</sup> TRATAMIENTO DE AGUAS EN INSTALACIONES – Nuestros recursos hídricos están en un sistema de reciclaje de circuito cerrado al 100% que emplea tecnologías de reciclaje y tratamiento de última generación, según los más altos estándares del sector. Ubicada en un espacio interior dentro de la planta de fabricación, nuestra planta de tratamiento de aguas juega un rol fundamental en nuestra firme adhesión a las mejores prácticas medioambientales. Su ubicación estratégica efectivamente limita el riesgo de contaminación del agua, asegura la máxima pureza de nuestra producción. El tratamiento de aguas en un espacio interior reduce significativamente la evaporación, mitiga la pérdida de agua durante el proceso y fortaleciendo nuestra posición como uno de los más destacados ejemplos de eficiencia hídrica del sector.

<sup>TR</sup> TESIS SU ARITMA SİSTEMİ – Operasyonel su kaynaklarımız, sektör standartlarının en üst seviyesinde son teknoloji geri dönüşüm ve artma sistemleri kullanan %100 kapalı devre bir geri dönüşüm sisteminde yer almaktadır. Üretim tesisimizin içinde bulunan artma tesisimiz, çevresel en iyi uygulamalara olan bağlılığımızda merkezi bir rol oynamaktadır. Bu stratejik konum, çevresel su kirliliği riskini etkili bir şekilde önleyerek üretimde en yüksek saflığı garanti eder. Kapalı alanda yapılan artma, buharlaşmayı önemli ölçüde azaltarak süreçteki su kaybını minimize eder ve su verimliliği konusunda sektörün önde gelen örneklerinden biri olarak konumumuzu sağlamlaştırmaktadır.

<sup>EN</sup> Sustaining a tranquil and aesthetically pleasing outdoor green oasis for employee relaxation necessitates a reliable water source to nurture thriving plant life. In our commitment to water conservation, we have implemented a system that harvests rainwater from a generous 31,815 m<sup>2</sup> rooftop, storing it in a 2,200 ton cistern for efficient utilization in our irrigation process.

<sup>FR</sup> SYSTÈME DE COLLECTE DES EAUX DE PLUIE – Le maintien d'une oasis de verdure extérieure tranquille et esthétique pour la détente des employés nécessite une source d'eau fiable pour nourrir une vie végétale florissante. Dans le cadre de notre engagement en faveur de la conservation de l'eau, nous avons mis en place un système qui recueille l'eau de pluie d'une toiture généreuse de 31 815 m<sup>2</sup> et la stocke dans une citerne de 2 100 tonnes pour l'utiliser efficacement dans notre processus d'irrigation.

<sup>ES</sup> SISTEMA DE RECOLECCIÓN DE AGUA DE LLUVIA – A fin de mantener un apacible y atractivo oasis al aire libre para el descanso del personal, se requiere una fuente de agua confiable para el riego de la vegetación. Fieles a nuestro compromiso con la conservación del agua, hemos implementado un sistema que cosecha el agua de lluvia proveniente de un amplio techo de 31.815 m<sup>2</sup>, almacenándola en una cisterna de 2.100 toneladas para la eficiente instrumentación del riego.

<sup>TR</sup> YAĞMUR SUYU TOPLAMA SİSTEMİ – Çalışanların dinlenmesi için sakin ve estetik açıdan hoş bir yeşil dış mekân vahası oluşturmak, sağlıklı bitki örtüsünü besleyecek güvenilir bir su kaynağı gerektirir. Su tasarrufuna olan bağlılığımız doğrultusunda, 31.815 m<sup>2</sup>'lik geniş çatı alanımızdan yağmur suyunu toplayarak, 2.200 ton kapasiteli bir sarnıçta depoluyor ve sulama sürecinde verimli bir şekilde kullanıyoruz.

## KILN AND PRESS ENERGY SAVINGS

<sup>EN</sup> Anatolia has strategically aligned with global machinery innovation leaders celebrated for their pioneering research and groundbreaking innovations. This cutting-edge technology epitomizes world-class ingenuity, delivering considerable energy conservation and waste reduction advantages to our production facilities.

<sup>FR</sup> **FOURS ET PRESSES ÉCOÉNERGÉTIQUES** – Anatolia s'est stratégiquement alignée sur les leaders mondiaux de l'innovation en matière de machines réputée pour ses recherches pionnières et ses innovations révolutionnaires. La technologie de pointe incarne l'ingéniosité de classe mondiale et offre à nos installations de production des avantages considérables en matière d'économie d'énergie et de réduction des déchets.

<sup>ES</sup> **AHORRO DE ENERGÍA CON HORNO Y PRENSA** – Anatolia se ha alineado estratégicamente con referentes mundiales en materia de innovación de maquinaria célebre por sus investigaciones pioneras e innovaciones revolucionarias. Esta tecnología avanzada encarna lo máximo en inventiva, ya que habilita una considerable conservación de la energía y brinda a nuestra planta industrial ventajas en materia de reducción de residuos.

<sup>TR</sup> **FIRIN VE PRES ENERJİ VERİMLİLİĞİ** – Anatolia, öncü araştırmaları ve çığır açan inovasyonlarıyla tanınan küresel makine inovasyonu liderleriyle stratejik ortaklıklar kurmuştur. Bu son teknoloji, dünya çapında bir dehanın somut örneği olup, üretim tesislerimize önemli enerji tasarrufu ve atık azaltma avantajları sunar.



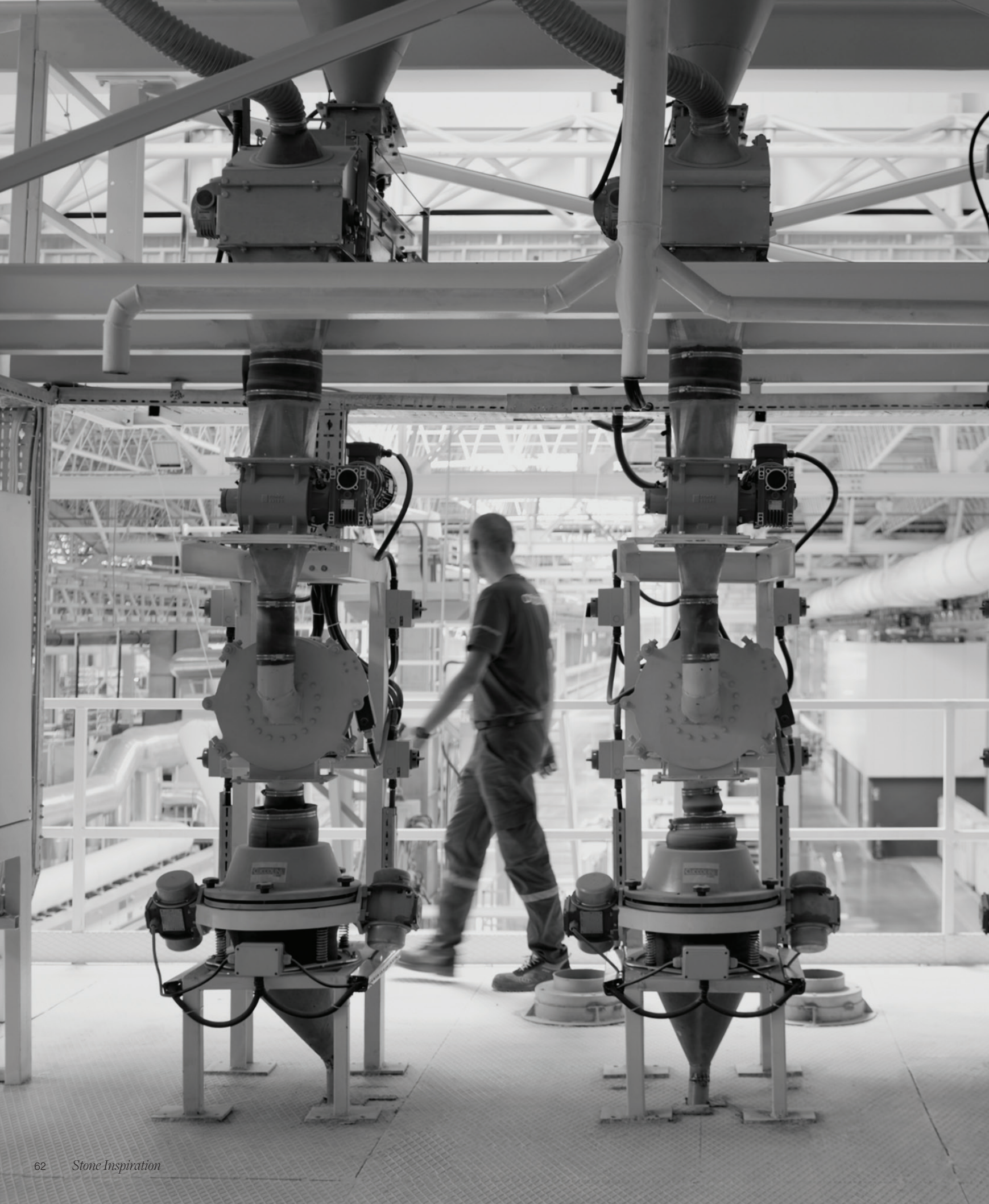

## CERTIFICATIONS



### CONFORMITÉ EUROPÉENNE (CE)

<sup>EN</sup> Meets EU safety, health, and environmental protection standards for products sold within the European Economic Area.

<sup>FR</sup> Conforme aux normes européennes en matière de sécurité, de santé et de protection de l'environnement pour les produits vendus dans l'Espace économique européen.

<sup>ES</sup> Cumple con las normas de seguridad, salud y protección medioambiental de la UE para productos vendidos dentro del Espacio Económico Europeo.

<sup>TR</sup> Ürünlerimiz, Avrupa Ekonomik Alanı'nda geçerli olan güvenlik, sağlık ve çevre koruma standartlarını karşılayarak CE belgesiyle tescillenmiştir.



### UNITED KINGDOM CONFORMITY ASSESSED (UKCA):

<sup>EN</sup> Complies with UK safety and performance regulations for products marketed in Great Britain.

<sup>FR</sup> Conforme aux réglementations britanniques en matière de sécurité et de performance pour les produits commercialisés en Grande-Bretagne.

<sup>ES</sup> Cumple con las normas de seguridad y rendimiento del Reino Unido para productos comercializados en Gran Bretaña.

<sup>TR</sup> Birleşik Krallık'ta yürürlükte olan güvenlik ve performans düzenlemelerine tam uyum sağlayan ürünlerimiz, UKCA sertifikasıyla onaylanmıştır.



### ISO 9001

<sup>EN</sup> Certified quality management system: demonstrates compliance with internationally recognized quality management principles, ensuring consistent product and service quality while meeting customer expectations and regulatory requirements.

<sup>FR</sup> Système de gestion de la qualité certifié: démontre la conformité aux principes de gestion de la qualité reconnus à l'échelle internationale, garantissant une qualité constante des produits et des services tout en répondant aux attentes des clients et aux exigences réglementaires.

<sup>ES</sup> Sistema de gestión de calidad certificado: demuestra el cumplimiento de los principios de gestión de calidad reconocidos internacionalmente, lo que garantiza una calidad constante de los productos y servicios, al tiempo que se satisfacen las expectativas de los clientes y los requisitos reglamentarios.

<sup>TR</sup> Kalite yönetiminde uluslararası standart. Ürün ve hizmet kalitemizin sürekliliğini, müşteri beklentilerine ve yasal gerekliliklere uyumlu bir şekilde sağladığımızın göstergesi olan ISO 9001, uluslararası kabul görmüş kalite yönetim ilkelerine bağlılığımızı belgelendirir.



### ISO 5001

<sup>EN</sup> Certified energy management system: supports improved energy efficiency by reducing energy consumption and carbon emissions, demonstrating a commitment to responsible and sustainable energy use.

<sup>FR</sup> Système de gestion énergétique certifié : favorise l'amélioration de l'efficacité énergétique en réduisant la consommation d'énergie et les émissions de carbone, démontrant ainsi un engagement en faveur d'une utilisation responsable et durable de l'énergie.

<sup>ES</sup> Sistema de gestión energética certificado: favorece la mejora de la eficiencia energética mediante la reducción del consumo de energía y las emisiones de carbono, lo que demuestra un compromiso con el uso responsable y sostenible de la energía.

<sup>TR</sup> Enerji yönetiminde uluslararası standart. Enerji tüketimini ve karbon emisyonlarını azaltarak enerji verimliliğini artırmayı destekler; sorumlu ve sürdürülebilir enerji kullanımına bağlılığımızı gösterir.



### ISO 14001

<sup>EN</sup> Certified environmental management system: validates full compliance with environmental regulations while reducing environmental impact and promoting efficient resource use throughout the product life cycle.

<sup>FR</sup> Système de gestion environnementale certifié: garantit le respect total des réglementations environnementales tout en réduisant l'impact sur l'environnement et en favorisant une utilisation efficace des ressources tout au long du cycle de vie du produit.

<sup>ES</sup> Sistema de gestión medioambiental certificado: valida el cumplimiento total de la normativa medioambiental, al tiempo que reduce el impacto medioambiental y promueve el uso eficiente de los recursos a lo largo del ciclo de vida del producto.

<sup>TR</sup> Çevre yönetiminde uluslararası standart. Çevre düzenlemelerine tam uyumu belgeleyen bu sertifika, ürün yaşam döngüsü boyunca çevresel etkiyi azaltmayı ve kaynak kullanımında verimliliği teşvik etmeyi amaçlar.



### ÉMISSIONS DANS L'AIR INTÉRIEUR

<sup>EN</sup> Rated A+ for very low emissions of volatile organic compounds (VOCs), contributing to healthier indoor air quality.

<sup>FR</sup> Classé A+ pour ses très faibles émissions de composés organiques volatils (COV), contribuant ainsi à une meilleure qualité de l'air intérieur.

<sup>ES</sup> Calificado con la categoría A+ por sus emisiones muy bajas de compuestos orgánicos volátiles (COV), lo que contribuye a una calidad del aire interior más saludable.

<sup>TR</sup> Çok düşük VOC (uçucu organik bileşik) emisyonlarıyla A+ derecesi almış, daha sağlıklı bir iç mekân havasına katkı sağlar.



### CHINA COMPULSORY CERTIFICATION (CCC)

<sup>EN</sup> Ensures product safety and quality compliance, allowing free circulation of products in the Chinese market.

<sup>FR</sup> Garantit la sécurité et la conformité des produits, permettant leur libre circulation sur le marché chinois.

<sup>ES</sup> Garantiza la seguridad y el cumplimiento de los requisitos de calidad de los productos, lo que permite su libre circulación en el mercado chino.

<sup>TR</sup> Çin pazarında ürün güvenliği ve kalite uyumluluğunu belgeleyen bu sertifika, ürünlerin Çin'de serbestçe dolaşımını sağlar.



### GREENGUARD GOLD

<sup>EN</sup> Certified for cleaner indoor air - tested and certified for very low volatile organic compound (VOC) emissions, making it safe for indoor environments. GREENGUARD Gold sets even stricter VOC limits, proving it to be ideal for use in schools, healthcare facilities, and other sensitive environments.

<sup>FR</sup> Certifié pour un air intérieur plus pur: testé et certifié pour ses très faibles émissions de composés organiques volatils (COV), ce qui le rend sûr pour les environnements intérieurs. GREENGUARD Gold fixe des limites de COV encore plus strictes, ce qui le rend idéal pour une utilisation dans les écoles, les établissements de santé et autres environnements sensibles.

<sup>ES</sup> Certificado para un aire interior más limpio: probado y certificado por sus emisiones muy bajas de compuestos orgánicos volátiles (COV), lo que lo hace seguro para entornos interiores. GREENGUARD Gold establece límites de COV aún más estrictos, lo que lo hace ideal para su uso en escuelas, centros sanitarios y otros entornos sensibles.

<sup>TR</sup> İç mekân hava kalitesi için güvence altına alınmış ürünler. Çok düşük uçucu organik bileşik (VOC) emisyonları için test edilmiş ve sertifikalandırılmış olan ürünlerimiz, iç mekânlarda güvenle kullanılabilir. GREENGUARD Gold, daha katı VOC sınırlarıyla, okullar, sağlık kuruluşları ve diğer hassas alanlarda kullanım için ideal olduğunu kanıtlamaktadır.



### TSE CERTIFIED QUALITY

<sup>EN</sup> Manufactured to international standards: our products are officially certified by the Turkish Standards Institution (TSE) and fully comply with the internationally recognized EN 14411 standard - a mark of outstanding quality and reliability.

<sup>FR</sup> Fabriqués selon les normes internationales, nos produits sont officiellement certifiés par l'Institut turc de normalisation (TSE) et sont entièrement conformes à la norme EN 14411 reconnue internationalement, gage d'une qualité et d'une fiabilité exceptionnelles.

<sup>ES</sup> Fabricados según las normas internacionales, nuestros productos están certificados oficialmente por la Institución Turca de Normalización (TSE) y cumplen plenamente con la norma EN 14411, reconocida internacionalmente, una garantía de calidad y fiabilidad excepcionales.

<sup>TR</sup> Anadolu, uluslararası standartlarda üretim yapma kararlılığını Türk Standartları Enstitüsü (TSE) tarafından belgelendirmiştir. Ürünlerimiz, üstün kalite ve güvenilirliğin göstergesi olan EN 14411 standardına tam uyum sağlar.

# Packaging information

Key logistical details including item codes and product specifications.









## Lithoform Product & Packaging Information

SLABS	ACTUAL DIMENSIONS	THICKNESS	CROSSCUT DUNES ITEM CODES	CROSSCUT COAST ITEM CODES	CROSSCUT VISTA ITEM CODES	CROSSCUT TWILIGHT ITEM CODES	VEINCUT DUNES ITEM CODES
63 x 126 in / 160 x 320 cm HONED RECTIFIED COLORSYNC SINTERED SLAB	1600 x 3200 mm	6 mm	8000-0548-1	8000-0545-1	8000-0551-1	N/A	8000-0556-1
63 x 126 in / 160 x 320 cm ORGANIC MATTE RECTIFIED COLORSYNC SINTERED SLAB	1600 x 3200 mm	6 mm	8000-0550-1	8000-0547-1	8000-0553-1	N/A	8000-0557-1
63 x 126 in / 160 x 320 cm VINTAGE RECTIFIED COLORSYNC SINTERED SLAB	1600 x 3200 mm	6 mm	8000-0549-0	8000-0546-0	8000-0552-0	N/A	N/A
48 x 110 in / 119.8 x 279.8 cm LITHOFORM HONED RECTIFIED COLORSYNC PORCELAIN SLAB	1198 x 2798 mm	6 mm	8500-0080-0	8500-0083-0	8500-0086-0	8500-0089-0	8500-0092-0
48 x 110 in / 119.8 x 279.8 cm LITHOFORM ORGANIC MATTE RECTIFIED COLORSYNC PORCELAIN SLAB	1198 x 2798 mm	6 mm	8500-0081-0	8500-0084-0	8500-0087-0	8500-0090-0	8500-0093-0
TILES							
48 x 48 in / 119.8 x 119.8 cm LITHOFORM HONED RECTIFIED COLORSYNC PORCELAIN TILE	1198 x 1198 mm	9 mm	8500-0170-0	8500-0173-0	8500-0176-0	8500-0179-0	N/A
48 x 48 in / 119.8 x 119.8 cm LITHOFORM ORGANIC MATTE RECTIFIED COLORSYNC PORCELAIN TILE	1198 x 1198 mm	9 mm	8500-0171-0	8500-0174-0	8500-0177-0	8500-0180-0	N/A
36 x 72 in / 89.8 x 179.8 cm LITHOFORM HONED RECTIFIED COLORSYNC PORCELAIN TILE	898 x 1798 mm	9 mm	N/A	N/A	N/A	N/A	8500-0612-0
36 x 72 in / 89.8 x 179.8 cm LITHOFORM ORGANIC MATTE RECTIFIED COLORSYNC PORCELAIN TILE	898 x 1798 mm	9 mm	N/A	N/A	N/A	N/A	8500-0613-0
36 x 72 in / 89.8 x 179.8 cm LITHOFORM VINTAGE RECTIFIED COLORSYNC PORCELAIN TILE	898 x 1798 mm	9 mm	N/A	N/A	N/A	N/A	8500-0614-0
36 x 36 in / 89.8 x 89.8 cm LITHOFORM HONED RECTIFIED COLORSYNC PORCELAIN TILE	898 x 898 mm	9 mm	8500-0571-0	8500-0569-0	8500-0575-0	8500-0573-0	N/A
36 x 36 in / 89.8 x 89.8 cm LITHOFORM ORGANIC MATTE RECTIFIED COLORSYNC PORCELAIN TILE	898 x 898 mm	9 mm	8500-0572-0	8500-0570-0	8500-0576-0	8500-0574-0	N/A
24 x 48 in / 59.8 x 119.8 cm LITHOFORM HONED RECTIFIED COLORSYNC PORCELAIN TILE	598 x 1198 mm	9 mm	8500-0465-0	8500-0459-0	8500-0477-0	8500-0471-0	8500-0468-0
24 x 48 in / 59.8 x 119.8 cm LITHOFORM ORGANIC MATTE RECTIFIED COLORSYNC PORCELAIN TILE	598 x 1198 mm	9 mm	8500-0466-0	8500-0460-0	8500-0478-0	8500-0472-0	8500-0469-0
24 x 48 in / 59.8 x 119.8 cm LITHOFORM VINTAGE RECTIFIED COLORSYNC PORCELAIN TILE	598 x 1198 mm	9 mm	8500-0467-0	8500-0461-0	8500-0479-0	8500-0473-0	8500-0470-0
24 x 24 in / 59.8 x 59.8 cm LITHOFORM HONED RECTIFIED COLORSYNC PORCELAIN TILE	598 x 598 mm	9 mm	8500-0244-0	8500-0241-0	8500-0250-0	8500-0247-0	N/A
24 x 24 in / 59.8 x 59.8 cm LITHOFORM ORGANIC MATTE RECTIFIED COLORSYNC PORCELAIN TILE	598 x 598 mm	9 mm	8500-0245-0	8500-0242-0	8500-0251-0	8500-0248-0	N/A
24 x 24 in / 59.8 x 59.8 cm LITHOFORM VINTAGE RECTIFIED COLORSYNC PORCELAIN TILE	598 x 598 mm	9 mm	8500-0246-0	8500-0243-0	8500-0252-0	8500-0249-0	N/A
12 x 24 in / 29.8 x 59.8 cm LITHOFORM HONED RECTIFIED COLORSYNC PORCELAIN TILE	298 x 598 mm	9 mm	8500-0343-0	8500-0337-0	8500-0355-0	8500-0349-0	8500-0346-0
12 x 24 in / 29.8 x 59.8 cm LITHOFORM ORGANIC MATTE RECTIFIED COLORSYNC PORCELAIN TILE	298 x 598 mm	9 mm	8500-0344-0	8500-0338-0	8500-0356-0	8500-0350-0	8500-0347-0
12 x 24 in / 29.8 x 59.8 cm LITHOFORM VINTAGE RECTIFIED COLORSYNC PORCELAIN TILE	298 x 598 mm	9 mm	8500-0345-0	8500-0339-0	8500-0357-0	8500-0351-0	8500-0348-0
PAVERS							
36 x 36 in / 89.8 x 89.8 cm LITHOFORM VINTAGE RECTIFIED COLORSYNC PORCELAIN PAVER	898 x 898 mm	20 mm	8500-0659-0	8500-0660-0	8500-0661-0	8500-0662-0	N/A
24 x 48 in / 59.8 x 119.8 cm LITHOFORM VINTAGE RECTIFIED COLORSYNC PORCELAIN PAVER	598 x 1198 mm	20 mm	8500-0677-0	8500-0678-0	8500-0679-0	8500-0680-0	8500-0681-0
MOSAIC							
4 in / 10 cm LITHOFORM ORGANIC MATTE HEXAGON COLORSYNC PORCELAIN MOSAIC	284 x 284 mm	9 mm	8510-0031-0	8510-0032-0	8510-0033-0	8510-0034-0	N/A
2 in / 5 cm LITHOFORM ORGANIC MATTE HEXAGON COLORSYNC PORCELAIN MOSAIC	298 x 298 mm	9 mm	N/A	N/A	N/A	N/A	8510-0035-0

VEINCUT COAST ITEM CODES	VEINCUT VISTA ITEM CODES	VEINCUT TWILIGHT ITEM CODES	LBS BOX	KGS BOX	PCS BOX	SQFT BOX	M <sup>2</sup> BOX	BXS SKID	SQFT SKID	M <sup>2</sup> SKID
8000-0554-1	8000-0558-1	N/A								
8000-0555-1	8000-0559-1	N/A								
N/A	N/A	N/A								
8500-0095-0	8500-0098-0	8500-0101-0								
8500-0096-0	8500-0099-0	8500-0102-0								
N/A	N/A	N/A	137.78	62.5	2	30.89	2.87	16	494.24	45.92
N/A	N/A	N/A	137.78	62.5	2	30.89	2.87	16	494.24	45.92
8500-0609-0	8500-0618-0	8500-0615-0	154.33	70	2	34.77	3.23	16	556.32	51.68
8500-0610-0	8500-0619-0	8500-0616-0	154.33	70	2	34.77	3.23	16	556.32	51.68
8500-0611-0	8500-0620-0	8500-0617-0	154.33	70	2	34.77	3.23	16	556.32	51.68
N/A	N/A	N/A	77.16	35	2	17.33	1.61	30	519.9	48.3
N/A	N/A	N/A	77.16	35	2	17.33	1.61	30	519.9	48.3
8500-0462-0	8500-0480-0	8500-0474-0	68.34	31	2	15.39	1.43	32	492.48	45.76
8500-0463-0	8500-0481-0	8500-0475-0	68.34	31	2	15.39	1.43	32	492.48	45.76
8500-0464-0	8500-0482-0	8500-0476-0	68.34	31	2	15.39	1.43	32	492.48	45.76
N/A	N/A	N/A	51.81	23.5	3	11.52	1.07	42	483.84	44.94
N/A	N/A	N/A	51.81	23.5	3	11.52	1.07	42	483.84	44.94
N/A	N/A	N/A	51.81	23.5	3	11.52	1.07	42	483.84	44.94
8500-0340-0	8500-0358-0	8500-0352-0	51.81	23.5	6	11.52	1.07	48	552.96	51.36
8500-0341-0	8500-0359-0	8500-0353-0	51.81	23.5	6	11.52	1.07	48	552.96	51.36
8500-0342-0	8500-0360-0	8500-0354-0	51.81	23.5	6	11.52	1.07	48	552.96	51.36
N/A	N/A	N/A	84.87	38.5	1	8.68	0.81	28	243.04	22.58
8500-0682-0	8500-0683-0	8500-0684-0	75.4	34.2	1	7.71	0.72	32	246.76	22.92
N/A	N/A	N/A	47.31	21.46	10	8.72	0.81	45	392.4	36.45
8510-0036-0	8510-0037-0	8510-0038-0	45.66	20.71	10	9.58	0.89	45	431.1	40.05

# Lithoform - Technical information

Collection performance based on industry standards.

Technical Information					
	WATER ABSORPTION	ANSI / ISO - (%)	< 0.1%		
	ABRASION RESISTANCE	ANSI / ISO	HONED <140mm <sup>3</sup>	ORGANIC MATTE <120mm <sup>3</sup>	VINTAGE <120mm <sup>3</sup>
	BREAKING STRENGTH	ANSI - (Ibf) ISO - (N)	6 mm ≥310 ≥1500	9 mm ≥570 ≥2600	20 mm PAVER ≥2925 ≥13000
	SHADE VARIATION		V2		
	SLIP RESISTANCE	ANSI DCOF (WET) ISO - R VALUE	HONED >0.50 DRY (ID) HONED R(-)	ORGANIC MATTE ≥0.60 (ID, IW, IW+, EW*, O/G*) ORGANIC MATTE R10	VINTAGE ≥0.75 (ID, IW, IW+, EW*, O/G*) VINTAGE R11
	CHEMICAL RESISTANCE	ANSI / ISO	HONED CLASS A / MIN. CLASS B	ORGANIC MATTE CLASS A	VINTAGE CLASS A
	STAIN RESISTANCE	ANSI / ISO	HONED CLASS A / CLASS 4	ORGANIC MATTE CLASS A / CLASS 5	VINTAGE CLASS A / CLASS 5
	FROST RESISTANCE	ANSI / ISO	PASS		

Test values are based on ANSI / ISO standards according to: ANSI A137.1 - Impervious (Porcelain) P1 Class, ISO 13006 - G - BI, Group, En 14411 - G - BI, Group. Variances in test values can occur in different production lots.

## Usage recommendation

Anatolia's recommendations for suitable applications.

Usage Recommendations*		HONED		ORGANIC MATTE		VINTAGE		VINTAGE PAVER	
APPLICATION		WALL	FLOOR	WALL	FLOOR	WALL	FLOOR	WALL	FLOOR
INTERIOR	RESIDENTIAL	•	ID	•	ID, IW, IW+, EW*, O/G*	•	ID, IW, IW+, EW*, O/G*		ID, IW, IW+, EW*, O/G*
	COMMERCIAL	•	ID	•	ID, IW, IW+, EW*, O/G*	•	ID, IW, IW+, EW*, O/G*		ID, IW, IW+, EW*, O/G*
	HEAVY COMMERCIAL	•		•		•		•	ID, IW, IW+, EW*, O/G*
EXTERIOR	RESIDENTIAL / COMMERCIAL	•		•	ID, IW, IW+, EW*, O/G*	•	ID, IW, IW+, EW*, O/G*	•	ID, IW, IW+, EW*, O/G*

\* These are Anatolia recommendations for suitable applications. They are not defined by ANSI / ISO Standards. DCOF Classifications per ANSI A326.3: (ID): Interior, Dry (IW): Interior, Wet (IW+): Interior, Wet Plus (EW): Exterior, Wet (O/G): Oils/Greases

## Slab Packaging Innovation

<sup>EN</sup> Engineered for excellence, Anatolia's patent pending Bundle-Frame, A-Frame, and Platform systems represent the industry benchmark in packaging innovation, redefining performance and eco-conscious design. Backed by extensive research, these solutions are designed with precision to maximize safety, efficiency, and sustainability throughout the logistics chain. They minimize workplace hazards and reduces the risk of slab damage during handling and transport, all while optimizing container utilization and warehouse storage. Designed for long-term reuse, these solutions significantly reduce material waste and environmental impact.

<sup>FR</sup> INNOVATION EN MATIÈRE D'EMBALLAGE – Conçus pour l'excellence, les systèmes Bundle-Frame, A-Frame et Platform d'Anatolia, en instance de brevet, constituent la référence dans le domaine de l'innovation en matière d'emballage, redéfinissant les performances et la conception écologique. S'appuyant sur des recherches approfondies, ces solutions sont conçues avec précision pour maximiser la sécurité, l'efficacité et la durabilité tout au long de la chaîne logistique. Elles minimisent les risques sur le lieu de travail et réduisent les risques d'endommagement des dalles pendant la manutention et le transport, tout en optimisant l'utilisation des conteneurs et le stockage en entrepôt. Conçues pour être réutilisées à long terme, ces solutions réduisent considérablement le gaspillage de matériaux et l'impact environnemental.

<sup>ES</sup> INNOVACIÓN EN EMBALAJE – Diseñados para alcanzar la excelencia, los sistemas Bundle-Frame, A-Frame y Platform de Anatolia, pendientes de patente, representan el punto de referencia del sector en innovación en embalaje, redefiniendo el rendimiento y el diseño ecológico. Respaldadas por una exhaustiva investigación, estas soluciones están diseñadas con precisión para maximizar la seguridad, la eficiencia y la sostenibilidad en toda la cadena logística. Minimizan los riesgos en el lugar de trabajo y reducen el riesgo de daños en las placas durante la manipulación y el transporte, al tiempo que optimizan la utilización de los contenedores y el almacenamiento en el almacén. Diseñadas para su reutilización a largo plazo, estas soluciones reducen significativamente el desperdicio de material y el impacto medioambiental.

<sup>TR</sup> YENİLİKÇİ AMBALAJ ÇÖZÜMLERİ – Mükemmellik için tasarlanan, Anatolia'nın patent başvurusu yapılmış Bundle-Frame, A-Frame ve Platform sistemleri, ambalaj inovasyonunda sektör standardını belirleyerek performansı ve çevre duyarlılığını yeniden tanımlıyor. Kapsamlı araştırmalarla geliştirilen bu çözümler; lojistik zincirinin her aşamasında güvenliği, verimliliği ve sürdürülebilirliği en üst düzeye çıkarmak için titizlikle tasarlanmıştır. İş güvenliği risklerini en aza indirir, taşıma ve elleçleme sırasında plakaların zarar görme ihtimalini azaltır; aynı zamanda konteyner kullanımını ve depo alanını optimize eder. Uzun süreli yeniden kullanım için tasarlanan bu sistemler, malzeme israfını ve çevresel etkiyi önemli ölçüde azaltır.

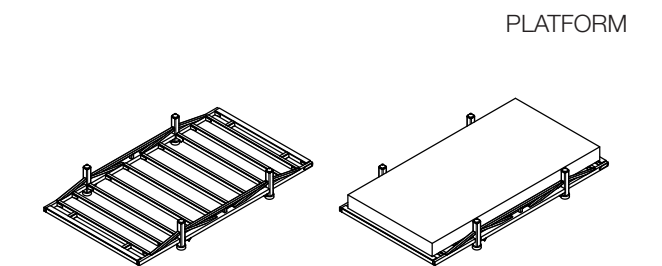
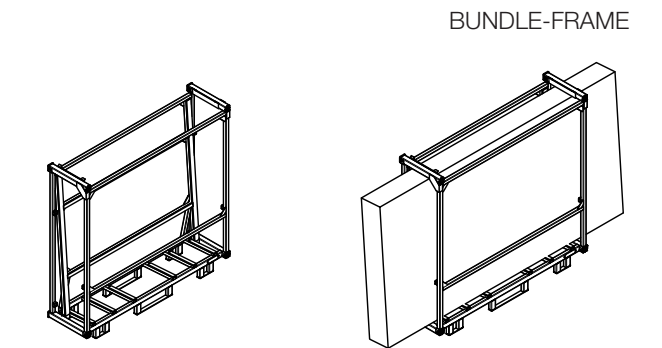
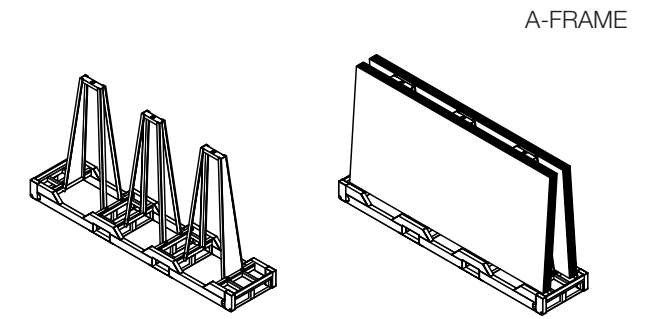

## Resources

<sup>EN</sup> Discover our thoughtfully curated library of resources, designed to bring your vision to life with precision and ease.

CARE & MAINTENANCE  
SAFETY DATA SHEETS  
INSTALLATION MANUAL  
MATERIAL HANDLING MANUAL  
AND MORE

To access all of the available resources, [www.anatolia.com](http://www.anatolia.com).

<sup>ES</sup> Descubra nuestra biblioteca de recursos cuidadosamente seleccionados, diseñados para hacer realidad su visión con precisión y facilidad.

CUIDADO Y MANTENIMIENTO  
FICHAS DE DATOS DE SEGURIDAD  
MANUAL DE INSTALACIÓN  
MANUAL DE MANIPULACIÓN DE MATERIALES  
Y MUCHO MÁS

Para acceder a todos los recursos disponibles, visite [www.anatolia.com](http://www.anatolia.com).



<sup>FR</sup> Découvrez notre bibliothèque de ressources soigneusement sélectionnées, conçues pour donner vie à votre vision avec précision et facilité.

ENTRETIEN ET MAINTENANCE  
FICHES DE DONNÉES DE SÉCURITÉ  
MANUEL D'INSTALLATION  
MANUEL DE MANIPULATION DES MATÉRIAUX  
ET PLUS

Pour accéder à toutes les ressources disponibles, rendez-vous sur [www.anatolia.com](http://www.anatolia.com).

<sup>TR</sup> Vizyonunuzu hassasiyet ve kolaylıkla hayata geçirmek için özenle hazırlanmış kaynak kütüphanemizi keşfedin.

BAKIM VE ONARIM  
GÜVENLİK BİLGİ FORMLARI  
KURULUM KILAVUZU  
MALZEME TAŞIMA KILAVUZU  
VE DAHA FAZLASI

Mevcut tüm kaynaklara erişmek için [www.anatolia.com](http://www.anatolia.com) adresini ziyaret edin.

## The World of Anatolia

*We are a constellation of people and places. Get in touch.*

CANADA  
TORONTO HEAD OFFICE,  
SHOWROOM AND DISTRIBUTION  
CENTER

8300 Huntington Road  
Vaughan, ON, L4H 4Z6  
Canada

TORONTO SINTERED  
SLABS DISTRIBUTION CENTER

700 Anatolian Drive  
Vaughan, ON L4H 5H7  
Canada

[info@anatolia.com](mailto:info@anatolia.com)

Tel: +1 905 771 3800  
Toll free tel: 1 877 311 3434  
Fax: +1 905 771 6300  
Fax: +1 866 324 1838

USA  
SAVANNAH OFFICE, SHOWROOM  
AND DISTRIBUTION CENTERS  
Anatolia (USA) Inc.  
Tel: +1 877 311 3434

SAVANNAH WAREHOUSE #1  
202 International Trade Pkwy  
Port Wentworth, GA, 31407  
USA  
Tel: +1 912 438 5167

SAVANNAH WAREHOUSE #2  
250 International Trade Pkwy  
Port Wentworth, GA, 31407  
USA  
Tel: +1 912 438 5167

TURKIYE  
IZMIR OFFICE, SHOWROOM,  
DISTRIBUTION CENTER, AND  
MANUFACTURING FACILITY

Aliağa Organize Sanayi Bölgesi  
Çoraklar Mah. 5000 Sk. No: 25  
35800 Aliağa, İzmir,  
Türkiye  
Tel: +90 232 520 7300

REGIONAL OFFICES  
CHINA  
Room 517 Yi Shu Da Lou Ji Hua 4 Road  
Chan Cheng District, Foshan City  
Guang Dong Province, 528000  
China

INDIA  
206 - Pacific Business Park  
Mahendra Nagar (Part)  
8/A - National High Way  
Morbi, Gujarat, 363642  
India

USA  
Anatolia (USA) Inc.  
131 Crosslake Park Dr., Suite 202  
Mooresville, NC, 28117  
USA  
Tel: +1 877 311 3434

### *Credits*

ART DIRECTION  
AND GRAPHIC DESIGN  
Juma

PHOTOGRAPHY  
Norman Wong, Page 6

### *Partnerships and Associations*

**idc**  
interior designers of canada  
designers d'intérieur du canada

TTMAC  ACTTM

AMERICAN  
SOCIETY OF  
INTERIOR  
DESIGNERS 

*Discover more at*  
anatolia.com

