



Cassette awning

markilux MX-3

The sturdy cassette awning with a slender figure and contrasting visual features from round to square.



01 Product characteristics

Wind resistance class 2
Beaufort 5 → 7.5-10.4 m/s → 28-37 km/h → 17-23 mph

02
03
04
05

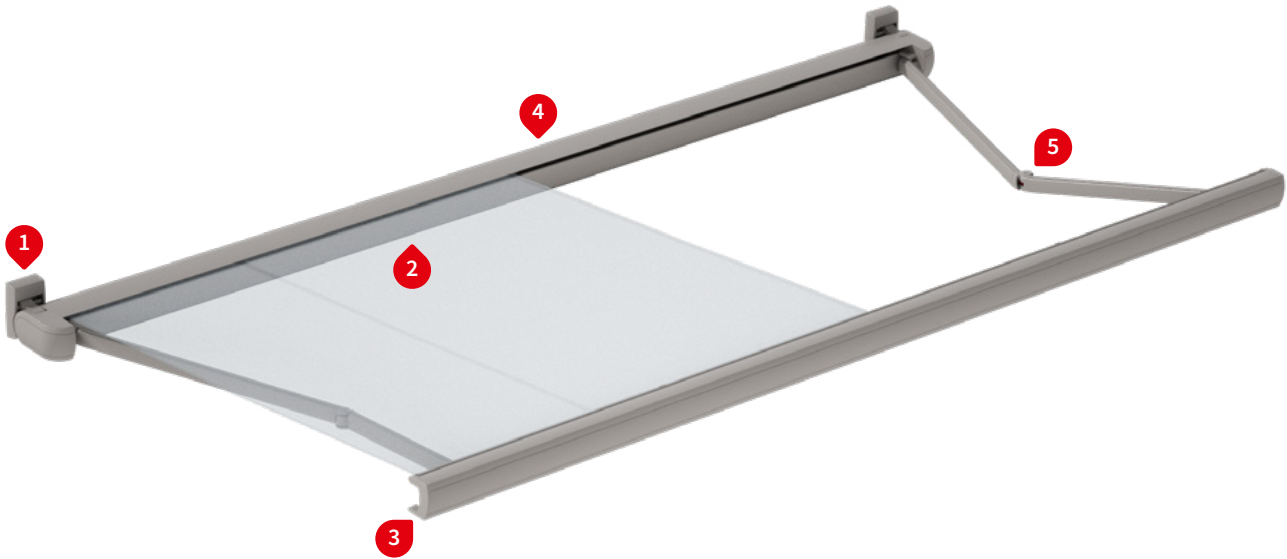

1 Face fixture

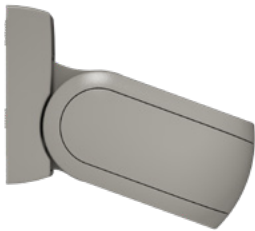

1 Face fixture, maximum pitch of 35°

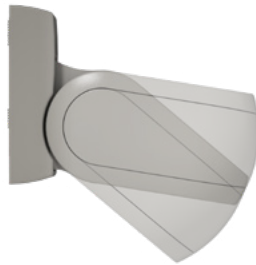

1 Top fixture

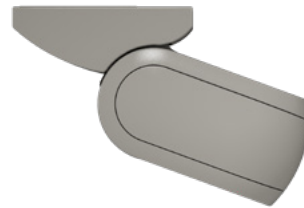

1 Top fixture, view from the rear



2 LED-Line recessed in the cassette ¹⁾

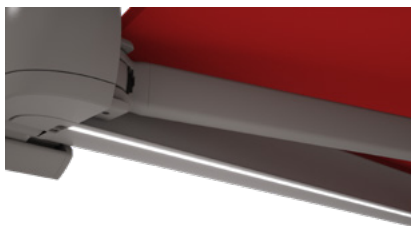

2 LED-Spots underneath the cassette ¹⁾



3 Unique water drainage system in the front profile

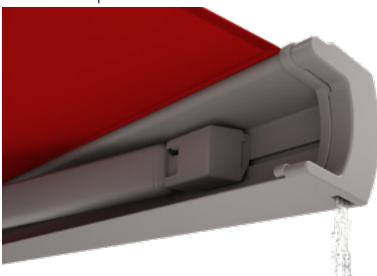

4 Wall sealing profile ¹⁾



5 Bionic tendon made of high-tech fibres for optimum power transference



1) optional configuration

Product characteristics

Description

- a slender, folding-arm full cassette awning exhibiting excellent technological features, which enables areas up to 6 m wide to be shaded.

Special features

- self-supporting cassette profile with the brackets installed at each end of the awning – therefore suitable for bridging larger distances
- cassette with arms situated in front and at each end, which – when the awning is closed – are encompassed fully by the front profile lending a harmonious overall appearance to the awning
- the cassette obscures the view of the roller tube when the awning is extended
- option of directional LED-Line fitted to the underside of the cassette which provide an appealing atmosphere in the evening
- various screen profile and awning colours can be combined
- screen profile also available with exclusive coating in the “Selection MX colour selection” the brackets are hidden unobtrusively behind the awning

Dimensions

- cassette in the standard version: depth 230 mm, height 120 mm
- single unit: minimum width 183 cm at the smallest projection of 150 cm, maximum width 500 cm at the largest projection of 350 cm or 600 cm at a maximum projection of 300 cm

Roller tube and lateral bearings

- round roller tube Ø 85 mm with keyway, galvanised steel – excellent stability, ensures near perfect cover performance even at the largest widths
- the arm bearer is made of die-cast aluminium, powder coated, with integrated, infinitely variable pitch setting-mechanism

Awning profiles

- extruded aluminium, in façade quality, powder coated
- two-piece cassette with clever inner profile – providing the awning cover with optimum protection against the elements
- the lower cassette profile has a slot into which the LED Line can be recessed
- front profile, harmoniously rounded at the front with integrated gutter

Folding arms

- profiles in extruded aluminium, in façade quality, powder coated
- moving parts made of drop-forged aluminium – the arms are therefore extremely fracture resistant
- pivot bolts in stainless steel run in Teflon-coated bronze bushes - practically maintenance free, virtually silent and extremely hard wearing
- power transference via the innovative bionic tendon at the elbow joint, made of high tensile, high-tech fibres – low in friction, noiseless, insensitive to corrosion and UV resistant

Side caps

- the end cap insert sections are made of high-quality plastic, powder coated or in a polished chrome finish
- the front profile end caps are made of high-quality plastic, powder coated, with water drainage holes

Fixture brackets

- face fixture, top fixture, eaves fixture
- extruded aluminium, powder coated
- also available in individual widths (on request)
- including caps made of high quality plastic to cover the face or top fixture brackets and their fixture bolts
- pitch range 5°–35° (face fixture) or 5°–70° (top or eaves fixture), infinitely variable
- spacer plates, stand-off brackets and other accessories are available

01 Frame, end cap insert and styling panel colours

markilux awning colours without surcharge

02
03
04
05

traffic white, RAL 9016



metallic aluminium, RAL 9006



off-white textured finish, 5233 ¹⁾



stone grey metallic, 5215 ¹⁾



anthracite metallic, 5204 ¹⁾



Havana brown textured finish, 5229 ¹⁾



Non-standard powder-coated finish

Bespoke frame colours incur a surcharge – matt, metallic, finely textured and pearl finishes as well as other colour ranges (DB, Tiger etc.) on request. All frame colours are available at a surcharge with enhanced corrosion protection.

¹⁾ textured finish

Combination Possibilities

All standard styling panel colours can be combined at will with the standard frame colours ²⁾

Frame stone grey metallic, 5215

Styling panel / end cap insert anthracite metallic, 5204



Frame off-white textured finish, 5233

Styling panel / end cap insert anthracite metallic, 5204



Frame traffic white, RAL 9016

Styling panel / end cap insert metallic aluminium, RAL 9006



Frame anthracite metallic, 5204

Styling panel / end cap insert stone grey metallic, 5215



²⁾ depictions by way of example; The styling panel and end cap insert colours must be the same colour. Colours may differ slightly from those depicted in both hue and finish.

Additional styling panel and end cap insert colours

The additional styling panel colours can be combined at will with all the standard frame colours ¹⁾

Styling panel / end cap insert yellow green, RAL 6018
Frame anthracite metallic, 5204
Awning cover 325 06

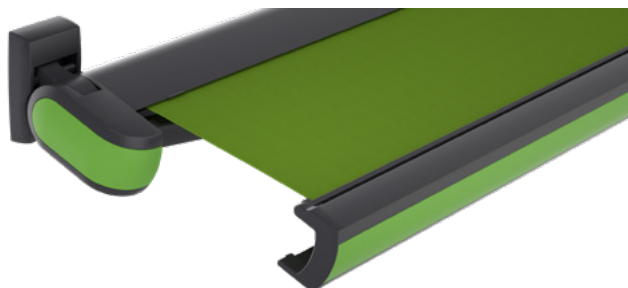

Styling panel / end cap insert sulphur yellow, RAL 1016
Frame stone grey metallic, 5215
Awning cover 324 71

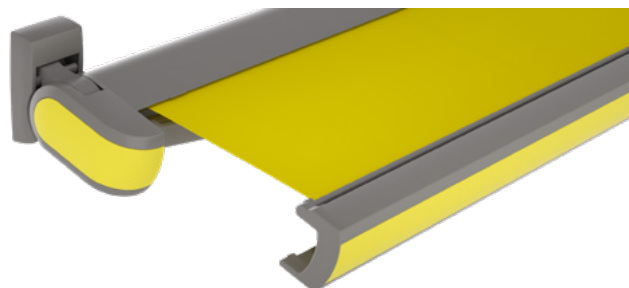

Styling panel / end cap insert red orange, RAL 2001
Frame Havana brown textured finish, 5229
Awning cover 309 12

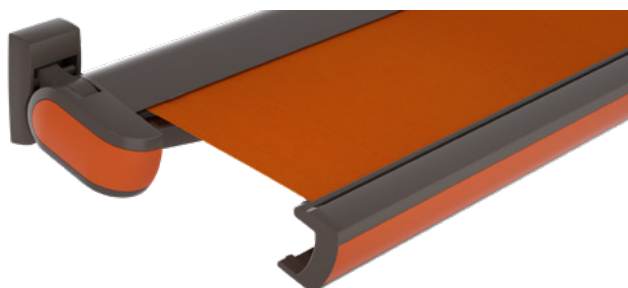

Styling panel / end cap insert traffic red, RAL 3020
Frame anthracite metallic, 5204
Awning cover 310 03

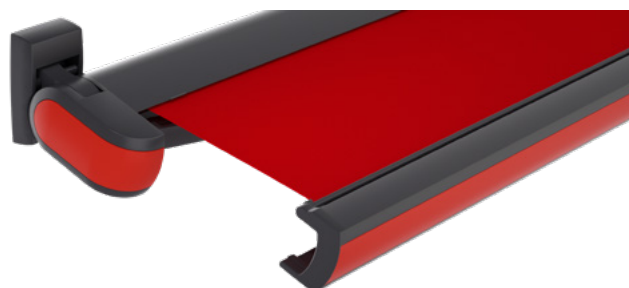

Styling panel / end cap insert purple violet, RAL 4007
Frame anthracite metallic, 5204
Awning cover 310 54

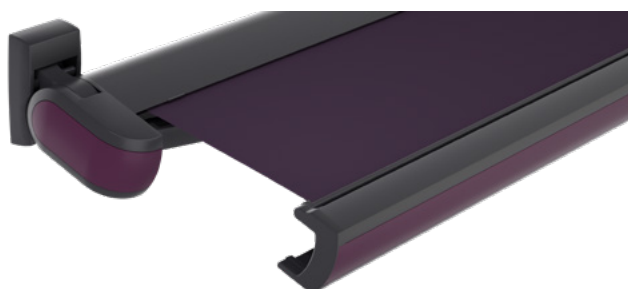

Styling panel / end cap insert pearl white, RAL 1013
Frame off-white textured finish, 5233
Awning cover 309 37



Styling panel / end cap insert pearl mouse grey, RAL 7048
Frame Havana brown textured finish, 5229
Awning cover 314 87

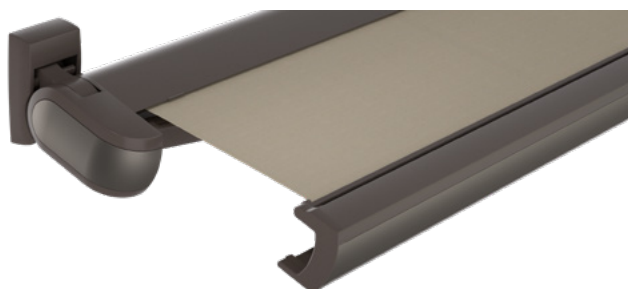

Styling panel / end cap insert agate grey, RAL 7038
Frame stone grey metallic, 5215
Awning cover 315 92

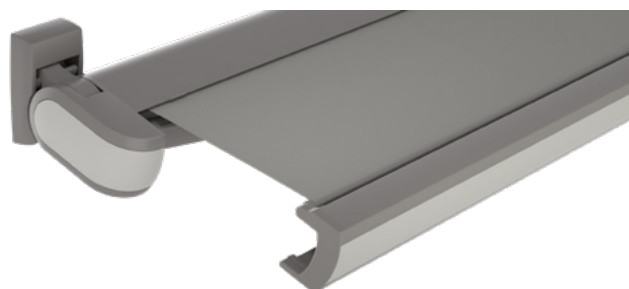

¹⁾ depictions by way of example; The fabric and styling panel in a matching colour; styling panel and end cap insert colours must be the same colour. Colours may differ slightly from those depicted in both hue and finish.

01
02
03
04
05

01 Additional Selection MX front panel colours

Recommended colour combinations²⁾

02
03
04
05

SMX-01 Copper green with patina
Frame Anthracite metallic 5204
Awning cover 310 58



SMX-02 Brass with dark patina
Frame Off-white textured finish 5233
Awning cover 324 49

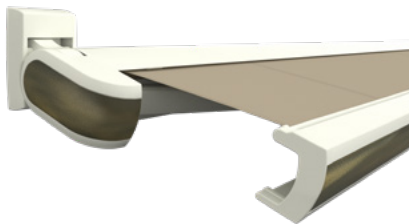

SMX-03 Bronze dark-patinated
Frame Havana brown textured finish 5229
Awning cover 309 47



SMX-04 Matt black / silver effect lacquer
Frame Anthracite metallic 5204
Awning cover 310 28



SMX-05 Matt white/silver effect lacquer
Frame Off-white textured finish 5233
Awning cover 310 09



SMX-06 Silver grey special effect lacquer
Frame Stone grey metallic 5215
Awning cover 310 18



SMX-07 Amber orange metallic matt
Frame Havana brown textured finish 5229
Awning cover 314 83

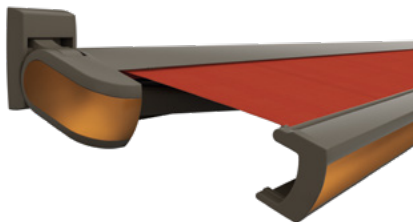

SMX-08 Pebble beige metallic matt
Frame Off-white textured finish 5233
Awning cover 314 87

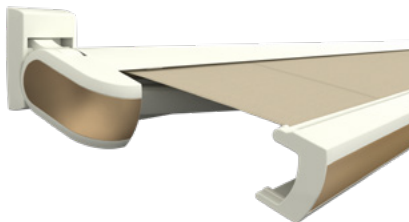

SMX-09 Ruby red metallic matt
Frame Anthracite metallic 5204
Awning cover 325 13



SMX-10 Emerald green metallic matt
Frame Havana brown textured finish 5229
Awning cover 325 16

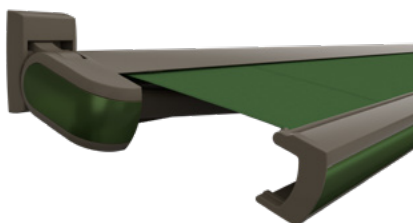

Notes with regard to selecting colours from the markilux Selection MX range

Every front panel finished in a coating from the Selection MX range is unique. In a complex procedure, an exclusive look is created by using several layers of lacquer. During this process, the resulting colour and colour texture are influenced by different factors.

For technical reasons, a slight two-tone effect, variations in the degree of gloss and colour hue as well as small variations in colour between subsequent coats of paint in the same tone may be in evidence. The colour texture is always unique, particularly in the case of multi-layered coatings.

The compound colour tone SMX-10 Emerald green metallic is an interference colour, which has an iridescent effect depending on the light incidence and the viewing angle.



You are free to combine any Selection MX front panel colour with any frame colour.

²⁾ Illustrations by way of example; The styling panel and end cap insert colours must be the same colour. Colours may differ slightly from those depicted in both hue and finish.

Dimensions and configuration options

01
02
03
04
05

Single unit

		Awning width							Minimum widths		
		250	300	350	400	450	500	550	600	Motor	Crank handle
Order dimensions		183	251	301	351	401	451	501	551		
		250	300	350	400	450	500	550	600		
H	150	1)								191	183
	200	1)								233	233
	250	—	1)							283	283
	300	—	—	1)						333	333
	350	—	—	—	1)			—	—	383	383

dimensions in cm

1) = please note the minimum widths!

H = projection

 = 2 folding arms, 2 brackets

 = 2 standard arms

Operation

	standard	optional
manual operation	✓	—
spring-assisted crank handle	—	✓
hard-wired motor	—	✓
silentec motor (optionally with an external io / RTS receiver)	—	—
radio-controlled motor io, 868 MHz	—	✓
radio-controlled motor RTS, 433 MHz	—	✓
radio-controlled motor RTS, 433 MHz with manual override	—	—

Coupled Awning

not available

Awning cover

	fabric range no.	standard	optional
sunvas	301.. / 309..-315..	✓	—
perla	370 ..	—	✓
sunsilk	324.. / 325.. / 328.. / 369..	✓	—
perla FR	374.. / 375..	—	✓
perfortex	331.. / 332..	—	—
transolair	338.. / 339 ..	—	—
vuscreen Alu	317..	—	—
Soltis Perform 92	92-20..	—	—
glass fibre screen	272..	—	—
valance		—	—

Shadeplus / drop valance

not available

01

Optional accessories

LED-Line recessed in the cassette
LED-Spots underneath the cassette
wall sealing profile, up to a maximum awning pitch of 35°
infrared heater 2500 W
infrared heater 2500 W with integrated radio-controlled receiver, 868 MHz io
automatic controls (light, wind, rain)

02

03

04

05

N.B! Important background information can be found in the chapter "Optional Accessories".

Fixture options

face fixture bracket with cover, left 100 mm	75885.
face fixture bracket with cover, right 100 mm	75886.
face fixture bracket left 300 mm	75877.
face fixture bracket right 300 mm	75878.
spreader plate A 430 × 160 × 12 mm	75326.
spreader plate B 300 × 400 × 12 mm	75325.
markilux panel 250 × 230 × 49 mm	76308.
markilux panel continuous	76380.
stand-off bracket 80–300 mm for face fixture bracket 100 mm	72872.
stand-off bracket 80–300 mm for face fixture bracket 300 mm	77968.
top fixture bracket with cover, left 100 mm	75887.
top fixture bracket with cover, right 100 mm	75888.
eaves fixture bracket 90 mm, 150 mm plate	75889.
eaves fixture bracket 90 mm, 270 mm plate	71659.
flat plate and angled bracket for eaves fixture, machine finish aluminium, 500 mm plate	716620
spreader plate 260 × 60 × 12 mm for eaves fixture bracket	75383.

Lighting options

LED-Line recessed in the cassette

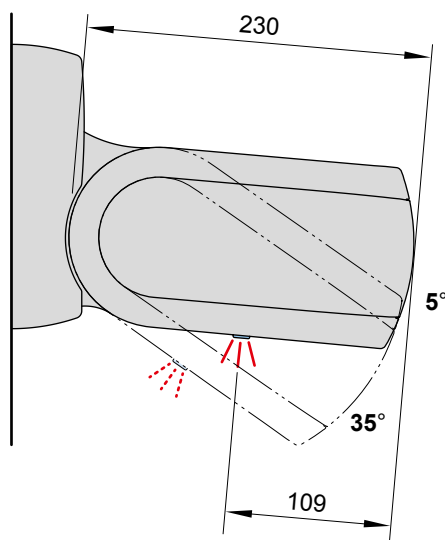

dimensions in mm

Technical specification

Operating voltage	230 V, 50 Hz
power output per metre	10 W / metre
number of LEDs per metre	120 LEDs/ metre
Light source	LED (12 V)
Number of transformers	1 unit
Light temperature	warm white
IP protection class	IP 44
Service life	approx. 15.000 h

Controls

	Standard	Optional
radio-controlled dimmer io, 868 MHz	✓	—
radio-controlled dimmer RTS, 433 MHz	✓	—

Electrical connection

power supply cable H05RN-F 3G1
(3 × 1 mm²) with open end

Lighting options

Directional LED spotlights underneath the cassette

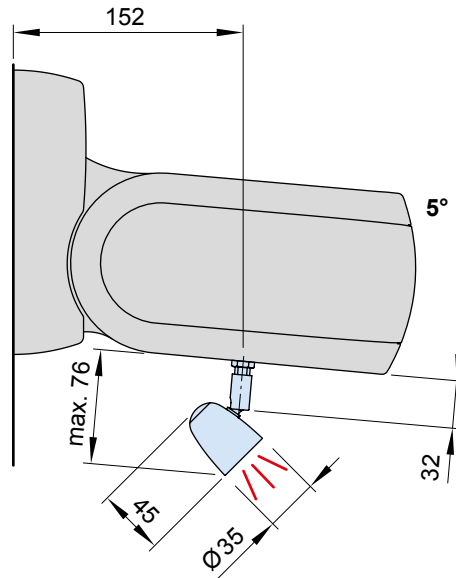

dimensions in mm

Technical specification

Operating voltage	230 V, 50 Hz
power output per metre	5 W
Light source	LED (12 V)
Number of transformers	1 unit
Light temperature	warm white
IP protection class	IP 44
Service life	approx. 20.000 h

Controls

	Standard	Optional
Radio-controlled dimmer io, 868 MHz	✓	—
Radio-controlled dimmer RTS, 433 MHz	✓	—

Electrical connection

power supply cable H05RN-F 3G1
(3 × 1 mm²) with open end

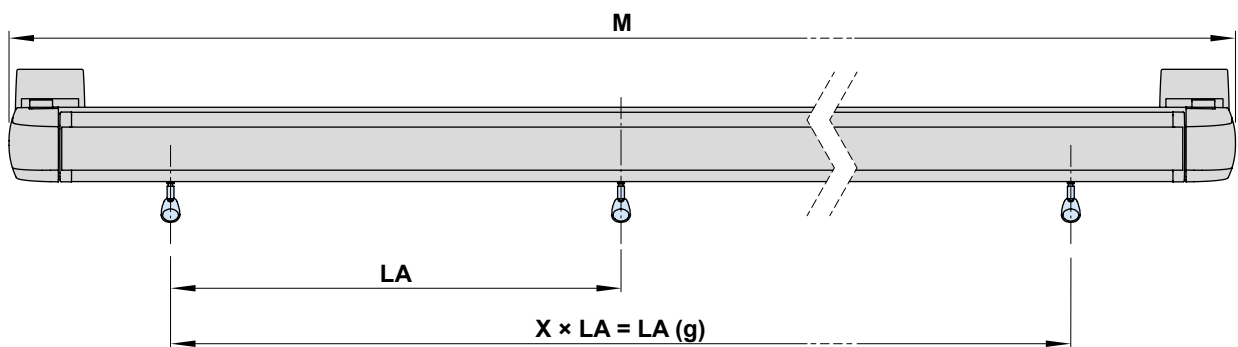

awning width	no. of spotlights	LA	LA (g)
195-250	3	75	150
251-300	3	98	196
301-350	3	98	196
351-400	4	98	294
401-450	4	98	294
451-500	5	98	392
501-550	5	98	392
551-600	6	98	490

LA (g) = distance between the spotlights (total)
M = order dimension = awning width
X = number of distances between the spots
 (depends on size)

dimensions in cm

01 No of brackets | No. of fixing points

02

03

04

05

		Awning width							
		250	300	350	400	450	500	550	600
Order dimensions		195	251	301	351	401	451	501	551
		250	300	350	400	450	500	550	600
BHT		No of brackets No. of fixing points							
W	10	2 6							
BP		A 2 16 B 2 8							
PA		2 8							
DA / DE	10	2 8							

dimensions in cm

The **pull-out forces** necessary for determining the correct fixing materials necessary to meet wind resistance class 2 (Beaufort 5) can be found in the password-protected dealer area of the markilux.com website under "Pull-out Forces".

BHT = bracket width

BP = spreader plate (A / B)

DA = eaves fixture bracket

DE = top fixture

PA = markilux panel, fixture profile, width 250 mm

GB = top fixture bracket

W = face fixture bracket

Bracket fixture range

01
02
03
04
05

Face and top fixture

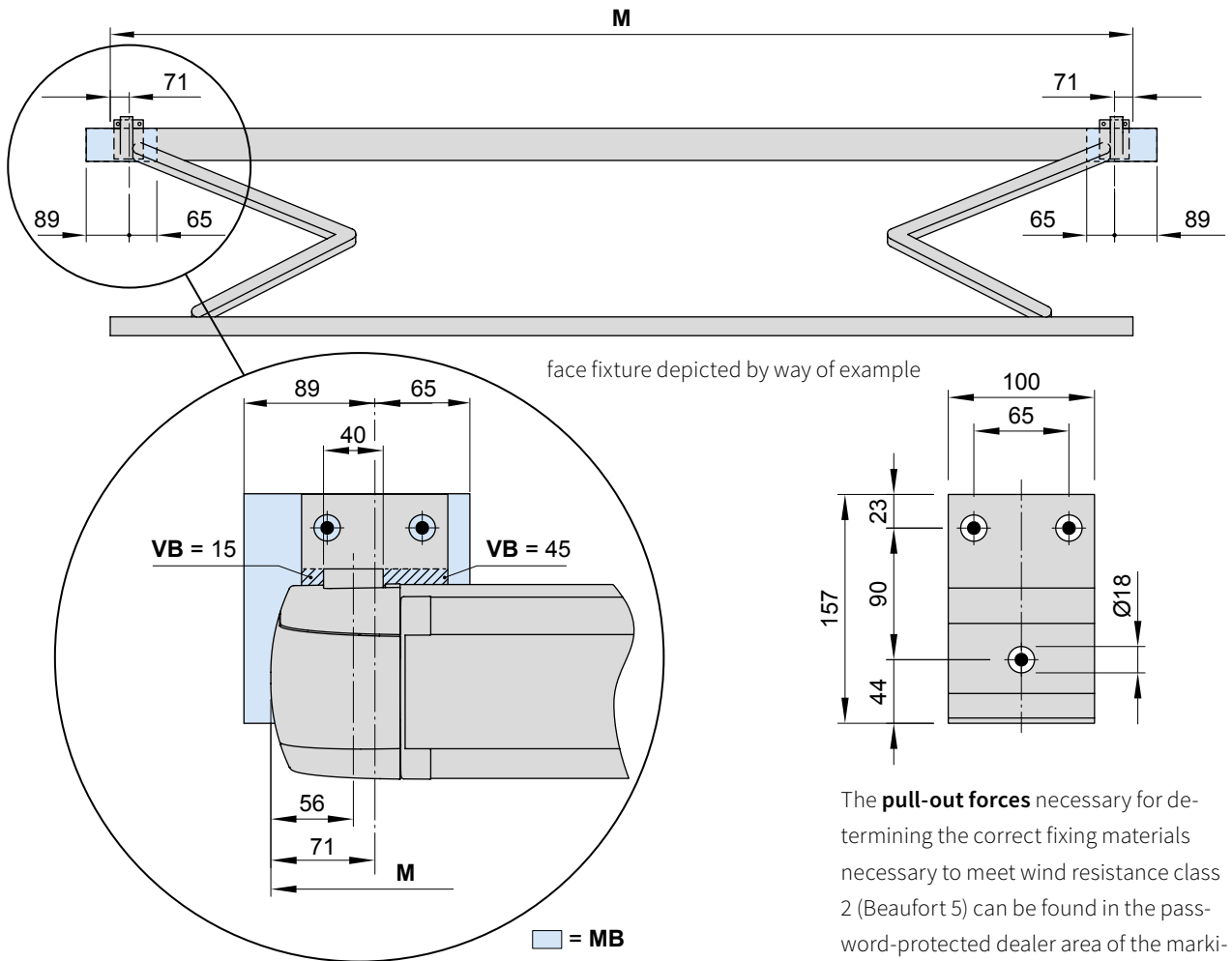

The **pull-out forces** necessary for determining the correct fixing materials necessary to meet wind resistance class 2 (Beaufort 5) can be found in the password-protected dealer area of the markilux.com website under "Pull-out Forces".

Eaves fixture

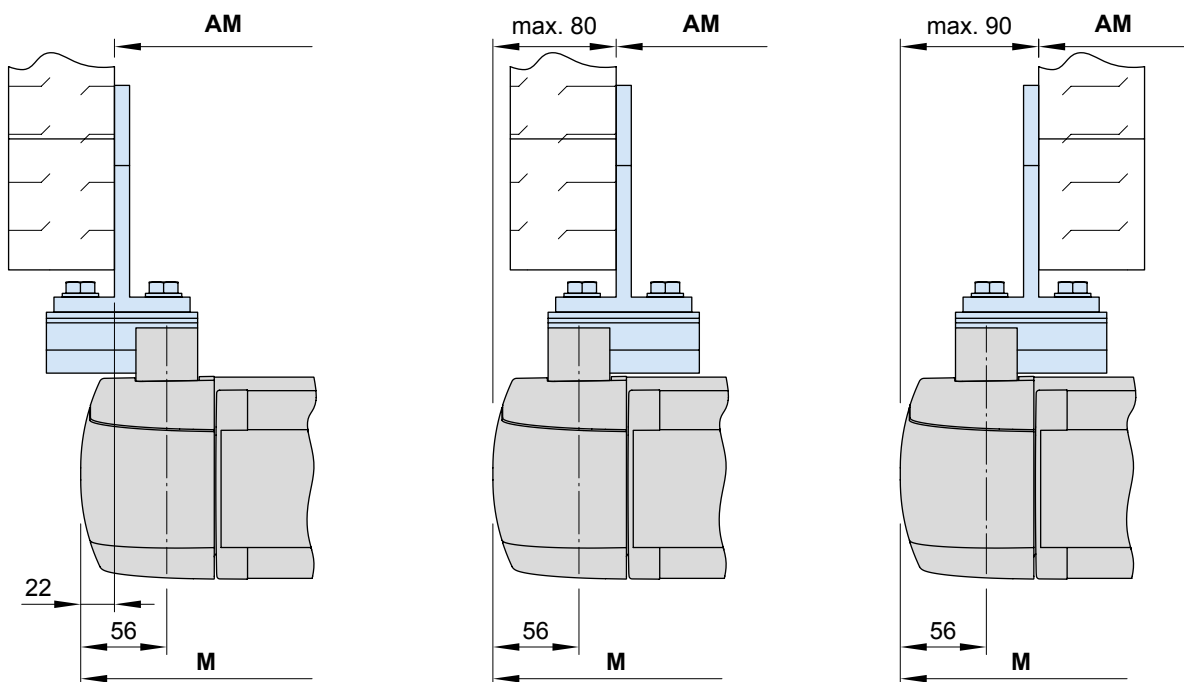

M = order width = awning width
MB = bracket fixture range

VB = adjustment range face fixture bracket
AM = installation dimensions
dimensions in mm

01 Face fixture

Fixtures, fittings and accessories

02
03
04
05

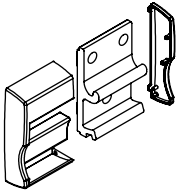

face fixture bracket cover cap
left
100 mm

75885.

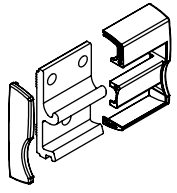

face fixture bracket cover cap
right
100 mm

75886.

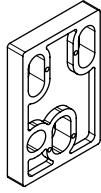

spacer plate
100 × 150 × 20 mm
N.B!
Stack to a max. height of 200 mm

758831

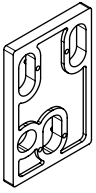

spacer plate
100 × 150 × 12 mm

758841

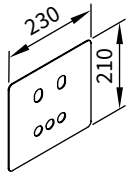

cover plate for spacer plate and stand-off brackets in the case of external insulation
230 × 210 × 2 mm

71843.

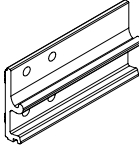

face fixture bracket left
300 mm

75877.

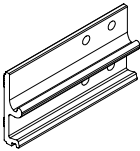

face fixture bracket right
300 mm

75878.

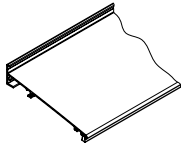

wall sealing profile incl. brush seal
by the metre

76385. and 704241



1 side plate including 2 pan-head self-tapping screws for wall sealing profile

76386. and 2 × 735611

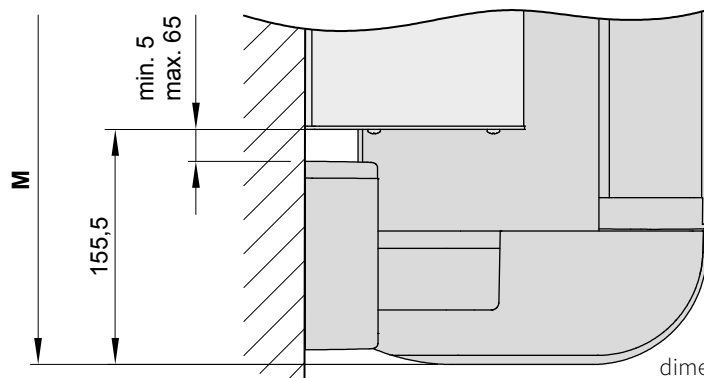
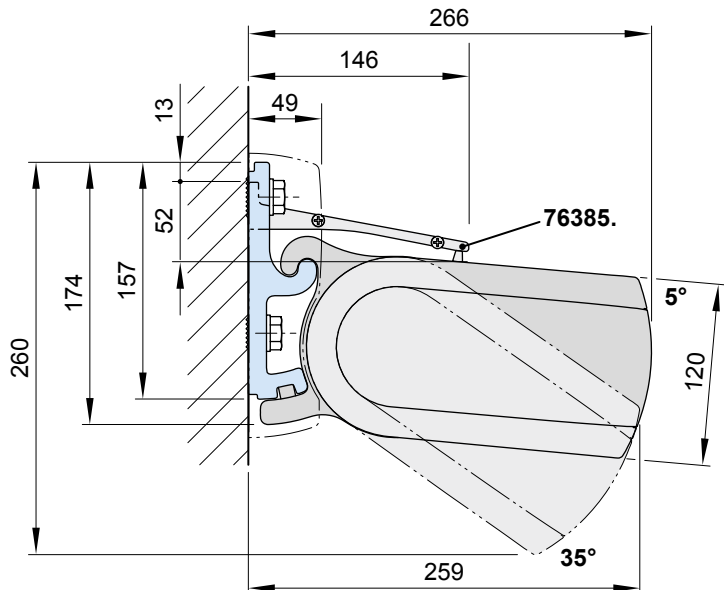
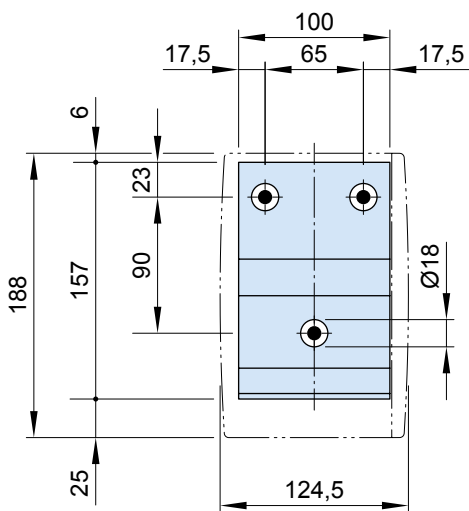

76385. = wall sealing profile (standard width = awning width (M) – 311 mm; up to a maximum awning pitch of 35°)
M = order width = awning width

dimensions in mm

Face fixture with spreader plate A

Fixtures, fittings and accessories

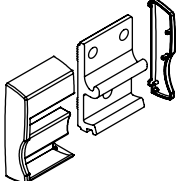

face fixture bracket cover cap
left
100 mm

75885.

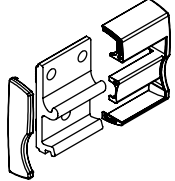

face fixture bracket cover cap
right
100 mm

75886.

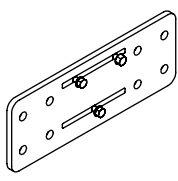

spreader plate A
face fixture
430 × 160 × 12 mm

73466.

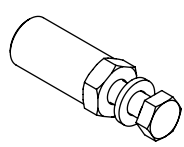

bolt reduction assembly
pack 10 pcs

M 16 → M 12 | M 16 → M 10 | M 12 → M 10 | M 10 → M 10

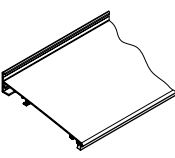

wall sealing profile incl. brush seal
by the metre

76385. and 704241

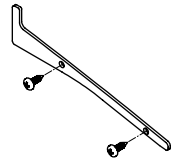

1 side plate including 2 pan-head self-tapping screws for wall sealing profile

76386. and 2 × 735611

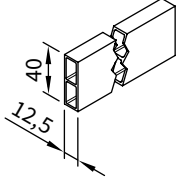

stand-off strip for wall sealing profile
available by the metre

40
12,5

751971

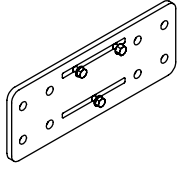

spreader plate A
430 × 160 × 12 mm

75326.

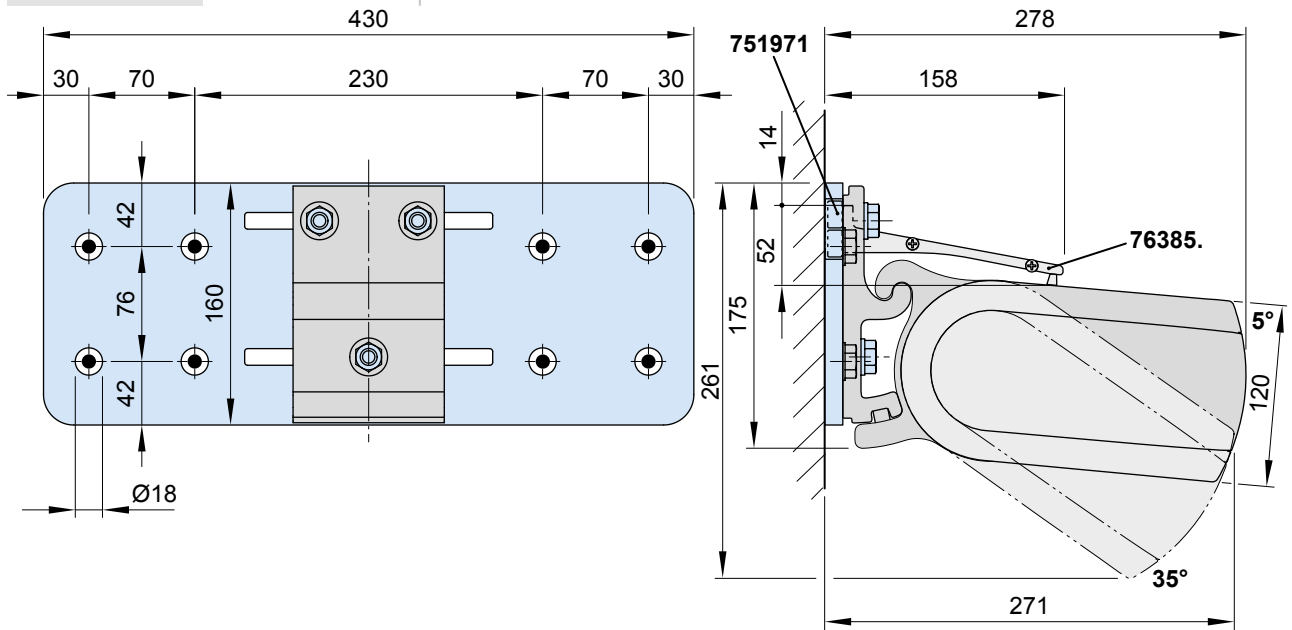

- 751971** = stand-off strip for wall sealing profile
- 76385.** = wall sealing profile (standard width = awning width **(M)** - 311 mm; up to a maximum awning pitch of 35°)
- M** = *order width* = awning width

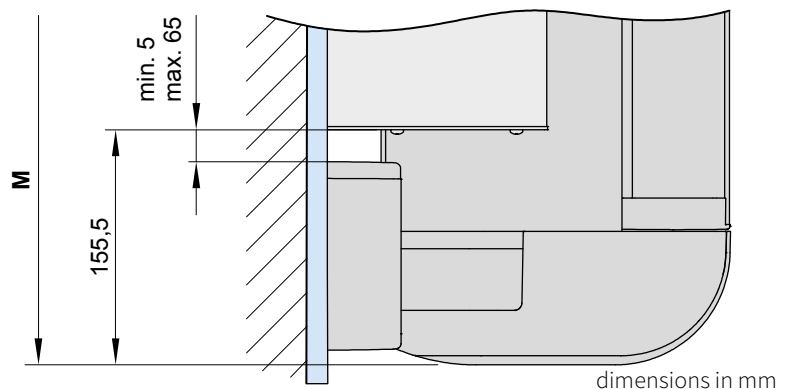

01
02
03
04
05

01 Face fixture with spreader plate B

Fixtures, fittings and accessories

02
03
04
05

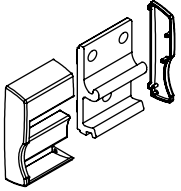

face fixture bracket cover cap
left
100 mm

75885.

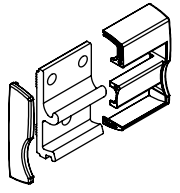

face fixture bracket cover cap
right
100 mm

75886.

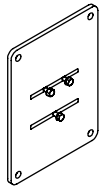

spreader plate B
face fixture
300 x 400 x 12 mm

753465

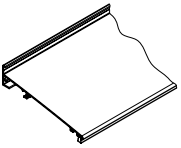

wall sealing profile incl. brush seal
by the metre

76385. and 704241

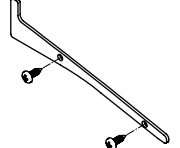

1 side plate including 2 pan-head self-tapping screws for wall sealing profile

76386. and 2 x 735611

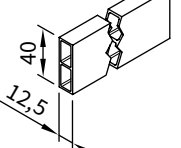

stand-off strip for wall sealing profile
available by the metre

751971

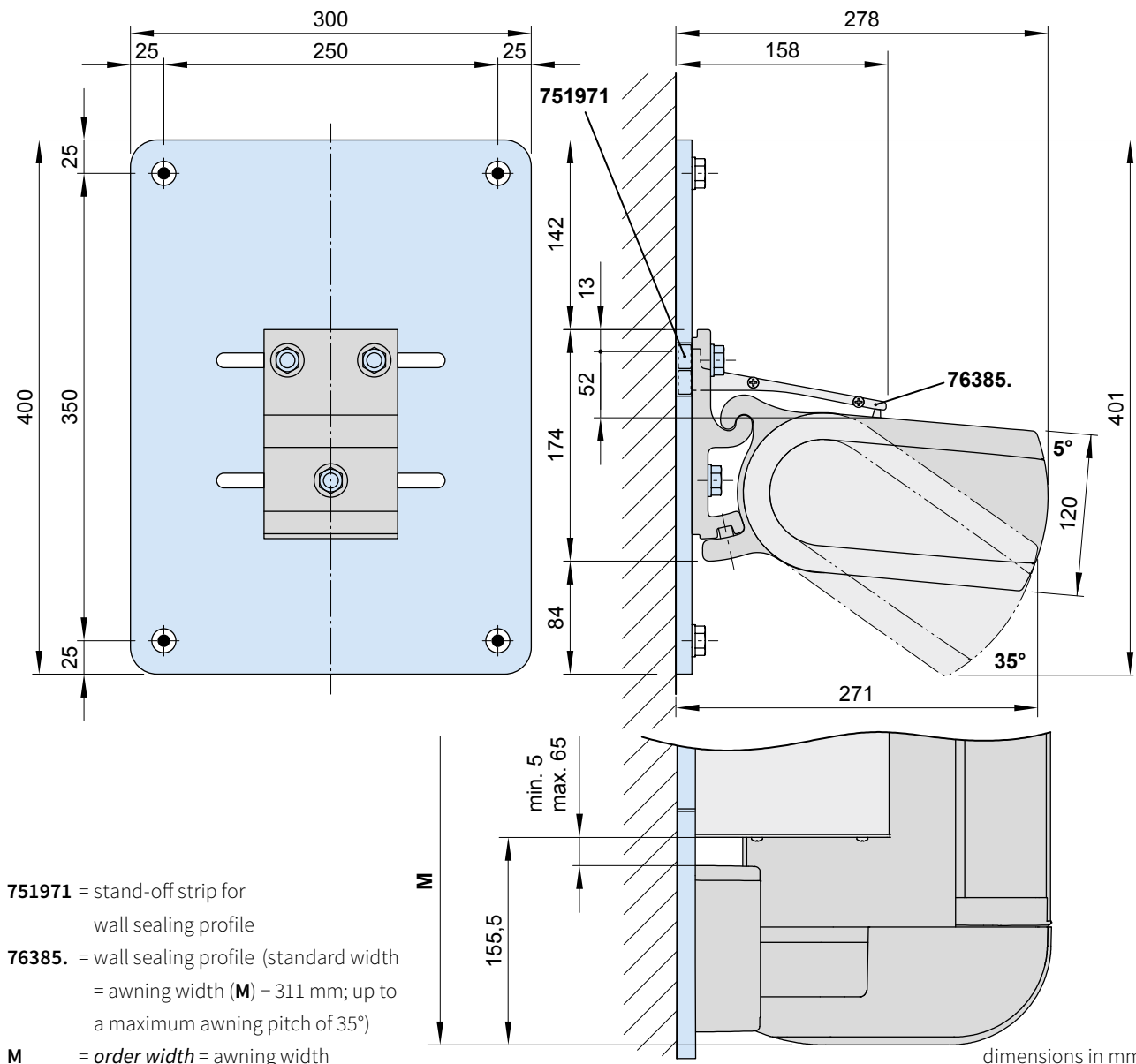

751971 = stand-off strip for wall sealing profile

76385. = wall sealing profile (standard width = awning width (M) - 311 mm; up to a maximum awning pitch of 35°)

M = *order width* = awning width

Face fixture with markilux panel 250 mm

Fixtures, fittings and accessories

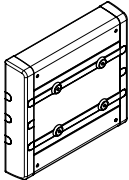

markilux panel fixture profile,
with decorative profiles and end caps
250 × 230 × 49 mm

76308.

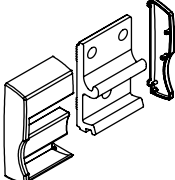

face fixture bracket cover cap
left
100 mm

75885.

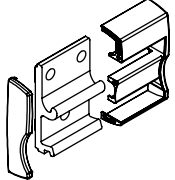

face fixture bracket cover cap
right
100 mm

75886.

- 01
- 02
- 03
- 04
- 05

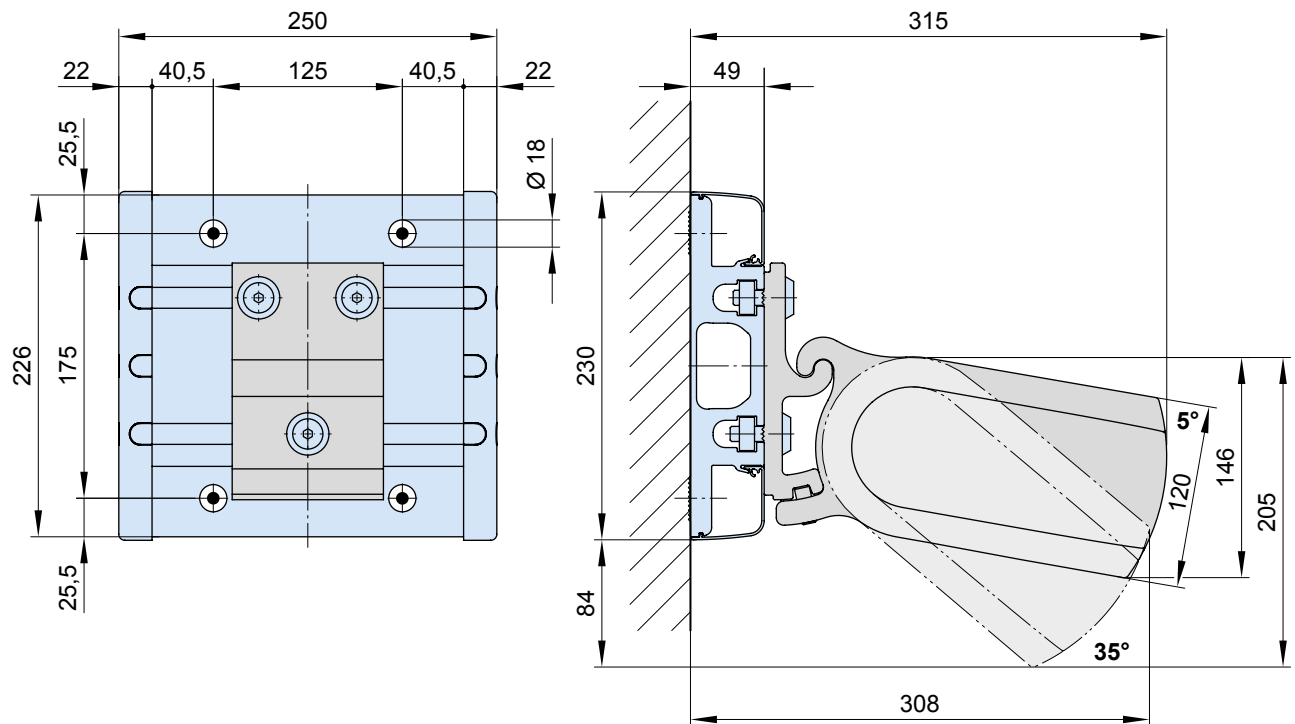

dimensions in mm

01 Face fixture with markilux panel continuous

Befestigung und Zubehör

02
03
04
05

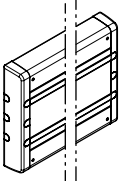

markilux panel fixture profile,
with decorative profiles and end caps
continuous

76380.

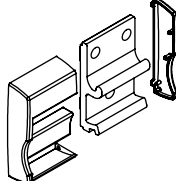

face fixture bracket cover cap
left
100 mm

75885.

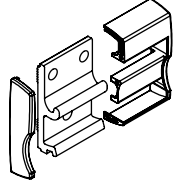

face fixture bracket cover cap
right
100 mm

75886.

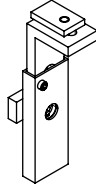

bracket wall sealing profile
small

76468.



wall sealing profile incl. brush seal
by the metre

76385. und 704241



1 side plate including 2 pan-head self-tapping screws for wall sealing profile

76386. und 2 x 735611

As a **continuous fixture profile**, the markilux panel will always be supplied to order on the basis of a technical drawing prepared in the factory in accordance with the awning specification.

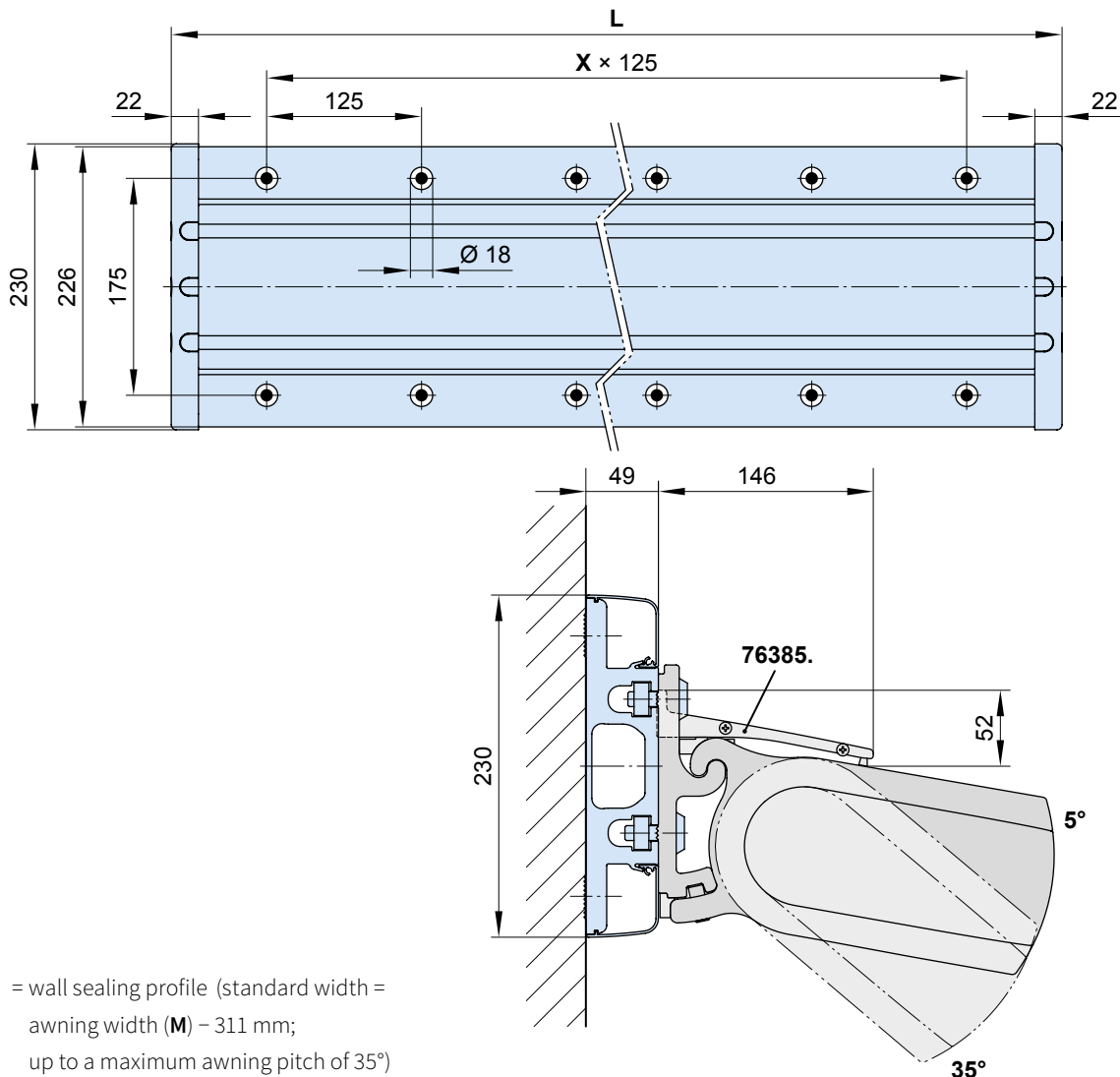

76385. = wall sealing profile (standard width = awning width (M) – 311 mm; up to a maximum awning pitch of 35°)

L = maximum width 7000 mm (standard $L = M + 20$ mm)

X = fixing point separation, **by way of example**

dimensions in mm

Face fixture with stand-off bracket

Fixtures, fittings and accessories

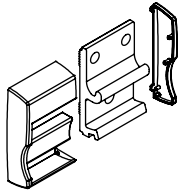
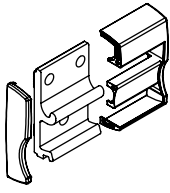
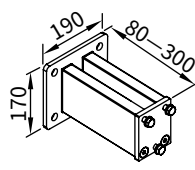
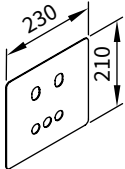
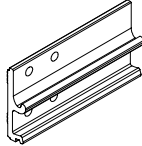
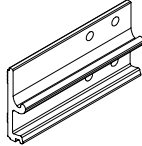
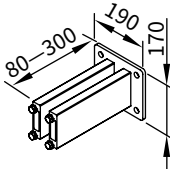
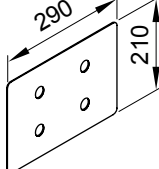
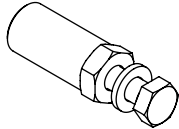
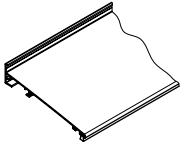
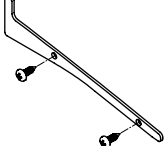
 <p>face fixture bracket cover cap left 100 mm</p> <p>75885.</p>	 <p>face fixture bracket cover cap right 100 mm</p> <p>75886.</p>	 <p>stand-off bracket for 100 mm face fixture brackets 75885. and 75886.</p> <p>72872.</p>
 <p>cover plate for spacer plate and stand-off bracket 72872. in the case of external insulation</p> <p>230 × 210 × 2 mm</p> <p>71843.</p>	 <p>face fixture bracket left 300 mm</p> <p>75877.</p>	 <p>face fixture bracket right 300 mm</p> <p>75878.</p>
 <p>stand-off bracket for 300 mm face fixture brackets 75877. and 75878.</p> <p>77968.</p>	 <p>cover plate for spacer plate and stand-off bracket 77968. in the case of external insulation</p> <p>290 × 210 × 2 mm</p> <p>71841.</p>	 <p>bolt reduction assembly pack 10 pcs</p> <p>M 16 → M 12 M 16 → M 10 M 12 → M 10 M 10 → M 10</p>
 <p>Wall sealing profile incl. brush seal when installing with a coverboard available by the metre</p> <p>76385. and 704241</p>	 <p>1 side plate including 2 pan-head self-tapping screws for wall sealing profile</p> <p>76386. and 2 × 735611</p>	

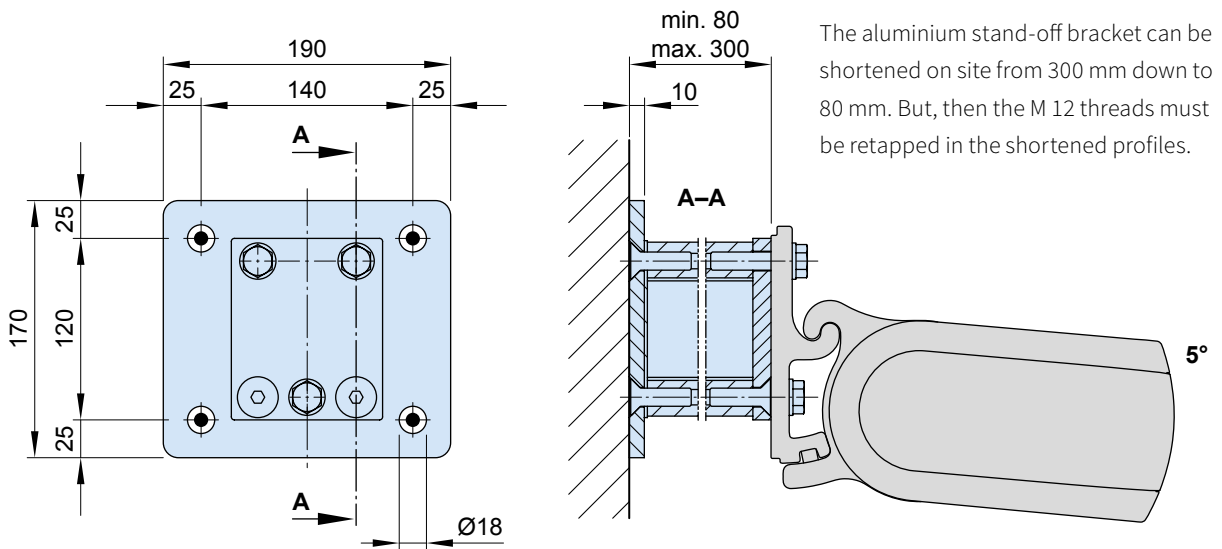

dimensions in mm

01 Top fixture

Fixtures, fittings and accessories

02
03
04
05

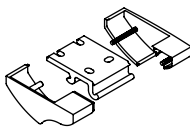

top fixture bracket cover cap
left
100 mm

75887.

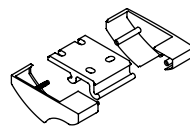

top fixture bracket cover cap
right
100 mm

75888.

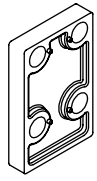

spacer plate
90 × 140 × 20 mm
N.B!
Stack to a max. height of 200 mm

716311

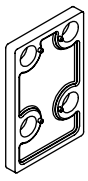

spacer plate
90 × 140 × 12 mm

716411

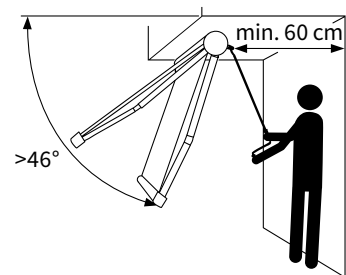
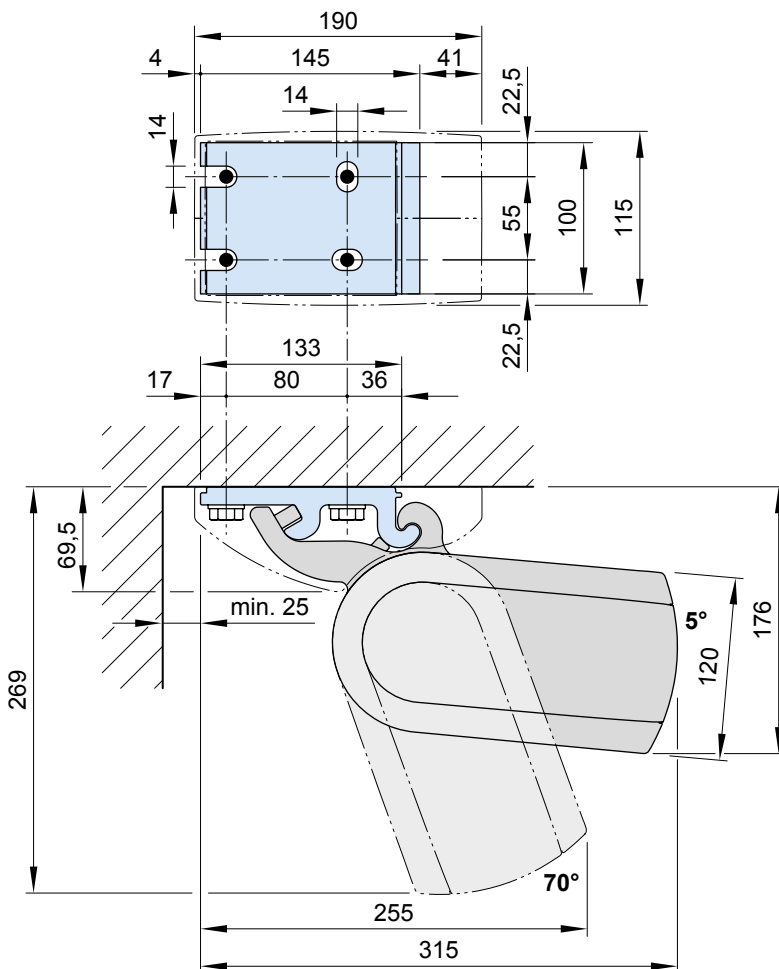

N.B! At a pitch of more than 46° to the horizontal there must be an area accessible behind the awning at least 60 cm deep to allow operation of an RTS motor with manual override.

dimensions in mm

Eaves fixture

Fixtures, fittings and accessories

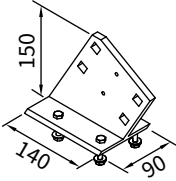

eaves fixture bracket
height of flat plate:
150 mm

75889.

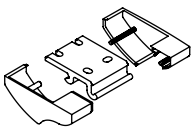

top fixture bracket
cover cap
left
100 mm

75887.

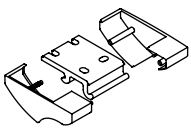

top fixture bracket
cover cap
right
100 mm

75888.

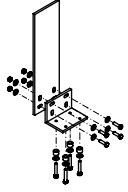

flat plate and angled
bracket for eaves fixture
height of flat plate:
500 mm
machine finish

716620

With eaves fixture bracket, top flat plate 150 mm (75889.)

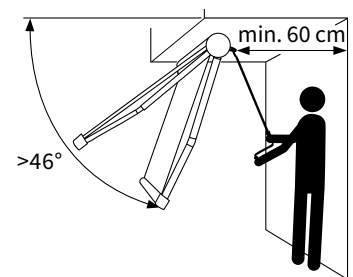
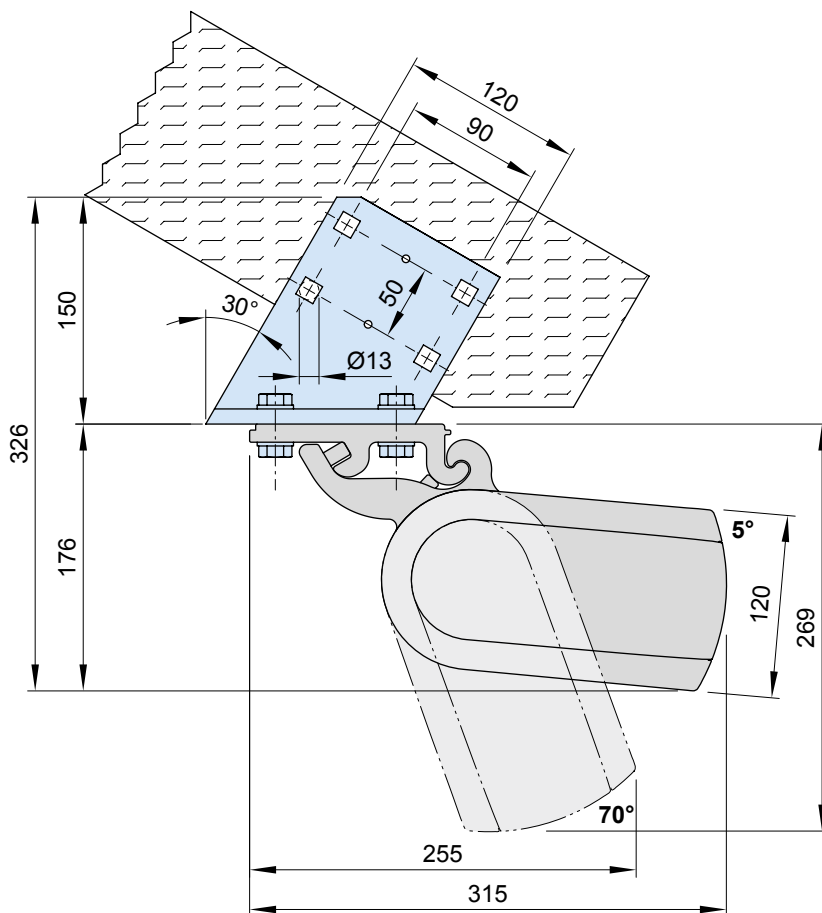

N.B! At a pitch of more than 46° to the horizontal there must be an area accessible behind the awning at least 60 cm deep to allow operation of an RTS motor with manual override.

dimensions in mm

01 Eaves fixture

Fixtures, fittings and accessories

02
03
04
05

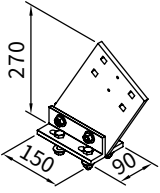

eaves fixture bracket
height of flat plate:
270 mm

71659.

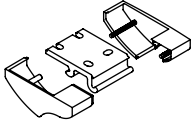

top fixture bracket
cover cap
left
100 mm

75887.

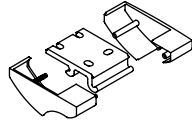

top fixture bracket
cover cap
right
100 mm

75888.

With eaves fixture bracket, top flat plate 270 mm (71659.)

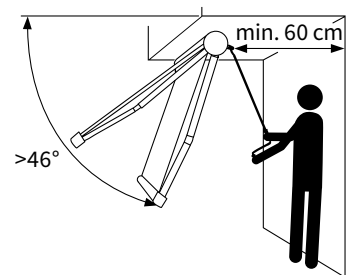
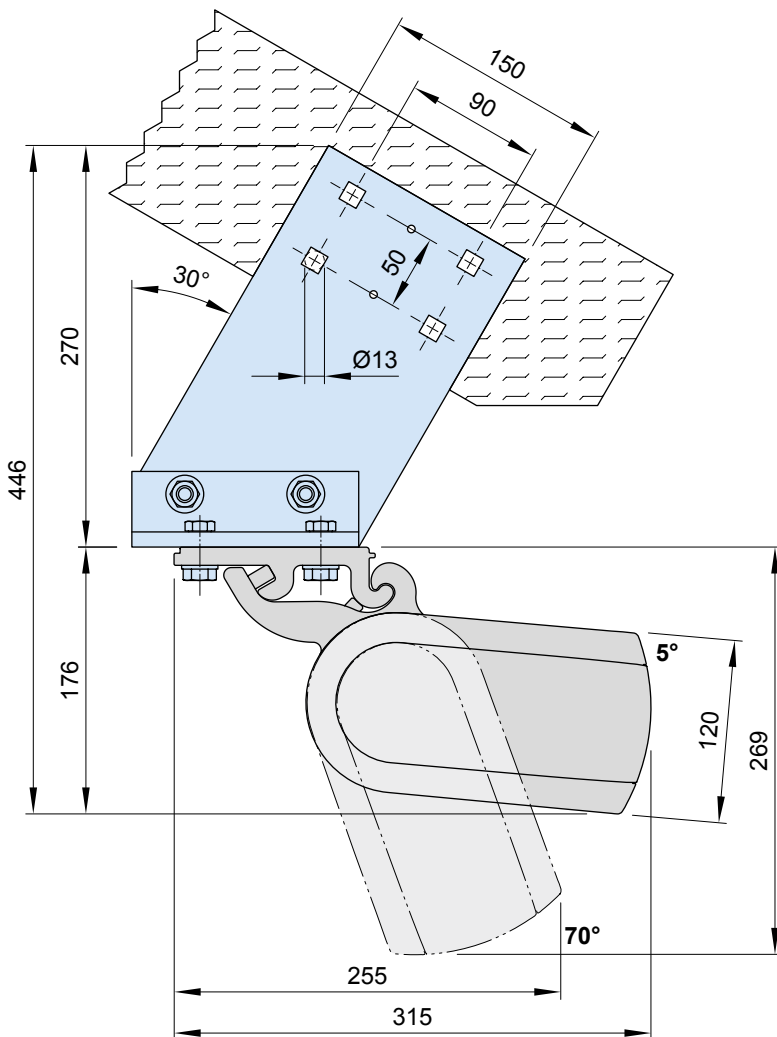

N.B! At a pitch of more than 46° to the horizontal there must be an area accessible behind the awning at least 60 cm deep to allow operation of an RTS motor with manual override.

dimensions in mm

Eaves fixture with additional plate

Fixtures, fittings and accessories

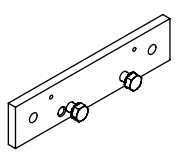

supplementary flat plate
for eaves fixture
260 × 60 × 12 mm

75383.

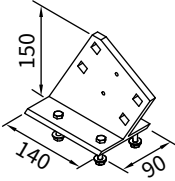

eaves fixture bracket
height of flat plate:
150 mm

75889.

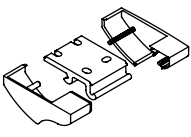

top fixture bracket
cover cap
left
100 mm

75887.

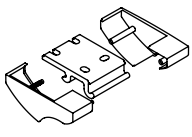

top fixture bracket
cover cap
right
100 mm

75888.

With eaves fixture bracket, top flat plate 150 mm (75889.)

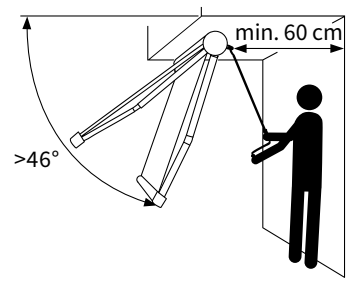
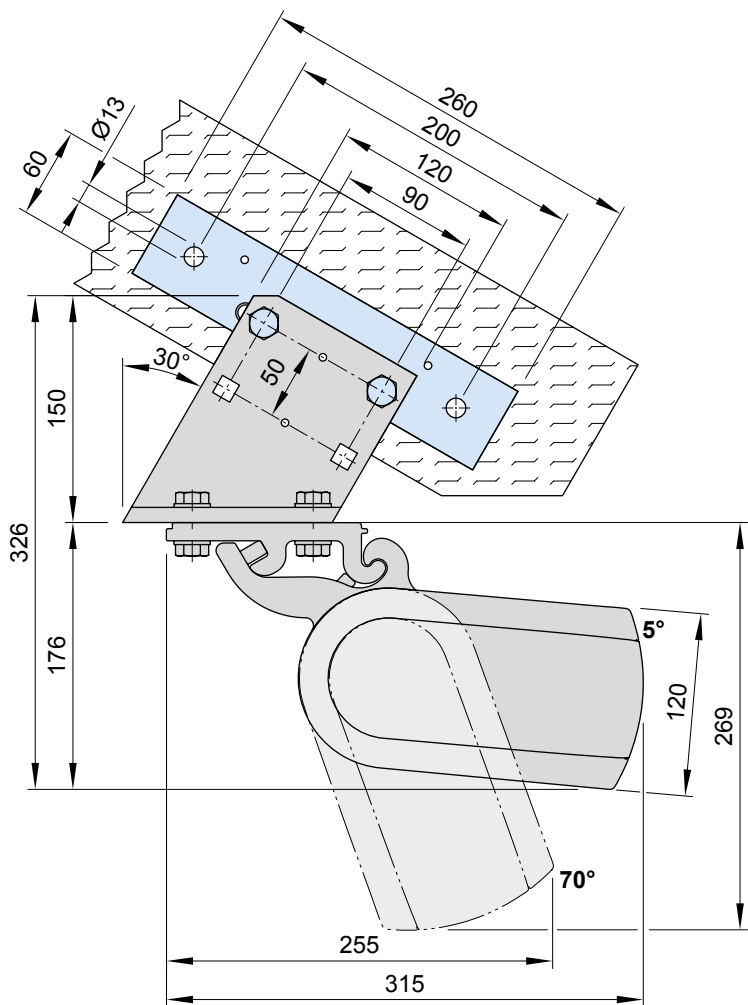

N.B! At a pitch of more than 46° to the horizontal there must be an area accessible behind the awning at least 60 cm deep to allow operation of an RTS motor with manual override.

dimensions in mm

01
02
03
04
05

01 Eaves fixture with additional plate

Fixtures, fittings and accessories

02
03
04
05

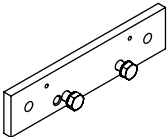

supplementary flat plate
for eaves fixture
260 × 60 × 12 mm

75383.

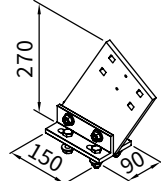

eaves fixture bracket

height of flat plate:
270 mm

71659.

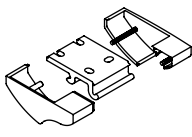

top fixture bracket
cover cap

left

100 mm

75887.

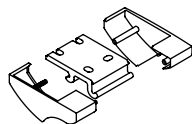

top fixture bracket
cover cap

right

100 mm

75888.

With eaves fixture bracket, top flat plate 270 mm (71659.)

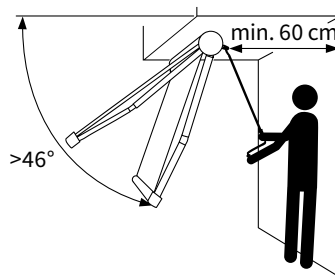
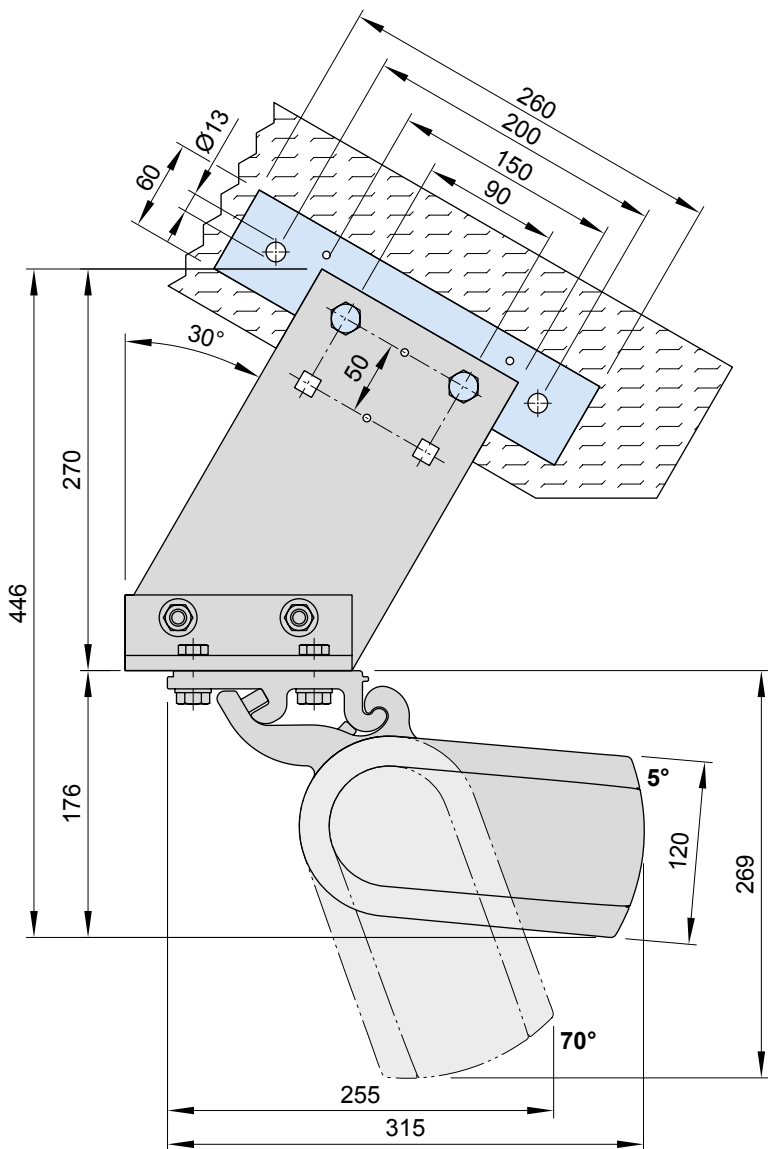

N.B! At a pitch of more than 46° to the horizontal there must be an area accessible behind the awning at least 60 cm deep to allow operation of an RTS motor with manual override.

dimensions in mm

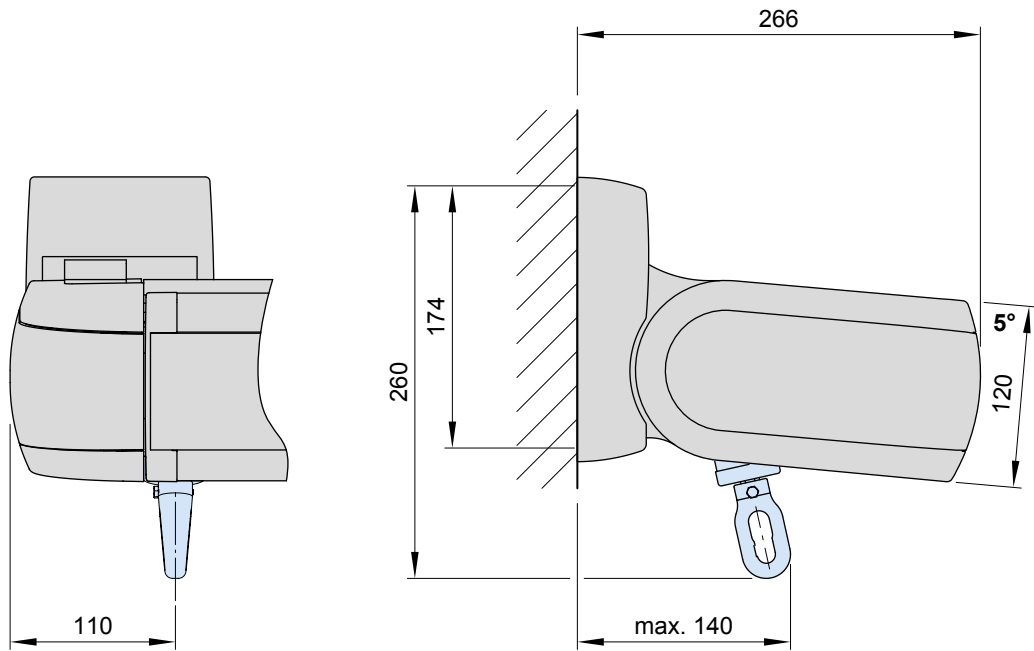
Face fixture, manual operation ¹⁾

01

02

03

04

05

Motor / lighting cable exit point ^{1) 2)}

Face fixture

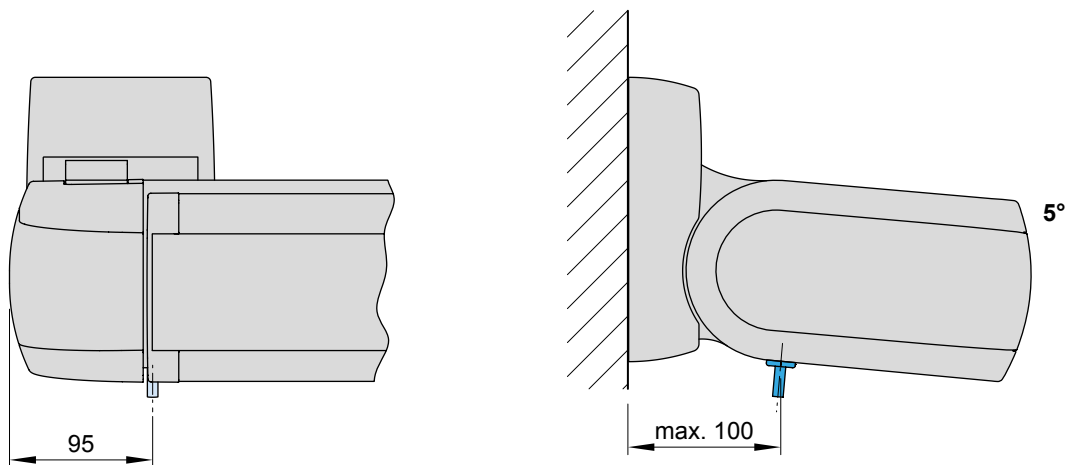

Top fixture

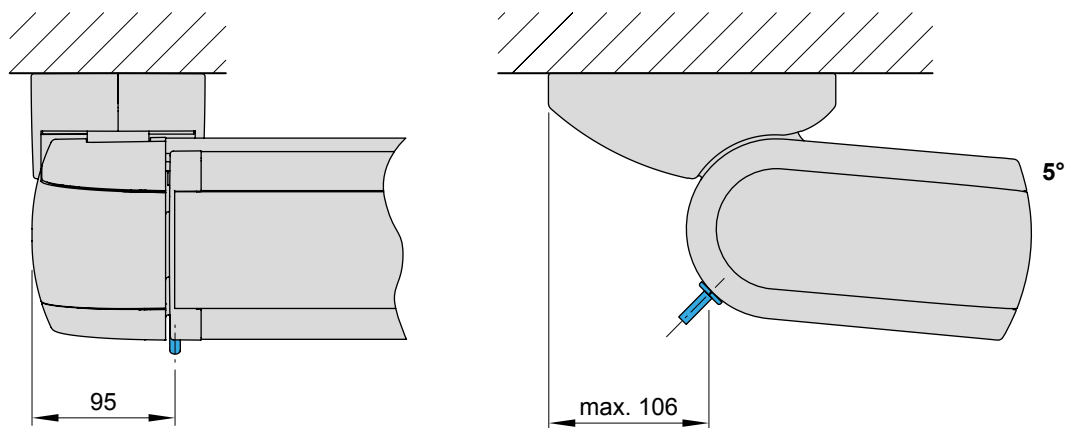
¹⁾ depending on the operation side, left or right²⁾ depending on the accessories ordered, one or two power supply cables (awning motor | lighting)

dimensions in mm

01

02

03

04

05