

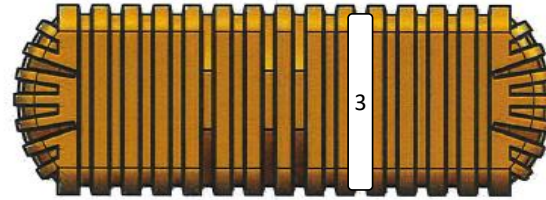

Valencia Pipe Company
 1500g Yellow Septic Tank Measurements & Specifications
 Model # 87-41760 (2 compartment)

Bottom View



All Wall Thicknesses:
 .255" +/- .07"

UV resistant BPA Free HDPE
 Empty weight: 458
 Shipping Class: 300
 Includes 2 4" tees and gaskets

Rib Detail

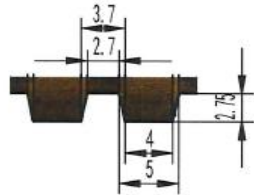

- MM** Manufacturer's Tank Markings (serial #, etc.)
- IM** Inlet Marking
- OM** Outlet Marking
- TI** Tank Information (min/max burial, etc.)

Inlet Side

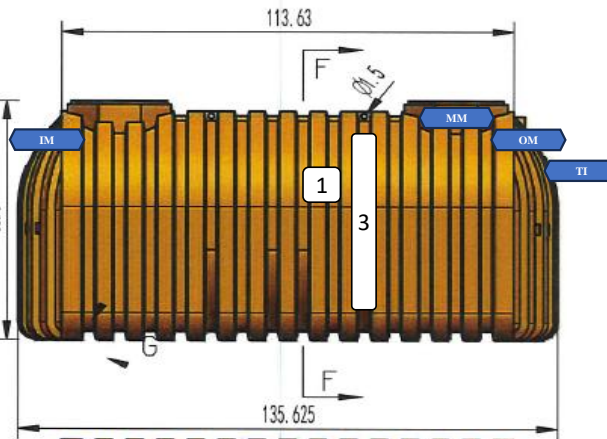
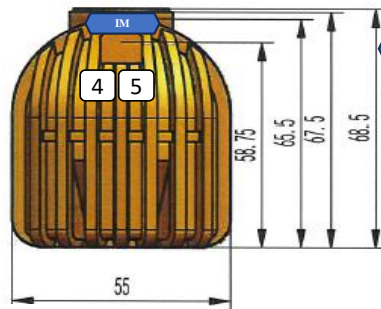

Operating Volume (Gls)
 Primary Compartment: 1006
 Secondary Compartment: 494

Municipal and County codes may vary from your state approval. Please make sure you consult with your local sanitation department or plumber on requirements.

Complies with FDA standards 21 CFR 177.1520 (1) 3.1 and 3.2
 3 year limited warranty

Outlet Side

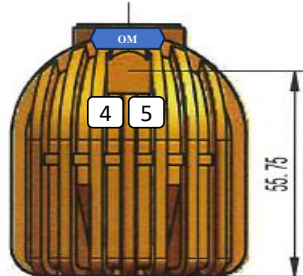

Item #	Mfgr Part #	Description	Qty
1	87-41760	1500 gallon two compartment HDPE septic tank	1
2	SPL-001	Black lid assembly	2
3	89-25100BL	1500g baffle	1
4	89-TB-4	4" Tee	2
5	89-SPL4G	4" Gasket	2

UNLESS OTHERWISE SPECIFIED: DIMENSIONS ARE IN INCHES SURFACE FINISH: TOLERANCES: LINEAR: ANGULAR:		FINISH:		DEBURR AND BREAK SHARP EDGES		DO NOT SCALE DRAWING		REVISION	
NAME		SIGNATURE		DATE		TITLE:			
DRAWN						87-41760 1500 GALLON TWO COMPARTMENT HDPE SEPTIC TANK			
CHKD									
APPV'D									
MFG									
QA									
				MATERIAL: High Density Polyethylene (HDPE)		WEIGHT: 458 lbs		SCALE: 5:1	
								SHEET: 1 OF 1	



Valencia Pipe Company
 1500g Yellow Septic Tank Measurements & Specifications
 Model # 87-41758 (1 compartment)

Rib Detail

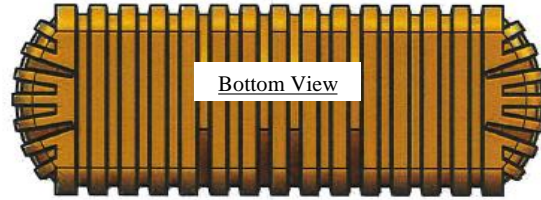
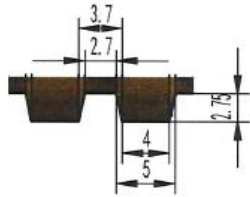

All Wall Thicknesses:
 .255" +/- .07"

UV resistant BPA Free HDPE
 Empty weight: 453
 Shipping Class: 300
 Includes 2 4" tees and gaskets

Inlet Side

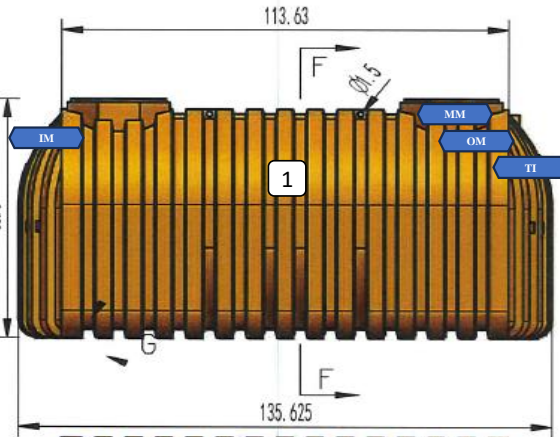
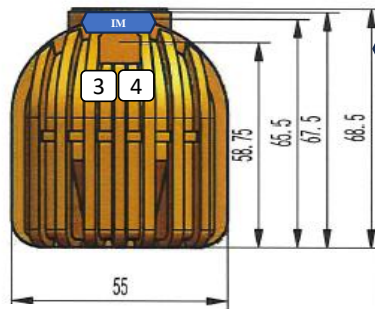

- MM Tank Information (min/max burial, etc.)
- TI Inlet Marking
- OM Outlet Marking
- TI Tank Information (min/max burial, etc.)

Outlet Side

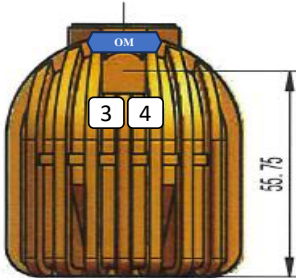

Municipal and County codes may vary from your state approval. Please make sure you consult with your local sanitation department or plumber on

Complies with FDA standards 21 CFR 177.1520 (1) 3.1 and 3.2
 3 year limited warranty

Item #	Mfgr Part #	Description	Qty
1	87-41758	1500 gallon one compartment HDPE	1
2	SPL-001	Black lid assembly	2
3	89-TB-4	4" Tee	2
4	89-SPL4G	4" Gasket	2

UNLESS OTHERWISE SPECIFIED: DIMENSIONS ARE IN INCHES SURFACE FINISH: TOLERANCES: LINEAR: ANGULAR:		FINISH:		DEBURR AND BREAK SHARP EDGES		DO NOT SCALE DRAWING		REVISION	
NAME		SIGNATURE		DATE		TITLE:			
DRAWN						87-41758 1500 GALLON ONE COMPARTMENT HDPE SEPTIC TANK			
CHKD									
APPV'D									
MFG									
QA									
MATERIAL: High Density Polyethylene (HDPE)						WEIGHT: 453 lbs		SCALE: 5:1	
								SHEET: 1 OF 1	



Valencia Pipe Company
 1000g Yellow Septic Tank Measurements & Specifications
 Model # 87-41720 (2 compartment)

Rib Detail

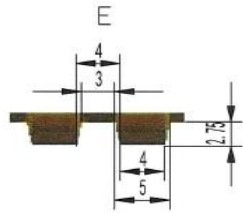

Bottom View

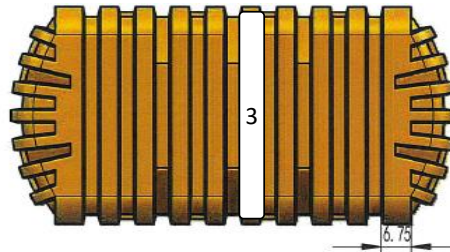

All Wall Thicknesses:
 .255" +/- .07"

UV resistant BPA Free HDPE
 Empty weight: 328
 Shipping Class: 300
 Includes 2 4" tees and gaskets

- MM** Manufacturer's Tank Markings (serial #, etc.)
- IM** Inlet Marking
- OM** Outlet Marking
- TI** Tank Information (min/max burial, etc.)

Inlet Side

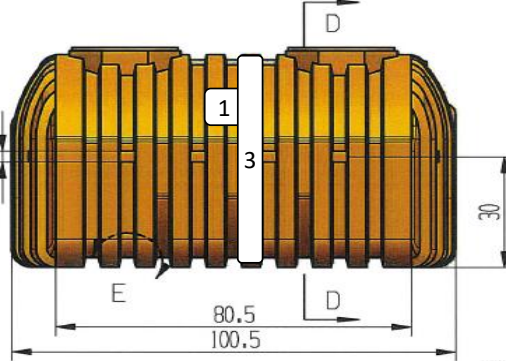
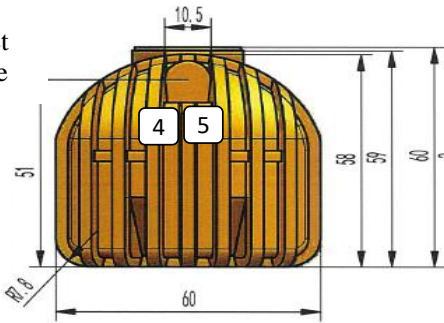

Outlet Side

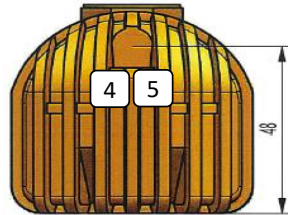

Top View

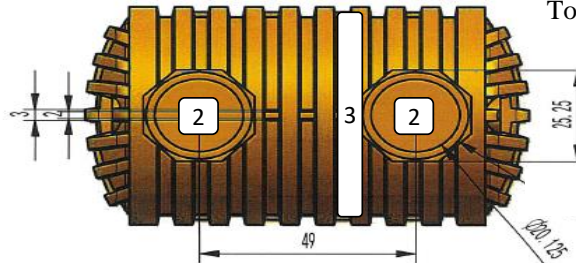

Operating Volume (Glns)

Primary Compartment: 670
 Secondary Compartment: 330

Municipal and County codes may vary from your state approval.
 Please make sure you consult with your local sanitation department or plumber on requirements.

Complies with FDA standards 21 CFR 177.1520 (1) 3.1 and 3.2
 3 year limited warranty

Item #	Mfgr Part #	Description	Qty
1	87-41720	1000 gallon two compartment HDPE septic tank	1
2	SPL-001	Black lid assembly	2
3	89-25100BL	1000g baffle	1
4	89-TB-4	4" Tee	2
5	89-SPL4G	4" Gasket	2

UNLESS OTHERWISE SPECIFIED: DIMENSIONS ARE IN INCHES SURFACE FINISH: TOLERANCES: LINEAR: ANGULAR:	FINISH:			DEBURR AND BREAK SHARP EDGES	DO NOT SCALE DRAWING		REVISION
	NAME				SIGNATURE	DATE	TITLE:
DRAWN				87-41720 1000 GALLON TWO COMPARTMENT HDPE SEPTIC TANK			
CHKD							
APPV'D							
MFG							
QA							
				MATERIAL: High Density Polyethylene (HDPE)			
				WEIGHT: 328 lbs		SCALE: 5:1	SHEET: 1 OF 1



Valencia Pipe Company
 1000g Yellow Septic Tank Measurements & Specifications
 Model # 87-41718 (1 compartment)

UV resistant BPA Free HDPE
 Empty weight: 323
 Shipping Class: 300
 Includes 2 4" tees and gaskets

All Wall Thicknesses:
 .255" +/- .07"

- MM Manufacturer's Tank Markings (serial #, etc.)
- IM Inlet Marking
- OM Outlet Marking
- TI Tank Information (min/max burial, etc.)

Municipal and County codes may vary from your state approval. Please make sure you consult with your local sanitation department or plumber on requirements.

Complies with FDA standards 21 CFR 177.1520 (1) 3.1 and 3.2
 3 year limited warranty

Item #	Mfgr Part #	Description	Qty
1	87-41718	1000 gallon one compartment	1
2	SPL-001	Black lid assembly	2
3	89-TB-4	4" Tee	2
4	89-SPL4G	4" Gasket	2

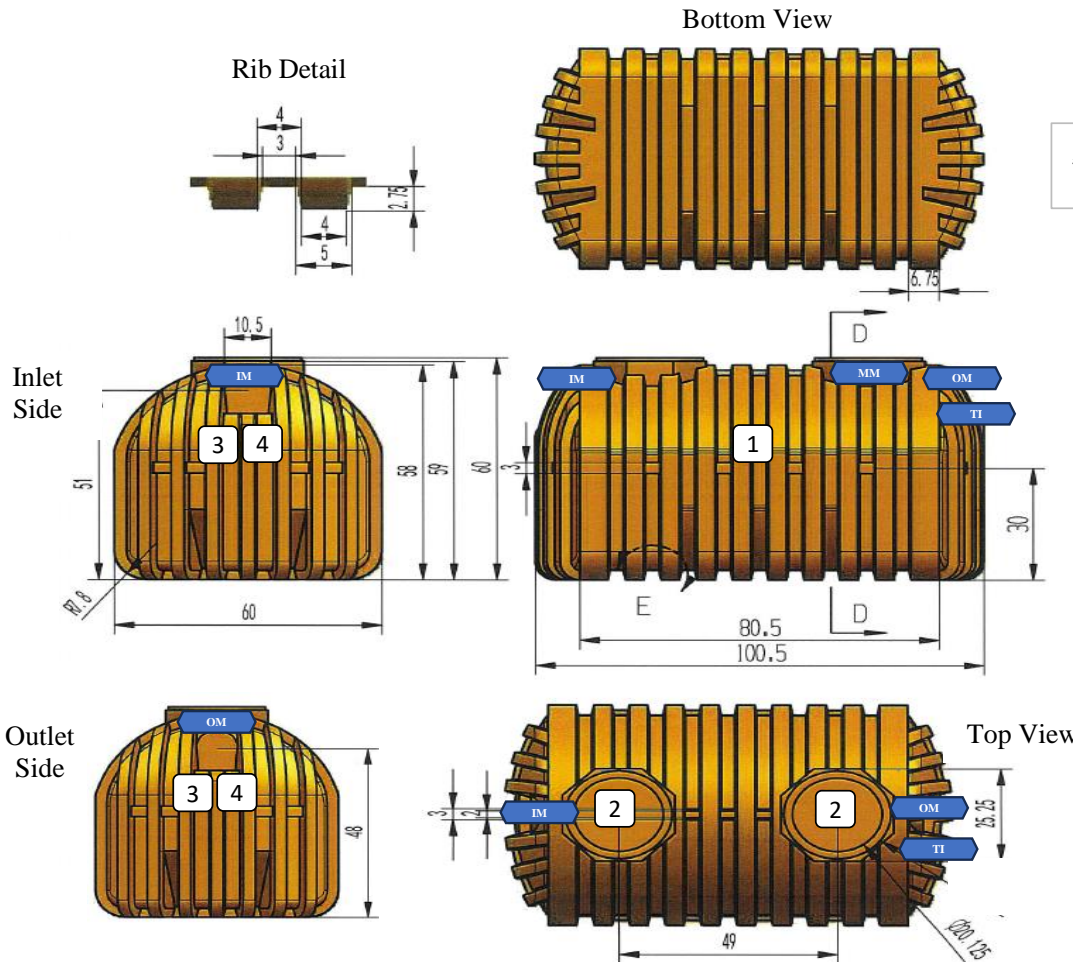

UNLESS OTHERWISE SPECIFIED: DIMENSIONS ARE IN INCHES SURFACE FINISH: TOLERANCES: LINEAR: ANGULAR:	FINISH:		DEBURR AND BREAK SHARP EDGES	DO NOT SCALE DRAWING		REVISION
	NAME	SIGNATURE	DATE	TITLE:		
DRAWN				87-41718 1000 GALLON ONE COMPARTMENT HDPE SEPTIC TANK		
CHKD						
APPV'D						
MFG						
QA				MATERIAL: High Density Polyethylene (HDPE)		
				WEIGHT: 328 lbs	SCALE: 5:1	SHEET: 1 OF 1



Valencia Pipe Company
 500g Yellow Septic Tank Measurements & Specifications
 Model # 87-41320

Bottom View

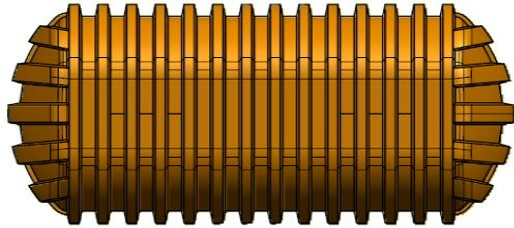

Inlet Side

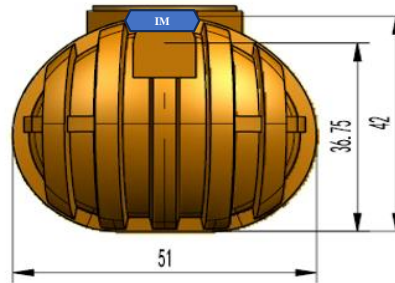

Rib Detail

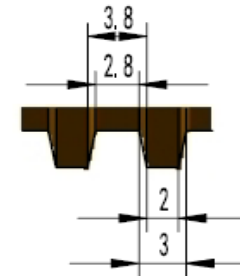

UV resistant BPA Free HDPE
 Empty weight: 172
 Shipping class: 300
 No 4" tees and gaskets included
 No Inlet or Outlet Holes

Side View

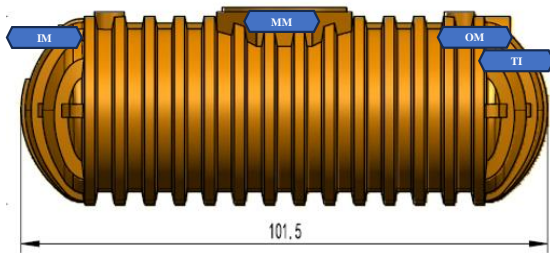

Outlet Side

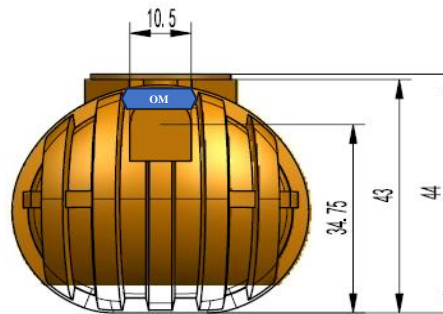

- MM Manufacturer's Tank Markings (serial #, etc.)
- IM Inlet Marking
- OM Outlet Marking
- TI Tank Information (min/max burial, etc.)

Top View

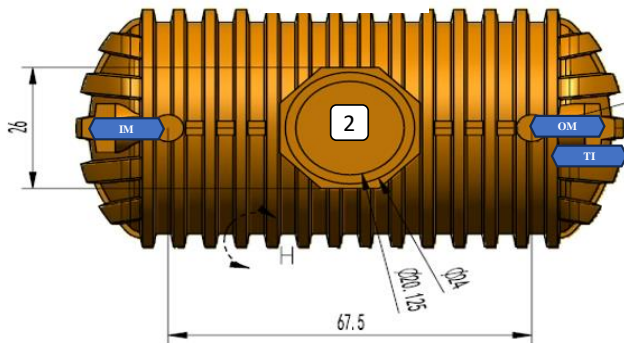

Municipal and County codes may vary from your state approval. Please make sure you consult with your local sanitation department or plumber on requirements.

Complies with FDA standards 21 CFR 177.1520 (1) 3.1 and 3.2
 3 year limited warranty

All Wall Thicknesses:
 .255" +/- .07"

Item #	Mfgr Part #	Description	Qty
1	87-41320	500 gallon one compartment HDPE septic tank	1
2	SPL-001	Black lid assembly	2

UNLESS OTHERWISE SPECIFIED: DIMENSIONS ARE IN INCHES SURFACE FINISH: TOLERANCES: LINEAR: ANGULAR:		FINISH:		DEBURR AND BREAK SHARP EDGES		DO NOT SCALE DRAWING		REVISION	
DRAWN		NAME		SIGNATURE		DATE		TITLE:	
CHKD								87-41320 500 GALLON ONE COMPARTMENT HDPE SEPTIC TANK	
APPV'D									
MFG									
QA								MATERIAL: High Density Polyethylene (HDPE)	
								WEIGHT: 172 lbs	
								SCALE: 5:1	
								SHEET: 1 OF 1	