

PMRO-0610

PERF METAL INFILL PATTERN

SS EDGING CR109DC

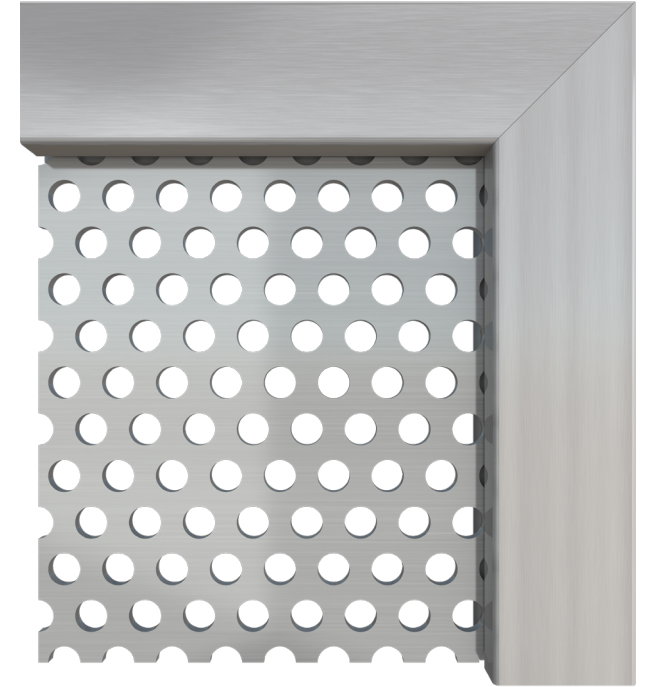
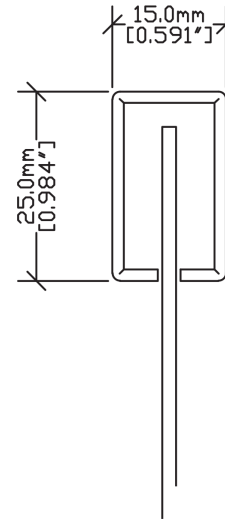
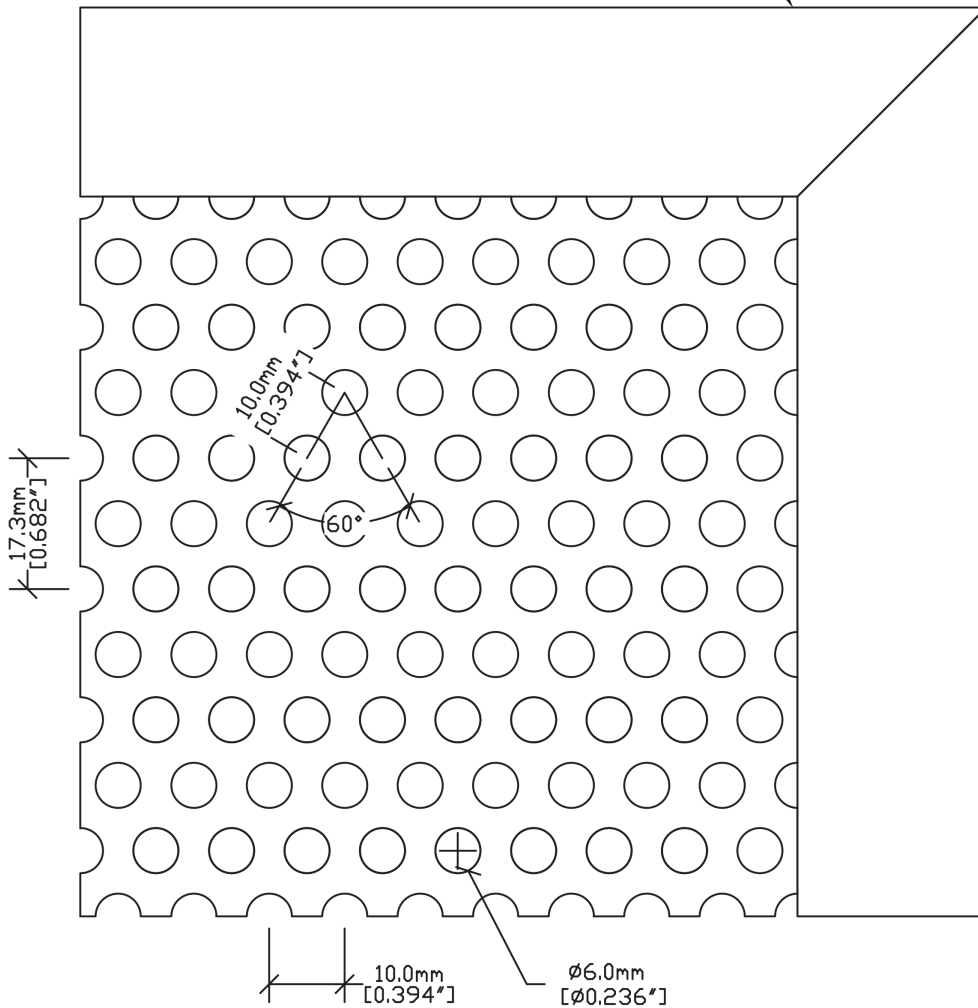

| | |
|----------------|------------------|
| PRODUCT CODE | PMRO-0610 |
| PATTERN TYPE | ROUND |
| SIZE X CENTERS | 6MM X 10MM |
| OPEN AREA | 40% |

PMRO-1014

PERF METAL INFILL PATTERN

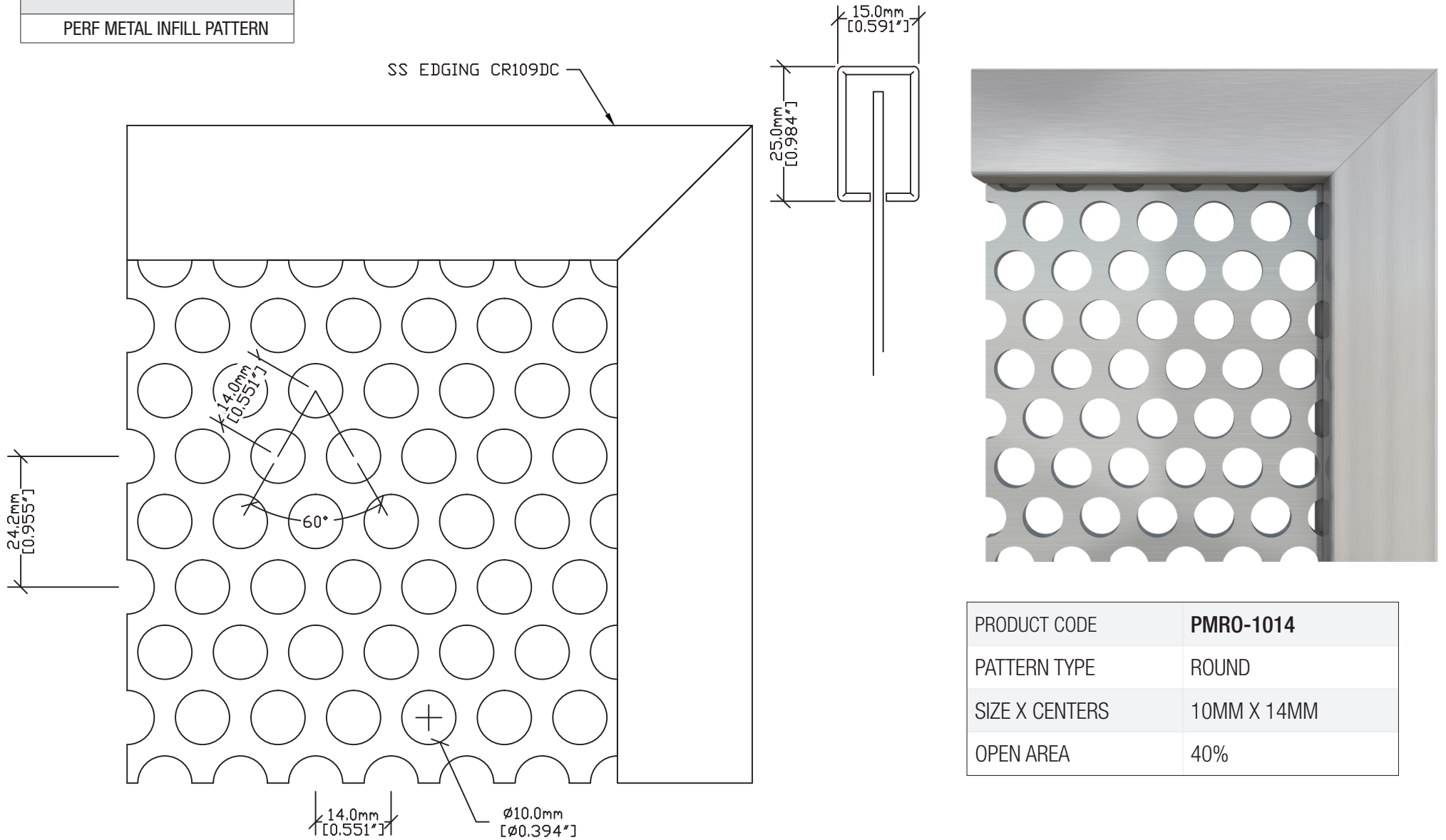

| | |
|----------------|------------------|
| PRODUCT CODE | PMRO-1014 |
| PATTERN TYPE | ROUND |
| SIZE X CENTERS | 10MM X 14MM |
| OPEN AREA | 40% |

PMRO-1217

PERF METAL INFILL PATTERN

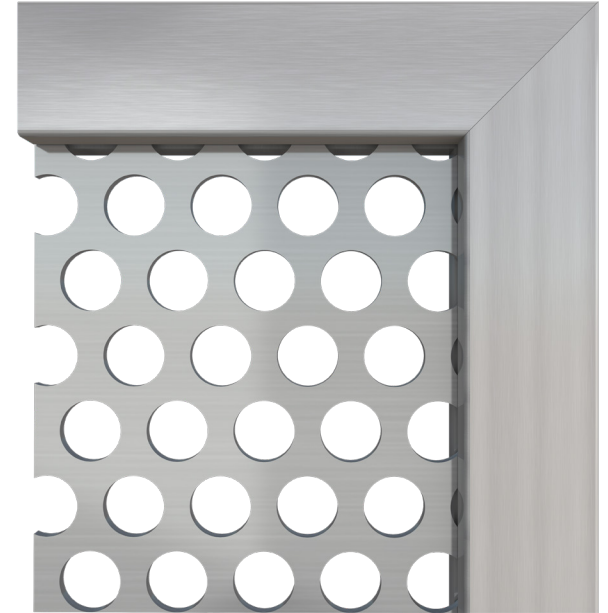
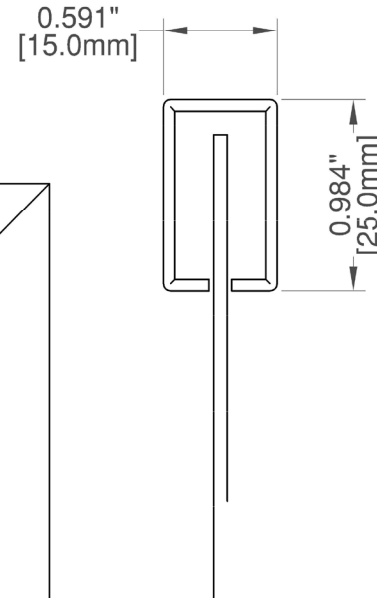
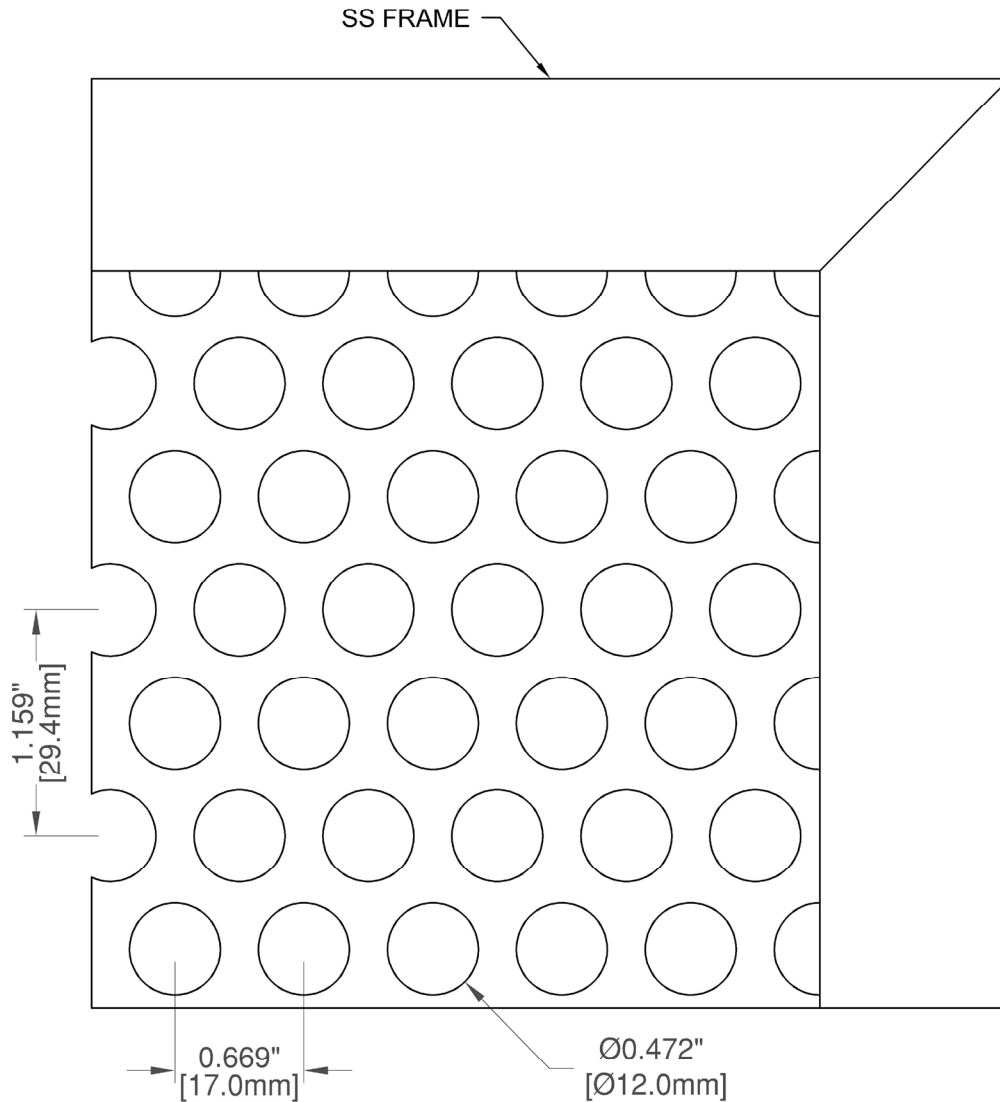

| | |
|----------------|------------------|
| PRODUCT CODE | PMRO-1217 |
| PATTERN TYPE | ROUND |
| SIZE X CENTERS | 17MM X 12 MM |
| OPEN AREA | 55% |

PMSL-0325

PERF METAL INFILL PATTERN

SS EDGING CR109DC

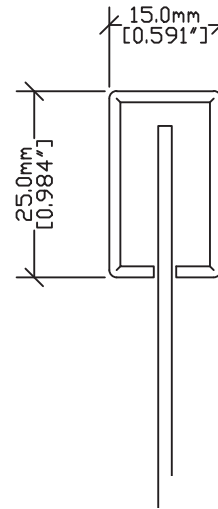
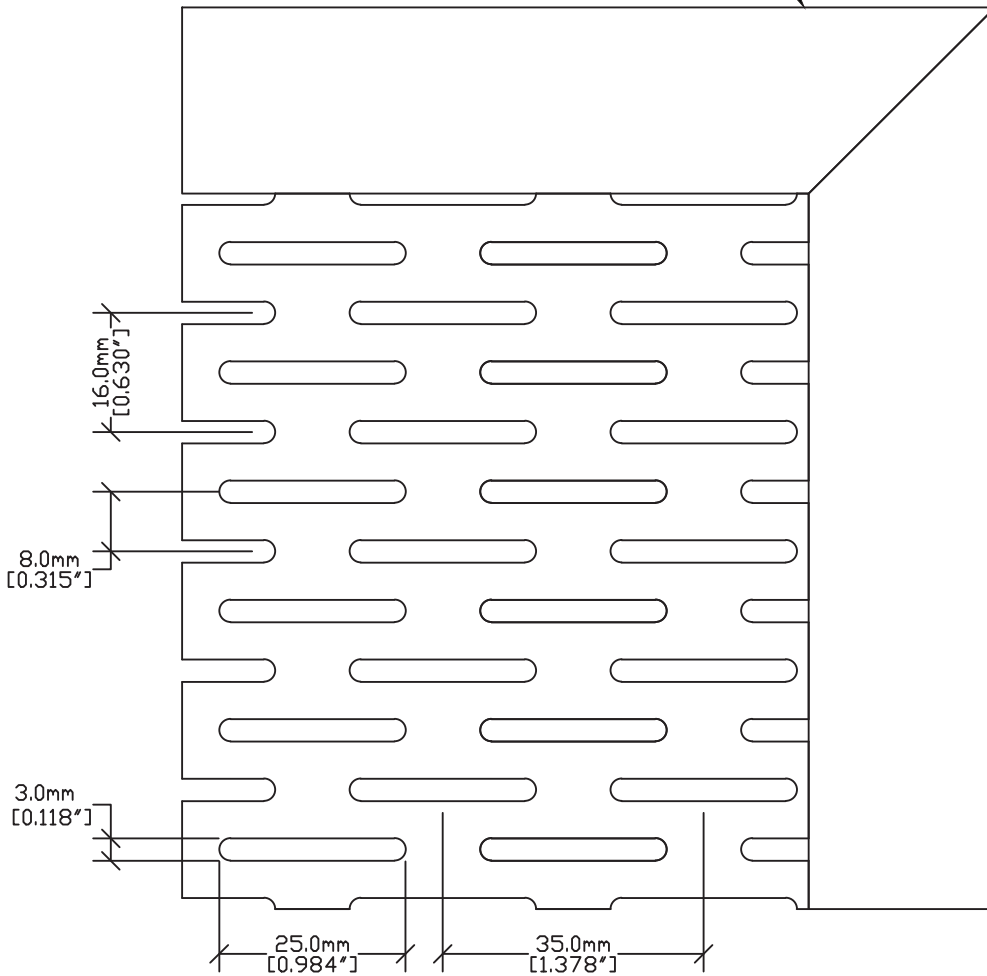

| | |
|----------------|------------------|
| PRODUCT CODE | PMSL-0325 |
| PATTERN TYPE | SLOTTED |
| SIZE X CENTERS | W 3.0 X L 25.0 |
| OPEN AREA | 43% |

PMSL-1122

PERF METAL INFILL PATTERN

SS EDGING CR109DC

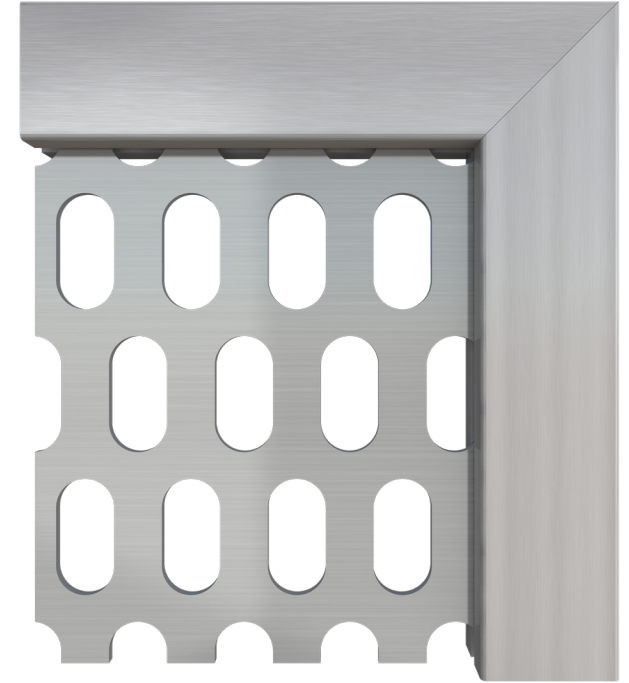
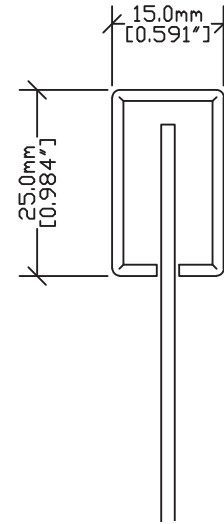
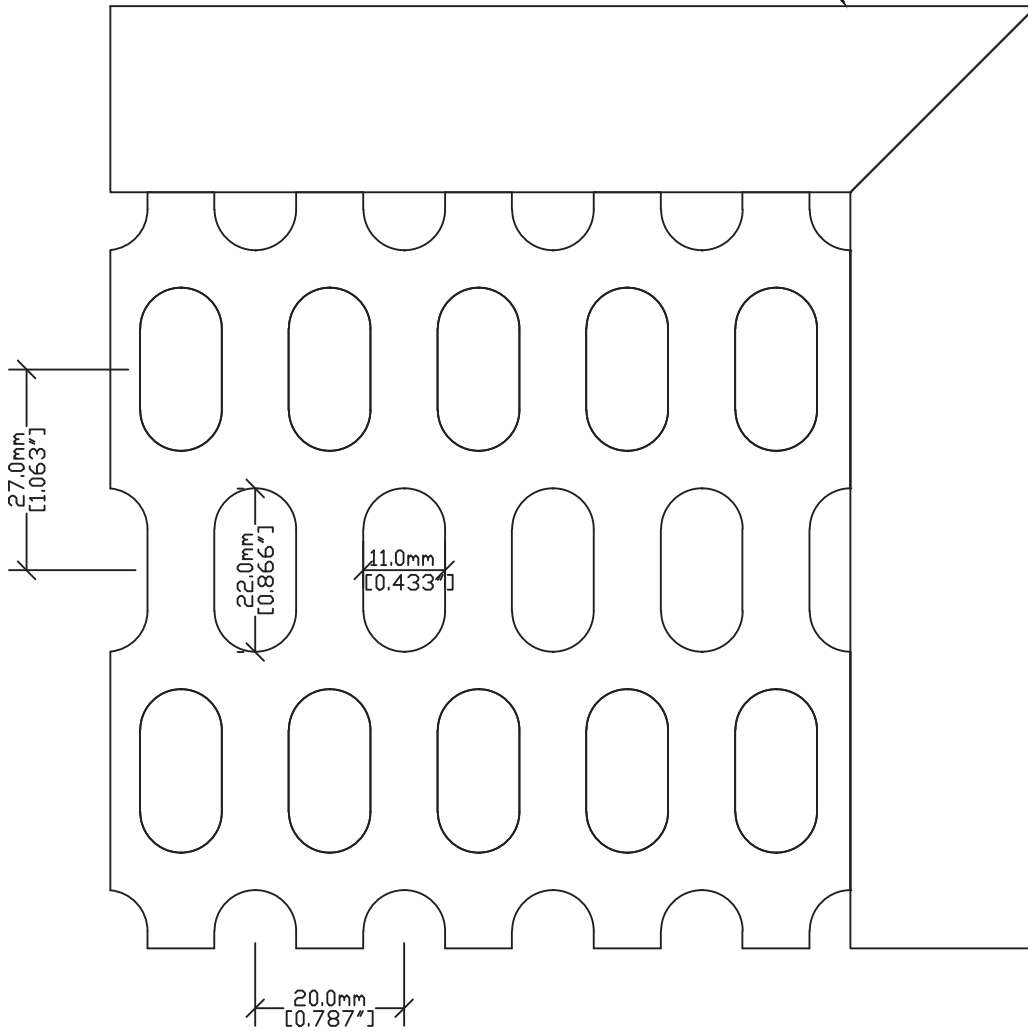

| | |
|----------------|------------------|
| PRODUCT CODE | PMSL-1122 |
| PATTERN TYPE | SLOTTED |
| SIZE X CENTERS | W 11.0 X L 22.0 |
| OPEN AREA | 39% |

PMSQ-1013

PERF METAL INFILL PATTERN

SS EDGING CR109DC

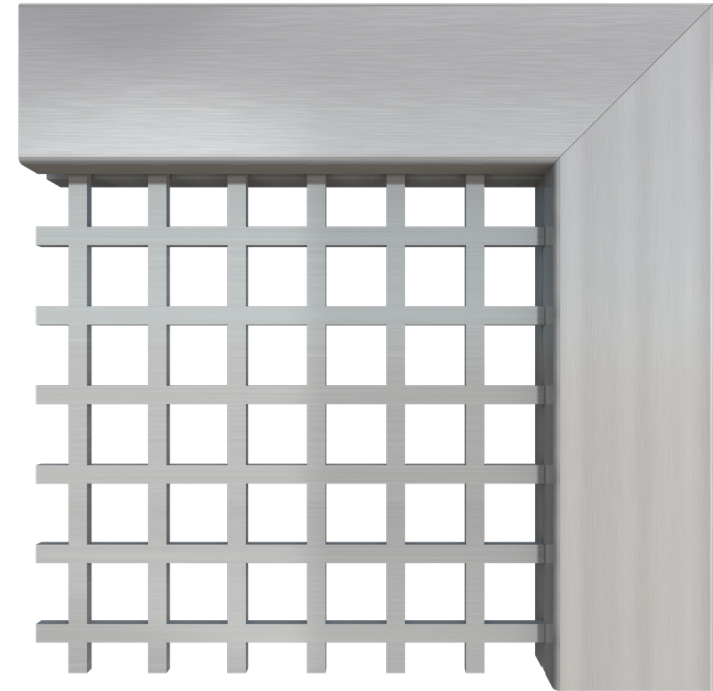
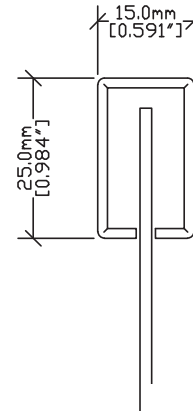
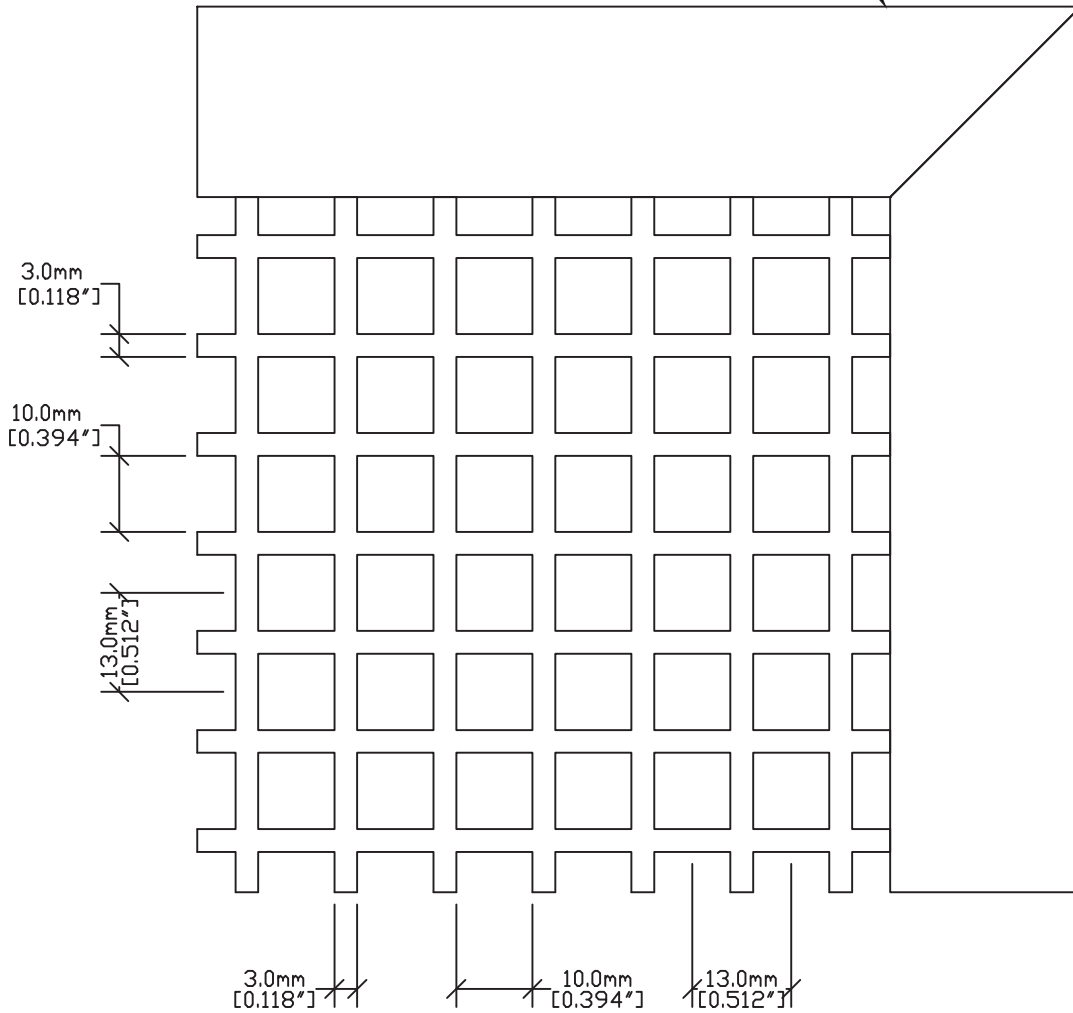

| | |
|----------------|------------------|
| PRODUCT CODE | PMSQ-1013 |
| PATTERN TYPE | SLOTTED |
| SIZE X CENTERS | 10MM X 13MM |
| OPEN AREA | 56% |